



Technical Memorandum for 340 West 31st Street, New York, New York
EAS and Negative Declaration
CEQR Number 10DCP033M
ULURP Number M120085AZSM
November 13, 2015

I. INTRODUCTION

On October 17, 2011, the New York City Planning Commission (CPC), as Lead Agency, issued a Negative Declaration for the project located at 340 West 31st Street (Manhattan, Block 754; Lot 63) (CEQR No. 10DCP033M and ULURP No. 110374 ZSM)¹ based on analyses identified in an Environmental Assessment Statement (EAS) completed in October 2011 (the “2011 EAS”). The 2011 EAS analyzed the environmental consequences from the Special Permit, which was granted on February 29, 2012 pursuant to Zoning Resolution (ZR) Sections 13-562 (Public Parking Garages and Public Parking Lots) and 74-52 (Parking Garages or Public Parking Lots in High Density Central Areas). The 2012 Special Permit facilitated the continued operation of a public parking garage and required a redesign of the garage and a build out in the rear yard in order to increase the number of parking spaces from 241 to 309 parking spaces. The 2012 Special Permit also approved drawings with a rear yard ramp. A public bicycle parking area for 32 bicycles would be located on the ground floor in the northeastern corner of the garage.

The current Department of Consumer Affairs license for the garage (#1181008) was issued on March 27, 2015 and expires on March 31, 2017 and allows a capacity of 255 cars, including 15 reservoir spaces. Although the 2012 Special Permit allow for 309 parking spaces, the proposed design in 2012 was never implemented. As a result, the garage has been operating with a capacity of 241 with 15 reservoir spaces since the granting of the 2012 Special Permit. The Applicant, Post Office Garage, LLC, is now seeking a minor modification to address the following concerns with regard to 2012 Special Permit:

- Costs associated with the 2012 Special Permit’s design of a new ramp in the rear and new 22-inch wide curb cuts on the western side of the lot are prohibitive.
- 60 of the 309 total approved parking spaces pursuant to the previously approved Special Permit are expected not to be needed.

¹ Considered concurrently with that action was a special permit (C 120085 ZSM) pursuant to ZR Section 74-54 to modify rear yard requirements of Section 33-292 (Required yards along district boundary coincident with rear lot lines of two adjoining zoning lots) to allow a 20-foot rear yard, 23 feet above curb level for the existing eight-story attended facility. The current regulations still require a rear yard of 30 feet up to a height of 23 feet above curb level for a zoning lot in a commercial district where the rear yard lot line of the zoning lot adjoins a residential district. The Applicant seeks to retain this rear yard modification.

- Reliance on the garage's existing ramp and reduced number of parking spaces would achieve the goal of lowering expenses and improving efficiency, promoting vehicle maneuverability, enhancing pedestrian safety, and relieving traffic congestion.
- The previously approved Special Permit design requires substantial expenditures that will not yield an increase in revenue and will require the garage to cease operation for at least 9 to 12 months during reconstruction.

To address the aforementioned concerns and to facilitate the continued operation of the garage, the CPC is now considering a minor modification to the 2012 Special Permit proposed by the Applicant. The modification being sought would alter the plans associated with the 2012 Special Permit pursuant to Section 74-52 (Parking Garages or Public Parking Lots in High Density Central Areas) of the Zoning Resolution to allow a decrease in the approved number of parking spaces from 309 to 249 and design changes to the parking facility. The requested modification plans include the reconfiguration of the parking spaces and ground floor to accommodate changes to the existing curb cuts and interior ramp configuration, pedestrian walk zone, a 1,136 square foot storage area, and streetscape improvements. Existing conditions are highlighted on Existing Site Plan A-001.00 and A-003.00. The proposed modifications are highlighted on Proposed Modification Drawings A-002.00 and A-004.00.

This technical memorandum evaluates whether the project with the proposed modification would result in any significant adverse impacts not already identified in the 2011 EAS. As disclosed in this technical memorandum, the proposed modification would neither alter the conclusions of the 2011 EAS or Negative Declaration, nor result in any significant adverse impacts.

II. DESCRIPTION OF PROPOSED MODIFICATION

Existing Conditions

The Project Site is located at 340 West 31st Street (Block 754; Lot 63), an approximately 9,875 square-foot midblock lot with frontage on the south side of West 31st Street, between Eighth and Ninth Avenues in Manhattan Community District 4 in the Chelsea neighborhood of Manhattan. The Project Site is currently occupied by a 81,040 gsf detached eight-story public parking facility with two below-grade levels and roof parking. The Project Area has a 20' deep rear yard currently used as six parking spaces. A 79'-2"-wide curb cut exists on the western side of the lot which allows access for one 10' entrance lane and one 10' egress lane and pedestrian traffic. The interior ramp to the second floor is 15'11" wide and located east of the parking office and man elevator #1. Streetscape improvements have not been implemented with this current configuration.

The current Department of Consumer Affairs license for the garage (#1181008) was issued on March 27, 2015 and expires on March 31, 2017 and allows a capacity of 255 cars, including 15

reservoir spaces. Although the 2012 Special Permit allow for 309 parking spaces, the proposed design in 2012 was never implemented.

Previously Analyzed Project as Analyzed in the 2011 EAS

The action analyzed in 2011 was a Special Permit pursuant to Sections 13-562 and 74-52 of the Zoning Resolution of the City of New York to facilitate the continued operation of an attended public parking garage with a maximum capacity of 309 public spaces within the existing 8-story garage building. The 2012 Special Permit facilitated the continued operation of a public parking garage and required a redesign of the garage and a build out in the rear yard in order to increase the number of parking spaces from 241 to 309 parking spaces.

There was no physical expansion of the envelope of the existing garage building. The Special Permit allowed for the reconfiguration of the ground floor to allow modifications to curb cuts and the interior ramp configuration, new ground-level bicycle parking, and streetscape improvements. Figures A-4a through A-4e the site plans for the Special Permit modifications.

Although the 2012 Special Permit allow for 309 parking spaces, the proposed design in 2012 was never implemented.

Project with Proposed Modification

The Applicant seeks a modification to the 2012 Special Permit pursuant to Sections 13-562 and 74-52 of the Zoning Resolution of the City of New York to permit an attended public parking garage with a maximum capacity of 309 public spaces within the existing 8-story garage building.

The proposed reconfiguration of parking spaces will include 249 parking spaces with 12 reservoir parking spaces as per Manhattan Core Parking (N130105 ZRM, Enacted 5/8/2013).

The reconfiguration of the ground floor will include a modification to the existing curb cuts and the interior ramp configuration, pedestrian walk zone, a 1,136 square foot storage area, and streetscape improvements. Modifications for the ground floor are detailed below.

- Modification of existing curb cuts and interior ramp configuration:

The proposed action would divide the existing 79-foot curb cut into two separate curb cuts of 30-feet and 10-feet wide curb cuts. The 30-foot curb cut would provide access to one 10-foot, one 11-foot wide entrance lanes, and one 10-foot wide exit lane. The 10-foot curb cut would provide access to a separate 10-foot exit lane. Existing conditions are highlighted on Existing Site Plan A-001.00. The proposed modification is highlighted on Proposed Modification Drawing A-002.00.

- Pedestrian walk zone
A pedestrian walk zone will be added to the ground floor between the two proposed exit ramps expanding the existing waiting area to the West 31st Street sidewalk. The existing condition of this portion of the garage is highlighted on Existing Site Plan A-003.00. The proposed pedestrian walk zone is highlighted on Proposed Modification Drawing A-004.00.
- Rear Yard Storage area
A 1,136 square foot storage area is proposed in the southeast corner of the ground floor level in an area of six existing parking spaces. The existing condition of this portion of the garage is highlighted on Existing Site Plan A-003.00. The proposed rear yard storage area is highlighted on Proposed Modification Drawing A-004.00.
- Streetscape improvements
Streetscape improvements that would occur on West 31st Street in front of the garage would be sidewalk trees in areas of the former curb cut not included in the proposed curb cut configuration. Existing conditions are highlighted on Existing Site Plan A-001.00. The proposed modification is highlighted on Proposed Modification Drawing A-002.00.

There would be no physical expansion of the envelope of the Existing Garage building in the future with the Proposed Action and the Proposed Garage would remain identical in parking configuration as the Existing Garage, except for the reconfiguration of the ground floor to allow modifications to curb cuts, the interior ramp configuration, and streetscape improvements. Further, there would be no increase in parking demand at the Project Site as a result of the proposed increase in permitted capacity. As previously discussed, the present garage would be improved to current standards with features including at-grade bicycle parking and sidewalk trees.

III. POTENTIAL IMPACTS OF THE PROPOSED MODIFICATION

The current Department of Consumer Affairs license for the garage (#1181008) was issued on March 27, 2015 and expires on March 31, 2017 and allows a capacity of 255 cars, including 15 reservoir spaces. Although the 2012 Special Permit allow for 309 parking spaces, the proposed design in 2012 was never implemented. As a result, the garage has been operating with a capacity of 241 with 15 reservoir spaces since the granting of the 2012 Special Permit.

The Applicant, Post Office Garage, LLC, is now seeking a minor modification to address the following concerns with regard to 2012 Special Permit. The applicant has identified that costs associated with the 2012 Special Permit's design of a new ramp in the rear and new 22-inch wide curb cuts on the western side of the lot reliance on the garage's existing ramp are prohibitive, 60 of the 309 total approved parking spaces pursuant to the previously approved Special Permit are expected not to be needed, the reduced number of parking spaces would achieve the goal of



lowering expenses and improving efficiency, promoting vehicle maneuverability, enhancing pedestrian safety, and relieving traffic congestion. Additionally, the previously approved Special Permit design requires substantial expenditures that will not yield an increase in revenue and will require the garage to cease operation for at least 9 to 12 months during reconstruction.

To address the aforementioned concerns and to facilitate the continued operation of the garage, the CPC is now considering a minor modification to the 2012 Special Permit proposed by the Applicant. The modification being sought would alter the plans associated with the 2012 Special Permit pursuant to Section 74-52 (Parking Garages or Public Parking Lots in High Density Central Areas) of the Zoning Resolution to allow a decrease in the approved number of parking spaces from 309 to 249 and design changes to the parking facility.

Although the 2012 Special Permit allow for 309 parking spaces, the proposed design in 2012 was never implemented. Therefore, potential impacts of the proposed modification have been evaluated based on proposed changes to the existing conditions of the garage.

The Project Site is currently occupied by a 81,040 gsf detached eight-story public parking facility with two below-grade levels and roof parking. There are currently 241 parking spaces and 15 reservoir spaces utilized in the existing condition. The Project Area has a 20' deep rear yard currently used as six parking spaces. A 79'-2"-wide curb cut exists on the western side of the lot which allows access for one 10' entrance lane and one 10' egress lane and pedestrian traffic. The interior ramp to the second floor is 15'11" wide and located east of the parking office and man elevator #1. Streetscape improvements have not been implemented with this current configuration.

The requested modification plans include the reconfiguration of the parking spaces and ground floor to accommodate changes to the existing curb cuts and interior ramp configuration, pedestrian walk zone, a 1,136 square foot storage area, and streetscape improvements. Existing conditions are highlighted on Existing Site Plan A-001.00 and A-003.00. The proposed modifications are highlighted on Proposed Modification Drawings A-002.00 and A-004.00.

The potential effect of the proposed modifications is summarized below.

	Existing Condition		No Action Scenario		Proposed Project		Increment	
Parking	Parking	reservoir Space	Parking	reservoir Space	Parking	reservoir Space	Parking	reservoir Space
	241	15	241	15	249	12	+8	-3
Storage Area	0 sqft		0 sqft		1,136 sqft		+1,136 sqft	



Screening Analysis

The following CEQR technical areas that are sensitive to bulk, site-based effects, and/or density can be screened out from requiring further analysis: Land Use, Zoning, and Public Policy (although a description of land use, zoning, and public policy is provided below for informational purposes); Socioeconomic Conditions; Community Facilities and Services; Open Space; Shadows; Urban Design and Visual Resources; Natural Resources; Hazardous Materials; Water and Sewer Infrastructure; Solid Waste and Sanitation Services; Energy; Greenhouse Gas Emissions and Climate Change; Noise (stationary sources); Public Health; and Neighborhood Character. No further analysis of these areas is provided, although a discussion of land use, zoning, and public policy is provided for informational purposes.

Land Use

Project Area

The Project Area is located at 340 West 31st Street, Block 754, Lot 63, in Manhattan's Chelsea neighborhood on the south side of West 31st Street between Eight and Ninth Avenues, in Community Board No. 4. The lot area is 9,875 square feet, with 100' of frontage on West 31st Street, and a depth of 98'-9". The Project Area is zoned C6-3X which allows a commercial floor area ratio (FAR) of 6.0.

The Project Area is currently used as a public parking garage. The garage consists of a subcellar, cellar and eight stories and contains 241 parking spaces plus 15 reservoir spaces. Total square footage of existing zoning floor area parking is 43,052, including parking on the roof. The Project Area has a 20' deep rear yard. A 79'-2"-wide curb cut exists on the western side of the lot.

The garage's current Certificate of Occupancy (CO) No. 72863 is dated January 10, 1973. The CO authorizes a Use Group 8 public parking garage consisting of 8 stories with attended parking on each story from the subcellar to the roof (including an office on the 1st floor) for 241 cars plus reservoir space for 15 cars. The current Department of Consumer Affairs license No. 1181008-DCA was issued on March 27, 2015 and expires on March 31, 2017. The license allows a capacity of 255 cars.

The Applicant proposes to continue to use the public parking garage pursuant to requested minor modifications of the 2012 special permit. The Application requests a modification of the special permit to: 1) use the existing ramp within the garage instead of constructing a ramp extension in the rear yard that was approved as part of the 2012 special permit; 2) reduce the total number of parking spaces approved under the 2012 special permit from 309 spaces to 249 spaces; 3) reduce the amount of reservoir area approved under the 2012 special permit from 15 spaces to 12 spaces; and 4) reduce the total curb cut width approved in the special permit from two 22'-wide curb cuts on the western portion of the lot to one 30'-wide curb cut and one 10'-wide curb cut relocated to the center of the lot. The envelope of the parking garage structure would remain unchanged.



Moreover, it is more practical and efficient to use the existing ramp than to build a new ramp that extends into the rear yard as approved by the 2012 special permit. In addition, a reduction in number of spaces would eliminate unnecessary parking spaces. The reduction in spaces will allow for more efficient movement thorough out the garage. The reduction in required reservoir spaces from 15 to 12 will also reduce traffic flow in the garage and across the sidewalk and will decrease congestion at the West 31st Street entrance.

The remaining proposed changes are very minor and include the relocation of the storage area from the cellar to the first floor to facilitate access to repair and emergency equipment.

The proposed bulk of the garage is 81,040 square feet in gross floor area (41,090 square feet of zoning floor area). The proposed height of the 8-story garage is 70'-5". Proposed open space is 2,000 square feet at the rear yard. The proposed east curb cut is 20' wide and 422' from Eighth Avenue. The proposed west curb cut is 20' wide and 358' from Ninth Avenue.

Surrounding Area

The Project Area is located in Community Board No. 4 in the Chelsea neighborhood of the Borough of Manhattan. The area approximately 600' beyond the edge of the Project Area boundary (the "Surrounding Area") contains a mix of uses, with West 31st Street being predominantly commercial and institutional.

To the north of the Project Site is the individually-landmarked James A. Farley Post Office on 8th Avenue at West 31st Street, located directly across the street from the Project Area. Also located north of the Project Area are two large entertainment venues: Madison Square Garden, between West 31st and West 33rd Streets and a multi-screen movie theater on West 34th Street between 8th and 9th Avenues.

The south side of the block on which the Project Area is located, and the majority of Block 753 to the south of the Project Area's block is designated an R8B zoning district and is almost entirely composed of smaller residential buildings of four stories or less. Farther south of the Project Area is a predominantly residential area that includes the Penn South Houses. To the southwest is the USPS Morgan Processing and Distribution Center, occupying the entire Block 727.

The area to the east and west of the Project Area's block contains some manufacturing buildings. Areas to the north, northeast and northwest are designated as C6-4 commercial districts and contain high-density commercial uses. To the east and west are large office buildings, including One Penn Plaza, located between 33rd Street and 34th Street, west of Seventh Avenue, and Two Penn Plaza, located on 7th Avenue between West 31st and West 33rd Streets. Penn Station, located to the northeast of the Project Area, is a major transportation hub serving over a half-million passengers daily in the central business district. The Fashion Institute of Technology's Kaufman



Hall houses approximately 1,100 students and is located to the west of the Project Area on Block 278, between 9th Avenue and Dyer Avenue on West 31st Street.

Within a 600' boundary of the Project Area, at 371 9th Avenue and 401-409 9th Avenue, Manhattan, CPC approved certifications on May 1, 2015 pursuant to ZR § 93-122(b) to allow a building containing residences to be developed without the minimum amount of commercial floor area, pursuant to ZR § 93-732 for a public access area on the Ninth Avenue Rail Yard and pursuant to ZR § 93-131(a)(2) for office use within the Hudson Yards Redevelopment Area.

On October 13, 2009, the Landmark Preservation Commission designated the Lamartine Place Historic District, comprising 12 buildings located on the north side of West 29th Street between 8th and 9th Avenues. Boundary lines of the Hudson Yards Special District extend along 9th Avenue and West 31st Street, northwest and north of the Project Area.

Mass transportation in the Surrounding Area includes Amtrak, LIRR, NJ Transit service at Penn Station as well as MTA subway lines for the A, C, E, 1, 2, 3 trains at 34th Street- Penn Station. MTA bus service consists of the northbound No. 20 bus along 8th Avenue, the southbound No. 20 and No. 7 buses along 7th Avenue, and the crosstown No. 34 along 34th Street. Westbound street traffic on West 31st Street connects with the Lincoln Tunnel Approach at Dyer Avenue.

Zoning

Project Area

The Project Area is located within a C6-3X zoning district in Community Board No. 4 and the Manhattan Core. The Project Area is zoned C6-3X which allows a commercial floor area ratio (FAR) of 6.0.

The action analyzed in 2011 was a Special Permit pursuant to Sections 13-562 and 74-52 of the Zoning Resolution of the City of New York to facilitate the continued operation of an attended public parking garage with a maximum capacity of 309 public spaces within the existing 8-story garage building. Considered concurrently with that action was a special permit (C 120085 ZSM) pursuant to ZR Section 74-54 to modify rear yard requirements of Section 33-292 (Required yards along district boundary coincident with rear lot lines of two adjoining zoning lots) to allow a 20-foot rear yard, 23 feet above curb level for the existing eight-story attended facility. The current regulations still require a rear yard of 30 feet up to a height of 23 feet above curb level for a zoning lot in a commercial district where the rear yard lot line of the zoning lot adjoins a residential district. The Applicant seeks to retain this rear yard modification.

Surrounding Area

The area approximately 600' beyond the edge of the Project Area boundary (the "Surrounding Area") contains a mix of uses, with West 31st Street being predominantly commercial and institutional.



To the north of the Project Site is the individually-landmarked James A. Farley Post Office on 8th Avenue at West 31st Street, located directly across the street from the Project Area. Also located north of the Project Area are two large entertainment venues: Madison Square Garden, between West 31st and West 33rd Streets and a multi-screen movie theater on West 34th Street between 8th and 9th Avenues.

The south side of the block on which the Project Area is located, and the majority of Block 753 to the south of the Project Area's block is designated an R8B zoning district and is almost entirely composed of smaller residential buildings of four stories or less.

The area to the east and west of the Project Area's block contains some manufacturing buildings. Areas to the north, northeast and northwest are designated as C6-4 commercial districts and contain high-density commercial uses.

Within a 600' boundary of the Project Area, at 371 9th Avenue and 401-409 9th Avenue, Manhattan, CPC approved certifications on May 1, 2015 pursuant to ZR § 93-122(b) to allow a building containing residences to be developed without the minimum amount of commercial floor area, pursuant to ZR § 93-732 for a public access area on the Ninth Avenue Rail Yard and pursuant to ZR § 93-131(a)(2) for office use within the Hudson Yards Redevelopment Area.

Public Policy

There are no adopted City policies, as defined in the 2014 *CEQR Technical Manual*, applicable to the development site or the 600-foot radius study area.

Transportation

The 2011 EAS assessed transportation according to the 2010 *CEQR Technical Manual* which identified minimum development densities that potentially require transportation analysis. Development at less than the development densities shown in Table 16-1 of the 2010 *CEQR Technical Manual* generally result in fewer than 50 peak hour vehicle trips, 200 peak hour subway/rail or bus transit riders, and 200 peak hour pedestrian trips, where significant adverse impacts are considered unlikely. For off-street parking facilities, the threshold in Zone 1 (which includes Manhattan south of 110th Street) is 85 new spaces (compared to No-Action conditions), which the 309-space garage facilitated by the previously analyzed project exceeded. Therefore, a Level I Screening Assessment was completed and included in the 2011 EAS.

The proposed modification would increase the number of parking spaces from 241 to 249, an increase of eight spaces and decrease the reservoir parking spaces from 15 spaces to 12 spaces, a decrease of three reservoir spaces. As per Table 16-1 of the 2014 *CEQR Technical Manual* fewer than 50 peak hour vehicle trips (with "trips" referring to trip-ends), 200 peak hour subway/rail or bus transit riders and 200 peak hour pedestrian trips, where significant adverse impacts are

generally considered unlikely. Therefore, the proposed modification would not cause adverse impacts to transportation and no further analysis is required.

Air Quality

Based on the *2014 CEQR Technical Manual*, a project can cause mobile source impacts, which can arise when an action increases or causes a redistribution of traffic, creates any other mobile sources or pollutants, or adds new uses near existing mobile sources. For this area of New York City, a screening analysis for a mobile source detailed assessment is necessary if the project would generate an increment of 140 auto trips during any peak hour period. A preliminary evaluation was carried out according to the threshold criteria listed above, to determine whether a detailed analysis is warranted. The key criterion applicable to the Proposed Action is whether it would generate 140 or more vehicle trips during any peak hour.

Because the previously analyzed project permitted a 309-space public parking garage to operate on the project site, a detailed garage air quality analysis was conducted. The analysis indicated that the previously analyzed project would not result in any air quality impacts.

As per the *2014 CEQR Technical Manual* projects that would generate peak hour auto traffic or divert existing peak hour traffic 140 or more auto trips in Manhattan between 30th and 61st Streets would require further analyses. The proposed modification would increase the number of parking spaces from 241 to 249, an increase of eight spaces and decrease the reservoir parking spaces from 15 spaces to 12 spaces, a decrease of three reservoir spaces. No new sensitive uses would be created due to the proposed modification. Additionally, the project site is not expected to add a substantial number of local or regional diesel vehicle trips to the surrounding area. Therefore, the proposed modification would not result in significant adverse air quality impacts.

Noise

A noise analysis examines a project for its potential effects on sensitive noise receptors, including effects on the interior noise levels of residential, commercial, and institutional uses. The principal types of noise sources affecting the New York City environment are mobile sources (primarily motor vehicles), stationary sources (typically machinery or mechanical equipment associated with industrial and manufacturing operations or building heating, ventilating, and air conditioning systems) and construction noise (e.g., trucks, bulldozers, power tools, etc.)

As per the *2014 CEQR Technical Manual*, if existing Noise PCE values are increased by 100 percent or more due to a proposed project (which is equivalent to an increase of 3 dB(A) or more), a detailed analysis is generally performed. Conversely, if existing Noise PCE values are not increased by 100 percent or more, it is likely that the proposed project would not cause a significant adverse vehicular noise impact, and therefore, no further vehicular noise analysis is needed.

The proposed modification would increase the number of parking spaces from 241 to 249, an increase of eight spaces and decrease the reservoir parking spaces from 15 spaces to 12 spaces, a decrease of three reservoir spaces. The proposed modification would not generate a Noise PCE increase of 100 percent as compared to existing conditions. Therefore further analysis of mobile noise is not warranted and no significant adverse impact is expected.

Historic Resources

As assessed in the 2011 EAS, activities within 90 feet of a historic or cultural resource requires a preliminary assessment of construction impacts on the possibility of physical damage and vibration to any architectural and archaeological resources. If the project is located within 90 feet, the project is required to comply with DOB Technical Policy and Procedure Notice (TPPN) #10/88 that supplements the standard building protections afforded by Building Code C26-112.4 by requiring a monitoring program to reduce the likelihood of construction damage to adjacent NYC Landmarks and National Register-listed properties to detect the beginnings of damage.

As stated in the 2011 EAS, the project site is located within a 400-foot radius of one building designated as a New York City Landmark (NYCL) and listed on the State/National Registry of Historic Places (S/NRHP). The U.S. General Post Office (now, the James A. Farley Building) encompasses the superblock directly north of the Project Site, bounded by Eighth Avenue, West 31st Street, Ninth Avenue and West 33rd Street. The granite structure was designed as a companion to the original Pennsylvania Station that was located directly east across Eighth Avenue, and was designated as a NYCL in 1966. Also noted in the 2011 EAS, a row of mid-rise 4 to 6 story residential buildings spanning 333-359 West 29th Street (between Eighth and Ninth Avenue) were under consideration for designation as a LPC Historic District, named Lamartine Place Historic District. Neither the U.S. General Post Office nor the potential Lamartine Place Historic District abut the project site, and neither were found to be directly or indirectly affected by the previously analyzed project.

The proposed modification was compared to the possible impacts to architectural resources as per the *2014 CEQR Technical Manual*. There is no physical destruction, demolition, damage, alteration, or neglect of all or part of an historic property as part of the proposed modification. Neither the U.S. General Post Office nor the potential Lamartine Place Historic District abut the project site, therefore visual differences, alterations, or visual relationships in reference to the proposed modification are not relevant. The proposed modification does not include physical expansion of the envelope of the existing garage building or dewatering. Therefore, the proposed modification is not anticipated to result in any significant impacts on archaeological or architectural resources as per the *2014 CEQR Technical Manual*.

Construction Impacts

Although usually temporary, construction impacts can include noticeable and disruptive effects from an action that is associated with construction or could induce construction.



The proposed modification would not involve new development; activity would be limited to reconfiguration of the ground floor to allow modifications to curb cuts and the interior ramp configuration, new ground-level bicycle parking, and streetscape improvements. It is expected that work associated with the proposed modifications would be completed in approximately 3 months with most activity occurring between 7:00 AM and 5:00 PM on weekdays.

The modification activities may result in short-term disruption of both traffic and pedestrian movements at the project site. This would occur primarily due to the potential temporary loss of curbside lanes from the staging of equipment and the movement of materials to and from the site. Additionally, modification activities may at times result in temporary closings of sidewalks adjacent to the site. However, these conditions would not result in significant adverse impacts on traffic and transportation conditions.

Noise associated with the modification activities would be limited to typical construction activities, and would be subject to compliance with the New York City Noise Code and by EPA noise emission standards for construction equipment. These controls and the temporary nature of the modification activity will assure that there would be no significant adverse noise impacts associated with the modification activity.

EXISTING SITE PLANS

W. 31ST STREET ←

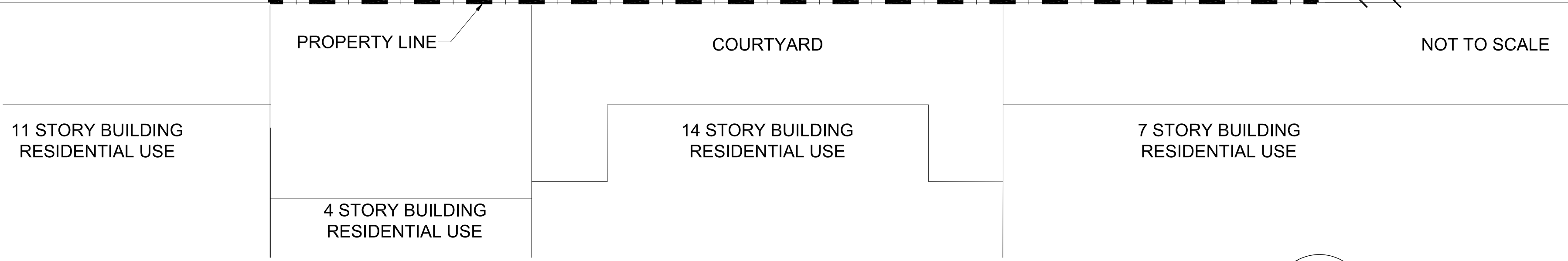
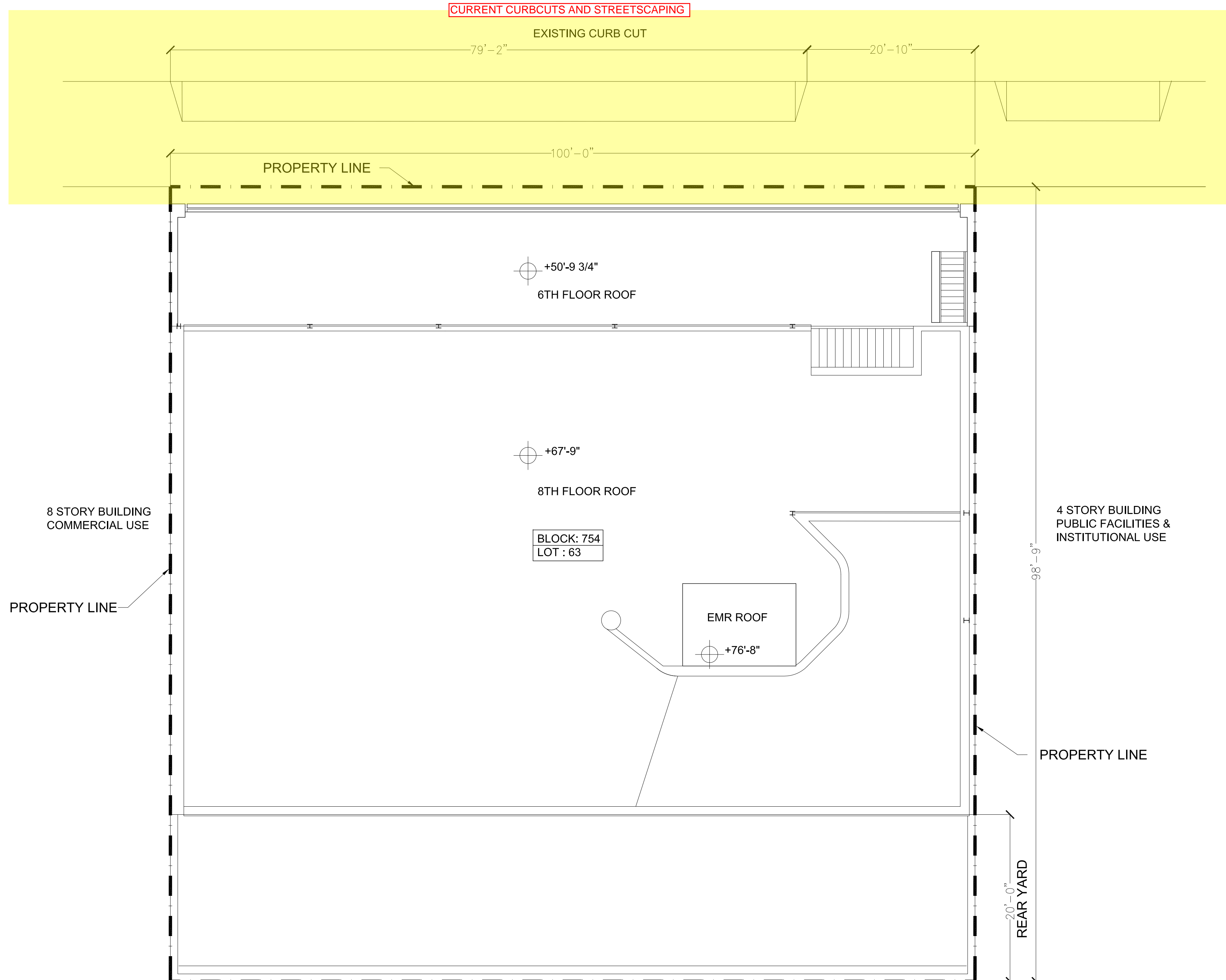

1 SITE PLAN
SCALE: 1/8" = 1'-0"

ZONING DISTRICT : C6-3X
LOT AREA: 9,875 SF

NOTES:
TO THE BEST OF MY KNOWLEDGE, BELIEF AND PROFESSIONAL JUDGMENT, THESE PLANS AND SPECIFICATIONS ARE IN COMPLIANCE WITH THE NEW YORK CITY ENERGY CODE. PROPOSED WORK MEETS THE GUIDELINES AND PRESCRIPTIONS OUTLINED IN THE 2010 NYCECC.

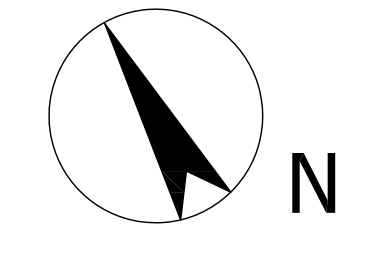

→ VEHICLE FLOW

Job Name:
340 West 31st Street

340 West 31st Street
New York, NY 10001

Architects:
WQB Architecture PLLC
345 SEVENTH AVENUE, 17th FLOOR
NEW YORK, NY 10001
Tel 212 279 0550
Fax 212 279 4015

Revisions	Date	Remarks
Project		

340 WEST 31ST STREET
New York, NY 10001

EXISTING SITE PLAN

Seal & Signature
Date: 01/07/2014
Project No.: 2013.48
Drawn by: WX
Checked by: WQB
Drawing No.

A-001.00

W. 31ST STREET

SECTION A

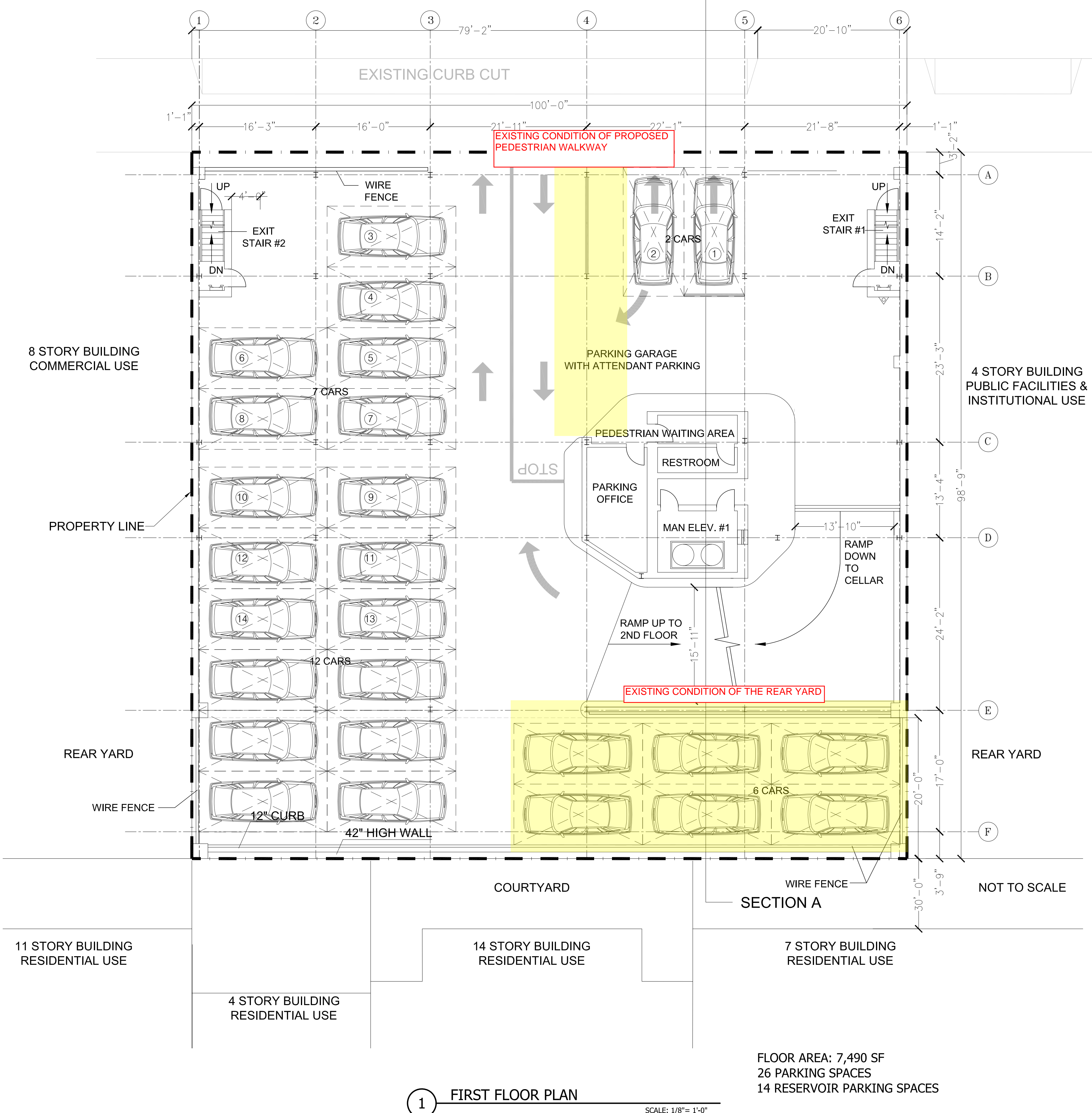

ZONING DISTRICT C6-3X, BLOCK 754, LOT 63							
GARAGE AREA & CAPACITY							
	SUBCELLAR	CELLAR	GROUND FLOOR	2ND - 7TH FLOORS	8TH FLOOR	ROOF	TOTAL
PARKING AREA (SF)	9,875	9,300	7,490	7,690x6=46,140	6,070	6,070	59,700
NUMBER OF SPACES							241
NUMBER OF RESERVIOR SPACES							14
TOTAL NUMBER OF SPACES							255

THE GARAGE IS AN OPEN (NOT ENCLOSED) GARAGE.

LEGEND

- RESERVIOR SPACE 8' X 18'-6"
- PARKING SPACE 8' X 18'-6"
- CURB CUT
- AREA NOT PART OF GARAGE & NOT SUBJECT TO SPECIAL PERMIT
- PEDESTRIAN WALK ZONE
- ZONING LOT BOUNDARY
- 2 HOUR OF FIRE RATED WALL
- BICYCLE PARKING ZONE
- BOLLARD
- DIRECTIONAL AND WALL MOUNTED EXIT SIGN
- EMERGENCY LIGHT
- FLOOR DRAIN
- TRAFFIC LIGHT
- FIRE EXTINGUISHER
- RESERVED PARKING

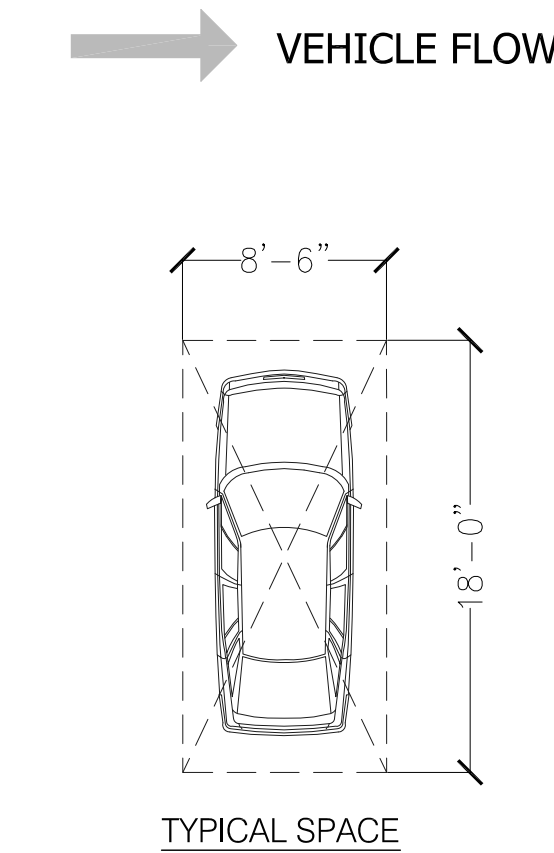

1 FIRST FLOOR PLAN

SCALE: 1/8" = 1'-0"

FLOOR AREA: 7,490 SF
26 PARKING SPACES
14 RESERVIOR PARKING SPACES

Revisions	Date	Remarks
Project		

340 WEST 31ST STREET
New York, NY 10001

EXISTING
GROUND FLOOR PLAN



Seal & Signature	Date: 01/07/2014
	Project No.: 2013.48
	Drawn by: WX
	Checked by: WQB
	Drawing No.

A-003.00

Project Information

-  600' Buffer
-  Development Site







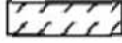
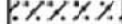

Existing District

-  Existing Zoning District
-  Existing Special District

Existing Commercial Overlays

-  C 1-5
-  C 2-5

Property Lines

-  Property Lines
-  Number of Floors
-  Street Width
-  Block Number
-  Commuter Rail
-  Subway Lines A, C, E
-  Subway Entries
-  Traffic Direction

Land Use

-  01 - One & Two Family Buildings
-  02 - MultiFamily Walkup Buildings
-  03 - MultiFamily Elevator Buildings
-  04 - Mixed Commercial/Residential Buildings
-  05 - Commercial/Office Buildings
-  06 - Industrial/Manufacturing
-  07 - Transportation/Utility
-  08 - Public Facilities & Institutions
-  09 - Open Space
-  10 - Parking Facilities
-  11 - Vacant Land

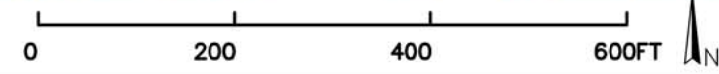
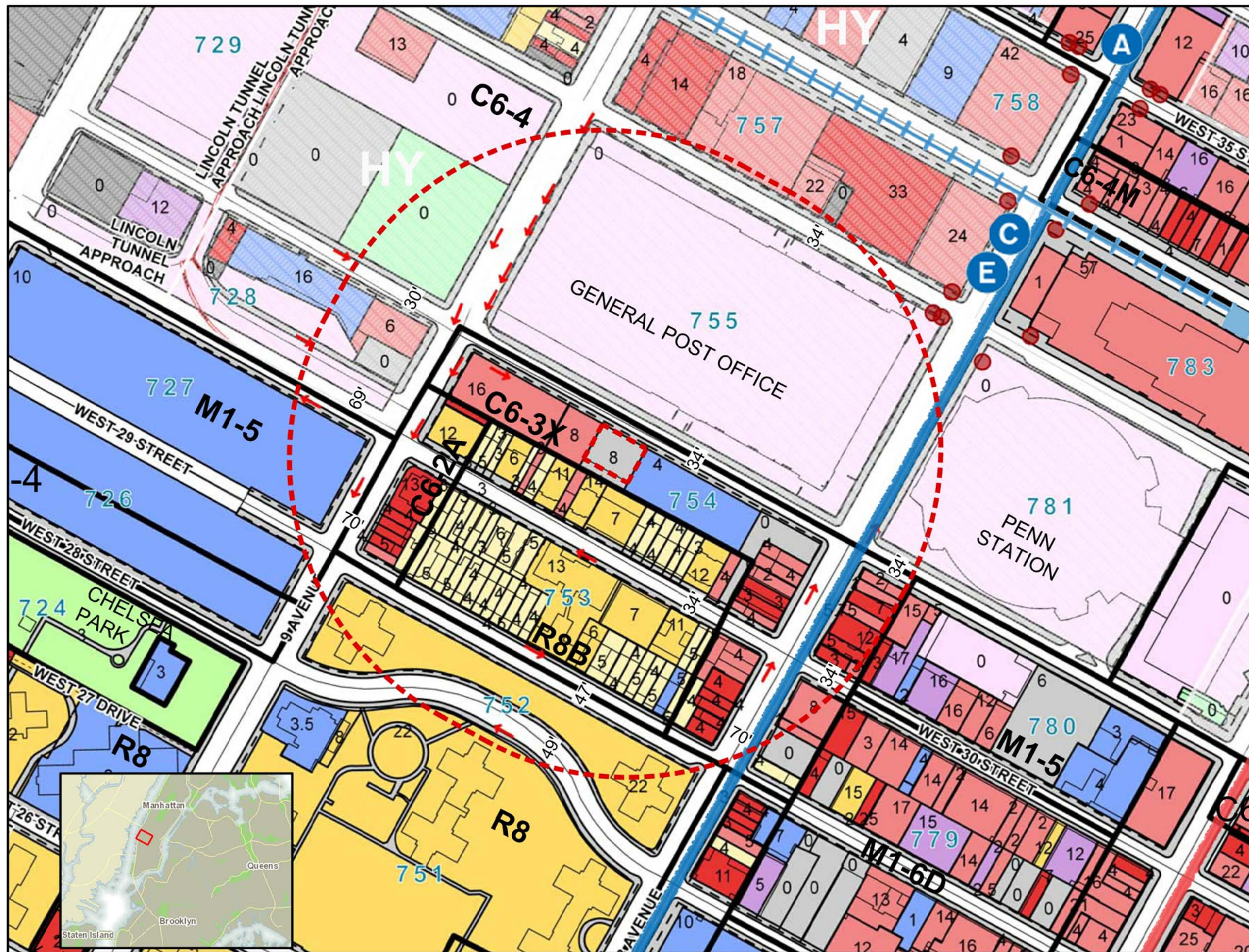

**PREVIOUSLY APPROVED
SPECIAL PERMIT DRAWINGS**

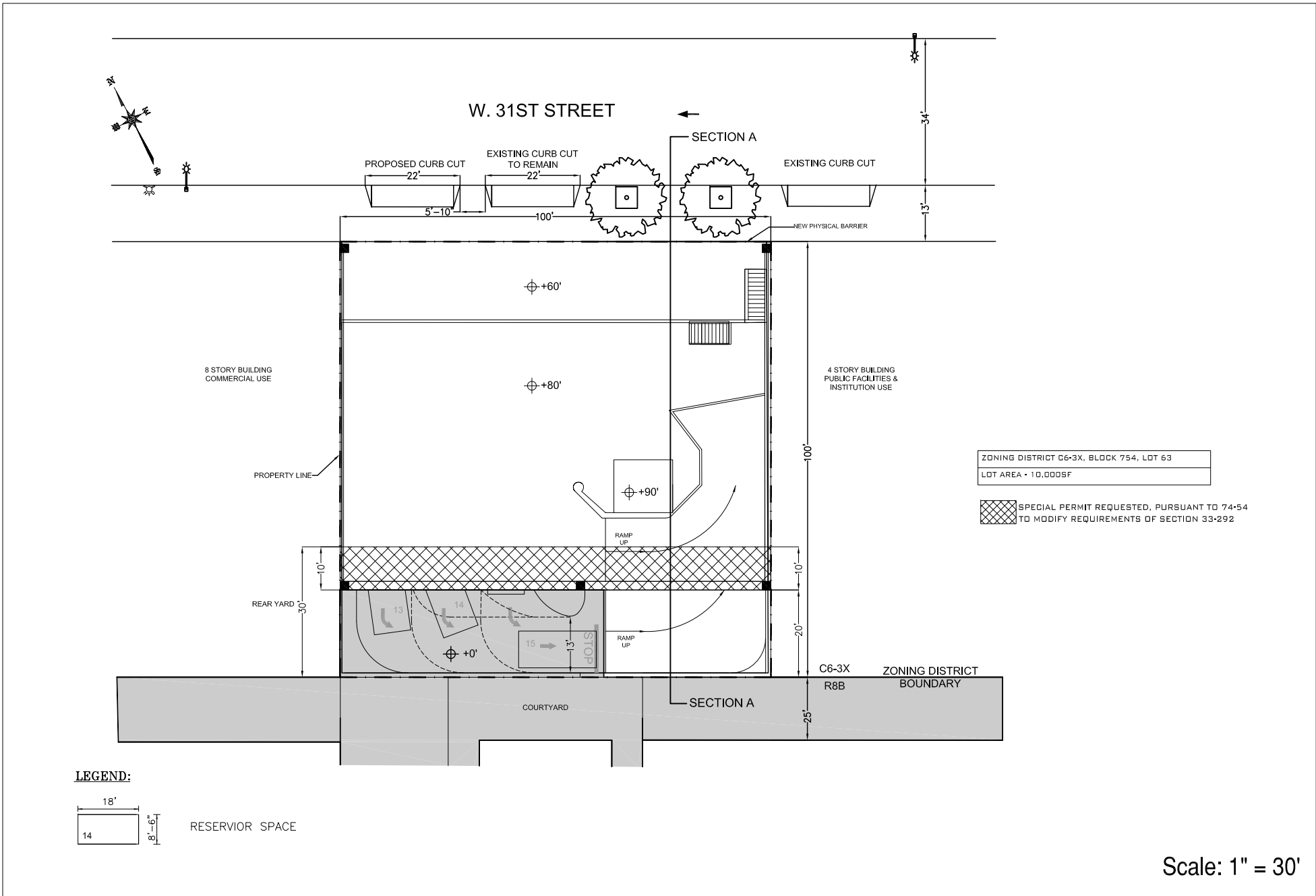

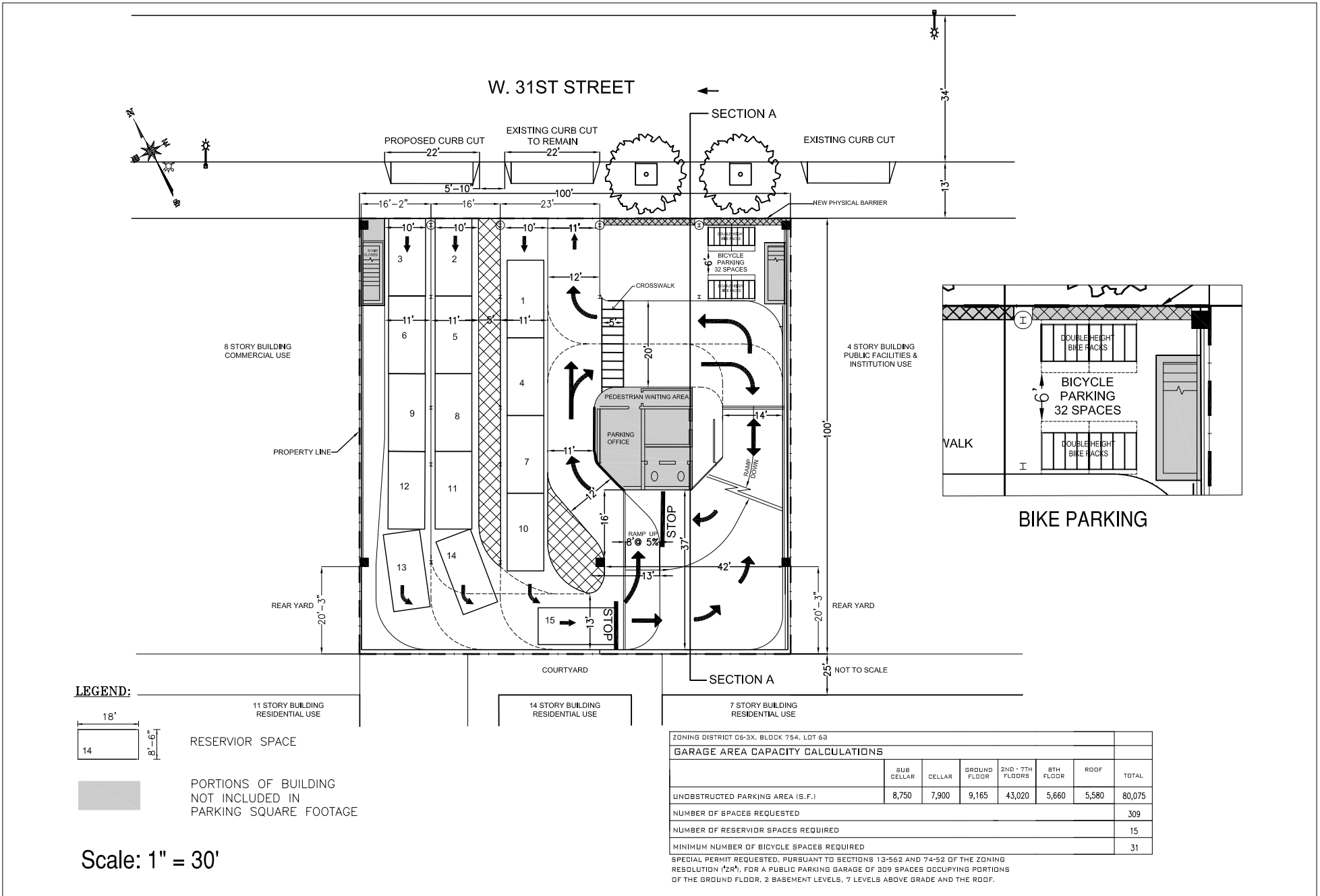

Post Office Garage EAS

Figure A-4b
Proposed Garage Plan - Ground Level

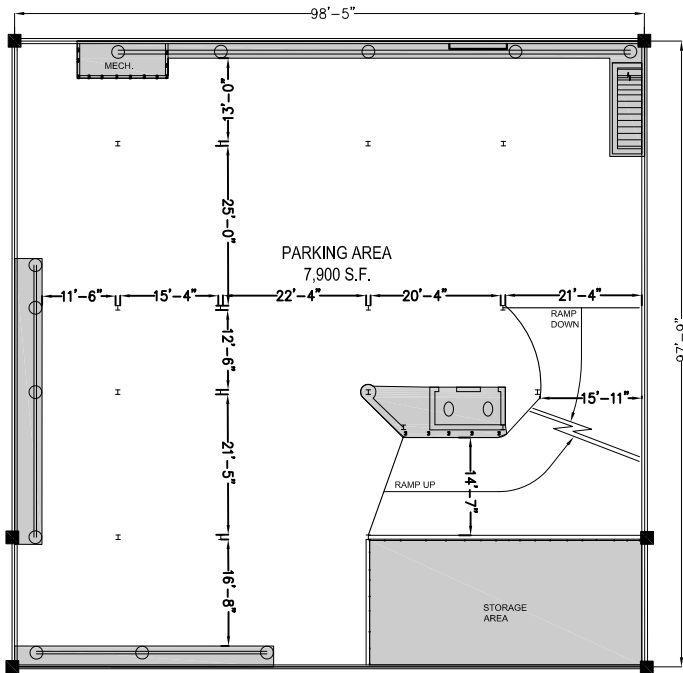

CELLAR LEVEL

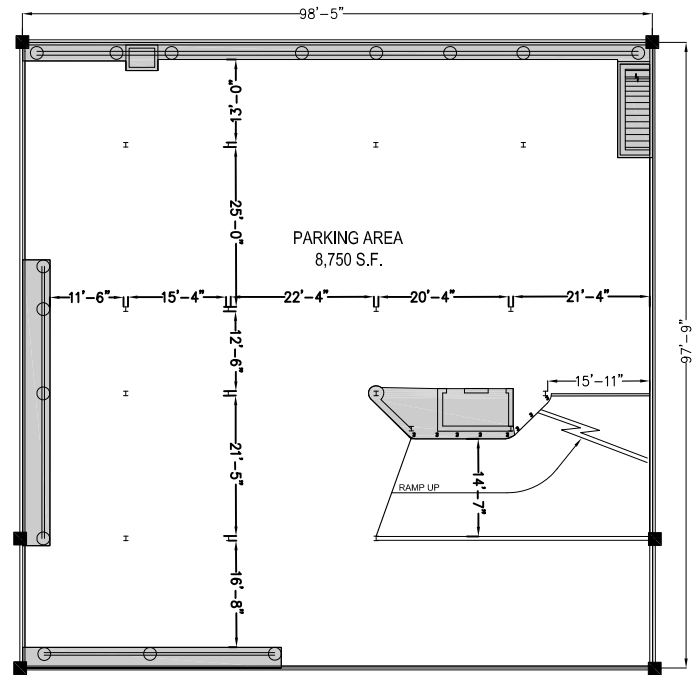

SUB CELLAR LEVEL

LEGEND:



PORTIONS OF BUILDING
NOT INCLUDED IN
PARKING SQUARE FOOTAGE

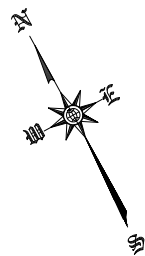

Scale: 1" = 30'

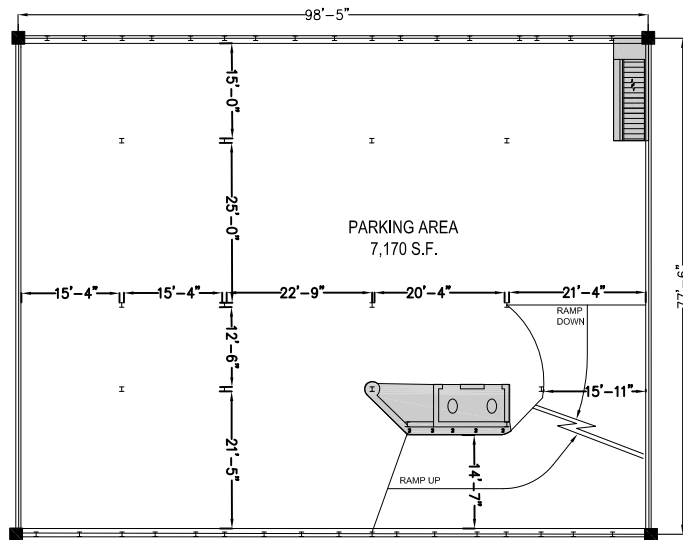

FLOORS TWO THROUGH SEVEN

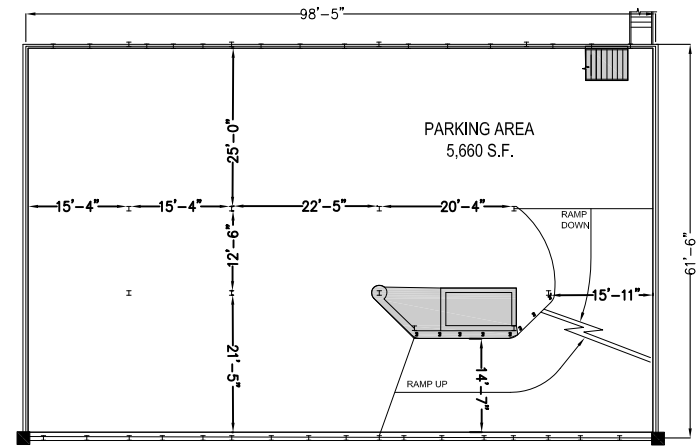

8TH FLOOR

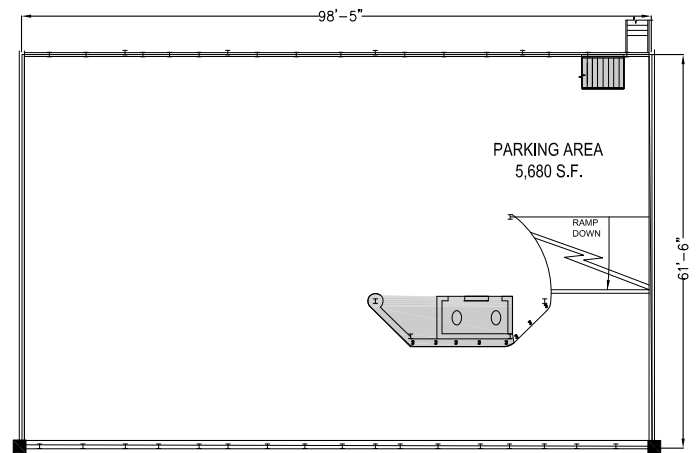

ROOF

Scale: 1" = 30'

LEGEND:



PORTIONS OF BUILDING
NOT INCLUDED IN
PARKING SQUARE FOOTAGE

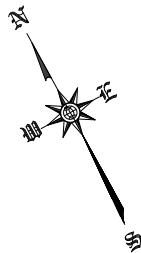

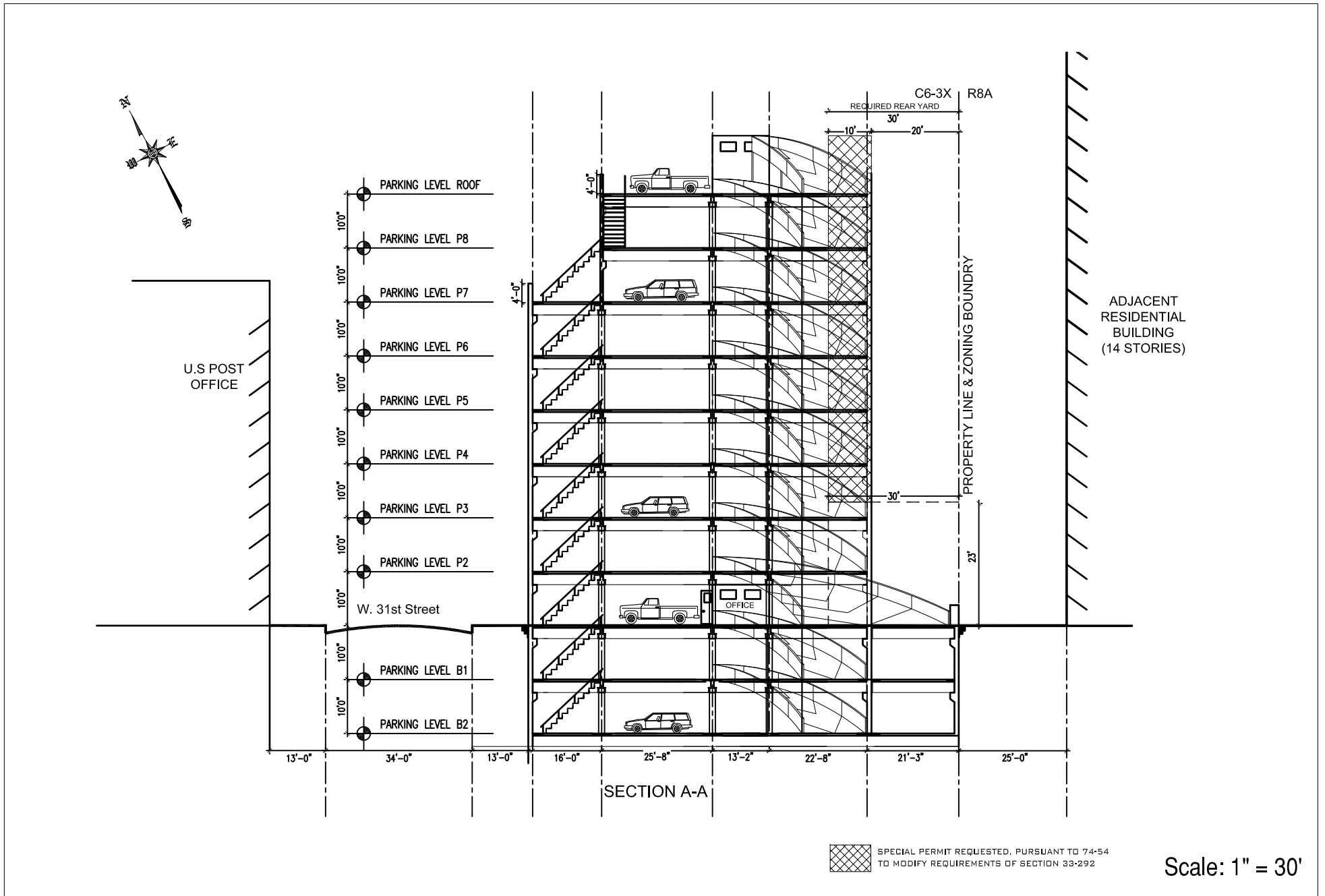

Post Office Garage EAS

Figure A-4e

Proposed Garage - Proposed Section and Rear Yard Encroachment

PROPOSED MODIFICATION DRAWINGS

Job Name:
340 West 31st Street

340 West 31st Street
New York, NY 10001

Architects:
WQB Architecture PLLC
545 West 45th Street, 4th Floor
New York, New York 10036
Tel 212 995 5600
Fax 917 517 2330

Owner:
Post Office Garage, LLC
c/o Meyers Parking
441 Lexington Avenue
New York, NY 10017

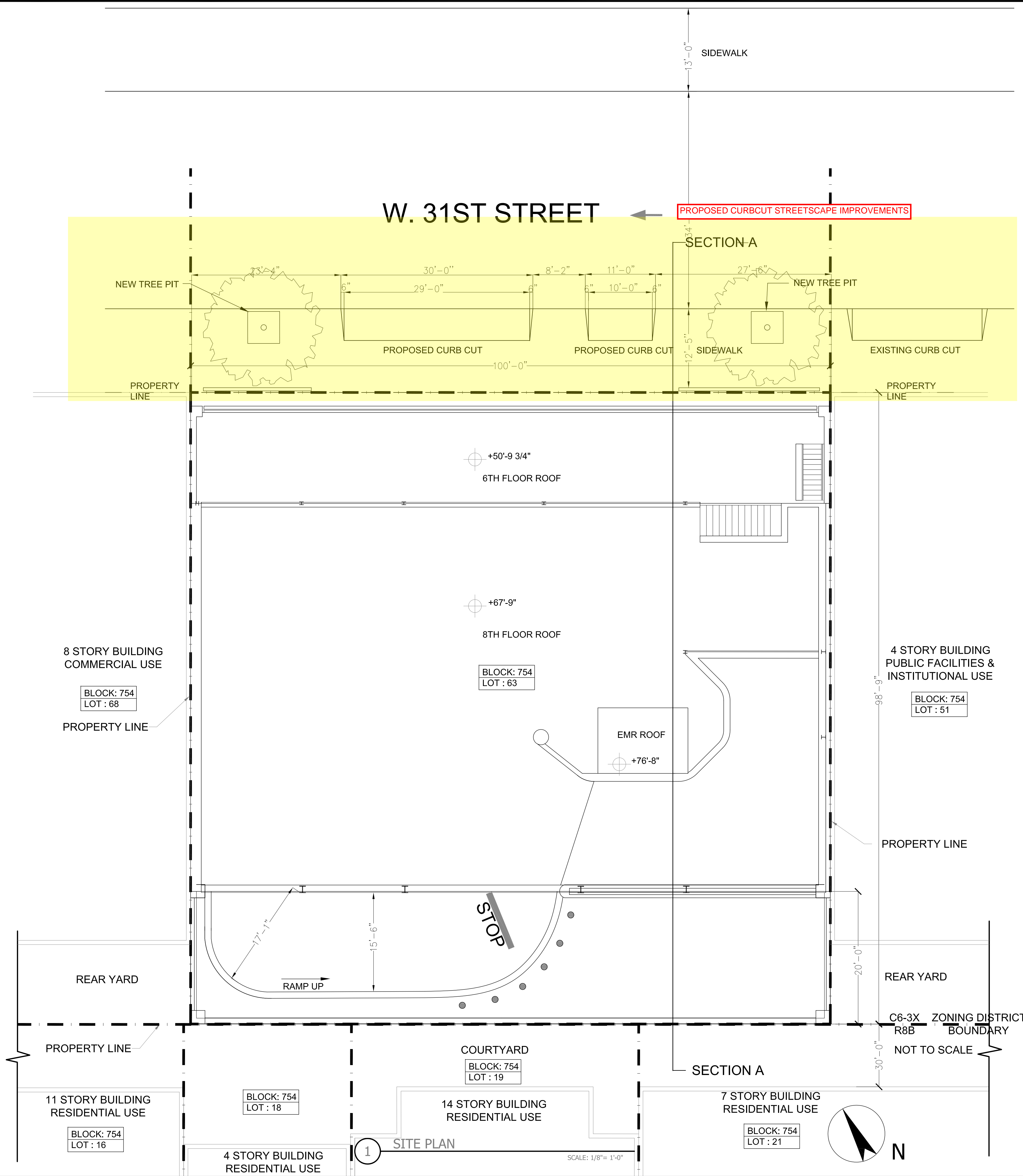

ZONING DISTRICT : C6-3X
BLOCK 754, LOT 63
LOT AREA: 9,875 SF

NOTES:
TO THE BEST OF MY KNOWLEDGE, BELIEF AND PROFESSIONAL JUDGMENT, THESE PLANS AND SPECIFICATIONS ARE IN COMPLIANCE WITH THE NEW YORK CITY ENERGY CODE. PROPOSED WORK MEETS THE GUIDELINES AND PRESCRIPTIONS OUTLINED IN THE 2010 NYCECC.

THE GARAGE IS AN OPEN (NOT ENCLOSED) GARAGE.

- LEGEND
- RESERVOIR SPACE 8'-6" X 18'-0"
 - PARKING SPACE 8'-6" X 18'-0"
 - CURB CUT
 - AREA NOT PART OF GARAGE & NOT SUBJECT TO SPECIAL PERMIT
 - PEDESTRIAN WALK ZONE
 - ZONING LOT BOUNDARY
 - 2 HOUR OF FIRE RATED WALL
 - BICYCLE PARKING ZONE
 - BOLLARD
 - SPEED BUMP
 - DIRECTIONAL AND MOUNTED EXIT SIGN
 - EMERGENCY LIGHT
 - FLOOR DRAIN
 - TRAFFIC LIGHT
 - FIRE EXTINGUISHER
 - RESERVOIR PARKING

Revisions	Date	Revised drawing	Remarks
1	10/08/2015		

340 WEST 31ST STREET
New York, NY 10001

SITE PLAN

Seal & Signature _____
Date: 10/01/2015
Project No: 2013-48
Drawn by: YMS, WX
Checked by: WQB
Drawing No.
A-002.00

W. 31ST STREET

SECTION A

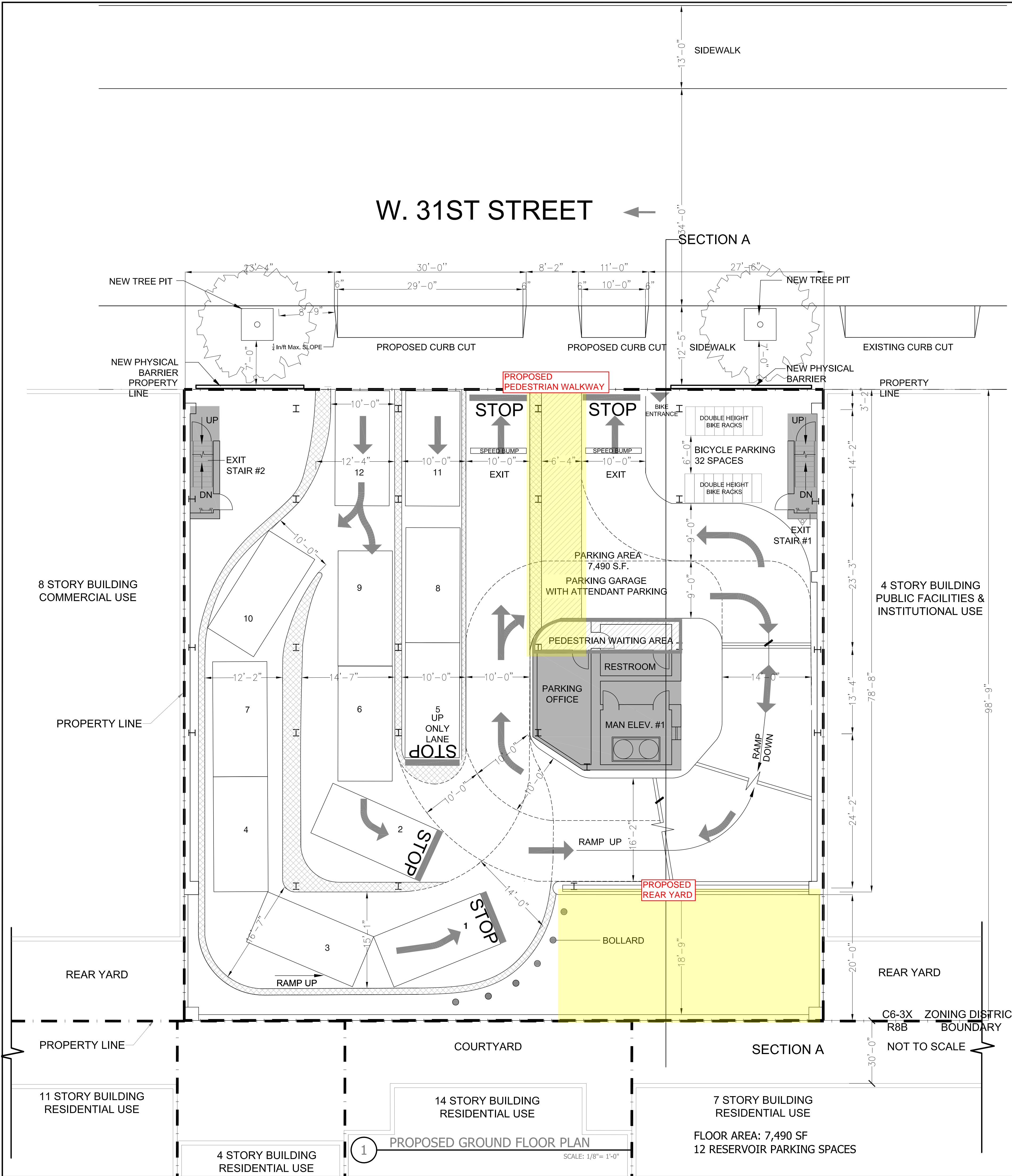

RESERVOIR SPACES:

PER MANHATTAN CORE PARKING (N130105 ZRM, ENACTED 5/8/2013), 13-25 RESERVOIR SPACE REQUIREMENT FOR PUBLIC PARKING GARAGE: 5% OF ALL SPACES FOR A FACILITY WITH OVER 200 SPACES

TOTAL REQUIRED: 5% x 249 = 12.45 = 12 SPACES

STORY	NO. OF RESERVOIR SPACES
1ST FLOOR	12
TOTAL:	12

ZONING DISTRICT C6-3X, BLOCK 754, LOT 63

GARAGE AREA & CAPACITY							
	SUBCELLAR	CELLAR	GROUND FLOOR	2ND - 7TH FLOORS	8TH FLOOR	ROOF	TOTAL
PARKING AREA (SF)	9,875	9,300	7,490	7,690x6=46,140	6,070	6,070	59,700
NUMBER OF PROPOSED PARKING SPACES							249
NUMBER OF RESERVOIR PARKING SPACES							12
MINIMUM NUMBER OF BIKE SPACE							ZR 36 - 711

BICYCLE PARKING SPACES:

PER BICYCLE PARKING ZONING TEXT AMENDMENT 36-711, BICYCLE PARKING REQUIREMENT FOR PUBLIC PARKING GARAGE: 1 BICYCLE PARKING SPACE PER 10 VEHICLE SPACES

TOTAL REQUIRED: 249 / 10 = 24.9 = 25
EXISTING BICYCLE PARKING SPACES : 32> 25 SPACES, COMPLIES.

THE GARAGE IS AN OPEN (NOT ENCLOSED) GARAGE.

LEGEND

- RESERVOIR SPACE 8'-6" X 18'-0"
- PARKING SPACE 8'-6" X 18'-0"
- CURB CUT
- AREA NOT PART OF GARAGE & NOT SUBJECT TO SPECIAL PERMIT
- PEDESTRIAN WALK ZONE
- ZONING LOT BOUNDARY
- 2 HOUR OF FIRE RATED WALL
- BICYCLE PARKING ZONE
- BOLLARD
- SPEED BUMP
- DIRECTIONAL AND WALL MOUNTED EXIT SIGN
- EMERGENCY LIGHT
- FLOOR DRAIN
- TRAFFIC LIGHT
- FIRE EXTINGUISHER
- RESERVOIR PARKING
- OFFICE, MECHANICAL, ELECTRICAL, OTHER SPACE NOT INCLUDED IN CALCULATIONS

→ VEHICLE FLOW

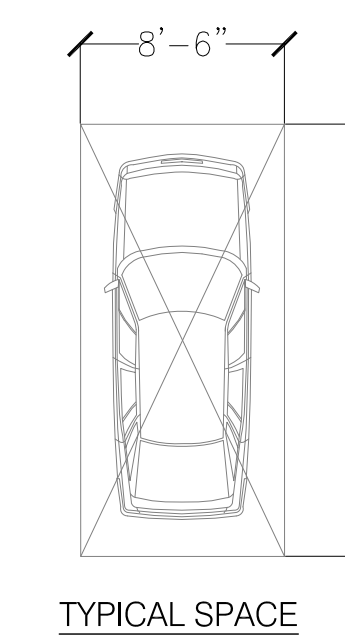

Revisions	Date	Remarks
3	09/09/2015	Revised drawing
2	08/06/2015	Revised drawing
1	07/29/2015	Revised drawing

340 WEST 31ST STREET
New York, NY 10001

**PROPOSED
GROUND FLOOR PLAN**

Seal & Signature

Date: 01/07/2014
Project No.: 2013.48
Drawn by: YS
Checked by: WQB
Drawing No.

A-004.00