

GEORGE'S OUTDOOR CAFE



SITE PLAN



LEGEND

- ① Kaufman Astoria Studios
- ② Museum of the Moving Image
- ③ Warehouse Building
- ④ Commercial Building with Street Level Retail Spaces
- ⑤ UA Kaufman Astoria Theater
- ⑥ Charter School
- ⑦ Industrial/Manufacturing
- ⑧ Frank Sinatra School of the Arts
- ⑨ Commercial Office Building
- ⑩ Public School
- ⑪ Mixed-Use Residential/Commercial
- ⑫ General Residential Area

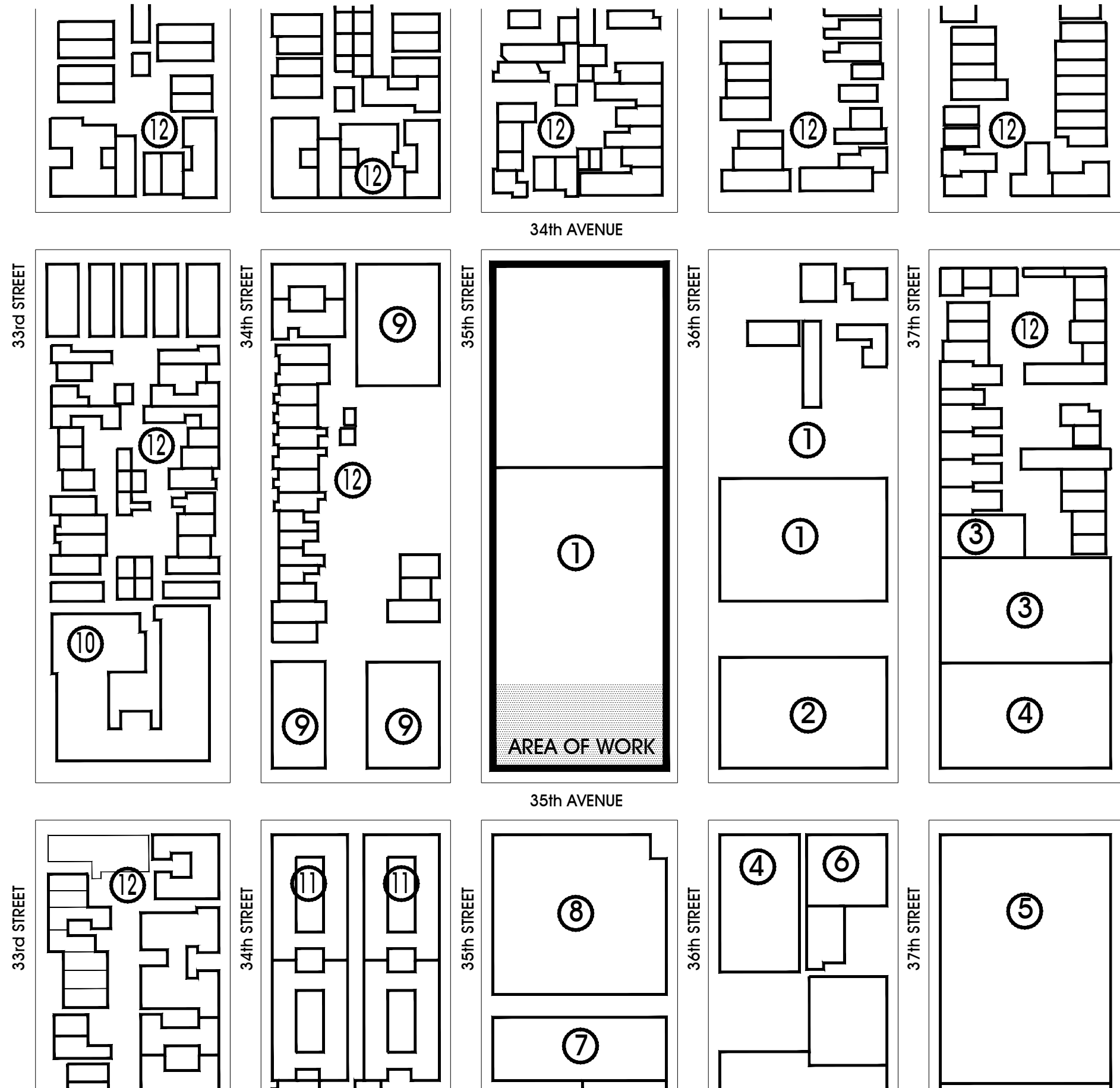



Designation Photo - 1



Designation Photo - 2

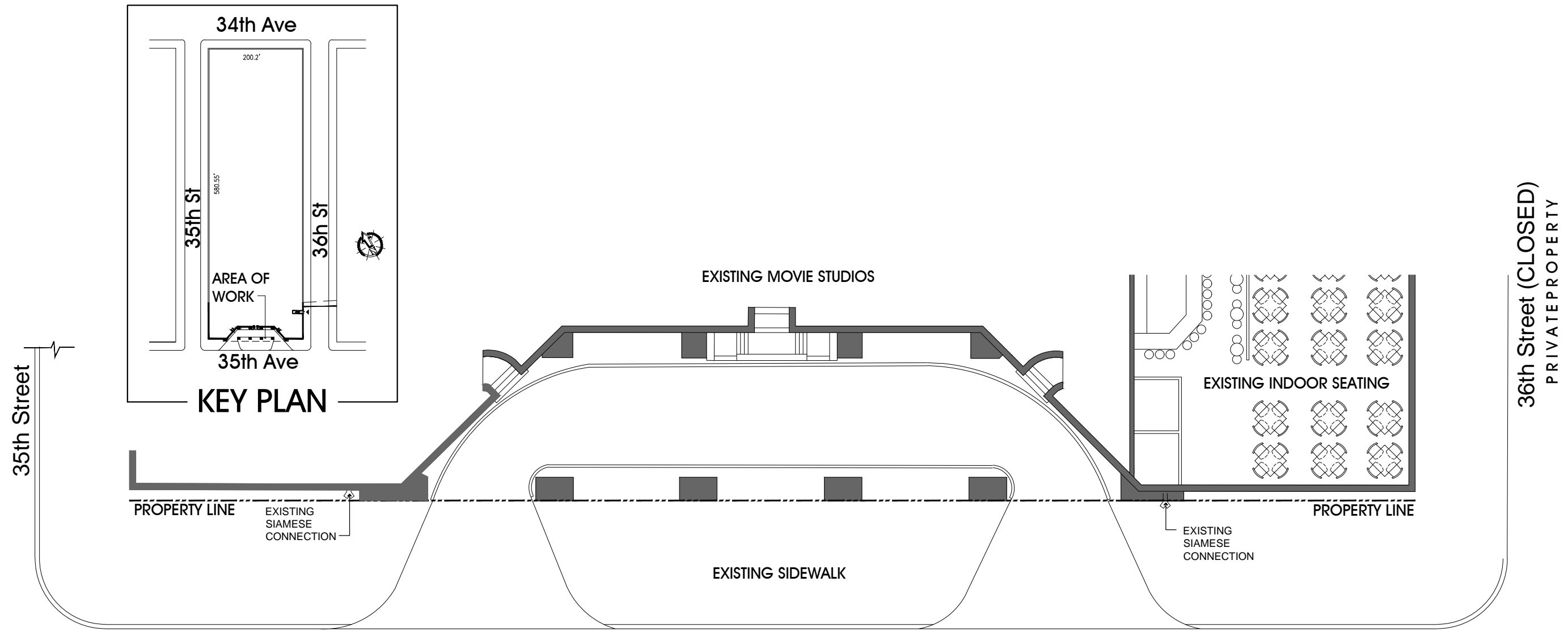

35th Avenue
PORTE COCHERE EXISTING PLAN VIEW

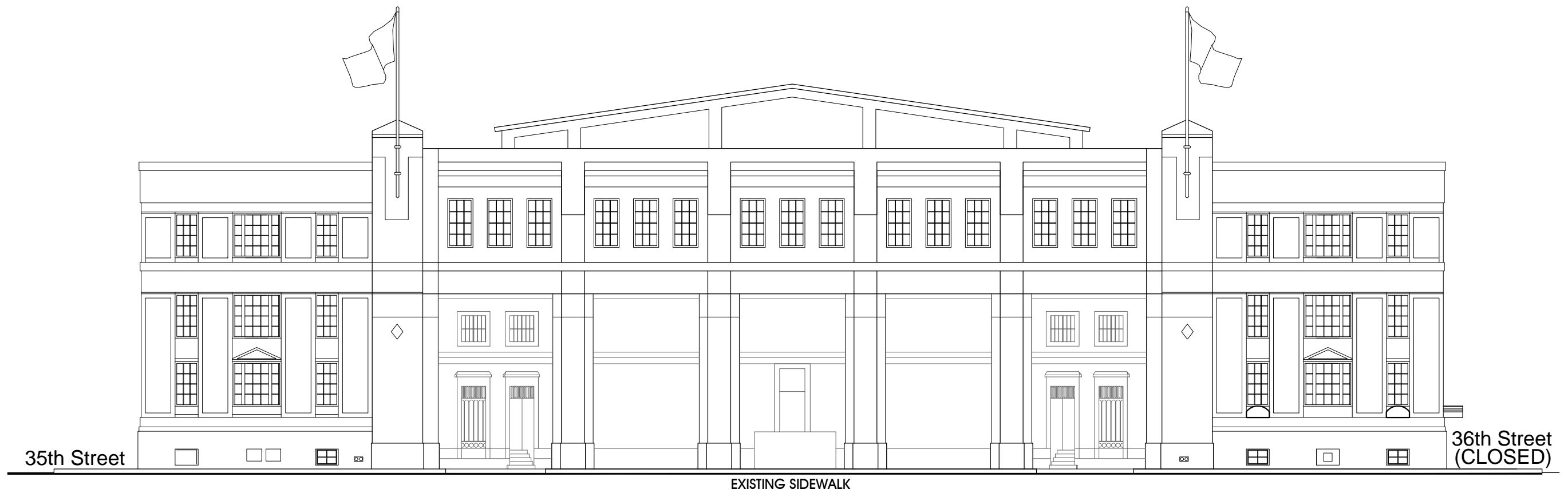

35th Avenue EXTERIOR ELEVATION - EXISTING

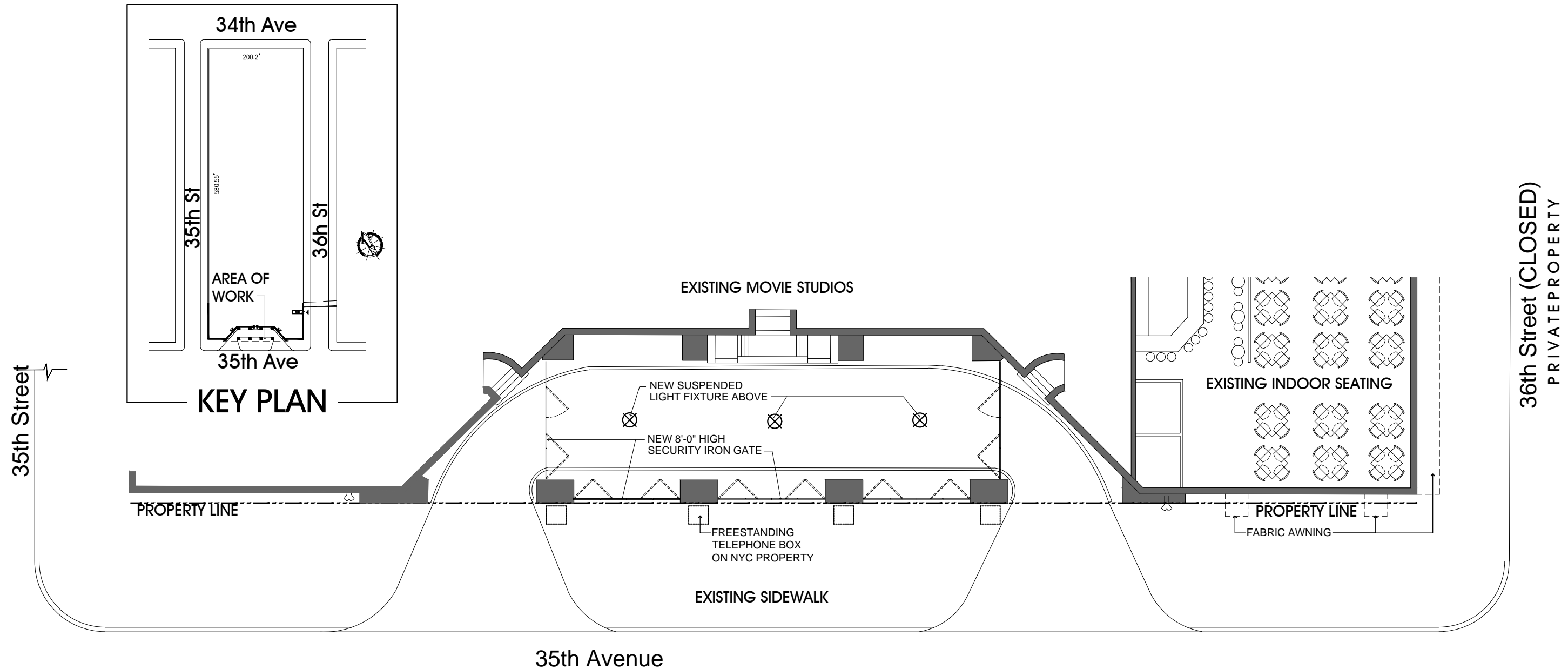

PORTE COCHERE PROPOSED FENCE, LIGHTING AND AWNINGS PLAN VIEW

LEGEND:

- ① NEW ACCENT WALL WASHER UPLIGHT
- ② NEW ACCENT WALL WASHER DOWNLIGHT
- ③ NEW SUSPENDED LIGHT FIXTURE
- ④ FREESTANDING TELEPHONE BOX ON NYC PROPERTY
- ⑤ NEW 8ft HIGH SECURITY IRON GATE
- ⑥ NEW CANVAS AWNING

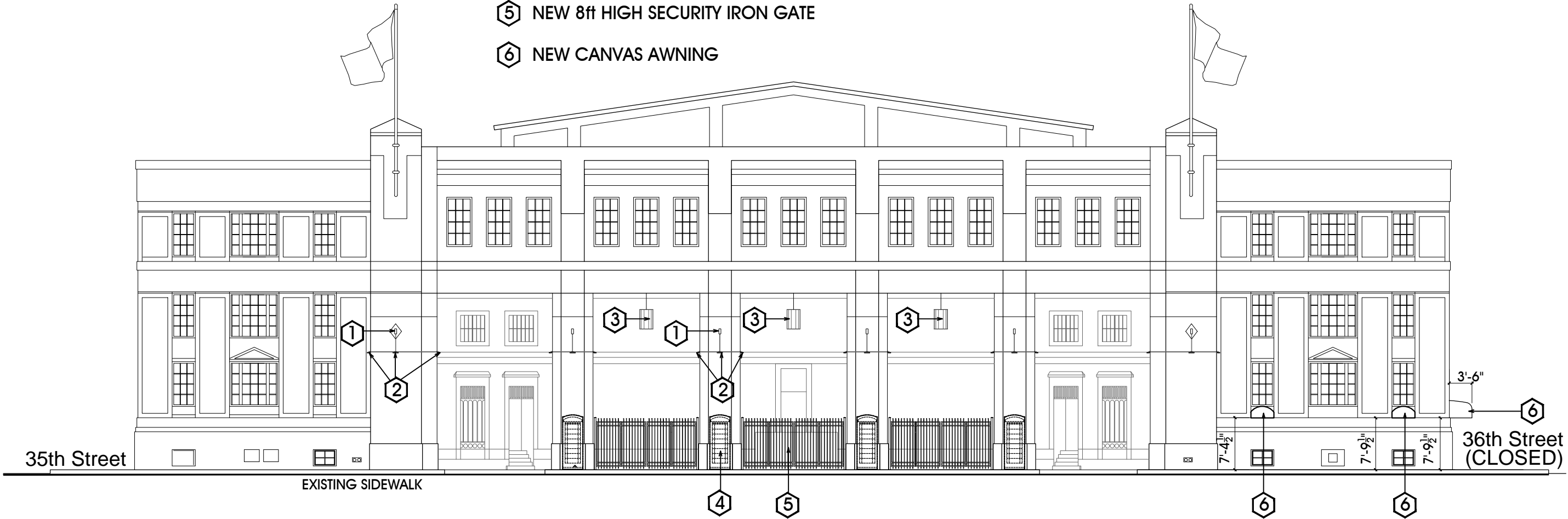

35th Avenue EXTERIOR ELEVATION - PROPOSED FENCE, LIGHTING & AWNINGS

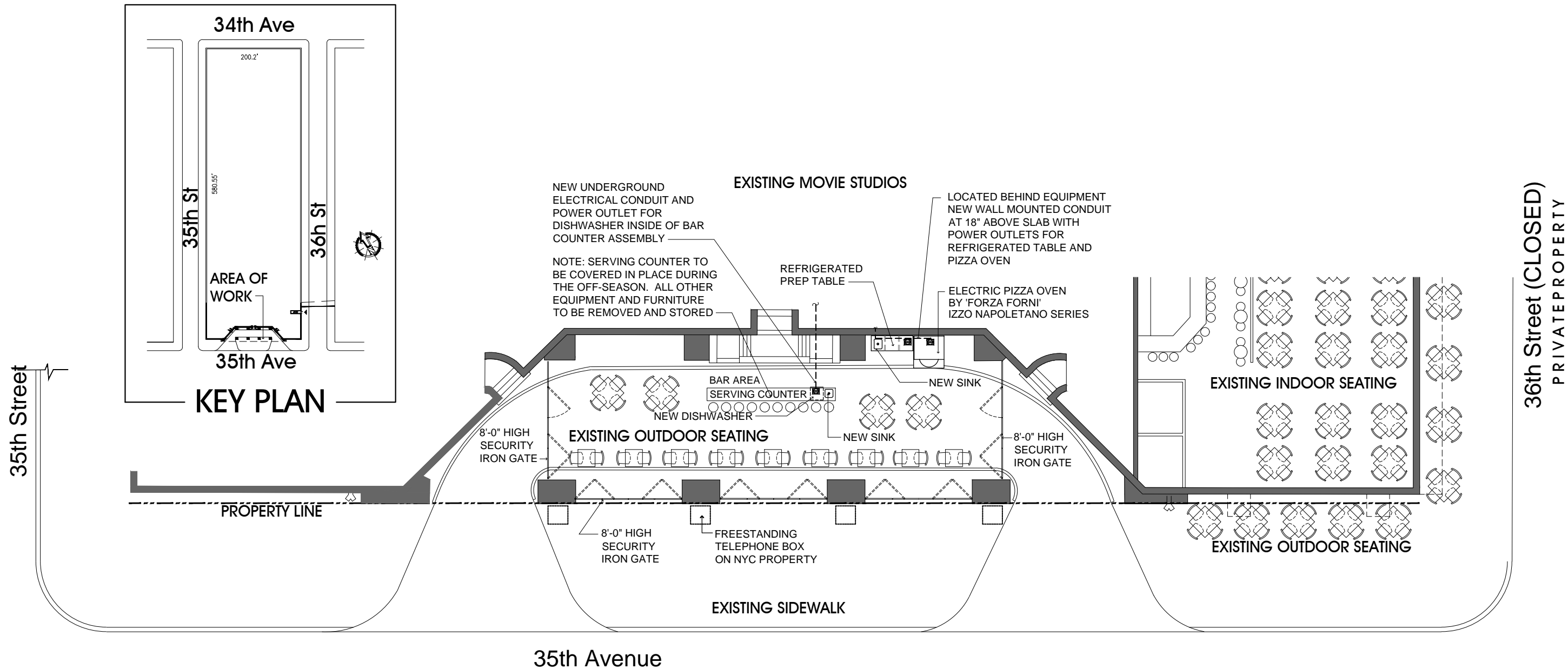

PORTE COCHERE PROPOSED GEORGE'S OUTDOOR CAFE

LEGEND:

- ① NEW ACCENT WALL WASHER UPLIGHT
- ② NEW ACCENT WALL WASHER DOWNLIGHT
- ③ NEW SUSPENDED LIGHT FIXTURE
- ④ FREESTANDING TELEPHONE BOX ON NYC PROPERTY
- ⑤ NEW 8ft HIGH SECURITY IRON GATE
- ⑥ NEW CANVAS AWNING

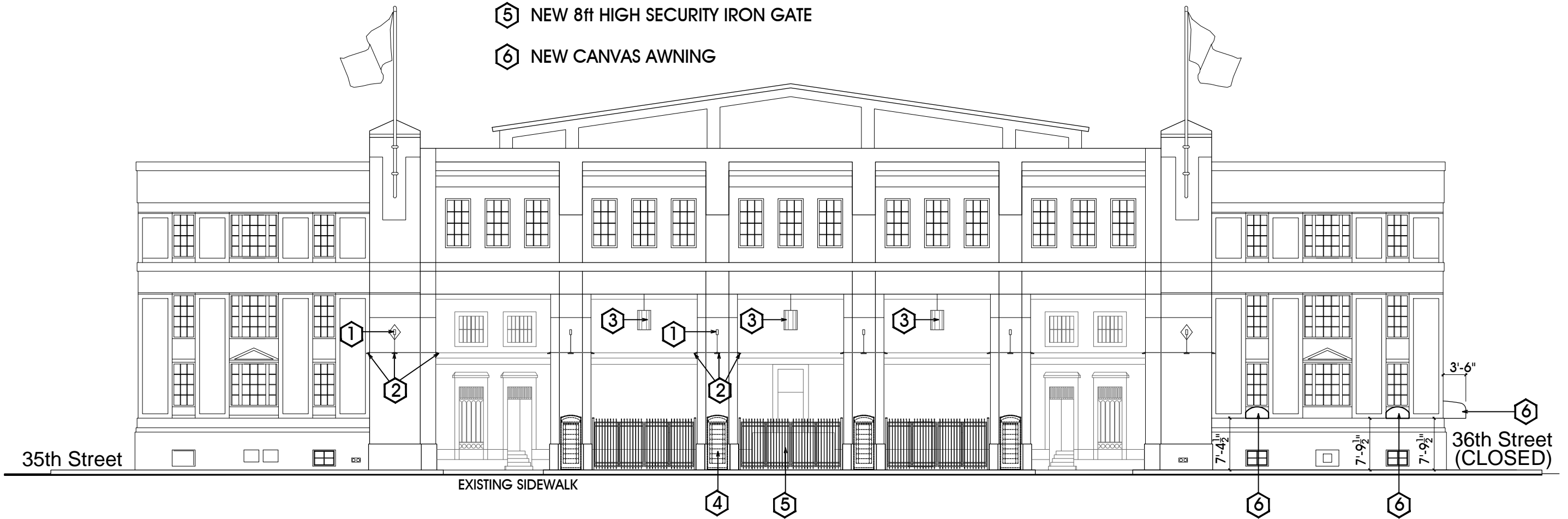

35th Avenue EXTERIOR ELEVATION - GEORGE'S OUTDOOR CAFE

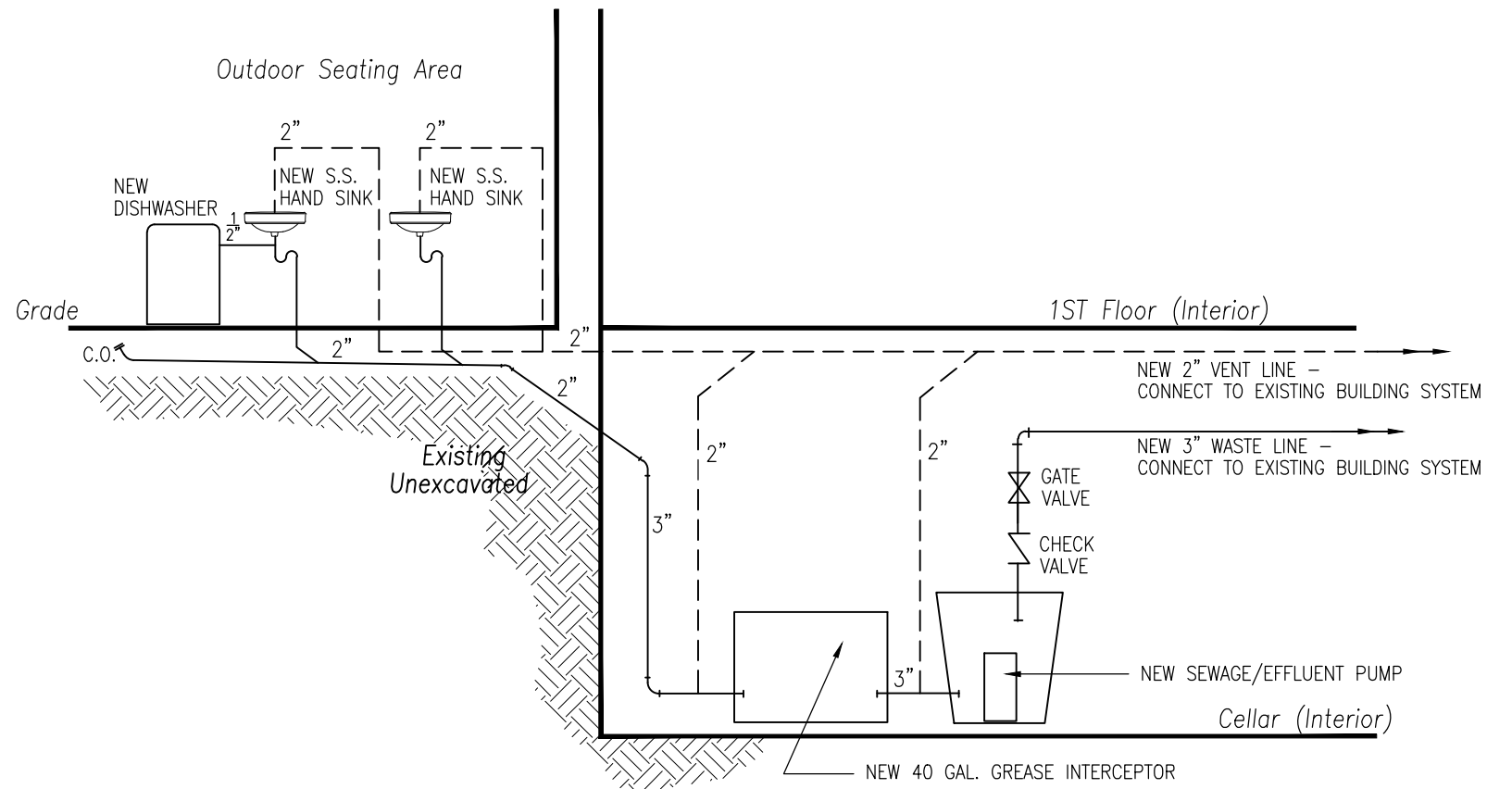
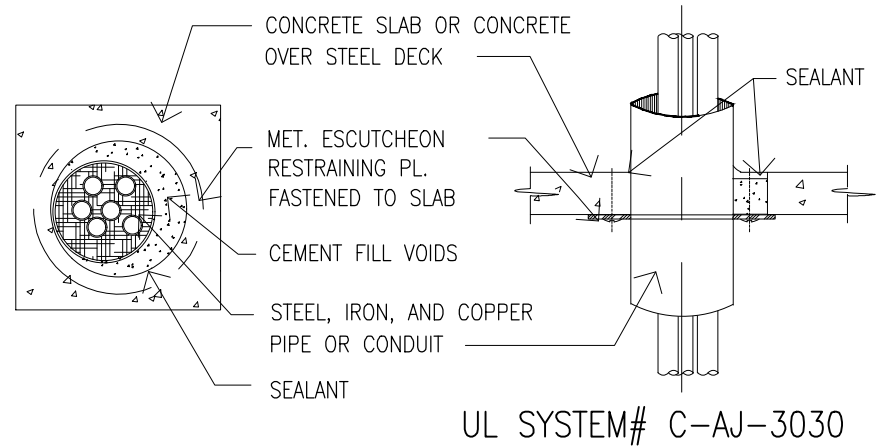
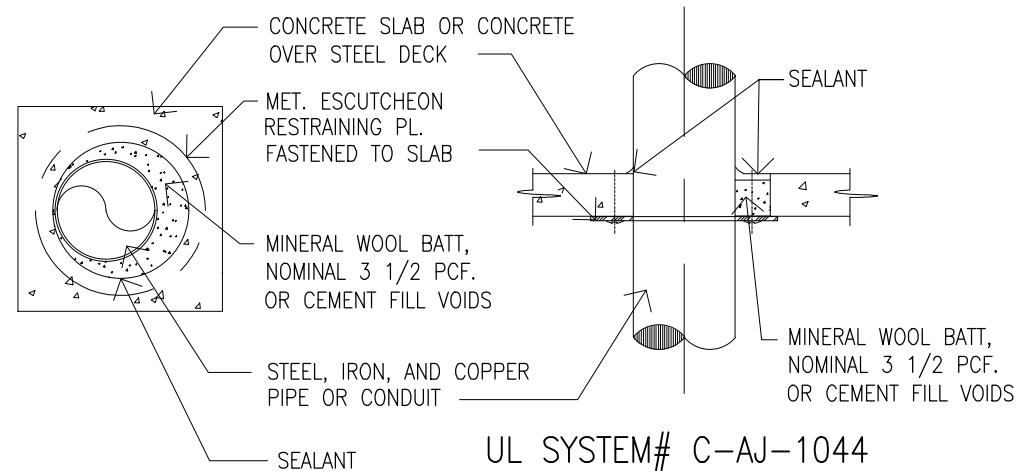
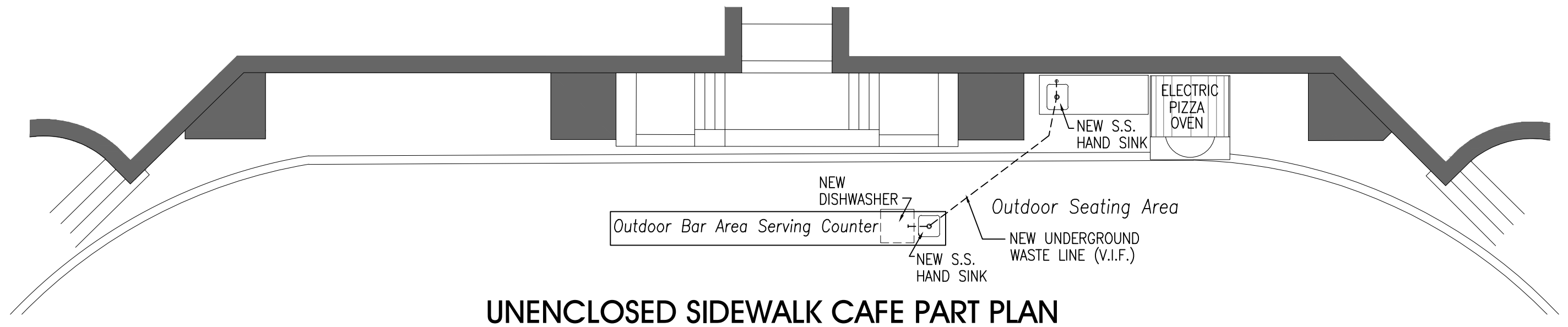

TYPICAL FIRESTOPPING DETAILS

SANITARY RISER DIAGRAM



View from the corner of
35th Street & 35th Avenue

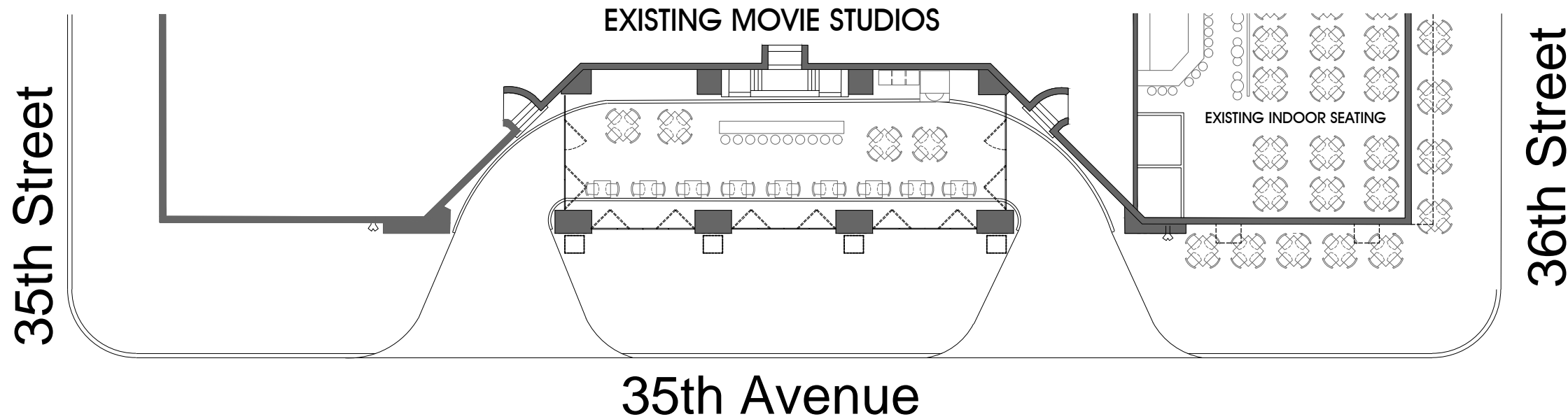
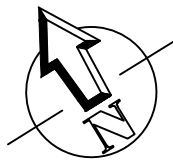



Partial View from
35th Avenue

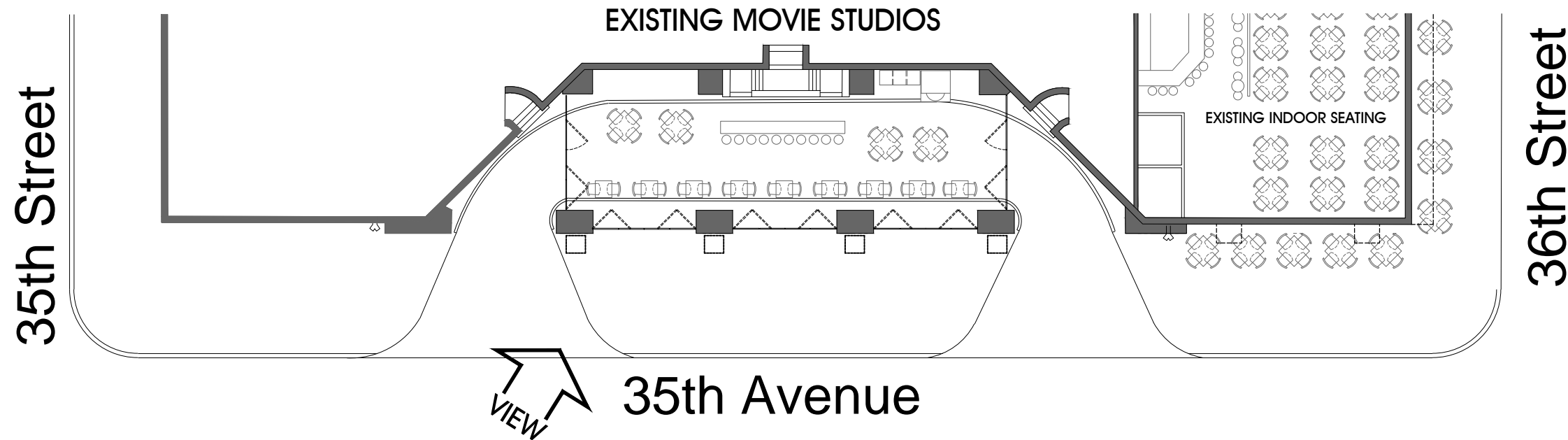
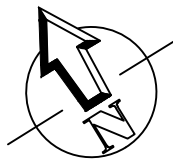



View from the corner of
36th Street & 35th Avenue

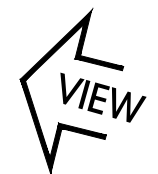
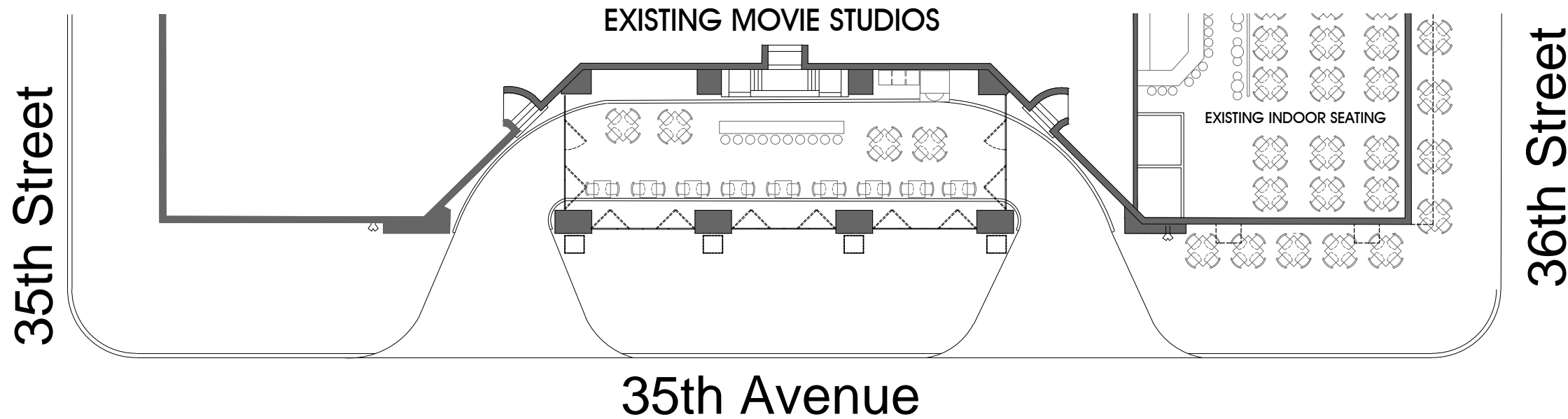
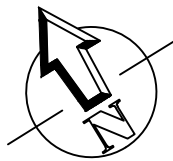

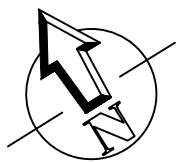

View of awnings
from the corner of
36th Street & 35th Avenue

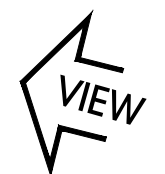
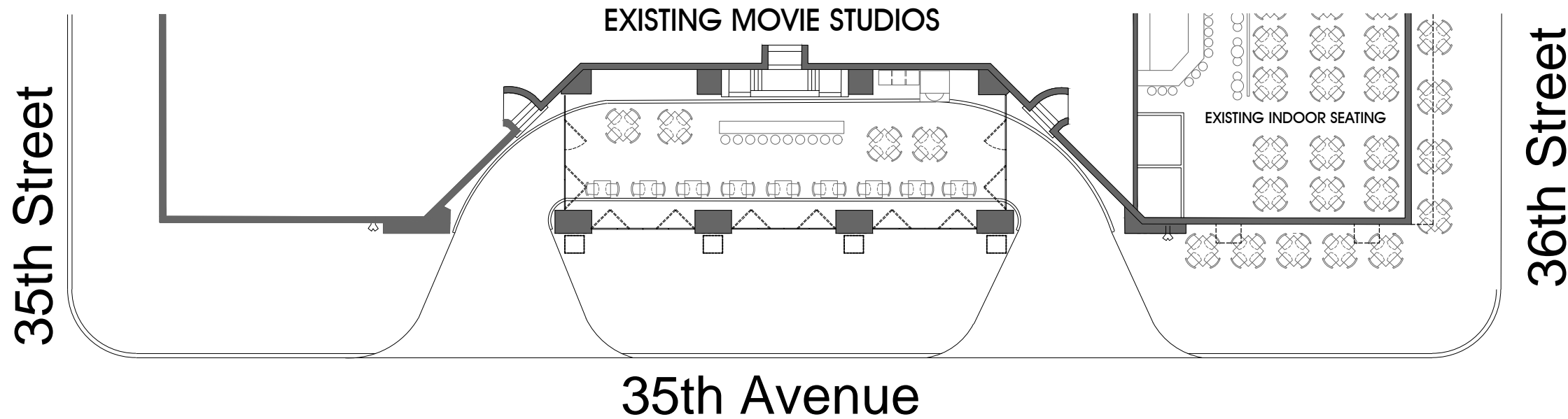



View of awning from the corner of 36th Street & 35th Avenue

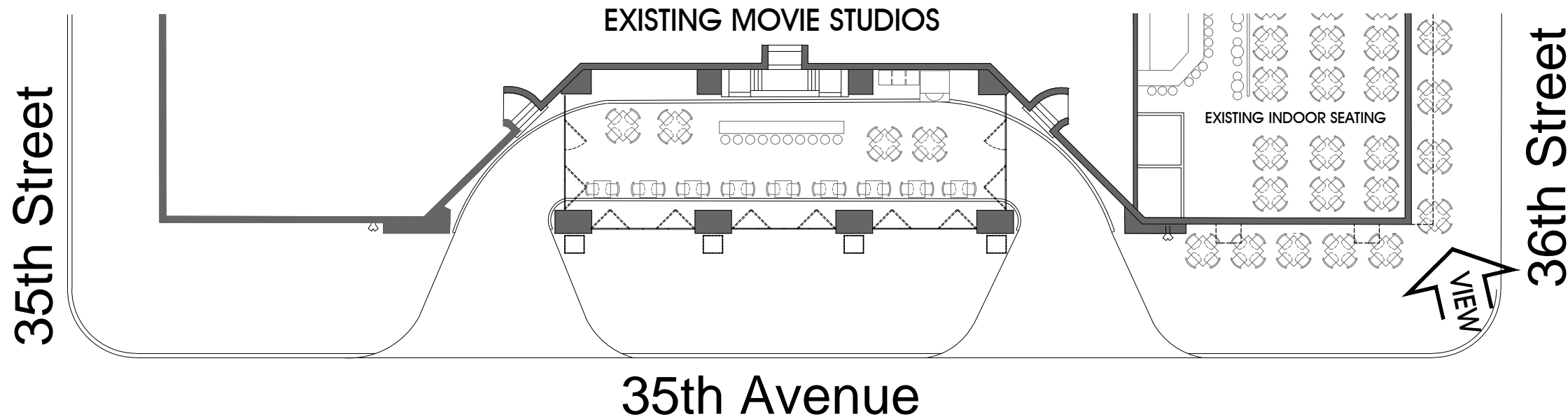
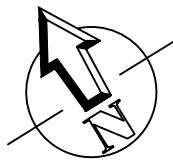



View of awnings
from the corner of
36th Street & 35th Avenue

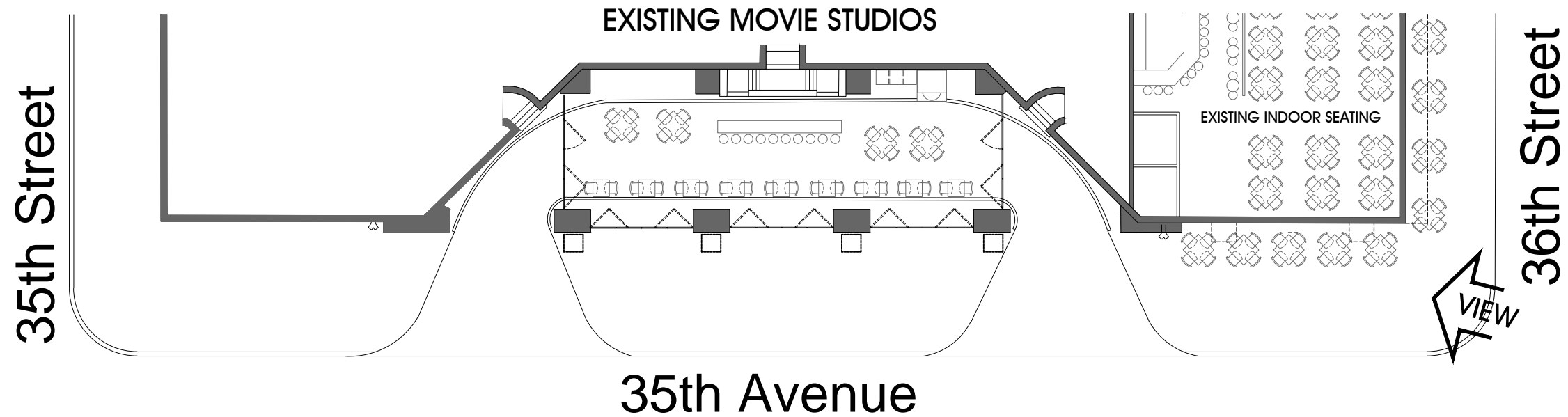
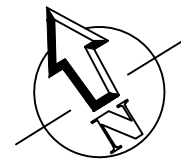



View of awnings from 35th Avenue

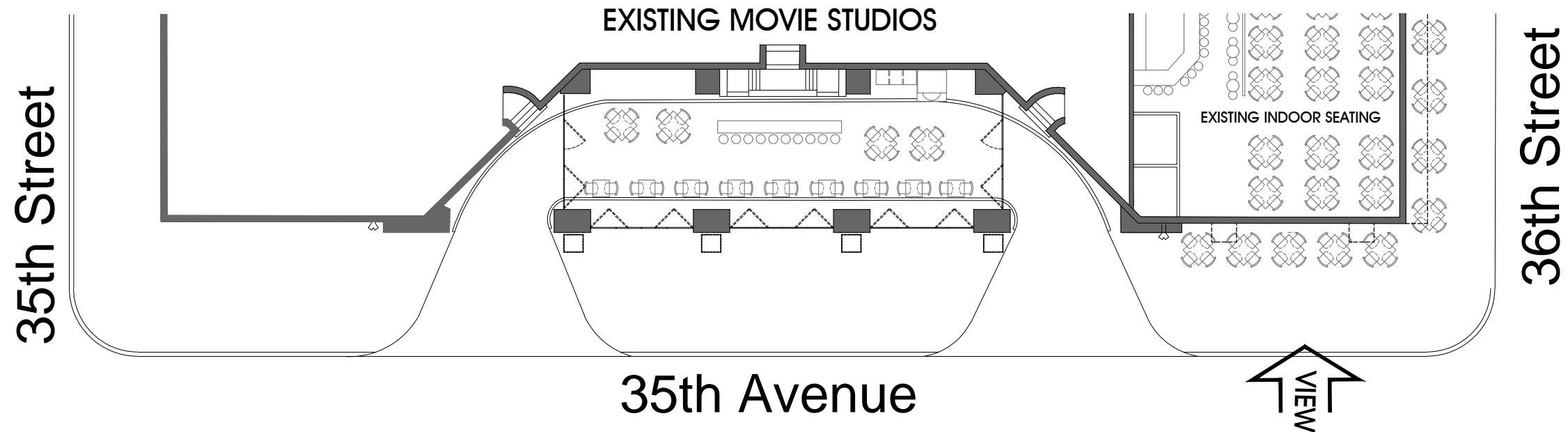
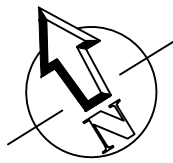



View of Porte Cochere looking East

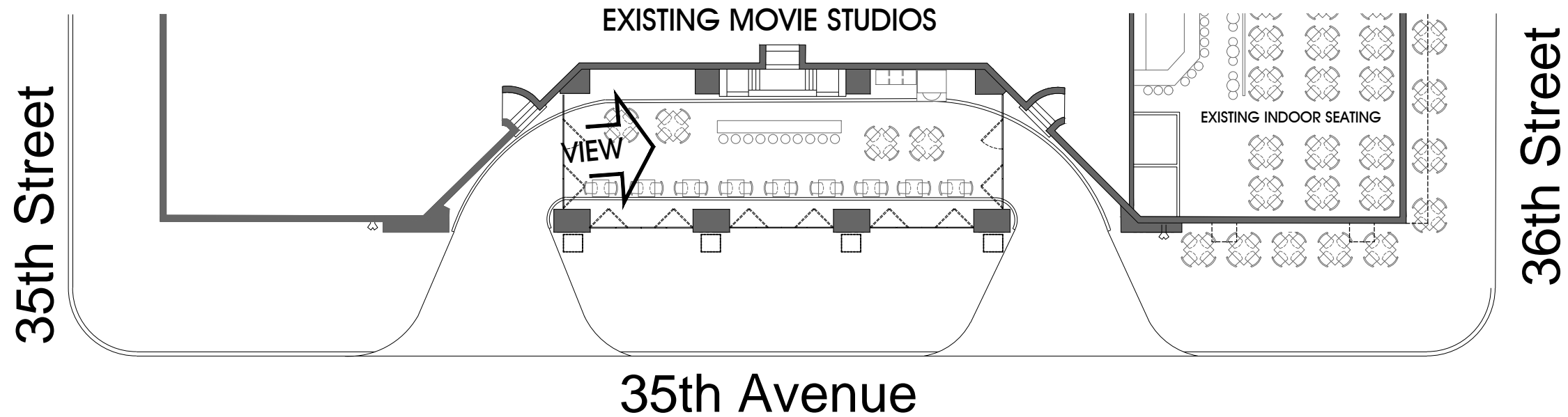
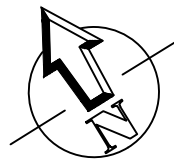

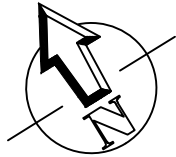

View of Bar Counter and Pizza Oven behind

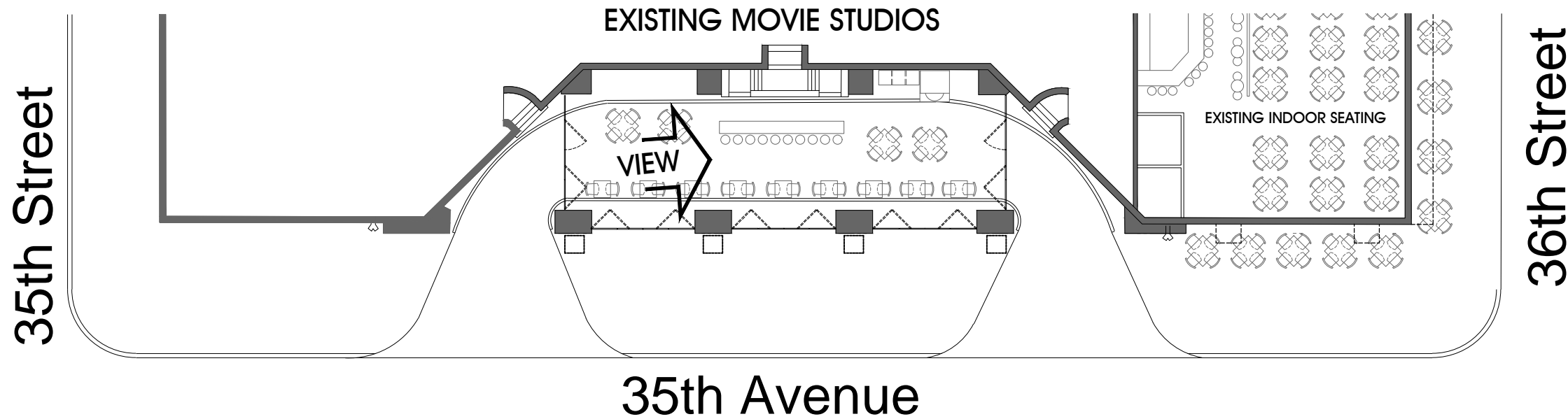



View of Porte Cochere
looking West

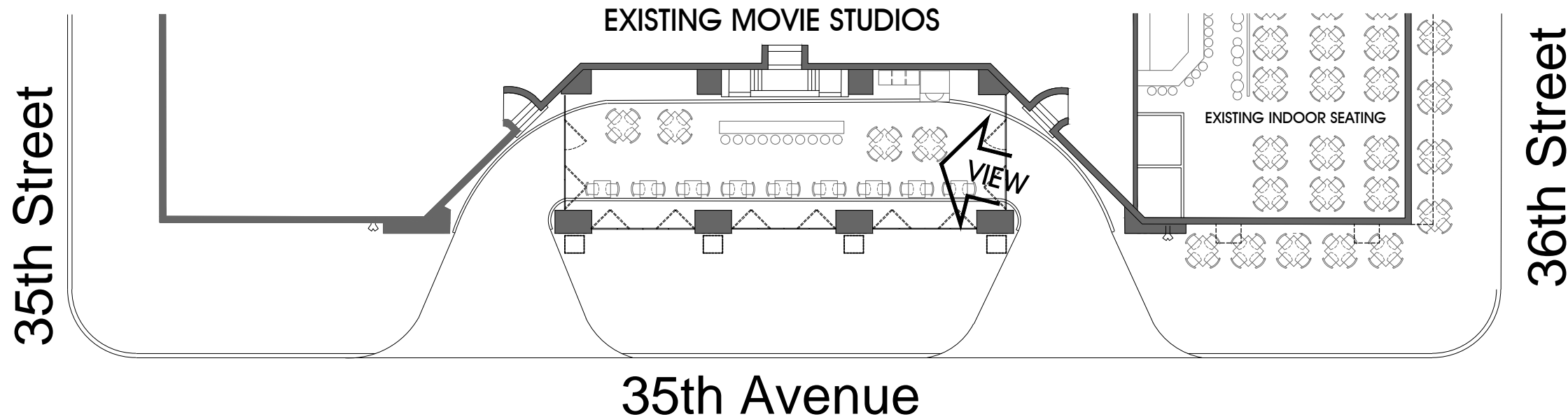
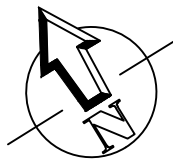



Close up of floor area above proposed underground piping

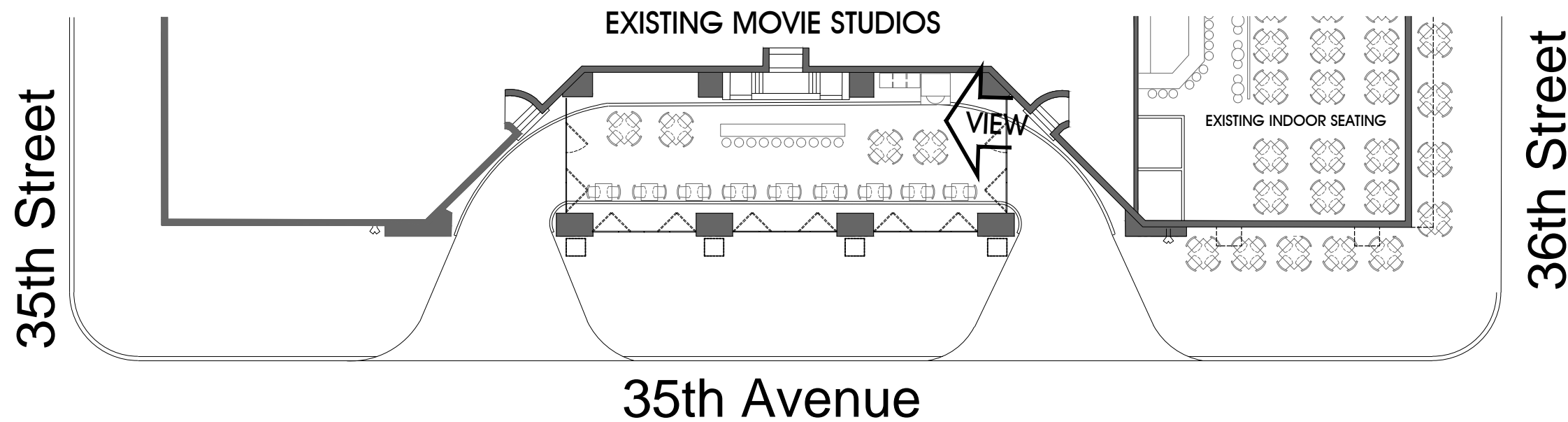
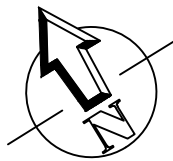

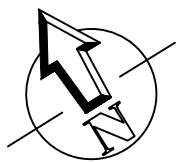

Close up of floor area above proposed underground piping

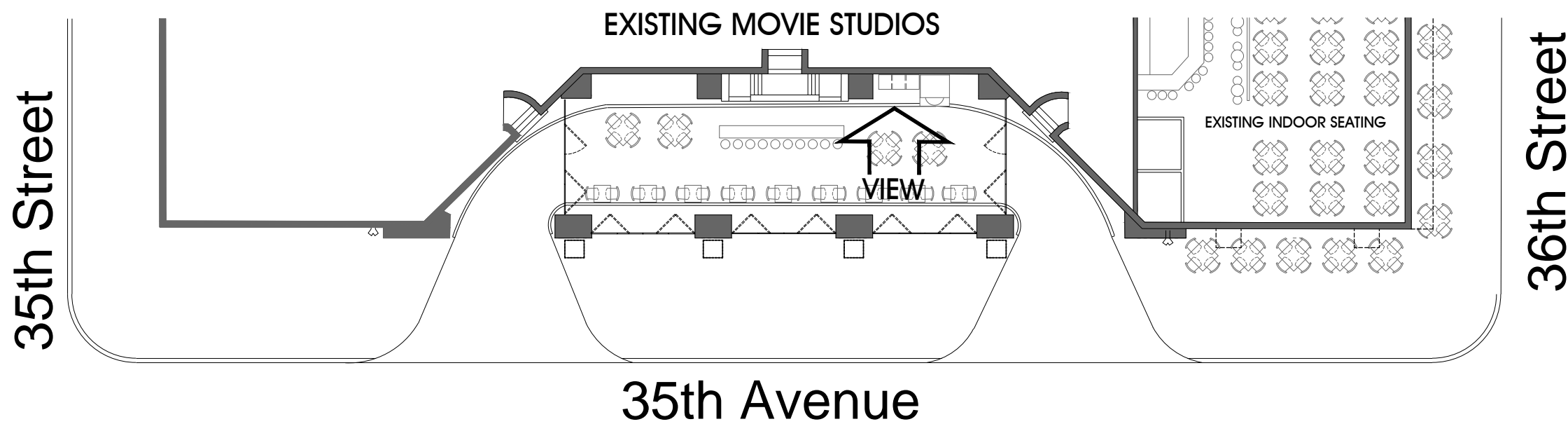



New Security Iron Gates

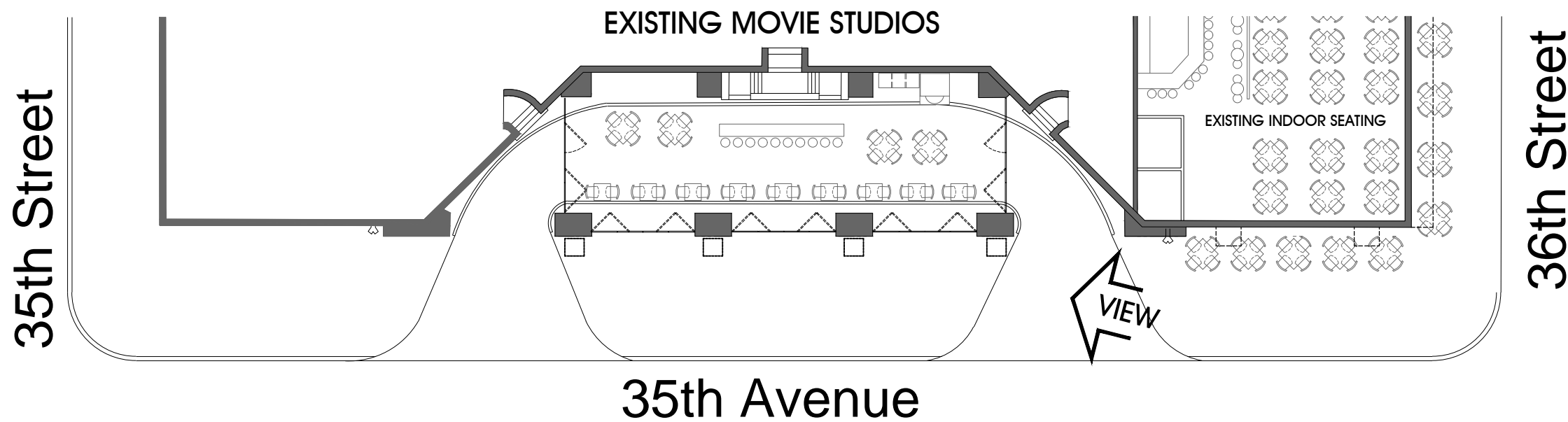
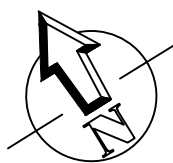

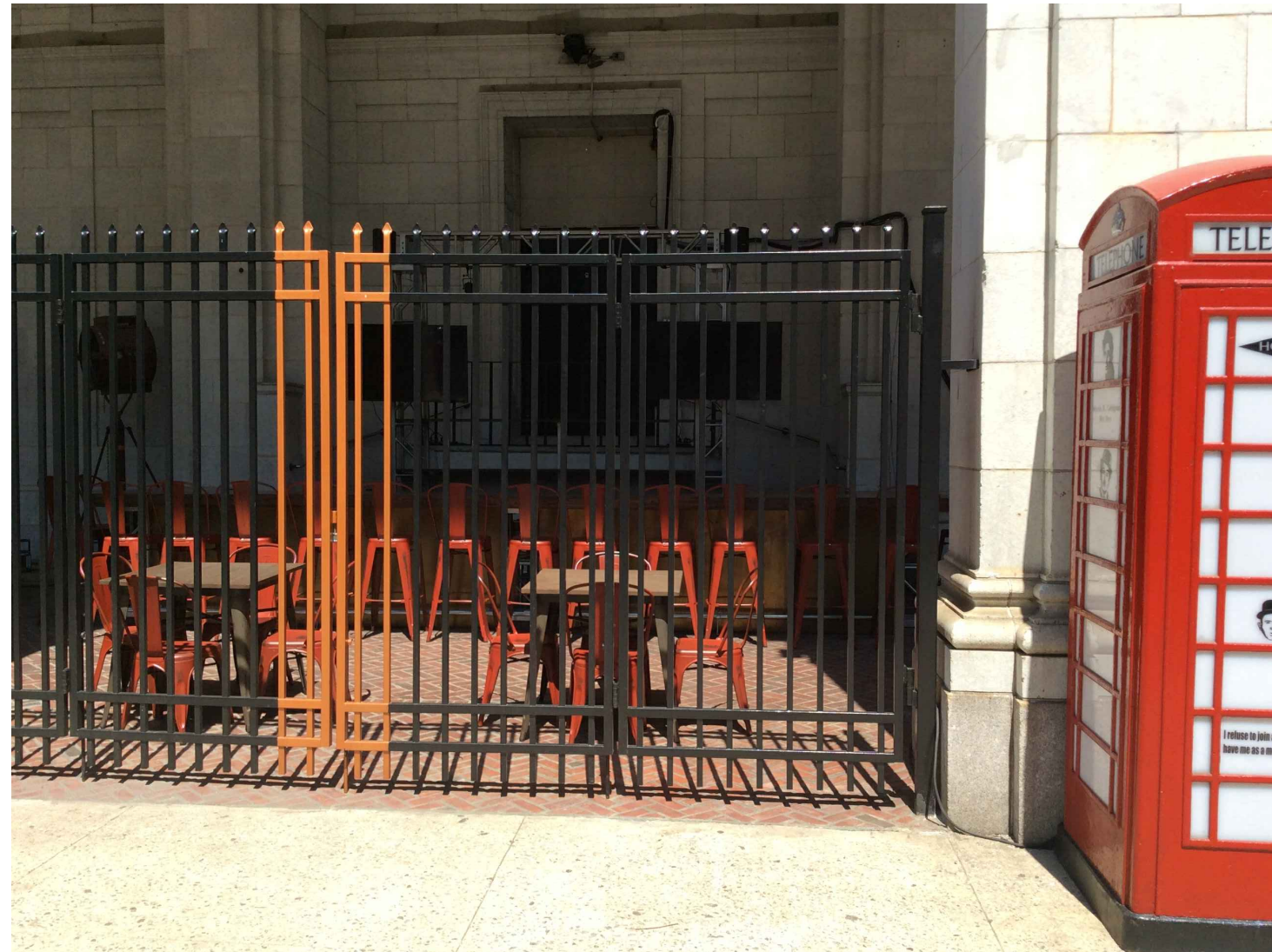

New Security Iron Gates

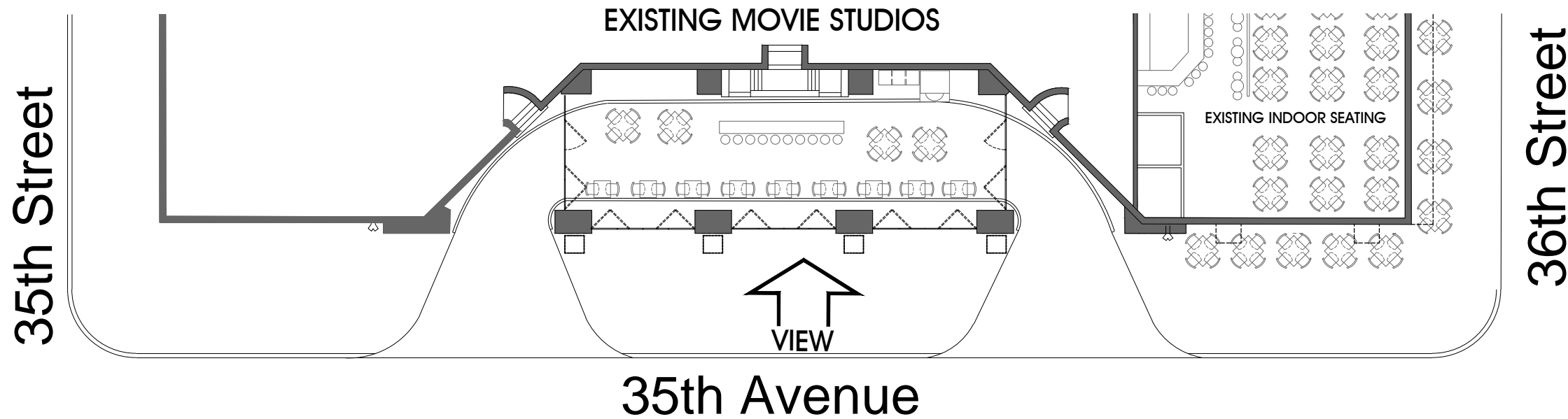
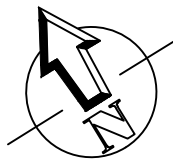

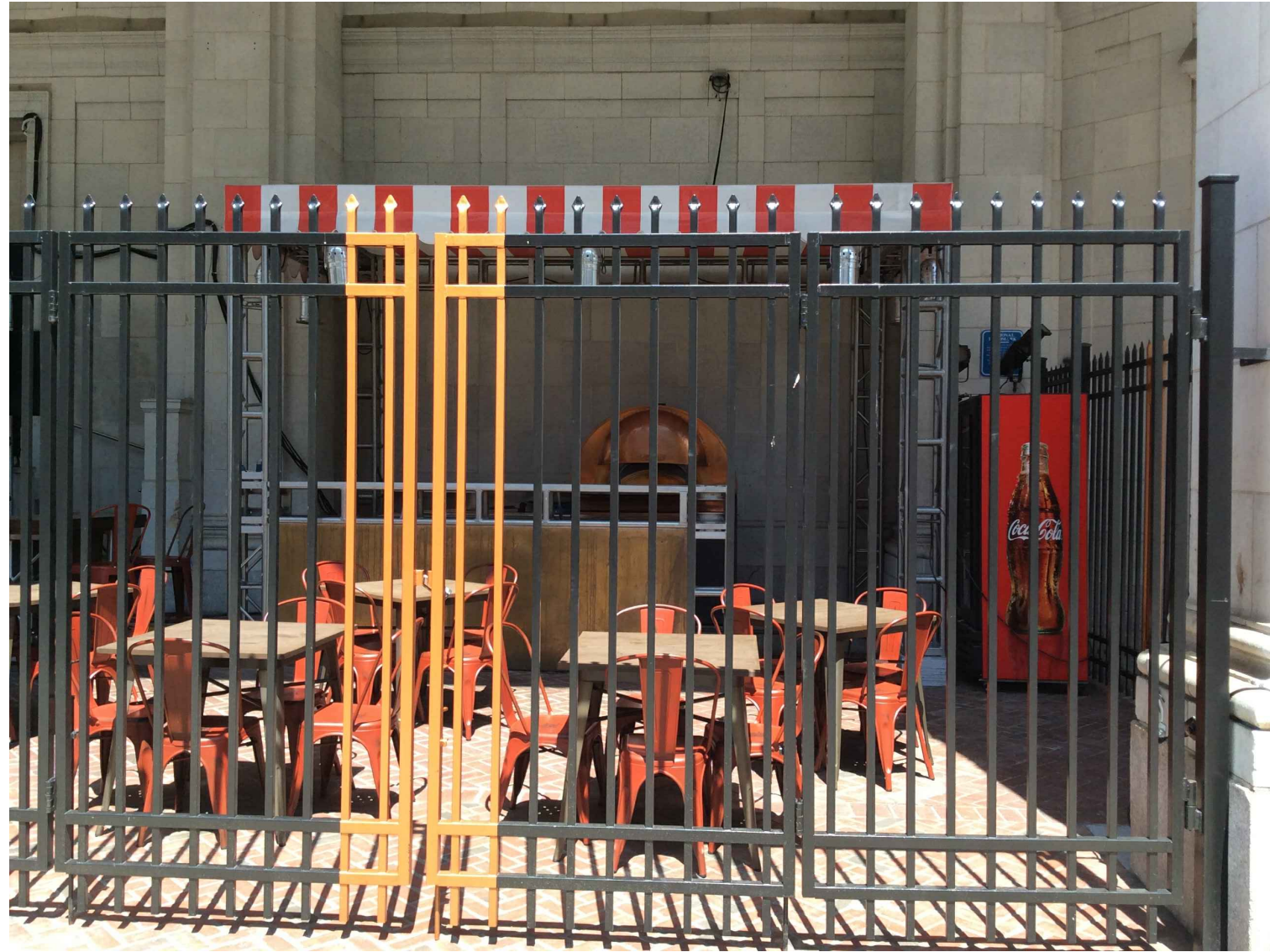

New Security Iron Gates

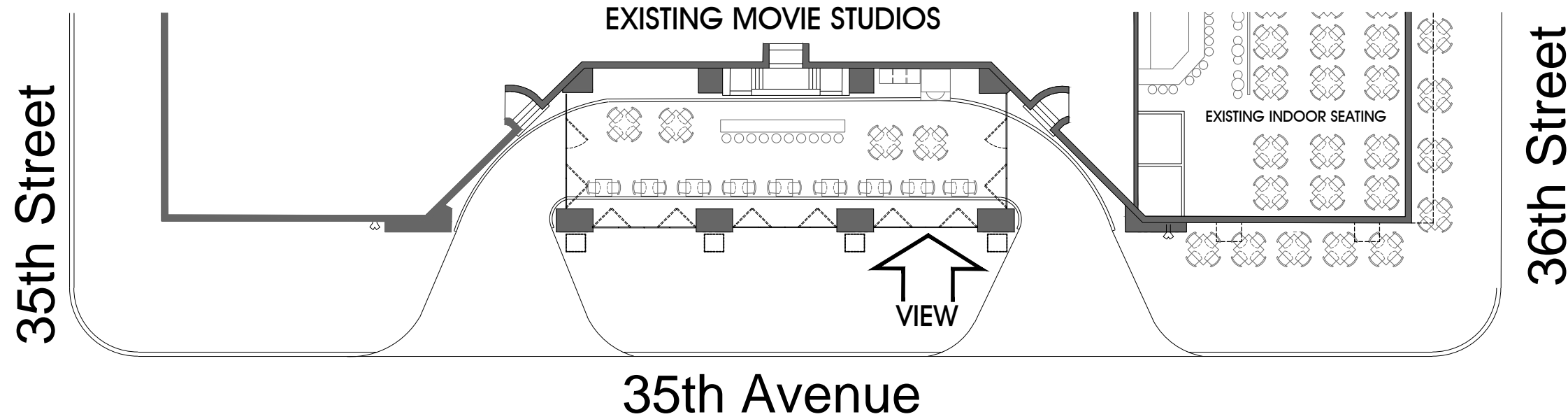
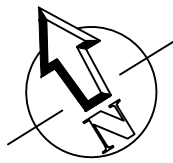

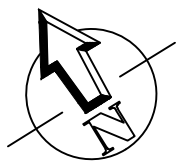

View of Porte Cochere
Suspended Light Fixtures

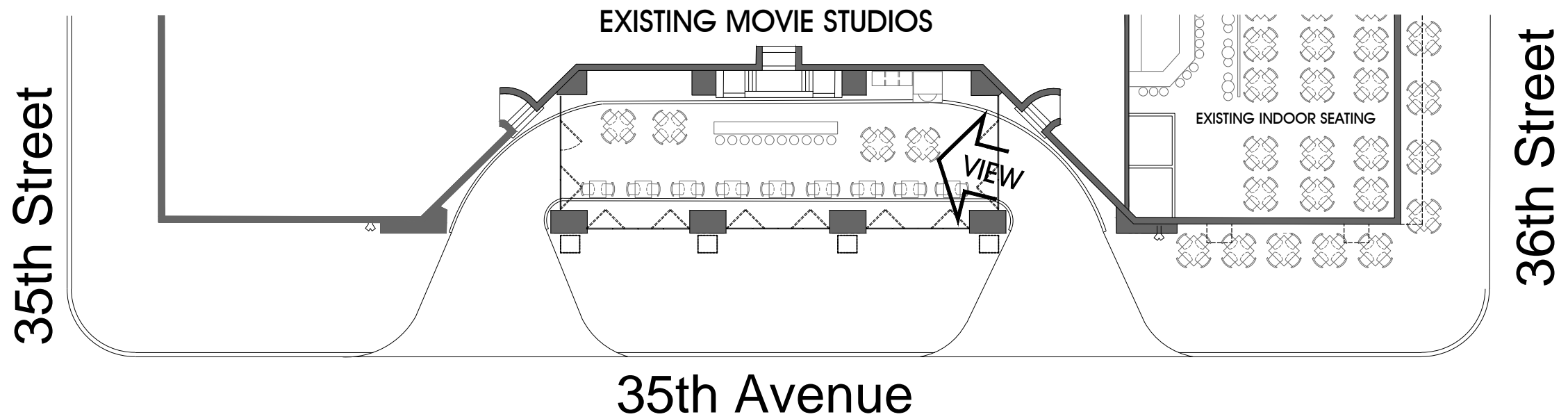

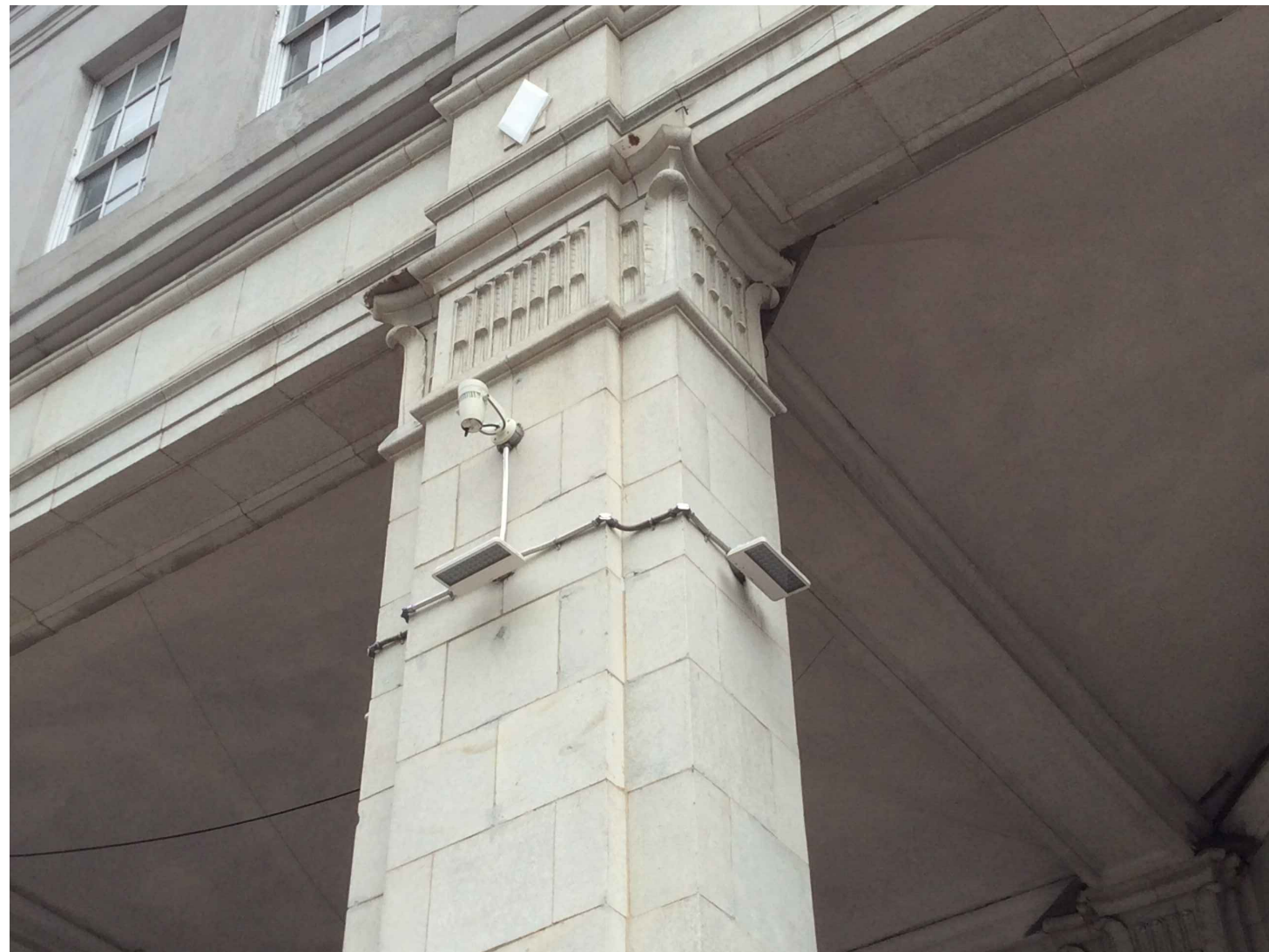
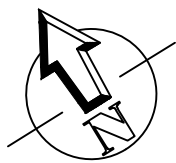

Close up View of Accent Lights

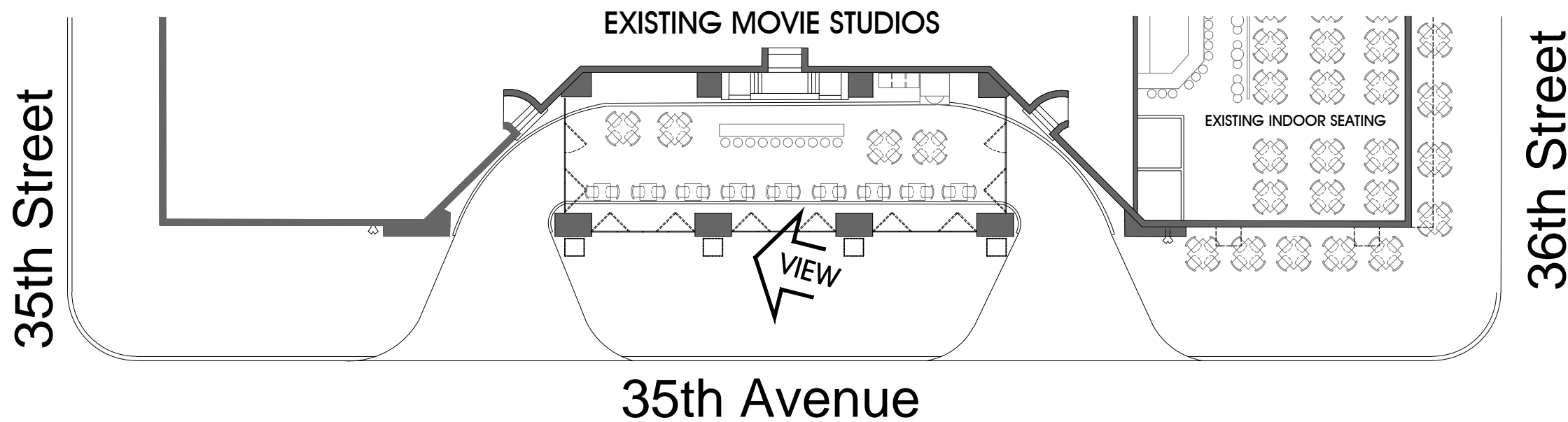

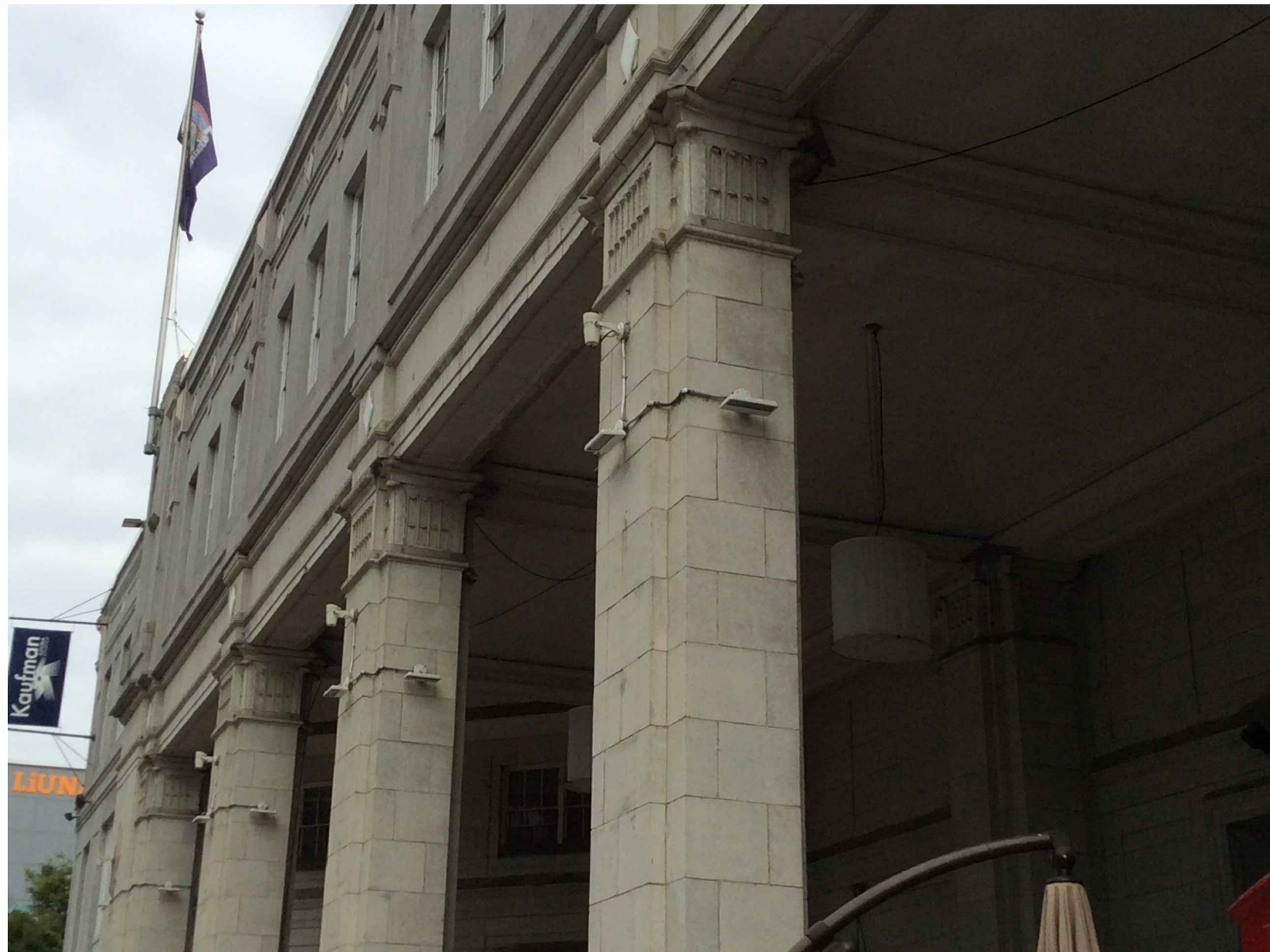
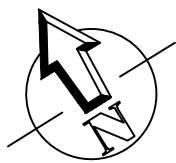

View of Accent Lights

