

FIRE DEPARTMENT • CITY OF NEW YORK



STUDY MATERIAL FOR THE EXAMINATION FOR THE CERTIFICATE OF FITNESS FOR SUPERVISION OF SPRINKLER SYSTEMS (CITYWIDE) S-12 SUPERVISION OF FOAM-WATER SPRINKLER SYSTEMS (CITYWIDE) S-15

This book is provided to the public for free by the FDNY.

NEW APPLICANTS (STARTING 6-6-16):

- **S-12** → FOR FACILITY WITHOUT FOAM-WATER SPRINKLER SYSTEMS
- **S-15** → FOR FACILITY WITH FOAM-WATER SPRINKLER SYSTEMS
- ▼
- **S-12** → SUPERVISION OF SPRINKLER SYSTEMS (CITYWIDE)
→ **75** QUESTION EXAM;
→ CHAPTER 1 TO CHAPTER 16 OF THIS STUDY MATERIAL
- **S-15** → SUPERVISION OF FOAM-WATER SPRINKLER SYSTEMS (CITYWIDE)
→ **100** QUESTION EXAM;
→ CHAPTER 1 TO CHAPTER 19 OF THIS STUDY MATERIAL (WHOLE BOOKLET)
CONSISTS OF THE CITYWIDE SPRINKLER SYSTEM QUESTIONS AND FOAM-WATER SPRINKLER SYSTEM QUESTIONS.
- **T-15** → FOAM-WATER SPRINKLER SYSTEMS ONLY
→ **25** QUESTION EXAM;
→ CHAPTER 1 TO CHAPTER 19 OF THIS STUDY MATERIAL (MAJORITY OF QUESTIONS ON THIS EXAM ARE COVERED BY CHAPTER 17 TO CHAPTER 19)
- **EXISTING S-12 C of F IS RENEWABLE AND CAN BE UPGRADED TO S-15 BY TAKING T-15 EXAM.**

All applicants are required to apply and pay for an exam online before arriving at the FDNY. It can take about 30 minutes to complete.

Simplified instructions for online application and payment can be found here:

<http://www1.nyc.gov/assets/fdny/downloads/pdf/business/fdny-business-cof-individuals-short.pdf>

Create an Account and Log in to:

<http://fires.fdnyccloud.org/CitizenAccess>

CONTENTS

NOTICE OF EXAMINATION	5
1. INTRODUCTION	12
1.1 SPRINKLER AND/OR STANDPIPE SYSTEM MAINTENANCE AND INSPECTIONS	12
2. RESPONSIBILITY OF THE BUILDING OWNER	13
3. OUT OF SERVICE SYSTEMS (OOS)	13
4. GENERAL PROCEDURE FOR RECORD KEEPING, IMPAIRMENTS AND SAFETY	18
5. INDIVIDUALS AUTHORIZED TO PERFORM TASKS AS SPECIFIED IN THE NEW YORK CITY FIRE CODE	19
6. DEFINITIONS.....	20
7. SYSTEM TYPES.....	26
7.1 AUTOMATIC WET SPRINKLER SYSTEMS	26
7.2 AUTOMATIC DRY SPRINKLER SYSTEMS	28
7.3 PREACTION SPRINKLER SYSTEMS	30
7.4 DELUGE SPRINKLER SYSTEMS.....	31
7.5 NON-AUTOMATIC DRY SPRINKLER SYSTEMS	31
7.6 GARBAGE COMPACTOR SPRINKLER SYSTEMS.....	31
8. WATER SUPPLIES FOR SPRINKLER SYSTEMS	33
8.1 CONTROL VALVES.....	33
8.2 SPRINKLER SYSTEM CONTROL VALVE SIGNAGE	34
8.3 FIRE DEPARTMENT CONNECTIONS	34
8.4 Gravity Tanks	35
8.5 Pressure Tanks.....	36
8.6 Fire Pumps.....	36
9. WATER-FLOW ALARMS AND SPRINKLER SYSTEM SUPERVISION	36
9.1 FUNCTIONS OF ALARMS AND SUPERVISORY SIGNALS.....	36
9.2 DEVICES AND EQUIPMENT SUPERVISED.....	37
10. SYSTEM COMPONENTS	38
10.1 SPRINKLER HEADS	38
10.1.1 <i>Four Types of Sprinkler Heads</i>	39
10.1.2 <i>Spray Pattern of Sprinkler Heads</i>	42
10.1.3 <i>Standard Response and Quick Response Heads</i>	42
10.1.4 <i>Systems Using Large Drop Sprinkler Heads</i>	43
10.2 TEMPERATURE RATINGS CLASSIFICATIONS AND COLOR CODING	44
10.3 BUILD-UP OF FOREIGN MATERIAL ON SPRINKLERS	44
10.4 SPARE SPRINKLER HEADS.....	45
10.5 PRESSURE TANKS	45
10.6 STANDARD PRESSURE TANK.....	46
10.7 GRAVITY TANKS.....	47
10.8 FIRE PUMPS	48
11. HANGING, BRACING AND RESTRAINT OF SPRINKLER SYSTEM PIPING	51
11.1 A BRIEF OVERVIEW OF PIPING AND SUPPORT FUNDAMENTALS	56
12. INSPECTION, TESTING AND MAINTENANCE FREQUENCIES	60
12.1 INSPECTION AND MAINTENANCE OF PRESSURE TANKS	60

12.2	INSPECTION AND MAINTENANCE OF THE GRAVITY TANK	60
12.3	PUMP INSPECTION AND MAINTENANCE	60
12.4	COMMON DEFICIENCIES	61
12.5	A COMPLETE SUMMARY OF TASKS OF INSPECTION, MAINTENANCE & TESTING	63
12.5.1	INSPECTION.....	63
A.	Sprinkler Systems:.....	63
B.	Fire, Booster and Special Service Pumps:.....	64
C.	Water Storage Tank:.....	65
D.	Valve and Valve Component:.....	66
12.5.2	TESTING.....	70
A.	SPRINKLER SYSTEMS:.....	70
B.	FIRE, BOOSTER AND SPECIAL SERVICE PUMPS:.....	71
C.	WATER STORAGE TANKS:.....	72
D.	VALVE AND VALVE COMPONENT:.....	72
12.5.3	MAINTENANCE.....	76
A.	SPRINKLER SYSTEMS:.....	76
B.	FIRE BOOSTER AND SPECIAL SERVICE PUMPS:.....	76
C.	WATER STORAGE TANK:.....	76
D.	VALVE AND VALVE COMPONENT:.....	77
12.6	REFERENCE GUIDES DEFINING INDIVIDUALS QUALIFIED AS TO WHOM CAN PERFORM INSPECTION, TESTING AND MAINTENANCE FOR WATER BASED FIRE SUPPRESSION PIPING SYSTEM.....	79
13.	INSPECTION, TESTING & MAINTENANCE OF WATER BASED SYSTEMS	
	INSPECTIONS ACTIVITIES AND RECORDS	89
14.	LOCAL LAW 58 of 2009	103
15.	OBSTRUCTION INVESTIGATION.....	105
16.	DIFFERENT TYPES OF SPRINKLER HEADS & COMPONENTS	106
17.	FOAM-WATER FIRE SUPPRESSION PIPING SYSTEM.....	115
17.1	INTRODUCTION.....	115
17.2	FOAM EXTINGUISHING SYSTEMS	115
17.3	FOAM TYPES ARE SUBDIVIDED INTO THREE RANGES.....	116
17.4	INITIAL INSTALLATION AND PERIODIC PERFORMANCE TESTING.....	117
17.5	MAINTENANCE.....	117
17.6	FOAM-WATER SPRINKLER SYSTEM TYPES.....	117
17.7	FOAM CONCENTRATE SOLUTIONS ARE SPECIFICALLY MANUFACTURED TO SUPPRESS DIFFERENT TYPES OF FIRES AND ARE GROUPED AS FOLLOWS:.....	118
17.8	FOAM ROOM.....	118
17.9	FOAM-WATER SPRINKLER AND SPRAY SYSTEM COMPONENTS	119
17.10	FOAM DELIVERY SYSTEM TYPES	120
17.11	FOAM EXTINGUISHING SYSTEMS SHALL BE COLOR-CODED AS FOLLOWS	120
18.	FORMER S-12 and NEW S-12: LIST OF MAJOR CHANGES.....	121
19.	LITHIUM-ION BATTERY SAFETY.....	123
20.	REFERENCE MATERIAL	126

NOTICE OF EXAMINATION

Title: **Examination for the Certificate of Fitness for Supervision of Sprinkler System (Citywide) (S-12) / Supervision of Foam-Water Sprinkler Systems (Citywide) (S-15)**

All applicants are required to apply and pay for an exam online before arriving at the FDNY. It can take about 30 minutes to complete.

Simplified instructions for online application and payment can be found here:

<http://www1.nyc.gov/assets/fdny/downloads/pdf/business/fdny-business-cof-individuals-short.pdf>

Create an Account and Log in to:

<http://fires.fdnyccloud.org/CitizenAccess>

REQUIREMENTS FOR WRITTEN EXAM

Applicants must be at least 18 years of age and must have a reasonable understanding of the English language. Applicants must apply the exam in person and bring the following materials and required fee:

1. **Identification.** Applicant must provide two forms of identifications; at least one form of identification must be government issued photo identification, such as a State-issued Drivers' License or Non Driver's License or a passport.
2. **Letter of Recommendation.** Applicants must present a letter of recommendation from his/her employer. The letter must be on official letterhead, and must state the applicant's full name, experience and the address where the applicant will work. If the applicants are self-employed or the principal of the company, they must submit a notarized letter attesting to their qualifications. For more info:
 - Sample of recommendation letter:
<http://www1.nyc.gov/assets/fdny/downloads/pdf/business/cof-samplerec-letter.pdf>
 - Sample of self-employed letter:
<http://www1.nyc.gov/assets/fdny/downloads/pdf/business/cof-sample-selfrec-letter.pdf>
3. **A-20.** Applicants must present a completed application for certificate of fitness (A-20 Form).
<http://www1.nyc.gov/assets/fdny/downloads/pdf/business/cof-application-form.pdf>
4. **Without Required Documentation.** Applicants not currently employed may take the exam without the required documentation. If the applicants pass the exam, FDNY will issue a temporary letter with picture for the job seeking purpose. The C of F card will not be issued unless the applicants are employed and provide all of the required documentation. *(Exception: If COF has a school requirement, applicant will not be allowed to take COF exam until school is completed.)*
5. **Special requirements for the:** T-15:

All T-15 applicants must hold a valid S-12 Certificate of Fitness. Applicants who do not have a valid S-12 Certificate of Fitness must apply for the S-12/S-15 Certificate of Fitness for supervising sprinkler systems.

6. **Application Fees:** Pay the \$25 application fee in person by one of the following methods:
- Cash
 - Credit card (*American Express, Discover, MasterCard, or Visa*)
 - Debit card (*MasterCard or Visa*)
 - Personal or company check or money order (*made payable to the New York City Fire Department*)

A convenience fee of 2 % will be applied to all credit card payments.

For fee waivers submit: ***(Only government employees who will use their C of F for their work-related responsibilities are eligible for fee waivers.)***

- A letter requesting fee waiver on the Agency's official letterhead stating applicant full name, exam type and address of premises; AND
- Copy of identification card issued by the agency

EXAM INFORMATION

The S-12 test will consist of **75** multiple-choice questions, S-15 will consist of **100** multiple-choice questions, and the T-15 will consist of **25** multiple-choice questions administered on a "touch screen" computer monitor. The tests are time-limit tests (approximately S-12: 135 minutes; S-15: 175 minutes; T-15: 38 minutes). A passing score of at least 70% is required in order to secure a Certificate of Fitness. Call (718) 999-1988 for additional information and forms.

Please always check for the latest revised booklet at FDNY website before you take the exam.

<https://www1.nyc.gov/assets/fdny/downloads/pdf/business/cof-s12-s15-noe-study-materials.pdf>

Special material provided during the test:

The following 3 materials will be provided to you as a reference material when you take the test at Metro Tech, however, the booklet will not be provided to you during the test.

1. Temperature Ratings Classifications and Color Coding Table
2. Reference Guide for inspection, testing and maintenance
3. Inspection Testing and Maintenance of Sprinkler Systems Activities & Records
4. Reference guide for inspection, testing and maintenance S-95 Supervision for Fire alarm Systems & other related system

If all the requirements are met and the applicant passes the exam, a certificate will be issued on the same day. Applicant who fails the exam will receive a failure report. To retake the exam applicants will need to submit a new application and payment.

OTHER RELATED FEES

To change a mailing address:

Submit a letter requesting the change of mailing address and a copy of your C of F with \$5.00 fee.

To change a work location,

Submit a letter from your current employer (on company letterhead) confirming that you are an employee and stating your new work location with a copy of your C of F and a \$5.00 fee

To request a replacement certificate:

Submit a driver's license or passport, social security number, mailing address and a \$5.00 fee.

RENEWAL REQUIREMENTS

This Certificate of Fitness must be renewed every **THREE YEARS**. The renewal fee is **\$15**. FDNY also reserves the right to require the applicants to take a re-examination upon submission of renewal applications.

You will receive a courtesy notice of renewal 90 days before the expiration date. However, it is your responsibility to renew your Certificate. It is very important to renew your C of F before it expires. Renewals submitted 90 days (up to one year) after the expiration date will incur a \$25 penalty in addition to the renewal fee. Certificates expired over one year past expiration date will not be renewed. New exams will be required.

The certificate can be renewed **On-line, by Mail** or **in Person**.

- **Renewal online**

If you are an individual, make sure you have your 12 digit Certificate of Fitness Access ID. This can be found on your Renewal Notice. If you do not have your Renewal Notice, your Access ID is your 8 digit Certificate of Fitness number and the last four digits of your social security number. If you are submitting renewals on behalf of a company's employees, the company must be approved by FDNY and have an 8 digit Company Code. To request approval, email pubrenew@fdny.nyc.gov.

Renewal fee can be paid by one of the following methods:

- Credit card (American Express, Discover, MasterCard, or Visa)
- Debit card (MasterCard or Visa)
- E-check

Fee exempted applicants cannot renew online only by mail or in person.

If all the requirements are met, the certificate of fitness will be mailed out within 10 days.

For online renewal go to: <https://a836-citypay.nyc.gov/citypay/FDNYCOF>

- **Renewal by mail**

Mail your Renewal Notice (or if you did not receive a Renewal Notice, a copy of your certificate), along with your fee payment, Personal or company check or money order (made payable to the New York City Fire Department)

For fee waivers submit: ***(Only government employees who will use their C of F for their work-related responsibilities are eligible for fee waivers.)***

- A letter requesting fee waiver on the Agency's official letterhead stating applicant full name, exam type and address of premises; **AND**
- Copy of identification card issued by the agency and if applicable, supporting documents to:

NYC Fire Department (FDNY)

Cashier's Unit

9 MetroTech Center, 1st Floor

Brooklyn, NY 11201

If all the requirements are met, the certificate of fitness will be mailed out within four to six weeks.

- **Renewal in person**

Submit your Renewal Notice (or if you did not receive a Renewal Notice, a copy of your certificate), along with your fee payment by one of the following methods:

- Cash
- Credit card (*American Express, Discover, MasterCard, or Visa*)
- Debit card (*MasterCard or Visa*)
- Personal or company check or money order (*made payable to the New York City Fire Department*)

A convenience fee of 2 % will be applied to all credit card payments for original or renewal certificates.

For fee waivers submit: ***(Only government employees who will use their C of F for his or her work-related responsibilities are eligible for fee waivers.)***

- A letter requesting fee waiver on the Agency's official letterhead stating applicant full name, exam type and address of premises; **AND**
- Copy of identification card issued by the agency and if applicable, your supporting documents to:

NYC Fire Department (FDNY)

Cashier's Unit

9 MetroTech Center, 1st Floor

Brooklyn, NY 11201

If all the requirements are met, the certificate of fitness will be issued the same day.

Test Site: FDNY Headquarters, 9 Metrotech Center, Brooklyn, NY. Enter through the Flatbush Avenue entrance (between Myrtle Avenue and Tech Place).

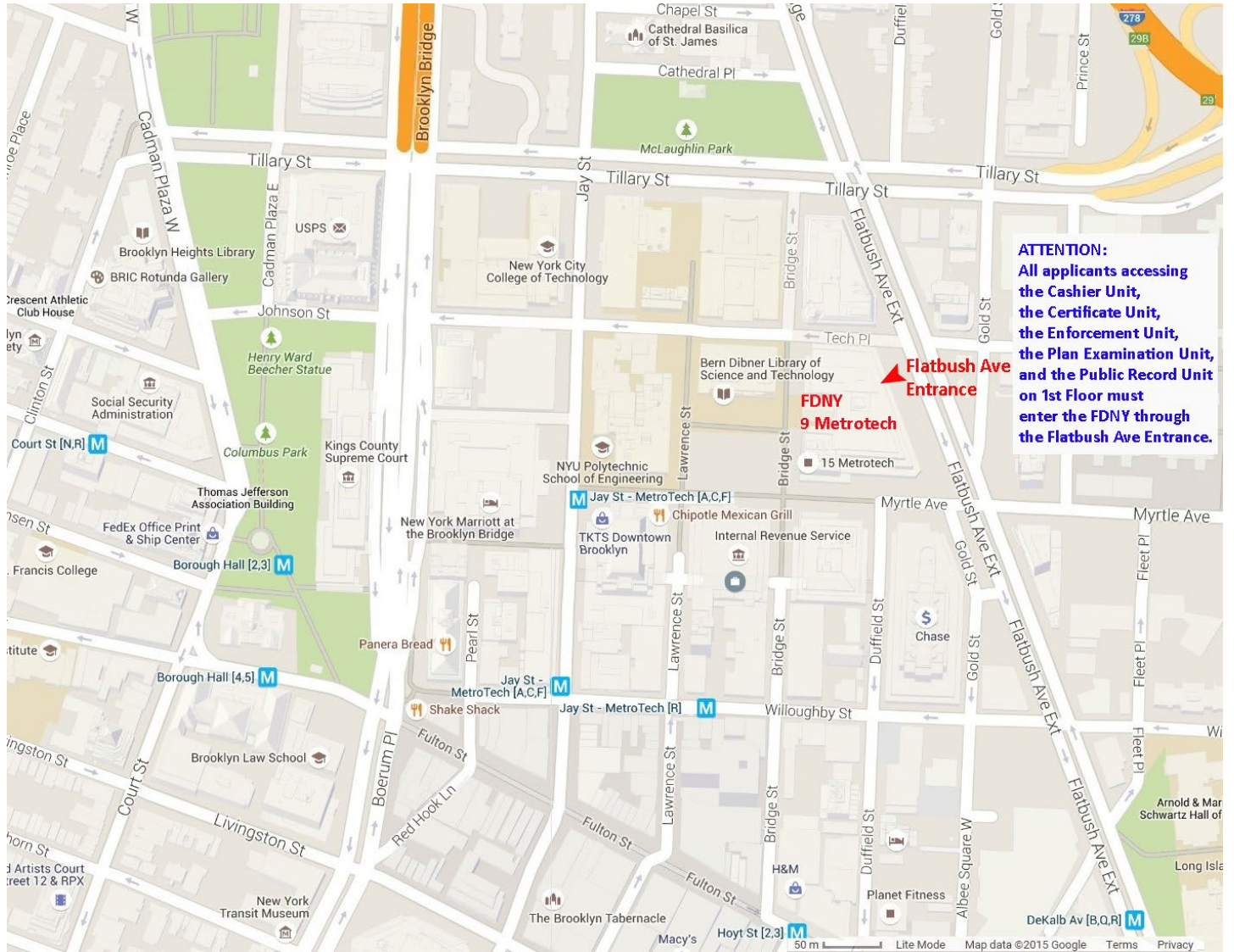

STUDY MATERIAL AND TEST DESCRIPTION

ABOUT THE BOOKLET

This study material will help you prepare for the written examination for the Certificate of Fitness for Sprinkler Systems. The study materials include information taken from the 2014 New York City Fire Code (FC) Chapter 9, Fire Department Rules Chapter 9 and NFPA Standard 25, **(2011 Edition)** Inspection, Testing and Maintenance of Water Based Fire Protection Systems. **It is critical that you read and understand this booklet to help increase your chances of passing this exam.**

ABOUT THE TEST

All questions on the Certificate of Fitness examination are multiple choice, with four alternative answers to each question. Each question has only one correct answer. If you do not answer a question or if you mark more than one answer you will be scored as incorrect. A score of not less than 70% correct is required on the examination in order to qualify for the Certificate of Fitness. Read each question carefully before marking your answer. There is no penalty for guessing.

SAMPLE QUESTIONS

The following questions represent the "format" of the exam questions, not the content of the real exam.

1. Which of the following are allowed to be used while taking a Certificate of Fitness examination at 9 Metro Tech Center?

- I. cellular phone
 - II. study material booklet
 - III. reference material provided by the FDNY
 - IV. mp3 player
- A. III only
 - B. I, II, and III
 - C. II and IV
 - D. I only

Only reference material provided by the FDNY is allowed to be used during Certificate of Fitness examinations. Therefore, the correct answer would be A. You would touch "A" on the computer terminal screen.

2. If the screen on your computer terminal freezes during your examination, who should you ask for help?

- A. the person next to you
- B. the firefighters in the testing room
- C. the examiner in the testing room
- D. the computer help desk

If you have a computer related question, you should ask the examiner in the testing room. Therefore, the correct answer would be C. You would touch "C" on the computer terminal screen.

3. If you do not know the answer to a question while taking an examination, who should you ask for help?

- A. the person next to you
- B. the firefighters in the testing room
- C. the examiner in the testing room
- D. you should not ask about test questions since FDNY staff cannot assist applicants

You should not ask about examination questions or answers since FDNY staff cannot assist applicants with their tests. Therefore, the correct answer would be D. You would touch "D" on the computer terminal screen.

1. INTRODUCTION

A sprinkler system is a fire extinguishing system, other than a water mist system, that utilizes water as the extinguishing agent. Whether a building shall be provided with sprinkler protection or not is generally set forth in the NYC Building Code. Inspection, testing, servicing and other maintenance of sprinkler systems must be **personally supervised** and be performed in accordance with NFPA (National Fire Protection Association) #25 2011 edition.

All multiple dwellings, factories, office buildings, warehouses, stores and offices, theaters and music halls, hospitals and asylums, and all public schools and other public buildings, churches and other places where large numbers of persons are congregated for purposes of worship, instruction, amusement, and all piers, bulkheads, wharves, pier sheds, bulkhead sheds or other waterfront structures shall provide such fire hose, fire extinguishers, buckets, axes, fire hooks, fire doors and other means of preventing and extinguishing fires as the commissioner may direct.

Required fire protection systems shall be extended or altered as necessary to maintain and continued protection whenever the building or structure is altered. Systems not complying with this section shall be considered to be impaired.

It shall be unlawful to install or maintain any fire protection system or device that has the physical appearance of fire protection equipment but that does not perform a fire protection function where it may be confused with actual fire protection equipment. An example would be a CCTV camera that is installed inside a shell that resembles a sprinkler head (as seen in the image on the right).



1.1 SPRINKLER AND/OR STANDPIPE SYSTEM MAINTENANCE AND INSPECTIONS

1. Automatic and non-automatic sprinkler systems shall be inspected, tested and maintained as required by NFPA #25 2011 edition by a competent person holding a S-12 Certificate of Fitness and employed or contracted by the owner, to see that all parts of the system are in good working order, and that the Fire Department connection(s), if any, are ready for immediate use by the Fire Department. A detailed record shall be kept on the premises or other approved location, for a minimum of 3 years for examination by any representative of the Fire Department.
2. A supply of at least six extra sprinkler heads shall be kept available on the premises, to replace promptly any fused or damaged sprinklers. Any head which has opened or has been damaged shall be replaced immediately with sprinkler

head of similar characteristics such as operating temperature, orifice size, deflector orientation and thermal sensitivity.

3. At least once every five years, the Fire Department connection or connections for a sprinkler system shall be subjected to a hydrostatic pressure test to demonstrate its suitability for Fire Department use. The test shall be arranged to be conducted by a Master Fire Suppression Piping Contractor in the presence of a Fire Department representative. The contractor shall be hired by the owner or the owner's representative.
4. There shall be one or more employees or individuals contracted by the owner with a Certificate of Fitness to inspect the sprinkler system following the standard of the NFPA 25 of 2011.

2. RESPONSIBILITY OF THE BUILDING OWNER

It shall be the owner's responsibility to maintain the sprinkler system and to determine the individual qualifications and competencies of the COF holder that performs the functions related to inspection, testing and maintenance of such system.

Impairment Coordinator: The building owner shall assign an impairment coordinator to comply with the requirements of study material. The impairment coordinator shall take the action(s) when a standpipe system, sprinkler system or fire alarm system is out of service.

The impairment coordinator shall maintain records of all system inspections, tests, servicing and other items of maintenance shall be kept on the premises or other approved location for a minimum of 3 years and made available for inspection by any member of the FDNY. In absence of a specific designee, the building owner shall be considered the impairment coordinator.

3. OUT OF SERVICE SYSTEMS (OOS)

Planned removal from service: When the system, or a portion of the sprinkler system, is placed out of service for a scheduled inspection, testing, regular maintenance, minor repairs or for construction affecting not more than 1 floor, the Certificate of Fitness holder and the impairment coordinator shall be made aware of and authorize the placing of the system out of service.

Unplanned out of service condition: A serious defect in the sprinkler system including, but not limited to: an empty tank, a break or major leak in the system's water piping, inoperative or shut water supply valves, defective fire department connections, construction related shut downs affecting more than one floor, or complete or partial shut downs of the sprinkler system, other than a shut down for a planned removal from service.

When a Fire Protection system is out of service fire watch personnel must:

- Continuously patrol the area affected by the out-of-service fire protection system to which such person has been assigned, keeping constant watch for fires.

- Be provided with at least one approved means for notification of the Fire Department and emergency preparedness staff.
- Immediately report any fire to the Fire Department and notify emergency preparedness staff on premises.
- Be trained in the used of portable fire extinguisher.
- Be responsible for extinguishing fires limited in size and spread that can be readily extinguished.
- Maintain a record of such fire watch on the premises during the fire watch and for a minimum of 48 hours after the fire watch has concluded.
- Have no other duties.

FIRE DEPARTMENT NOTIFICATIONS FOR OUT OF SERVICE CONDITIONS:

NOTIFICATION THAT A SPRINKLER SYSTEM OR FIRE ALARM SYSTEM, OR ANY PART THEREOF, IS OR WILL BE OUT OF SERVICE SHALL BE MADE TO THE FIRE DEPARTMENT UNDER THE FOLLOWING CIRCUMSTANCES:

1. The sprinkler system or fire alarm system is or will be out of service on **more than one floor of a building**; or
2. **The work or repairs cannot be completed, and the system restored to service, within 8 hours** of the time the system was placed or went out of service; or
3. With respect to a fire alarm system, the work or repairs will require the fire alarm system to be out of service for more than 8 hours in any 24-hour period; or
4. **One or more other fire protection systems** in the area in which a fire protection system is out of service are or **will also be out of service at the same time.**

The telephone numbers are as follows:

Manhattan	212-570-4300
Bronx	718-430-0200
Brooklyn	718-965-8300
Queens	718-476-6200
Staten Island	718-494-4296

- a) The initial Fire Department notification shall include the following:
 1. A brief description and extent of the out-of-service condition and system it affects.
 2. The area of the building affected, including the floors where fire protection system is out of service.
 3. The type of occupancy.
 4. The estimated time the system will be out of service.
 5. The name and phone number of the person making the notification or the owner of the premises.
 6. The building address.
 7. Whether the fire protection system is out of service by reason of a planned removal from service (and if so, the reason for placing it out of service) or an unplanned out-of-service condition.
 8. Whether or not the other fire protection systems are in good working order.

- b) When the Certificate of Fitness holder observes a minor defect or other condition not presenting a serious safety hazard, he or she shall report the defect or condition to the owner, and if the defect or condition is not corrected within 30 days it shall be deemed to be an impairment and reported in writing to the Fire Department (FC 901.7.5). Correspondence should be sent via email spkstp@fdny.nyc.gov or by certified documents to:

**New York City Fire Department
Bureau of Fire Prevention
Fire Suppression Unit, 3rd Floor
9 Metro Tech Center
Brooklyn, New York 11201**

Identifying OOS Systems Using Discs/Tags: Systems that are out of service, both planned and unplanned, shall be immediately identified by placing a tag at each of the following locations: **Fire Department connections, system control valves, fire command center or other clearly visible location in the lobby of the building**, indicating which system or part thereof is out of service. Impairment coordinators/building owners shall ensure the placement of these tags by MFSPC's or MP (as restricted). In addition, for an unplanned out of service condition, a disc (white or blue) shall be placed at all affected fire department connections to inform responding Fire Department units of the out of service condition. The impairment coordinator/building owner shall ensure placement of these discs by MFSPC's, MP's (as restricted) or FDNY units. When the condition has been corrected, the disc(s) shall be removed immediately.

Tag Requirement: A tag shall be used to indicate that a system, or portion, is out of service. A Master Fire Suppression Piping Contractor, Class A or B, or a master plumber (as restricted), shall be required to post tags at the main control valve and at any closed sectional valves serving areas affected. The tag shall indicate the area affected, a brief description of the condition, the occupancy classification, C or F number and the estimated time until the system becomes operational.

Drain test results shall be posted on the tag indicating both the static and flow pressures before and after the system was placed in an out of service condition.

If no impairment is found in the entire system **green** tags will be placed on the **main control valve**.

Example of FDNY White and Blue Discs

SYSTEMS PARTIALLY OR FULLY OUT OF SERVICE:

Systems Fully Out of Service: The impairment coordinator/building owner shall ensure that the local administrative fire company, Master Fire Suppression Contractor (Class A or B) or MP's (as restricted) has placed one **White** disc 8 to 9 inches in diameter on all affected fire department connections. **A RED** tag shall be placed at the main control valve indicating the sprinkler company name, date of removal from service and anticipated return to service date.



Systems Partially Out of Service: The impairment coordinator/building owner shall ensure that the local administrative fire company, FSPC's or FDNY units Master Fire Suppression Contractor Class A or B has placed one **Blue** Disc 8 to 9 inches in diameter on all affected fire department connections. An **Red** tag shall be placed at the main control valve and any closed sectional valve indicating the company name, date of removal from service and anticipated return to service date.

The impairment coordinator shall authorize the placement of system(s) out of service that are planned to be shut down. The impairment coordinator shall notify the Certificate of Fitness holder about the system(s) that is/are out of service.

Planned removal from service. The impairment coordinator shall be made aware in advance of any planned removal from service of a standpipe system, sprinkler system or fire alarm system, or system component, for repair, servicing, alteration, testing and other maintenance of the system or component, or to allow construction to be performed in the area protected by the system without unnecessarily activating it. The impairment coordinator shall authorize and personally supervise the placing of the fire protection system out of service. Before authorizing the placing of the fire protection out of service the impairment coordinator shall:

- Notify the Certificate of Fitness holder responsible for supervising the maintenance of the standpipe system, sprinkler system or fire alarm system.
- Determine the extent and expected duration of the out-of-service condition.
- Inspect the areas or buildings involved and assess the increased risks.
- Make appropriate recommendations to the owner.
- Notify the Fire Department in accordance with FC 901.7.5, if required.
- Notify the responsible person designated by the owner to issue hot work authorizations in accordance with FC Chapter 26.
- Notify the central station and insurance carrier.
- Notify the occupants in the affected areas if the duration of time the sprinkler system or fire alarm system will be out of service is estimated to be more than 30 minutes.
- Place a tag at each fire department connection, standpipe and sprinkler system control valve and fire command center, indicating which fire protection system, or part thereof, is out of service.
- Maintain the fire protection system in service until work is ready to begin.

Fire Guard

The impairment coordinator or other building staff trained and knowledgeable in conducting a fire watch may conduct a fire watch in lieu of a fire guard during the initial 4 hours of a planned removal from service, or after discovery of an unplanned out-of-service condition, provided that the floor or area in which the fire protection system is out of service does not exceed 50,000 square feet. A sufficient number of fire guards shall be provided such that each floor or area in which the fire protection system is out of service is patrolled at least once an hour.

Impaired Equipment: Underground service mains, water storage tanks, Fire Department connections, control valves, fire and or booster pumps, that are out of service and are considered vital to part of the system that are required to be tagged following procedures outlined in Chapter 15 of NFPA #25 2011 Ed.

Tags placed at control valves shall indicate the level of impairment or defect as follows:

	<u>Tag</u>	<u>Disc</u>
System fully out of service	Red	White
System partially out of service	Red	Blue
System appears free of defects or deficiencies	Green	N/A

Only FDNY, Owner, MFSPC or MP (as restricted) may place a tag on a system. For systems that are fully or partially out of service that are not equipped with Fire Department connections, the appropriate tags shall be placed at the main control valve. FDNY is to be notified immediately.

In a building required by the NYC Fire Code to have a Fire Safety Director with (F-58 or F-25), an Engineer (Q-01 or Q-99) with the S-12 C of F, is authorized to take the system out of the service for less than 8 hrs and place an appropriate colored tag on that system. The FSD and the Engineer must be on the premises at the all times.

Prior to returning a system to service, the impairment coordinator shall ensure that the necessary tests and inspections are conducted to verify that the system is operating normally, notify FDNY borough dispatcher, the building owner's tenants in the affected area, the insurance carrier, emergency preparedness staff, central station operator (if so equipped) and remove out of service tags and discs.

Protection of Sprinkler Systems

All parts of an automatic system exposed to freezing temperatures shall be protected from freezing or in lieu thereof, an automatic dry pipe system or a system filled with a nonfreezing, noncombustible solution shall be used. When a system filled with a nonfreezing solution is used and the system is connected to a potable (drinking) water supply, it shall be subject to the requirements of the Health Department and the Bureau of water supply of the Department of Environmental Protection and may require that a backflow preventer be installed. Approved nonfreezing solutions include glycerin not greater than 48%, and propylene glycol not greater than 38% non-freezing solution. Sprinkler heads subject to damage shall be protected.

4. GENERAL PROCEDURE FOR RECORD KEEPING, IMPAIRMENTS AND SAFETY

It shall be the responsibility of the Certificate of Fitness holder to perform the following:

Record keeping. The Certificate of Fitness holder shall maintain a **detailed record** of all inspections.

Records. Records of all system inspections, tests, servicing and other maintenance required by this NYC Fire Code, the NYC Fire Rules or the referenced standards shall be maintained on the premises or other approved location for a minimum of 3 years and made available for inspection by any Fire Department representative. (FC 901.6.2)

Detailed Records. A detailed inspection report shall include information relative to conditions of water supply, gravity and pressure tanks and levels therein, valves, risers, piping, sprinkler heads and Fire Department connections, alarms, fire , booster and special service pumps, obstructions, and conditions of all other system equipment and appurtenances. All defects and/or impairments shall be noted on the report. Records shall be **readily available** to any representative of the Fire Department.

Riser Card. In addition to those records required by NFPA 25 as mentioned above, an **approved card** bearing the dates of each inspection, certificate of fitness number and signature of the certificate of fitness holder shall be posted on the premises near the main water supply control valve. (FC 901.6.2.1) **(This approved card shall not replace or supersede the detailed record of inspection).**

Notification of all defects shall be reported to the owner or their representative by the Certificate of Fitness holder. After 30 days, any of the defects that have not been corrected shall be immediately reported to the Fire Department Borough Communication Office.

Failure to make inspections, maintain records, and report defects or violations may be cause for revocation of the Certificate of Fitness and court enforcement proceedings.

5. INDIVIDUALS AUTHORIZED TO PERFORM TASKS AS SPECIFIED IN THE NEW YORK CITY FIRE CODE

1. **S-12/S-15 COF** holder - visual inspections only, proper notification and record inspection results for examination by FDNY.
 - S-12:** Water-based fire protection systems.
 - S-15:** Foam-water suppression systems and water-based fire protection systems.
2. **S-12/S-15* COF** holder employed by a site-specific building owner with the following certifications: **Refrigeration Operating Engineer (Refrigeration Q-99 or Q-01), High Pressure Operating Engineer and NYS High Pressure Operating Engineer** are permitted to perform visual inspections, test notification appliances, perform daily and weekly routine maintenance and record all inspection, testing and maintenance results for examination by FDNY.
 - *(For employees of a single or multiple properties under common ownership employed by the same building owner/management company).**
3. **Master Fire Suppression Piping Contractor (A or B) (MFSPC)** with S-12/S-15 C of F - can inspect, test, maintain and repair/replace sprinkler systems components, record maintenance, inspection and test results for examination and evaluation by FDNY.
4. **Master Plumber (MP)** with S-12/S-15 - is limited to residential (R) occupancies 30 sprinkler heads or less without a booster pump.

6. DEFINITIONS

ALARM NOTIFICATION APPLIANCE - A fire alarm system component, such as a bell, horn, speaker, light, text display or vibration device that issues an audible, tactile, and/or visual alert.

ALARM SIGNAL - A signal indicating an emergency requiring immediate action, such as a signal indicative of fire.

ANTIFREEZE SPRINKLER SYSTEM - A wet pipe sprinkler system employing automatic sprinklers that are attached to a piping system that contains an antifreeze solution and is connected to a water supply. The antifreeze solution is discharged, followed by water, immediately upon operation of sprinklers opened by heat from a fire.

AUTOMATIC BALL DRIP - An automatic drain valve horizontally installed at the low point

in the piping between the lower check valve and the Fire Department connection of automatic sprinkler systems. Water pressure from a Fire Department pumper automatically closes this valve. It automatically re-opens when pressure ceases, permitting this piping to drain and thereby preventing freezing.

CENTRAL STATION - A facility that receives alarm signals from a protected premises and retransmits or otherwise reports such alarm signals to the department.

COMBINATION STANDPIPE AND SPRINKLER SYSTEM - A system where the water piping services both 2½ in. (65 mm) outlets for fire department use and outlets for automatic sprinklers.

CONCEALED SPRINKLER - A recessed sprinkler with a cover plate.

CONTROL MODE SPECIFIC APPLICATION SPRINKLERS (CMSA) - Control mode sprinkler systems are designed to control a fire until its original fuel source is depleted or until fire-fighting activities can commence. A fire is controlled by cooling the ceiling-level air temperatures, reducing the fire's rate of heat release and pre-wetting adjacent combustibles.

CONTROL VALVE - A valve controlling flow to water-based fire protection systems. Control valves do not include hose valves, inspector's test valves, drain valves, trim valves for dry pipe, preaction and deluge valves, check valves, or relief valves.

OS & Y valve (Outside Stem and Yoke valve) is an indicating type of control valve used for fire sprinkler system.

Curb Valve is a non-indicating gate valve equipped with a cast iron extension box flushed with a sidewalk with an operating nut of 1 ¼ inch, this valve is operated using a special curb key wrench. This valve controls the municipal water supply serving the fire sprinkler system.

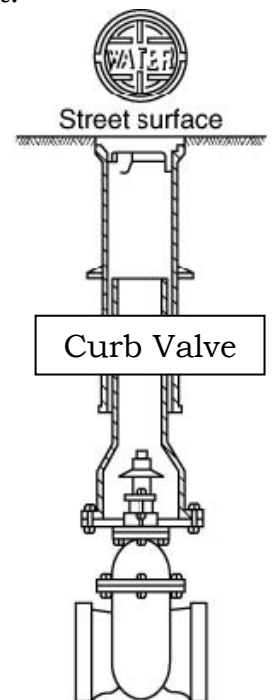

CORROSION-RESISTANT SPRINKLER - A sprinkler fabricated with corrosion resistant materials, or special coatings to be used in an atmosphere that would corrode standard sprinklers.

DEFICIENCY: A condition in which the application of the component is not within its designed limits or specifications.

CRITICAL DEFICIENCY – A deficiency that, if not corrected, can have an effect on the performance of the fire protection system.

NON CRITICAL DEFICIENCY – A deficiency that does not have an effect on the performance of the fire protection system, but correction is needed for the proper inspection, testing, and maintenance of the system(s).

DELUGE VALVE - A water supply control valve intended to be operated by actuation of an automatic detection system that is installed in the same area as the discharge devices. Each deluge valve is intended to be capable of automatic and manual operation.

DELUGE SPRINKLER SYSTEM - A sprinkler system employing open sprinklers that are attached to a piping system that is connected to a water supply through a valve that is opened by the operation of a detection system installed in the same areas as the sprinklers. When this valve opens, water flows into the piping system and discharges from all sprinklers attached.

DRY PIPE SPRINKLER SYSTEM - A sprinkler system employing automatic sprinklers that are attached to a piping system containing air or nitrogen under pressure. The release of the air or nitrogen, (as from the opening of a sprinkler) results in the water pressure opening a valve known as a dry pipe valve, resulting in the flow of water into the piping system and out of the fused sprinklers heads.

DRY SPRINKLER - A sprinkler secured in an extension nipple that has a seal at the inlet to prevent water from entering the nipple until the sprinkler operates. May be configured with an upright pendent or sidewall sprinkler.

DISCHARGE DEVICE - A device designed to discharge water or foam-water solution in a predetermined, fixed, or adjustable pattern. Examples include, but are not limited to, sprinklers, spray nozzles, and hose nozzles.

EARLY SUPPRESSION FAST RESPONSE SPRINKLER (ESFR) - A type of fast response sprinkler that is listed for its capability to provide fire suppression of specific high challenge fire hazards.

EXTRA LARGE ORIFICE SPRINKLERS (ELO) - A sprinkler head with an orifice size equal to or greater than 1". This sprinkler is used for protection of high piled storage in warehouses and less pressure is required to achieve a given discharge density.

1. Frame 2. Button 3. Gasket spring plate 4. Bulb 5. Compression Screw 6. Deflector 7. Pintle

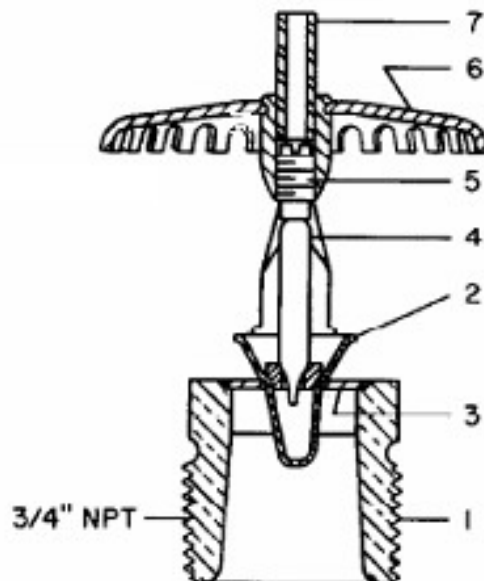

This book is provided to the public for free by the FDNY

ELO STANDARD COVERAGE UPRIGHT SPRINKLER

EXTENDED COVERAGE SPRINKLERS - A type of spray sprinkler with a maximum area of coverage of 400 square feet (20 foot by 20 foot spacing between sprinklers) for light hazard occupancies to a maximum of 144 square feet (12 foot by 12 foot spacing between sprinklers) for extra hazard occupancies.

FIRE ALARM SYSTEM - Any system, including any interconnected fire alarm sub-system, of components and circuits arranged to monitor and annunciate the status of fire alarm or supervisory signal-initiating devices.

FIRE DEPARTMENT CONNECTION - A connection, normally on the exterior of the building, through which the fire department can pump supplemental water into the sprinkler system, standpipe, or other system furnishing water for fire extinguishment to supplement existing water supplies. (Formerly known as Siamese connection.)

FIRE EXTINGUISHING SYSTEM - An approved system of devices and equipment which detects a fire and discharges an approved fire extinguishing agent onto or in the area of a fire. Such term includes automatic systems and, where such systems are authorized by this code or the Building Code, manually activated systems.

FIRE HYDRANT - A valve connection on a water supply system having one or more outlets and that is used to supply hose and fire department connections with water.

FIRE PROTECTION SYSTEM - Approved devices, equipment and systems or combinations of systems used to detect a fire, activate an alarm, extinguish or control a fire, control or manage smoke and products of a fire or any combination thereof, including fire extinguishing systems, fire alarm systems, sprinkler systems and standpipe systems.

FIRE PUMP - A pump that is a provider of liquid flow and pressure dedicated to fire protection. A fire pump is a part of a fire sprinkler system's water supply and can be powered by electric, diesel or steam. The pump intake is either connected to the public underground water supply piping or a static water source (e.g., tank, reservoir, lake). The pump provides water flow at higher pressure to the sprinkler system risers and hose standpipes. A pump used only to fill a tank is not a fire pump. The following fire pumps are required to be maintained in accordance with the NYC Fire Code:

FIRE PUMP, AUTOMATIC STANDPIPE: A fire pump located at or below street level that supplies the lower 300 feet of a standpipe system or a combined standpipe and sprinkler system.

FIRE PUMP, FOAM: A fire pump used to boost water supply pressures in a fire protection system where such system uses firefighting foam as an additive.

FIRE PUMP, LIMITED SERVICE: A fire pump with a motor rating not exceeding 30 hp and utilizing a limited service fire pump controller.

FIRE PUMP, SPECIAL SERVICE: A fire pump that is located above street level and that receives its water supply from a gravity tank or suction tank supplying water to fire sprinkler system and/or Fire Department hose outlets.

FIRE PUMP, SPRINKLER BOOSTER PUMP: A fire pump that supplies sprinkler systems only.

FIRE PUMP, WATER MIST SYSTEM: A fire pump used to boost water supply pressures in a fire protection system where such system utilizes water misting technology.

GLASS BULB SPRINKLER - A sprinkler operated by heat breaking a glass bulb filled with a non freezing liquid with diameters that vary from 3mm for quick response sprinklers to 5mm for standard response sprinklers.

HOSE VALVE - The valve to an individual hose connection.

HYDRAULIC PLACARD - A sign attached to a hydraulically calculated sprinkler system indicating the design density, required gallons per minute and pressure for the system to operate properly.

HYDRAULICALLY CALCULATED SYSTEMS - A method of sizing automatic sprinkler piping using a prescribed amount of water to be distributed over a specific area.

IMPAIRMENT - A condition where a fire protection system or unit or portion thereof is out of order, and the condition can result in the fire protection system or unit not functioning in a fire event.

IMPAIRMENT COORDINATOR - The person responsible for ensuring that proper safety precautions are taken when a fire protection system is placed out of service.

INTERMEDIATE LEVEL SPRINKLER/RACK STORAGE SPRINKLER - A sprinkler equipped with integral shields to protect the operating element from discharge from sprinklers installed at higher elevations.

LARGE ORIFICE SPRINKLER - A sprinkler head with an orifice size equal to or greater than ¾" and less than 1".

LISTED DEVICE - A fire protection component that has been tested to perform under parameters specified for its use by a nationally recognized testing agency. Underwriter's Laboratory (UL) and Factory Mutual (FM) are the two most common.

MASTER PRESSURE REDUCING VALVE - A pressure reducing valve installed to regulate pressures in an entire fire protection system and/or standpipe system zone.

MAIN DRAIN - The primary drain connection located on the system riser and also utilized as a flow test connection. These valves are typically globe pattern valves.

MICROBIOLOGICALLY INDUCED CORROSION (MIC) - Corrosion caused by the presence of microbes in the water supply that over time attack the interior of metallic piping and cause leaks, pitting, and blockages.

OUT OF SERVICE SYSTEM - A fire protection system that is not fully functional; or whose operation is impaired or is otherwise not in good working order.

OLD-STYLE/CONVENTIONAL SPRINKLER - A sprinkler that directs 40% to 60% of the water initially in a downward direction and is designed to be installed with the deflector in either the upright or pendent position.

PENDENT SPRINKLER - A sprinkler designed to be installed in such a way that the water stream is directed downward against the deflector.

PINTLE SCREWS - A visual indicating device required for sprinklers manufactured prior to 1999 identifying small orifice sprinklers and large orifice sprinklers where orifice size is different than the nominal thread size of the sprinkler head.

PIPE SCHEDULE SYSTEMS - A method of sizing piping based upon the number of sprinkler heads and the occupancy of the protected area.

PREACTION SPRINKLER SYSTEM - A sprinkler system employing automatic sprinklers that are attached to a piping system that contains air that may or may not be under pressure, with a supplemental detection system installed in the same areas as the sprinklers.

PERSONAL SUPERVISION - Supervision by the holder of a FDNY Certificate of Fitness who is required to personally present on the premises, or other proximate location acceptable to the department, while performing the duties for which the certificate is required.

PRESSURE CONTROL VALVE - A pilot operated pressure reducing valve that may be used with a fire or booster pump designed for the purpose of preventing the incoming water supply pressure from dropping below a set pressure.

PRESSURE-REDUCING VALVE - A valve designed for the purpose of reducing the downstream water pressure under both flowing (residual) and nonflowing (static) conditions.

PRESSURE RELIEF VALVE - A valve designed for the purpose of releasing excess air or water pressure from the Fire Protection Piping System.

PRESSURE TANK - A tank using air pressure to supplying water for water-based fire protection systems. Tank contents to be maintained at one third air to two thirds water.

QUICK RESPONSE SPRINKLER HEAD - A sprinkler having a fusible link with a response time index (RTI) of 50 or less.

RECESSED SPRINKLER - A sprinkler in which all or part of the body, other than the shank thread, is mounted above the ceiling.

RESIDENTIAL SPRINKLER - A type of fast response sprinkler that has been specifically tested to enhance survivability in the room of fire origin and listed for use in dwelling units.

RESPONSE TIME INDEX (RTI) - A measurement of the thermal sensitivity of a sprinkler head expressed in (meters-seconds) $1/2$.

SPRINKLER IDENTIFICATION NUMBER (SIN) - Sprinklers manufactured after Jan. 1, 2000 are required to be marked to identify performance characteristics.

SUPERVISORY SIGNAL - A signal indicating the need for action in connection with the supervision of guard tours, fire extinguishing systems or equipment, fire alarm systems or the maintenance features of related systems.

SIDEWALL SPRINKLER - A sprinkler having special deflectors that are designed to discharge most of the water away from the nearby wall.

SMALL ORIFICE SPRINKLERS - A sprinkler head with an orifice size smaller than $1/2$ ".

SOLDER LINK SPRINKLER - A sprinkler operated by the melting of a metal link, they vary in size and configuration for quick response and standard response sprinklers. The smaller the size of the link, the faster the sprinkler operates.

SPRAY SPRINKLER - A type of sprinkler listed for its capability to provide fire control for a wide range of fire hazards. The most commonly used sprinkler since 1953.

SPRINKLER SYSTEM - A fire extinguishing system, other than a mist fire extinguishing system that utilizes water as the extinguishing agent.

STANDARD RESPONSE SPRINKLER HEAD - A sprinkler having a fusible link with a response time index (RTI) of 80 or more.

SUPERVISORY SIGNAL-INITIATING DEVICE - An initiating device, such as a valve supervisory switch, water level indicator, or low-air pressure switch on a dry-pipe or pre-action sprinkler system, that triggers a supervisory signal.

AUTOMATIC PRESSURE MAINTENANCE DEVICE - Maintains pneumatic pressure on the piping system set to specific limits by controlling a plant air system, a single air compressor, or a nitrogen supply.

TESTING - A procedure used to determine the status of a system as intended by conducting periodic physical checks on water based fire protection systems such as waterflow tests, fire pump tests, alarm tests, and trip tests of dry pipe, deluge, or preaction valves. These tests follow up on the original acceptance test at intervals specified in the appropriate chapter of NFPA #25, 2011 edition.

UPRIGHT SPRINKLER - A sprinkler designed to be installed in such a way that the water spray is directed upwards against the deflector.

WATER SPRAY - Water in a form having a predetermined pattern, particle size, velocity, and density discharge from specially designed nozzles or devices.

WATER SUPPLY - A source of water that provides the flows [gal/min (L/min)] and pressures [psi (bar)] required by the water-based fire protection system.

WET PIPE SPRINKLER SYSTEM - A sprinkler system employing automatic sprinklers attached to a piping system containing water and connected to a water supply so that water discharges immediately from sprinklers opened by heat from a fire.

WATER SPRAY FIXED SYSTEM - A special fixed pipe system connected to a reliable fire protection water supply and equipped with water spray nozzles for specific water discharge and distribution over the surface or area to be protected. The piping system is connected to the water supply through an automatically or manually actuated valve that initiates the flow of water. An automatic valve is actuated by operation of automatic detection or manual release equipment installed in the same areas as the water spray nozzles. (In special cases, the automatic detection system may also be located in another area.)

WATER TANK - A tank supplying water for water-based fire protection systems.

7. SYSTEM TYPES

7.1 AUTOMATIC WET SPRINKLER SYSTEMS

An automatic wet sprinkler system is an effective fire suppression system. This system discharges water to a localized area that is subject to fire. The sprinkler system is designed to extinguish the fire entirely, or to prevent the spread of the fire. An automatic sprinkler system consists of a series of pipes at or near the ceiling in a building. The sprinkler system is fitted with automatic devices designed to release water on a fire. These devices are called sprinkler heads. The sprinkler heads are normally closed by a disc or cap. This cap is held in place by a heat sensitive releasing element. A rise in temperature to a predetermined level causes the sprinkler head to open. Water is then discharged in the form of spray. When the sprinkler heads open they are said to have fused. The sprinkler heads are fitted at standard intervals on the piping. If more than one head opens, the area sprayed by each overlaps that of the sprinkler head next to it.

Sprinkler systems are required by law in various occupancies. They also may be installed voluntarily by the owner of the building. The sprinklers are installed to protect the building and its residents. The installation of sprinklers has a major effect in reducing fire losses. About 96% of the fires are extinguished or controlled when sprinklers are installed. The 4% failure was due to a variety of causes including defective piping, closed supply valves, frozen water lines, improper maintenance, and blocked water supply piping.

Automatic sprinklers are very effective for preservation of life and property by discharging water to the burning area. Automatic sprinklers also reduce interference with visibility for fire fighting due to smoke. The downward force of the water sprayed from sprinklers lowers the smoke level in the room. The sprinklers also serve to cool the smoke. This makes it possible for persons to remain in the area much longer than they could if the room were without sprinklers.

Most standard sprinkler systems have devices that automatically sound an alarm when a sprinkler head discharges water. This alarm is an audible signal at the premise. In many cases they transmit an alarm to a remote location, such as an approved central station company. The central station company monitors the entire fire protection system for water discharge and problems with the equipment. When water discharge is identified, in addition to other actions, the central station company is required to notify the FDNY dispatch. This notification allows the Fire Department to gain control of a fire as quickly as possible. Water is rarely discharged accidentally from a properly maintained sprinkler system.

The most common installation is a wet pipe system. This system has water in the piping at all times. The owner is to ensure that all areas of buildings with water-filled piping are maintained at a minimum of 40 degrees Fahrenheit and are protected from freezing. A example of a typical wet pipe system is shown in the picture on the next page:

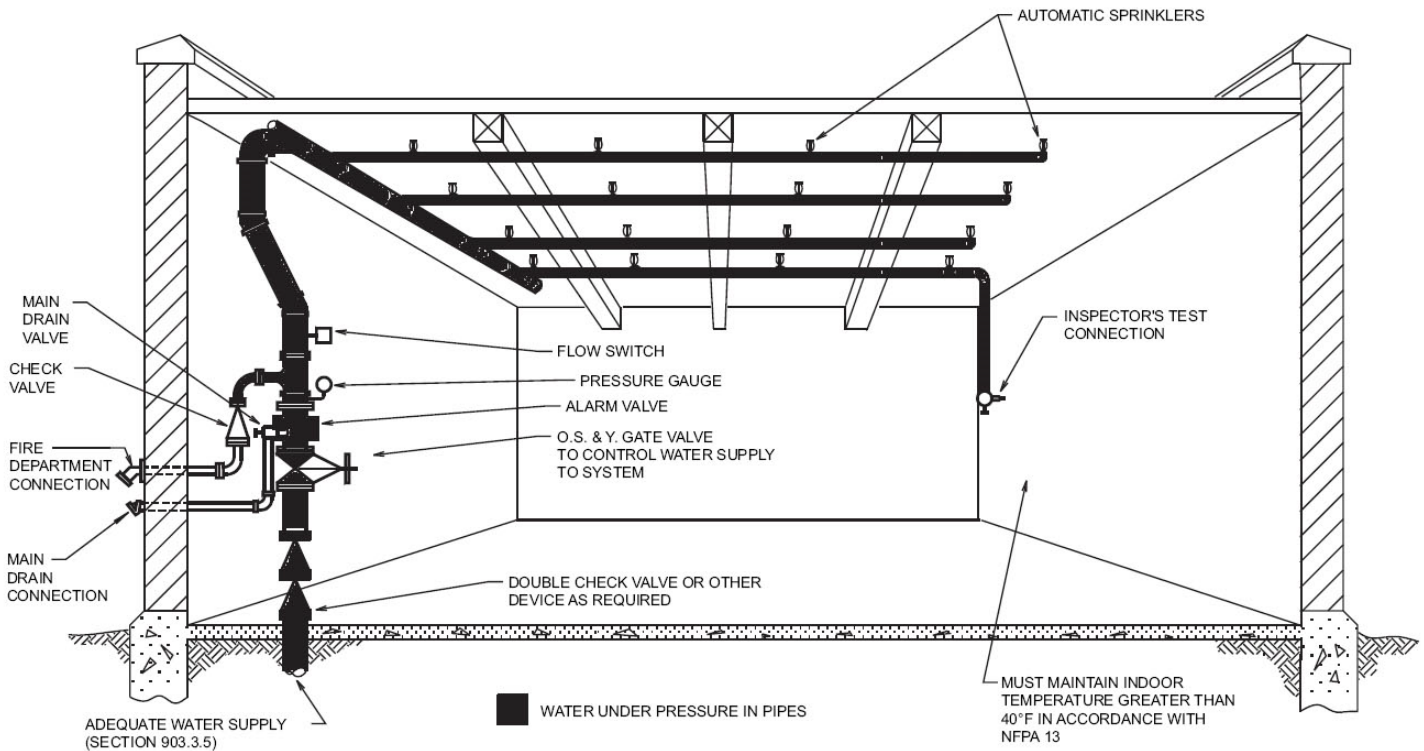

A TYPICAL WET PIPE SYSTEM

Where temperatures drop below freezing, the ordinary wet pipe system cannot be used.

Antifreeze Sprinkler System - A wet pipe sprinkler system employing automatic sprinklers that are attached to a piping system that contains an antifreeze solution and that are connected to a water supply. The antifreeze solution is discharged, followed by water, immediately upon operation of sprinklers opened by heat from a fire. Antifreeze **sprinkler systems** are costly and are difficult to maintain. Antifreeze is usually used for small unheated areas. Antifreeze **sprinkler systems** may be used only in accordance with applicable local health regulations.

The freezing point of solutions in antifreeze shall be tested annually by measuring the specific gravity with a hydrometer or refractometer and adjusting the solutions if necessary. Annual testing must be performed in accordance with NFPA 25 2011.

Existing Cold Weather Valves - An automatic sprinkler system should not be shut off and drained to avoid freezing during cold weather. However, parts of the sprinkler system may be shut down. Permission must be obtained from the local fire house. Permission may be given to shut off a maximum of 10 sprinkler heads on a wet pipe system. These shutoff valves are commonly referred to as cold weather valves. These valves are no longer permitted to be installed.

7.2 AUTOMATIC DRY SPRINKLER SYSTEMS

Dry Pipe Sprinkler System. A sprinkler system employing automatic sprinklers that are attached to a piping system containing air or nitrogen under pressure, the release of which (as from the opening of a sprinkler) permits the water pressure to open a valve known as a dry pipe valve, and the water then flows into the piping system and out the opened sprinklers.

Dry Pipe Sprinkler Systems are installed where it is impractical to install a wet pipe system since the protected area cannot be heated to prevent freezing conditions. In most cases the air pressure in the piping is controlled automatically by an air maintenance device. When a sprinkler head is opened by the heat from a fire, the air pressure is reduced in the piping. The drop in air pressure causes a special dry pipe valve to open. When the clapper has opened the valve is said to have tripped. A supervisory device signals when the valve has opened that will automatically sound an alarm. This alarm is an audible signal at the premise and in many cases it will transmit an alarm to a remote location, such as an approved central station company. The central station company monitors the entire fire protection system for water discharge and problems with the equipment. When water discharge is identified, the central station company is required to notify the FDNY dispatch. This notification allows the Fire Department to gain control of a fire as quickly as possible. Water is rarely discharged accidentally from a properly maintained sprinkler system.

Sometimes a combination of a wet pipe and a dry pipe system may be used when a part of the building cannot be heated.

A TYPICAL DRY PIPE SYSTEM

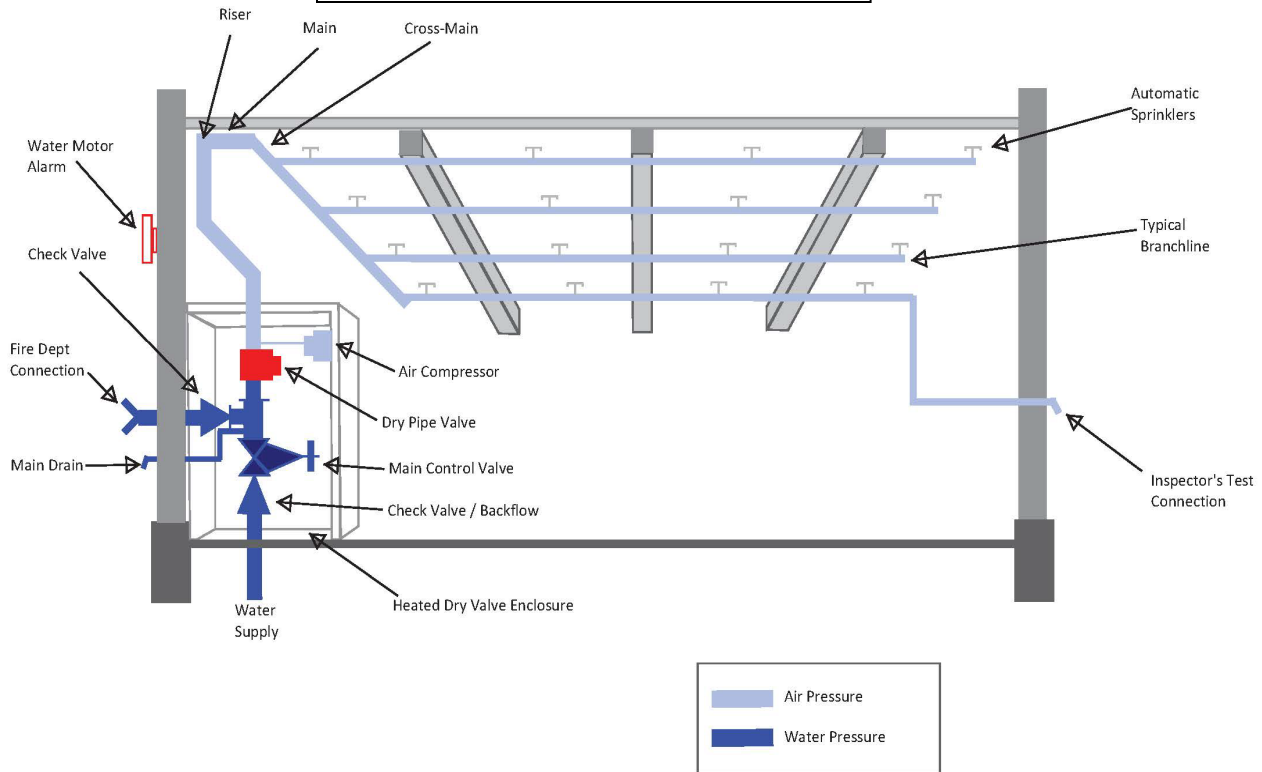

A Typical Clapper Type Dry Valve

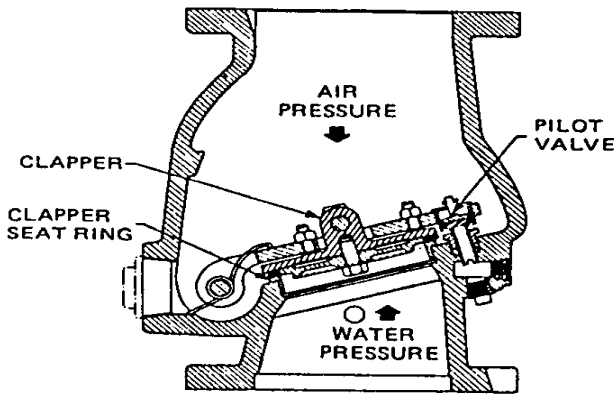

Higher than normal water pressure and/or water hammer, may cause the dry valve to trip accidentally. Water hammer is a condition where a sudden increase in pressure may cause the valve to trip. To reduce this danger air pressure is usually kept well above the normal trip point. The air pressure is usually set at 15 to 20 psi (pounds per square inch) above the normal trip level. Some valves are specially designed for low pressures. In all cases the manufacturer's instructions regarding pressures to be maintained shall be followed.

Quick Opening Devices - In a dry pipe system there is a delay between the opening of a sprinkler and the discharge of water. This delay may allow the fire to spread and more sprinkler heads to open. The delay is due to the time required for the air leave the sprinkler piping. This difficulty may be partly overcome by the installation of quick opening devices. Quick opening devices when employed must be in operation at all times.

Two devices are used to reduce the time needed to open the clapper and allow water into the system. These devices are an accelerator and an exhauster. They are both automatically activated when a drop of 2 psi in air pressure is detected in the system. They quickly change the water and air pressure balance in the system. This change trips the dry pipe valve allowing the water to force its way through the sprinkler piping in less time. The failure of an accelerator or exhauster to operate will increase the normal tripping of a dry pipe valve.

7.3 PREACTION SPRINKLER SYSTEMS

Preaction systems are designed for situations where there is danger of serious water damage. Water damage is usually caused by damaged sprinklers or broken piping. Under normal conditions there is no water in the piping. The air in the piping may or may not be under pressure. A preaction valve prevents the water from entering the system. The valve is automatically opened when a fire detection system discovers that there is a fire or smoke condition. The preaction valve is tripped by the fire detection system before any of the sprinkler heads open. A supervisory device signals when the valve is opened. The pre-action valve can also be operated manually.

The preaction system has several advantages over a dry pipe system. The preaction valve opens sooner because the fire detectors react to heat changes faster than sprinkler heads. Fire and water damage may be decreased because water is sprayed on the fire more quickly the alarm signal is given as soon as the preaction valve is opened.

Heat responsive devices are commonly used to trip pre-action valves. These devices are also used to activate alarm and supervisory systems. There are three main devices used to trip pre-action valves: 1) devices designed to operate at a fixed temperature; 2) devices designed to operate when the temperature in the room increases a set amount in a given time period (rate-of-rise), and 3) devices combining fixed temperature and rate of rise devices. Other ways to activate a preaction valve are smoke detectors, gas detecting systems, hydraulic, electric, manual release, and automatic signals from other safety systems.

A supervisory device signals when the valve has opened that will automatically sound an alarm. This alarm is an audible signal at the premise and in many cases it will transmit an alarm to a remote location, such as an approved central station company. The central station company monitors the entire fire protection system for water discharge and problems with the equipment. When water discharge is identified, the central station company is required to notify the FDNY dispatch.

Preaction System with a Recycling Feature - A special kind of preaction system is a recycling system for controlling sprinklers. This system shuts off the water when the fire has been put out or the heat drops. If the fire rekindles or the heat rises sharply, water is discharged again. The system continues cycling on and off as long as the fire persists.

Combined Dry Pipe and Preaction Systems - These systems have the basic features of both types of systems. The piping system contains air under pressure. A heat detecting device opens the water control valve and a quick opening device. The system then fills

with water and operates as a wet pipe system. If the heat detecting system fails, the system will operate as a standard dry pipe system.

7.4 DELUGE SPRINKLER SYSTEMS

A deluge sprinkler system is equipped with open sprinkler heads designed to wet down an entire area involved in a fire. This system is needed when there is danger of a fire rapidly spreading throughout the building. The deluge system will slow down the spread of the fire. Deluge systems are suitable for hazardous occupancies. This includes buildings in which flammable liquids or other hazardous materials are handled or stored.

The sprinkler heads in the deluge system are open at all times. Under normal conditions there is no water in the piping. The air in the piping is not under pressure. A closed control valve prevents water from flowing into the system. A fire detection device automatically opens the control valve when a fire is identified. A supervisory device signals when the valve is opened. When the valve is opened water flows into the system. The water is then discharged out all of the sprinkler heads. The water control valve may also be opened manually.

A supervisory device signals when the valve has opened that will automatically sound an alarm. This alarm is an audible signal at the premise and in many cases it will transmit an alarm to a remote location, such as an approved central station company. The central station company monitors the entire fire protection system for water discharge and problems with the equipment. When water discharge is identified, the central station company is required to notify the FDNY dispatch.

7.5 NON-AUTOMATIC DRY SPRINKLER SYSTEMS

In this type of system all pipes are normally dry. Water is supplied when needed by pumping water into the system through the Fire Department connection. Some of these systems are supplied by manual operation of a water control valve and may be equipped with sprinklers with or without fusible links.

There are several non-automatic systems: **1)** Perforated pipe systems - a single line of piping drilled at intervals for water discharge. These systems are usually found in basements or other areas difficult to reach in fire fighting operations. **2)** Open fixed spray nozzles for transformer vaults or other hazardous areas; **3)** exterior exposure sprinklers (or window sprinklers) use open sprinkler heads to form an external water curtain on the walls of a building, and **4)** Foam supply systems are used for the protection of special hazardous occupancies.

7.6 GARBAGE COMPACTOR SPRINKLER SYSTEMS

Waste compactors are usually found in tall multiple dwelling complexes such as apartment buildings. They are used to reduce the trash buildup in a building. They consist of a tall chute with an opening at each floor. These opening are used for trash disposal. Occupants of the buildings take their trash and throw it through the opening and down the chute. The trash piles up at the bottom of the chute where a device

regularly crushes the trash into smaller blocks of trash. The blocks of trash are then removed and taken to a garbage dump. The compactor may be located indoors or outdoors.

The build-up of trash in the compactor chute is a fire hazard. Fires may be started in several ways, for example, by a smoldering cigarette thrown into the compactor chute. Sprinkler systems must be installed to put out fires that start in the compactor chute. Any of the standard water supply sources may be used to supply the compactor sprinkler system. For example, gravity tanks, fire pumps and pressure tanks are all used as water supply sources. Fire doors shall be installed in the chute to allow firefighter access to burning trash.

The Certificate of Fitness holder shall know the location of all sprinkler heads, control valves, supply lines and compactor rooms. A sketch of the entire compactor sprinkler system shall be drawn by the Certificate of Fitness holder. This sketch shall be posted in the compactor room in a frame under glass. The sketch shall be made available to any representatives from the Fire Department. The Certificate of Fitness holder may be questioned about this sketch by inspectors from the Fire Department inspectors during routine inspections. A sign indicating the location of all control valves shall be kept in the compactor room. This sign is shall be displayed with the sketch in the compactor room. All control valves in the sprinkler system shall be labeled. The label is to show the purpose of the valve. Additionally, the labels shall be attached to the yoke of the valves. All indicating valves in the compactor sprinkler system shall be sealed open.

A minimum of 6 extra sprinkler heads with the appropriate wrenches shall be available to replace any opened or damaged sprinkler heads. Opened or damaged sprinkler heads shall be replaced immediately. A garden hose connected to a water supply shall be kept in the compactor room. This hose may be used to put out small fires or smoldering material in the compactor room.

The Certificate of Fitness holder shall conduct an inspection of the entire sprinkler system at least once a month. Special attention should be given to the condition of the sprinkler heads in the compactor chute and the compactor room. Any defects or violations shall be recorded in a detailed inspection report. All inspections are recorded on a card that shall be kept near the main control valve. The Certificate of Fitness holder shall sign and date the card each time an inspection is made. If any minor defects in the system are discovered they shall be reported to the owner of the building. If repairs are not made within 30 days the Certificate of Fitness Holder must notify the Bureau of Fire Prevention. If any major defects are discovered they shall be reported to the FDNY Dispatcher, the owner of the building, and the Bureau of Fire Prevention. Major defects shall be repaired immediately.

When a fire is discovered in the compactor the Certificate of Fitness holder should notify the local fire house immediately. He/she should not attempt to enter the compactor chute to put out the fire.

8. WATER SUPPLIES FOR SPRINKLER SYSTEMS

Sprinklers may be supplied from one or a combination of sources. For example, they may be supplied by public mains, gravity tanks, pressure tanks, fire pumps, reservoirs, rivers, or lakes. A single water supply would appear to be all that is needed to supply a sprinkler fire protection system. This assumes that there is enough water at an acceptable pressure. However, a single supply may be out of service (for maintenance or repair) during a fire emergency or it may be disabled during fire or before the fire is fully extinguished. Additionally, the water supply may fall below normal pressure or volume during an emergency. These are just a few reasons why it is good to have a secondary water supply.

In some cases it is required by law to have a secondary water supply source. Whether a second source is needed depends on several factors. These factors include the strength and reliability of the primary supply, the value of the property, the height, area, occupancy classification and design of the building.

When a sprinkler system is supplied from a public water main, the entire system shall be shut down by closing a non-indicating type control valve. This valve is located between the building and the water main in a box that is recessed into the sidewalk. The location of the box is found by reading a sign on the building or on a post nearby. The sign might read **“Shutoff for Sprinkler System Located 6 Feet from This Sign”**, or it may have similar instructions. A special key will be required to operate this valve.

8.1 CONTROL VALVES

Gate valves of the non-indicating type are provided in water distribution systems, this type of valve is commonly known as curb valve. Gate valves allow the sprinkler system to be shut off for repairs or maintenance. Such valves are normally a non-rising stem type. They are operated using a special key wrench. A valve box is located over the valve to keep dirt from the valve. The valve box also provides a convenient access point for the valve wrench to the valve nut. A complete record should be made for each valve in the system. This record should include the exact location, the date it was installed, the make, the direction of opening, number of turns to open, and any maintenance that was performed.

The control valve for the building may also be on the outside wall or attached to an upright post, known as a post indicator valve (PIV), see image on right. The building or section of the building controlled by the valve is usually marked on the post. The position of this valve (open or closed) is shown through a telltale opening in the post. On some posts, a padlock must first be opened to release the operating wrench or wheel handle.

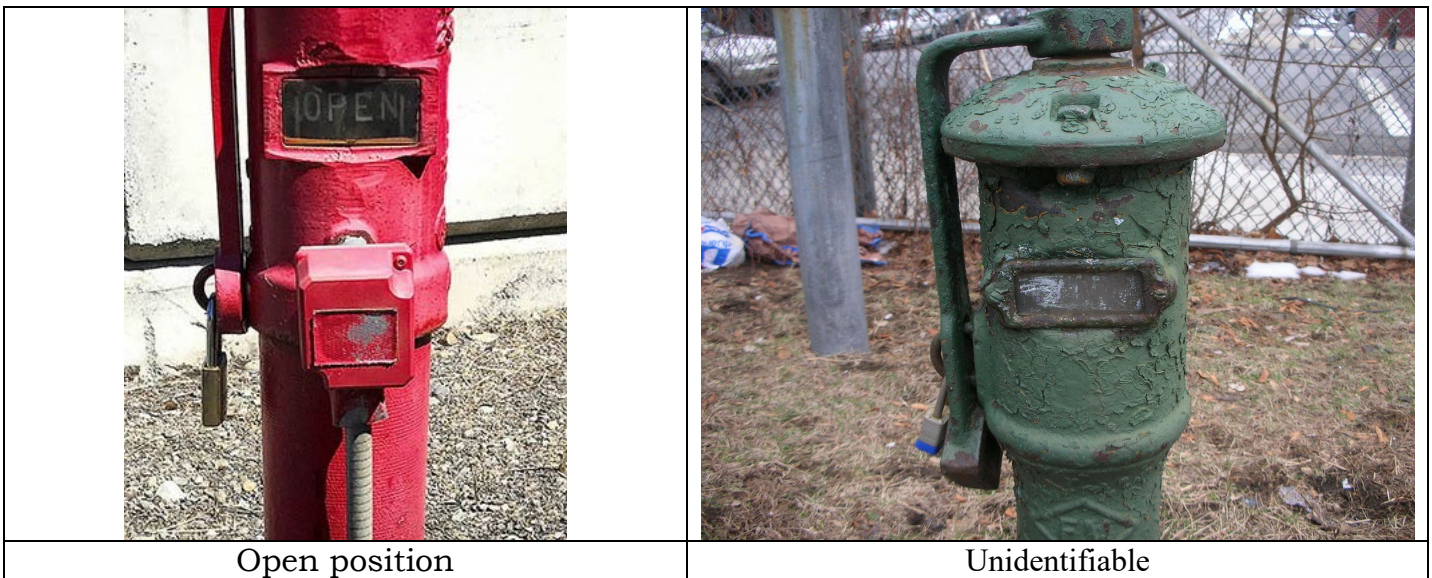

The main water supply for sprinklers may also be controlled by an OS&Y valve (Outside Stem and Yolk valve). The valves are found just inside the building wall on the main riser, or outside in protected pits. It is easy to tell at a glance if the valve is open or shut. When the stem is all the way out the valve is open. When the stem is all the way in the valve is closed. Approved Indicator Valves use a flag that shows the valve position and the valves commonly are used to control the water supply for individual floors in a building. Indication Control valves are also installed to shut off certain sections of an individual floor. Being able to shutoff parts of a building allows the Fire Department to have greater control over the sprinkler system. When a fire is under control in an area the OS&Y valve can be closed to prevent any further water damage.

Sometimes repairs must be made to the sprinkler system. When this occurs the indicating control valves are used to close the water supply to only those sections being repaired. This is good safeguard since the rest of the sprinkler system does not have to be shut down.

8.2 SPRINKLER SYSTEM CONTROL VALVE SIGNAGE

A sign identifying the location of the sidewalk box housing the sprinkler system control valve shall be conspicuously posted on the exterior wall of the building directly opposite the sidewalk box. Such sign shall have red letters 1 inch in height on a white background and read: "Sprinkler System Shutoff Valve (*indicate distance*) feet opposite this sign" or other approved design.

8.3 FIRE DEPARTMENT CONNECTIONS

Normally a sprinkler system is connected to an automatic water supply source. Auxiliary sources of water are supplied through Fire Department connections at the building. Fire Department connections are a standard part of most sprinkler systems. When responding to an alarm most Fire Departments supply water to the standpipe system first. The standpipe system supplies water to the fire hoses to be used within the

building. Water is then supplied to the sprinkler system through its own Fire Department connection. Care should be taken that standpipe and the sprinkler connections are properly marked because the connections look the same. The exact purpose of each Fire Department connection should be shown nearby or on the Fire Department connection itself. The New York City Building Code requires Fire Department Connection to be color coded. The Fire Department connection caps on an automatic sprinkler system shall be painted green. The Fire Department connection caps on a standpipe system shall be painted red. The Fire Department connection caps on a combined standpipe/sprinkler system shall be painted yellow. The **ENTIRE** Fire Department connection to non-automatic sprinkler system shall be painted silver. Local Law 58/2009 requires color coding of fire standpipe and fire sprinkler systems to have the risers, cross connections to the water supply piping painted red (for sprinklers BC 903.6 and for standpipe BC 905.11) .

Fire Department connections must always be accessible. A working space of not less than 36 inches in width, 36 inches in depth and 78 inches in height shall be provided and maintained in front of and around wall-mounted and free-standing fire department connections, except as otherwise required or approved. (FC 912.3) Each connection shall be fitted with a lower check valve. The lower check valve prevents the backflow of the private water supply into the Fire Department connection. The figure below shows the main features of a Fire Department connection.

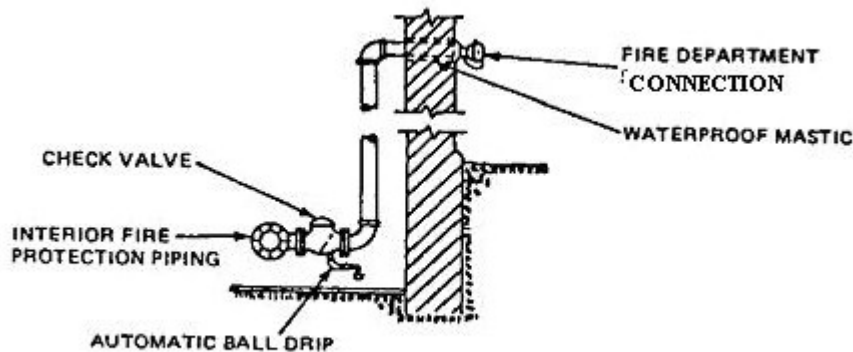

FIRE DEPARTMENT CONNECTION

The automatic ball drip device between the lower check valve and the outside Fire Department connection **shall be installed in the horizontal position**. This ball drip device makes sure that the Fire Department connection is not blocked by water which has frozen within the piping. If water freezes in the Fire Department connection the system will be considered impaired.

8.4 Gravity Tanks

Gravity tanks of adequate capacity and elevation make a good primary supply and may be acceptable as a single supply. A gravity tank may be located on the top of a building or on a tall tower. The water in the tank is distributed throughout the sprinkler system because of the pull of gravity.

8.5 Pressure Tanks

Pressure tanks have several possible uses in automatic sprinkler and standpipe systems. The tank is normally kept at two-thirds full of water and one third full of air. The air pressure in the tank shall be maintained at or above 75 psi. Air for pressure tanks is supplied by air compressors. Because the water is always under pressure it can be forcefully distributed throughout the sprinkler and/or standpipe system. An important limitation is the small amount of water that can be stored in such tanks. Where a small pressure tank is accepted as the water supply, the system is called a Limited Supply System. Pressure tanks are often used in situations where an adequate amount of water can be supplied by a public or private source but the water pressure is not adequate. The pressure tank gives a strong starting pressure for the first sprinklers or hose valves that open. The flow from the tank may be used while the automatic fire pumps begin to increase the water supply pressure. Pressure tanks are often used in tall buildings that need extra water pressure to supply the highest line of sprinkler heads or hose valves. The pressure tank supplies these devices until the Fire Department begins pumping water into the system. Pressure tanks are equipped with settling basin at the bottom of the tank to prevent sediment and other foreign materials from entering the sprinkler system.

8.6 Fire Pumps

Fire pumps can be used to boost water pressure and volume for water based fire protection systems. They may be used in combination with municipal water supply, suction tanks and gravity tanks to supply sprinkler system. Fire pumps are designed to take the water from a supply source and then discharge the water into the fire protection system under pressure. The amount of pressure with which the water is discharged from the pump is called the total head. The total head is measured in pounds per square inch (psi). The higher the psi rating of the pump the greater the pressure with which the water can be discharged. Fire Pumps shall be sized to satisfy the hydraulic requirements of the water based fire protection system.

Automatic fire pumps must have their suction “under a positive head” to draw water from a supply source. Under positive head simply means that the water supplying the pump must be fed into the fire pump under pressure. This can be achieved by connecting the fire pump to a suction tank. Water is forced into the pump because of gravity.

9. WATER-FLOW ALARMS AND SPRINKLER SYSTEM SUPERVISION

Sprinkler systems should have devices and equipment for signaling when water flows through risers or mains supplying the systems. The flow may be due to fire, leakage, or accidental rupture of the piping. It is important that prompt action is taken when waterflow is signaled by these devices.

9.1 FUNCTIONS OF ALARMS AND SUPERVISORY SIGNALS

A sprinkler system with a water flow alarm serves two functions: 1) It is an effective fire extinguishing system, and 2) It is an automatic fire alarm. An alarm is signaled soon

after a sprinkler head has opened. This is important since it allows the occupants' time to leave the building. It also signals that the Fire Department should be summoned.

Waterflow alarms and fire alarms give warning of the actual occurrence of a fire. They also signal when water flows through the system due to broken pipes. Alarms alert occupants and summon the Fire Department. Any signal, whether water-flow or supervisory, may be used to sound an audible local sprinkler alarm. It may also send a signal to the central station company. In systems equipped with central monitored connections the central station company shall be notified when any control valves are closed for maintenance and repair. This practice reduces false alarms.

Sprinkler systems are required to have an approved water motor gong or an electric bell, horn, or siren on the outside of the building. An electric bell or other audible signal device may also be located inside the building. Water operated devices must be located near the alarm valve, dry pipe valve, or other water control valves in order to avoid long runs of connecting pipe.

9.2 DEVICES AND EQUIPMENT SUPERVISED

Sprinkler system supervision is commonly provided for several purposes. They are used to supervise:

- 1) water supply control valves,
- 2) low water level in water supply tanks,
- 3) low temperature in water supply tanks or ground level reservoirs,
- 4) high or low water level in pressure tanks,
- 5) high or low air pressure in pressure tanks,
- 6) high or low air pressure in dry pipe or pre-action sprinkler systems,
- 7) failure of electric power supply or phase reversal to fire pumps and,
- 8) automatic operation of electric fire pumps.

Waterflow Alarm Valves - The basic design of most water-flow alarm valves is that of a check valve which lifts from its seat when water flows into a sprinkler system. This alarm then starts an audible signal to alert the occupants in the building that the sprinkler system has been activated.

Vane type waterflow - Switches have a paddle inserted inside the main supply piping perpendicular to the direction of flow. Upon waterflow, the paddle switch transmits an alarm. Vane type water-flow switches shall not be installed to monitor waterflow in dry pipe or pre-action sprinkler systems.

Pressure type waterflow - Switches mounted on a trim line. Upon waterflow, the switch transmits an alarm. Pressure type waterflow switches are commonly used to monitor water flow in dry pipe and pre-action systems.

Alarm Retarding Devices - An alarm check valve that is exposed to changing water supply pressure needs an alarm retarding device. This is required to prevent false alarms when the check valve clapper is lifted from its seat by a temporary pressure

surge. Vane type water flow switches sensitivity can also be adjusted to changing water pressures.

10. SYSTEM COMPONENTS

10.1 SPRINKLER HEADS

Sprinkler heads are made of metal. They are screwed into the piping at standard intervals. The water is prevented from leaving the sprinkler head by an arrangement of levers and links. The levers and links are soldered together on the sprinkler head. The solder is a metal alloy with a fixed melting point. Other types of sprinkler heads use a glass bulb which expands and breaks under heat. The sprinkler head is factory tested to withstand at least 400 psi without injury or leakage. If properly installed, there is little danger of the sprinkler operating unless it is damaged.

There are over 50,000 different variations of sprinkler heads. Sprinklers manufactured after 1/1/2000 are required to have a Sprinkler Identification Number (SIN). Sprinkler heads manufactured prior shall be replaced as required with sprinkler heads of similar characteristics such as orifice size, temperature rating, and deflector orientation.

Certain sprinkler heads have been recalled, one of which is called the "cycling sprinkler". All sprinkler heads listed for recall and replacement can be found at www.cpsc.gov.



More recalled sprinkler heads



Some sprinkler heads are designed to be used in special situations. Sprinkler heads exposed to corrosive conditions are often covered with a protective coat of wax, or lead. Corrosive vapors are likely to make automatic sprinklers inoperative or slow down the speed of operation. They can also seriously block the spray nozzles in the sprinkler heads. They can damage, weaken or destroy the delicate parts of the sprinkler heads. In most cases such corrosive action takes place over a long time. For this reason the sprinkler heads must be carefully watched for signs of corrosion. Care should be taken to make sure that the protective coating is not damaged when handling or replacing the heads. A typical fusible link type sprinkler head is shown as the graph.

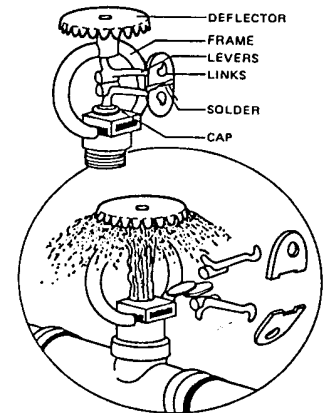

A Typical Sprinkler

10.1.1 Four Types of Sprinkler Heads



1. Pendent sprinkler heads

Pendent sprinkler is designed to be installed in such a way that the water stream is directed downward against the deflector. This kind of sprinkler hangs from above-ceiling pipes and distributes water in a domed or conical pattern using a convex deflector. In other words, these sprinklers are installed with the deflector below the frame so water flows downward from the opening, striking the deflector to create an umbrella pattern. Unlike concealed pendent sprinklers which hide behind decorative plates, the head of a traditional pendent fire sprinkler remains visible after installation. These sprinkler heads are the most common heads for sprinkler systems. When these heads are activated, a stream of water is sent downward onto the deflector, which disperses the water throughout the room.

pendent sprinkler head	Installed pendent sprinkler head	Pendent sprinkler head water spray
		

2. Upright sprinkler heads

Upright fire sprinklers spray water upward to a concave deflector, producing a dome-shaped spray pattern. They install deflector-up to cover specific areas and to prevent ice and debris from collecting in the head. Upright sprinklers are installed where obstructions interfere with coverage and in dry-pipe systems facing freezing temperatures.

Upright sprinkler head	Installed upright sprinkler head	Upright sprinkler head water spray
		

3. Sidewall sprinkler heads

Sidewall fire sprinklers install along walls or beneath beams where ceiling piping is unavailable, or where aesthetic concerns or obstructions weigh against the use of other sprinkler types. Most are designed to protect areas that are tight on space like small rooms, closets, or hallways. Sidewall sprinkler head can spray in a half-circle pattern, which will cover the entire area.



Horizontal sidewall sprinklers should only be installed below smooth, flat, horizontal ceilings in accordance with their listings, approvals, and NFPA guidelines. They are used in hotels, restaurants, churches, and a range of commercial structures.

Sidewall sprinkler head	Installed sidewall sprinkler head	Sidewall sprinkler head water spray
		

4. Concealed sprinkler heads

Concealed models install in walls or ceilings and fully cover a pendent or sidewall sprinkler head using a concealed fire sprinkler cover plate. This heat-sensitive plate detaches at temperatures roughly 20 degrees lower than the fire sprinkler head, allowing the concealed sprinkler's deflector to drop and the head to activate.

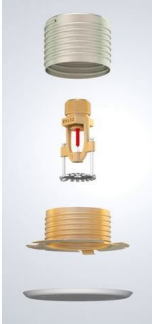
The look of fire sprinkler cover plates varies enormously from manufacturer to manufacturer. While most sprinkler heads are available in white, chrome, black, or brass, cover plates are available in a wider range of finishes, including wood-pattern, metallic, and, in some cases, custom-painted versions. These fire sprinkler cover plates should never be painted and must always be replaced with the manufacturer's approved plate

Concealed sprinkler head	Installed concealed sprinkler head
	

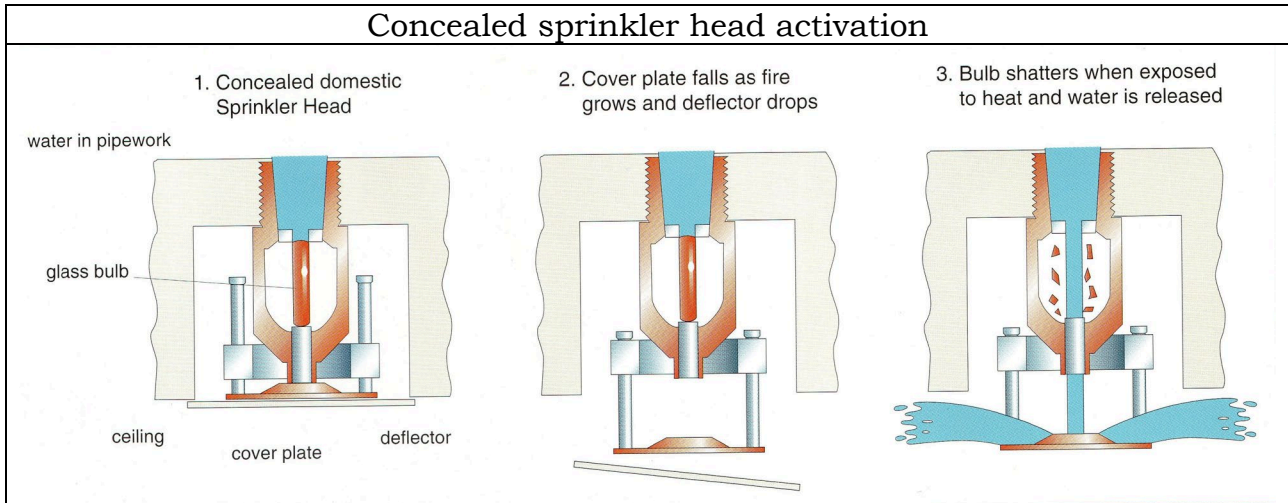

10.1.2 Spray Pattern of Sprinkler Heads

The best way to put out a fire is to spray the water from the sprinkler head downward and horizontally. The spray pattern will also prevent the spread of the fire. The force of the water against the deflector creates a heavy spray which is directed outward and downward. The shape of the deflector determines the spray pattern of the water discharged from the sprinkler head. Usually, this is an umbrella shaped spray pattern. At a distance of 4 feet below the deflector, the spray covers a circular area having a diameter of approximately 16 feet when the sprinkler is discharging 15 gpm.

Sprinkler Spray patterns must not be obstructed by building components or storage.

pendent sprinkler water spray pattern	Upright sprinkler head water spray pattern	Sidewall sprinkler head water spray pattern

10.1.3 Standard Response and Quick Response Heads

Standard Response Sprinkler Heads

A standard response sprinkler head is a sprinkler having a fusible link or glass bulb with a response time index (RTI) of 80 or more. Standard response sprinkler heads are typically found in warehouses, factories and other commercial or industrial buildings.

Quick Response Sprinkler Heads

A quick response sprinkler head is a sprinkler having a fusible link or glass bulb with a response time index (RTI) of 50 or less. Quick response fire sprinkler heads are typically found in light hazard occupancies (e.g. office buildings, schools, health care facilities, assisted living facilities, and residential occupancies etc.). The use of quick response sprinkler heads may reduce or eliminate the requirements for smoke detection in certain light hazard occupancies. Quick response sprinklers may also be used in storage applications and are called ESFR (Early Suppression, Fast Response) sprinklers.

Differences Between Standard and Quick Response Sprinkler Heads

Quick response sprinklers got their name from their slightly faster response time when compared to standard response sprinklers. Their only physical difference is the bulb size. The standard response sprinkler has a 5 mm glass bulb and the quick response sprinkler has a 3 mm glass bulb. The smaller bulb has a lower response time index (RTI).

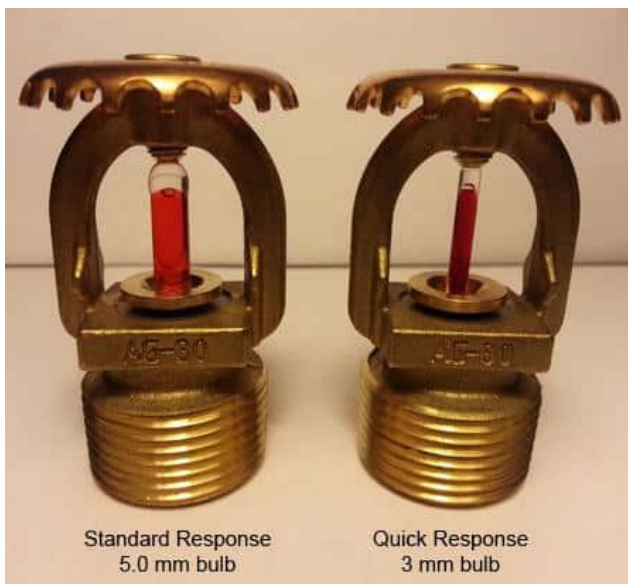

10.1.4 Systems Using Large Drop Sprinkler Heads

Large drop sprinkler heads are special sprinklers designed to discharge large drops of water from the head. These sprinkler heads are used to break through the strong updrafts of high challenge fires.

10.2 TEMPERATURE RATINGS CLASSIFICATIONS AND COLOR CODING (THIS CHART WILL BE PROVIDED WHEN TAKING THIS TEST)

Sprinklers shall have their frame arms, deflector, coating material, or liquid bulb colored in according the following table:

TEMPERATURE RATINGS CLASSIFICATIONS AND COLOR CODING*						
Maximum Ceiling Temperature		Temperature Rating		Temperature Classification	Frame Color Code	Glass Bulb Colors
°F	°C	°F	°C			
100	38	135–170	57–77	Ordinary	Uncolored or black	Orange or red
150	66	175–225	79–107	Intermediate	White	Yellow or Green
225	107	250–300	121–149	High	Blue	Blue
300	149	325–375	163–191	Extra high	Red	Purple
375	191	400–475	204–246	Very extra high	Green	Black
475	246	500–575	260–302	Ultra high	Orange	Black
625	329	650	343	Ultra high	Orange	Black

In places where the temperature is normally high (e.g. boilers, ovens and drying rooms) a sprinkler head with a higher temperature rating must be used. This is to make sure that the sprinkler head does not discharge water at the wrong time. If heads with a high temperature rating are used in ordinary room (e.g., an office, an apartment, and store) the value of the sprinkler protection is greatly reduced. This is because the temperature will have to increase much higher for the sprinkler heads to open.

Sprinkler systems are excellent for controlling fires. However, they can cause water damage if they are not shut down soon after the fire has been extinguished. No control valve on the system should be closed except on the order of the fire officer in charge. If the fire has been completely extinguished, the building owner or their representative may close the control valve. Sometimes the Fire Department has a difficult time finding the control valve to shut down the system. This problem can be prevented by keeping a small sketch of the sprinkler system and the position of the control valves. This sketch should always be readily available. This sketch is very helpful to the firefighters when they are responding to an affected premise.

10.3 BUILD-UP OF FOREIGN MATERIAL ON SPRINKLERS

Sometimes conditions exist which cause a build-up of foreign material on sprinkler heads. This may prevent the sprinkler head from working properly. This build-up is

commonly called loading. The build-up of foreign material insulates the sprinkler head. This build-up prevents the sprinkler from opening at the desired temperature.

If the build-up is hard, it may prevent the sprinkler from opening. Replace loaded sprinkler heads with new sprinkler heads rather than attempting to clean them. If the deposits are hard, attempts to clean the heads are likely to damage them. This damage may prevent the sprinkler heads from working properly. The damage may also cause the sprinkler head to leak.

Deposits of light dust are less serious than hard deposits. Dust build-up may delay the operation of sprinkler heads. However, it will not prevent the eventual discharge of water. Dust deposits can be removed using compressed air or a vacuum, provided the equipment does not touch the sprinkler.

Removal of protective caps and straps on glass bulb sprinklers shall be performed at the time of installation.

10.4 SPARE SPRINKLER HEADS

Sprinklers required for emergency replacement must be representative of the type of sprinklers installed along with the proper wrenches. These wrenches shall be provided in the spare head cabinet. It is critical sprinklers be replaced with devices that will perform similarly to the original system sprinklers. Sprinklers that are replaced during an emergency by unlicensed individuals require that the devices used have been verified appropriate for the protected area by a Master Fire Suppression Piping Contractor. . After activation by fire, sprinkler heads in close proximity to the affected area should be visually inspected and replaced, if required.

A stock of spare sprinklers (not less than 6) shall be kept on the premise where the temperature does not exceed 100 Degrees F and shall include all types and ratings installed in the protected facility and provided as follows:

Under **300** sprinklers **six**.
301 - 1000 sprinklers **twelve**.
 Over **1000** sprinklers **twenty four**.

10.5 PRESSURE TANKS

Pressure tanks are enclosed water tanks of limited size. Air pressure in the tank permits forceful discharge of water in the tank into the sprinkler system. A pressure tank may be used as a primary or secondary water supply for a sprinkler system. A pressure tank is usually housed in an enclosed structure. The temperature in the enclosure is kept at 40° Fahrenheit or above.

Pressure tanks are to be maintained at approximately two-thirds full of water and one-third full of pressurized air. The minimum acceptable air pressure inside the tank is 75 psi (pounds per square inch). The air pressure in the tank may be automatically maintained by an air compressor. The maximum gross capacity of pressure tanks is 9,000 gallons. Some sprinklers systems require more than 6,000 gallons of water. When

this occurs several pressure tanks are used in combination to supply the system. A standard pressure tank is shown in the sectional diagram below:

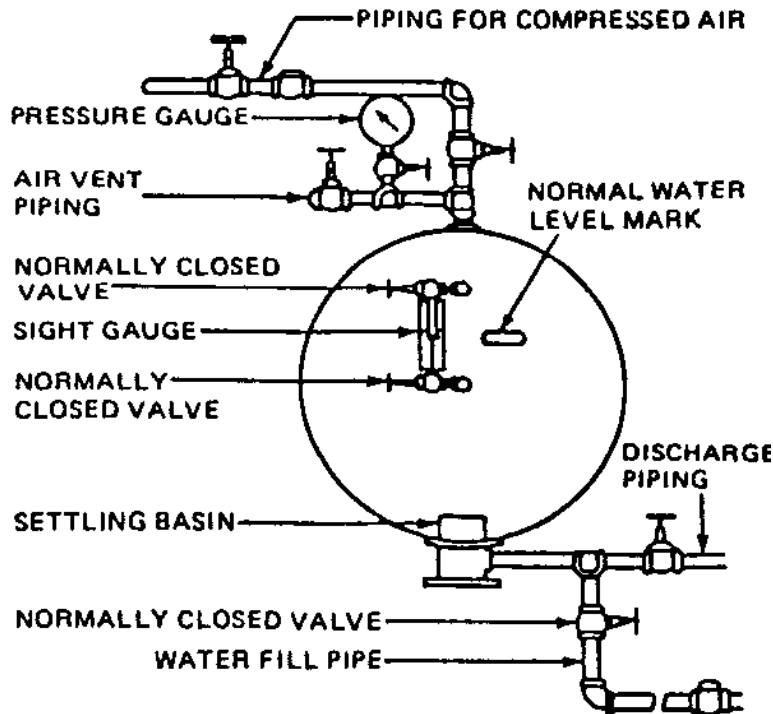

10.6 STANDARD PRESSURE TANK

Pressure Tank Alarms - All pressure tanks used to provide the required primary water supply for a sprinkler system shall be equipped with two high and low alarm systems. One system monitors the high and low air pressure. The other system monitors the high and low water levels. The alarm system automatically monitors the air-to-water volume ratio which should always be 1 (air) to 2 (water). An alarm signals the Certificate of Fitness holder or Central Station operator when the water level or the air pressure is too high or too low. When this occurs the pressure tanks shall be adjusted or repaired immediately.

Supervision of the Pressure Tank - The pressure tank may also be supervised by an approved central station company which monitors the entire sprinkler system. Supervisory devices are installed in the pressure tank. These devices alert the central station company when there is a problem with the tank's water level, air pressure, and water temperature. The devices also alert the central station company when water has been discharged from the tank. When sprinkler heads have fused and water has been discharged from the tank, the borough dispatcher is notified.

The central station company notifies the owner or the impairment coordinator, when a problem is caused by an equipment failure. Repairs and adjustments shall be made quickly to return the pressure tank to good working order.

10.7 GRAVITY TANKS

Gravity tanks are used for water storage. They are made of wood, steel, concrete or fiber glass. Gravity tanks are used as a primary or secondary water supply source for sprinkler systems. A gravity tank system delivers water from the tank through the sprinkler system without the use of pumping equipment.

A gravity tank should be at least 25 feet above the highest line of sprinkler heads that it supplies. Tanks may be located on the tops of buildings or raised on tall supporting towers. Examples of a typical gravity tank are shown below.

A Typical Gravity Tank

The water pressure in a gravity tank system depends on the elevation of the tank. This is the main advantage over other kinds of systems. For every 1 foot the tank is above the discharge outlet 0.433 psi (pounds per square inch) of water pressure is generated. In other words the higher the tank elevation the greater the water pressure. The gravity tank is extremely reliable. It does not depend on the operation of mechanical equipment to supply the sprinkler system.



Automatic fill pumps supply the water to most gravity tanks. The pumps fill the tank at a rate of 65 gpm (gallons per minute) or more. The floats turn on the fill pump when the water in the tank is too low. The floats shut off the pump when the desired water level is reached. The floats make sure the gravity tank always has the right amount of water to supply the sprinkler system. All gravity tanks have an overflow pipe that drains off excess water in the tank. This happens if the floats do not turn off the fill pump. A fill pump is not necessary if the water pressure in the city water main is able to keep the tank filled with the correct amount of water.

Gravity tanks are exposed to very low temperatures. All parts of the gravity tank must be insulated or heated to keep the water from freezing. Several methods are used to heat the tank and the pipe that supplies the water.

- (1) Hot water is circulated by gravity.
- (2) Steam is discharged directly into tank.
- (3) Steam coils are placed inside the tanks.
- (4) Heat from the sun is used.

The Certificate of Fitness holder can find out the temperature of the water by using a thermometer. The thermometer is located near the heating device. Severe damage can

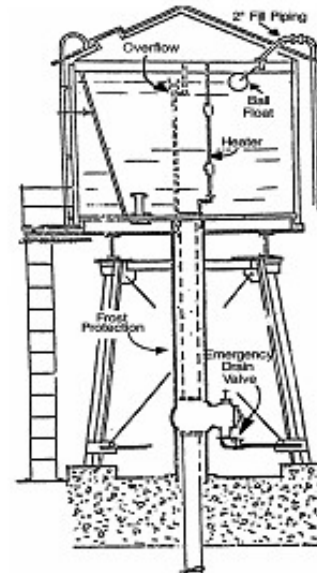

occur to the piping and the tank if the water inside the tank freezes. During freezing weather, the temperature of the water inside the tank and the riser must be checked daily or weekly. The temperature of the water shall always be at least 40° Fahrenheit.

Ice should not be allowed to build-up on the gravity tank. The extra weight of the ice might weaken the supports of the tank and cause the tank to collapse. Falling icicles may also cause damage or injury. It is essential to be sure that the tank is properly heated, insulated and carefully maintained.

The gravity tank must always have a full supply of water. A full tank of water is needed to ensure the sprinkler system works properly during a fire. Keeping the tank full of water also prevents wooden tanks from shrinking. A full tank of water helps keep steel tanks from rusting.

Gravity Tank Supervision - The gravity tank shall be constantly monitored to ensure that the tank and its parts are working. Electrical supervision devices monitor the water temperature and the water level in the gravity tank. These devices send signals to an approved central station company about the water level and water temperature. The central station company notifies the owner or the impairment coordinator when a problem with the gravity tank is detected. The owner shall correct the problem as soon as possible. The supervisory devices are sometimes called high and low alarms since they also send audible signals to alert the owner or impairment coordinator or central station when there is a problem.

The main reason a sprinkler system supplied by a gravity tank fails during a fire is because there is not enough water in the tank. The sprinkler system cannot be supplied if there is not enough water in the tank. A proper water level shall be maintained.

10.8 FIRE PUMPS

The Centrifugal Pump - The centrifugal fire pump is the standard pump currently used in fire protection systems. This is the preferred pump because it is reliable, compact, requires low maintenance, and it can be powered by a variety of drivers including: electric motors, diesel engines, and steam turbines. A typical centrifugal pump is shown in the diagram below:

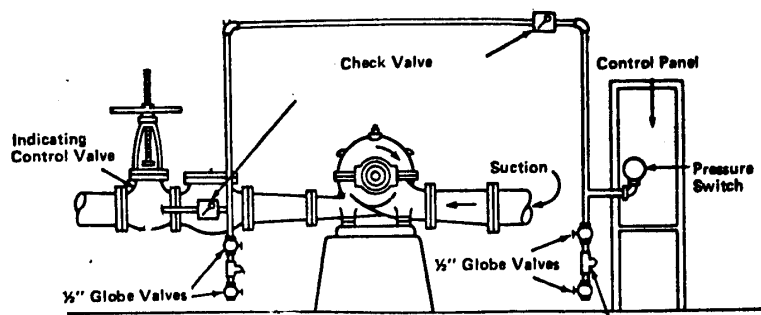

Centrifugal Pump

Principle of Operation - The water available to the centrifugal pump must always be under pressure because the pump is not designed to lift water for the supply source. A

water tank can be used if the tank supplies the pump due to gravity. In other words the weight of the water forces the water to flow into the pump. This type of water tank is called a suction tank. The water flows from tank through the supply inlet into the pump. As the water passes to the center of the pump it reaches a rotating impeller. This impeller is designed to grab the water on the inlet side of the pump and then discharge the water under increased pressure and flow into the fire protection system.

Depending on the model, centrifugal pumps are capable of discharging water from 25 gpm (gallons per minute) up to 5,000 gpm. Most centrifugal pumps have a single impeller and are therefore commonly called single stage fire pumps.

The Vertical Turbine Pump - A vertical turbine pump is really a modified centrifugal pump that has the capability to draw water from streams, ponds, wells etc. Unlike the standard centrifugal pump, the vertical turbine pump does not need the suction supply to be under pressure for it to operate. Instead it draws the water into the pump by suction. When it reaches the rotating impellers the water pressure and flow are increased and then forcefully discharged into the fire protection system.

Although the vertical turbine pump is capable of drawing water from wells it is generally not recommended to use a well as the main water supply source because it may dry up without warning. Should the well dry up it would make the turbine pump useless. It is better to draw water from the well and to fill a water storage tank. A fire pump should then be attached to a more reliable supply source such as storage or suction tank.

When using a pump to draw water from a suction supply source it is important to ensure the water intake hose, foot valve, and screens are inspected regularly. Mud, gravel, leaves and other debris may cause damage to the pump or obstruct the sprinkler system piping. A vertical fire pump arrangement using a water reservoir is shown below:

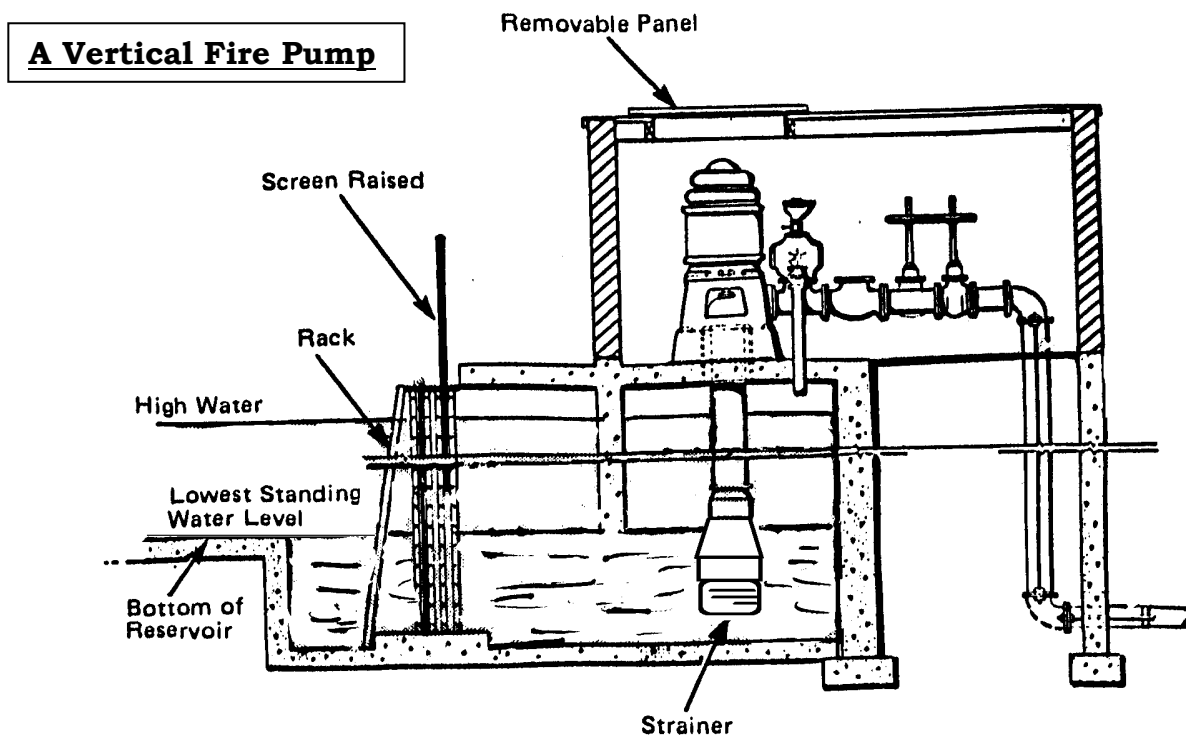

Pump Activation - Fire, booster or special service pumps supplying fire sprinklers are started automatically when there is a drop in water pressure in the system. Minor drops in water pressure are maintained by a pressure maintenance pump. When the drop of pressure in the system is greater than the capacity of the pressure maintenance pump, the pump is activated.

When **manually activated fill pumps** are installed they may be used in combination with a gravity or a pressure tank. These tanks are designed to operate when there is a pressure drop in the fire sprinkler system. The operation of the pressure tank and the triggering of its supervisory devices send a signal to a local alarm point in a building and may alert a central station monitoring company. After the alarms have sounded the Certificate of Fitness holder is required to refill the gravity and/or pressure tanks manually.

Sometimes remote push buttons are used to activate the pump. These remote push buttons are designed to start the pump but not to stop the fire pump.

Many fire pump controllers are manufactured with maximum run timers that automatically turn the fire pump OFF if an upper pressure limit has been reached. As per the FDNY Commissioner, these timers must be disabled for all automatic fire pumps in NYC.

Pressure Maintenance Pumps (Jockey Pumps) – Pressure maintenance pumps, sometimes referred to as jockey, or makeup pumps, are often found on sprinkler systems. These pumps are designed to automatically operate when there is a slight drop in pressure due to leakage in the system. The jockey pump restores the pressure in the fire protection system to the desired level. When the drop of pressure in the system is greater than the capacity of the jockey pump, the fire pump is activated. Because this pump is considered a "convenience" pump and does not supply flow or pressure during the event of a fire, it does not require inspection, testing or maintenance as per NFPA 25 or the NYC Fire Code.

Booster pumps - Booster pumps are used in sprinkler systems. These pumps are usually located in the basement. The booster pump is used when the water pressure available at the highest sprinkler head does not meet the demands of the sprinkler system. This pump increases the water pressure in the sprinkler system until it reaches acceptable levels. The booster pump should not be confused with pressure maintenance pumps (jockey pumps). Booster pumps shall be maintained according to NFPA 25 standard for fire pumps.

Special service pumps – Special service pumps are sometimes used in sprinkler and standpipe systems. These pumps are small pumps with limited power taking suction from gravity tanks. These pumps are used when the water pressure available does not quite meet the needs of the sprinkler/standpipe system. This small pump increases the water pressure and volume in the sprinkler/standpipe system until it reaches acceptable levels. The special service pump should not be confused with pressure maintenance pumps (jockey pumps). Special service pumps shall be maintained according to NFPA 25 standard for fire pumps.

Operation and Supervision - When fire pumps are activated by electric automatic controllers it is essential that they are constantly monitored to ensure the availability of the electrical power supply in case of an emergency. For this reason supervisory devices are installed on the pumps to alert the Certificate of Fitness holder and/or a central monitoring station when there is an electrical power failure. In cases where steam turbines or internal combustion engines are used similar supervisory devices are installed to signal when there is a problem with the controlling equipment.

Fire Pump Location - The fire pump should be housed in a room that is fire resistant or constructed noncombustible material. The pump room should be located as close as possible to the fire protection system. The pump room should be kept clean and accessible at all times. The fire pump, driver, and controller should be protected against possible interruption of service. The temperature inside the pump room should be maintained above 40 degrees Fahrenheit at all times to prevent freezing of the water. The pump room should only be used for fire protection functions and not for general plant operations. No storage is permitted in this room.

11. HANGING, BRACING AND RESTRAINT OF SPRINKLER SYSTEM PIPING

The structural support of the sprinkler system plays an integral part of system reliability. Missing or defective pipe hangers can cause the entire system to fail from piping rupturing or leaking. Great care and experience must be applied when evaluating the adequacy of the structural support of the system.

Piping shall be supported from the building structure in accordance with the NYC Code requirements and NFPA # 13, 2007 edition.

The annual visual inspection of system hanging components and bracing is the most complicated and difficult of all the tasks to be performed by the C of F holder. This reference is a starting point and by no means does it fully explain the various means, methods and requirements to adequately perform this annual inspection task. Chapter 9 of the NFPA#13 2007 edition describes in great detail the fundamentals of hanger design and installation and should be used as a reference guide for accurate inspection results that will be reported to the owner and FDNY.

There are any numbers of different deficiencies that may be found during the inspection process. They may include system supports being disturbed by the movement of adjacent equipment, deflection or sagging of the building structure, deterioration of the portion of the structure used to support the system and attaching excessive loads to hanging components or piping.

Unapproved or makeshift hangers such as perforated strapping or bailing wire are prohibited. Nails shall not be used to fasten the system or building attachments to the structure. Hangers used with plastic piping must be listed for use with the piping material.

A visual inspection of the system is performed from the floor to determine if the hangers, bracing and restraints are in place and if the piping has moved from its original location and position. This can be observed if the hanger rods or piping attachments are not being supported adequately from the building, bent, misaligned, loose or missing. Shifting of the system may occur during pressure surges, water hammer, alterations, testing, or operation.

The visual inspection of hanging and bracing for sprinkler systems is not required for piping concealed by building construction above ceilings and in concealed spaces. When there is an indication of concealed piping system's sprinklers heads either too far above or below a hung ceiling, further investigation is required to determine if hangers and supports are defective or missing.

No other components shall be supported using the sprinkler system piping or hanger assemblies supporting the system.

There are many variations in hanger assemblies and a few common types illustrated below:

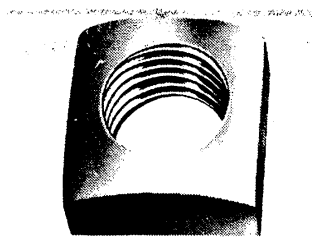

SQUARE NUTS

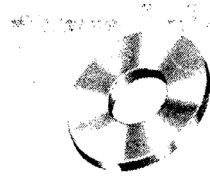

ROUND STEEL WASHERS

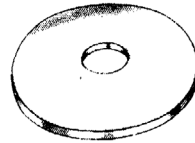

FENDER WASHER

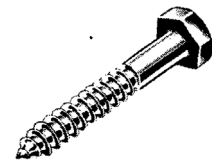

LAG SCREW

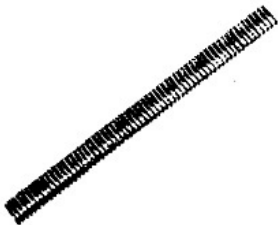

FULL THREADED STUD



DRIVE SCREW

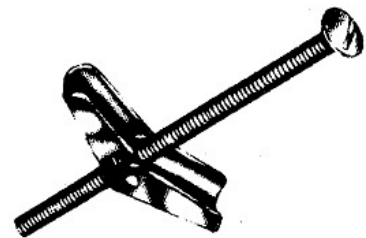

TOGGLE BOLT with Wing

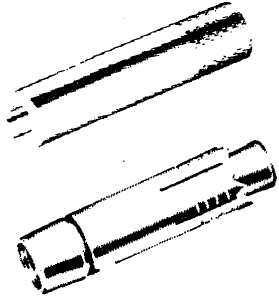

CONCRETE ANCHORS

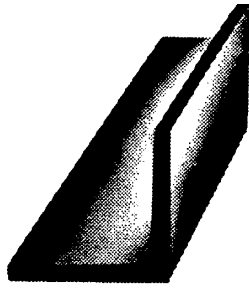

STEEL SECTIONS

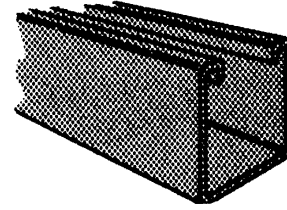

STRUT

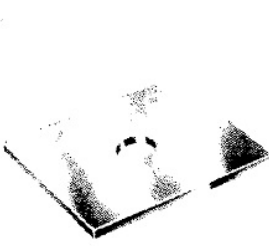

FISH PLATE

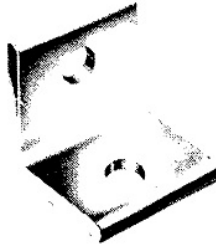

ANGLE KNEE BRACKET

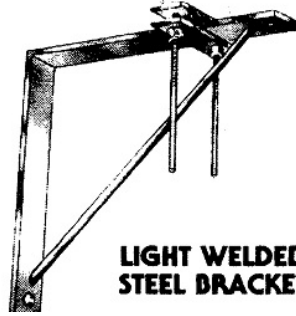

**LIGHT WELDED
STEEL BRACKET**



MEDIUM WELDED BRACKET

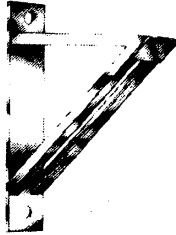

HEAVY WELDED BRACKET



ANGLE IRON BRACKET

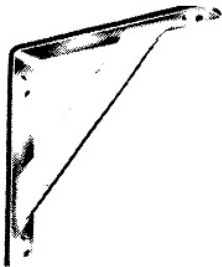

LIGHT DUTY BRACKET

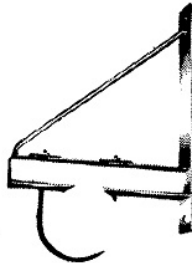

**ADJUSTABLE
SUSPENSION BRACKET**

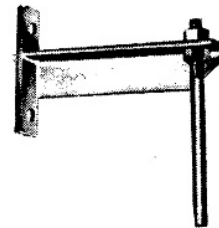

CANTILEVER BRACKET



EQUIPMENT ANCHOR BOLT

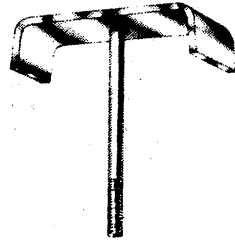

METAL DECK CEILING BOLT



ROD COUPLING



EXTENSION PIECE

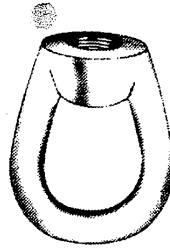

WELDLESS EYE NUT



EYE SOCKET

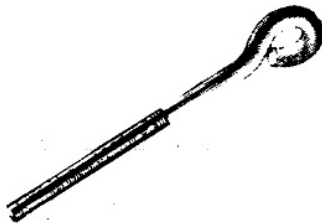

PLAIN EYE ROD



WELDED EYE ROD



WELDED BULL RING



PLAIN HANGER ROD

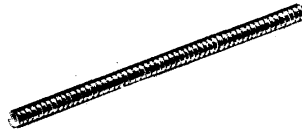

FULL THREADED ROD

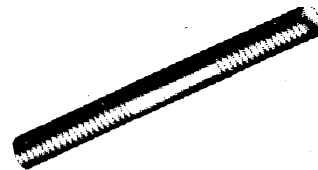

HANGER ROD



LAG AND MACHINE ROD



ANCHOR BOLT

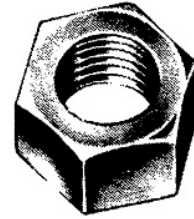

NUTS

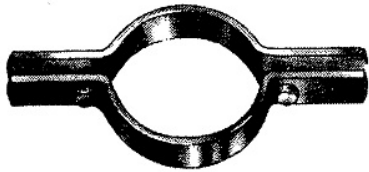

RISER CLAMP

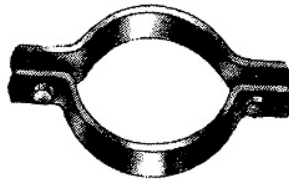

**SHORT ARM
RISER CLAMP**



**STANDARD
STEEL PIPE CLAMP**



**HEAVY
STEEL PIPE CLAMP**



**LONG AND SHORT ARM
RISER CLAMP**

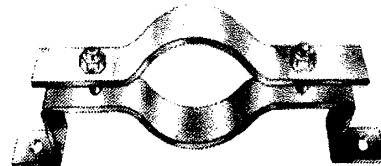

**OFFSET
PIPE CLAMP**



EXTENDED PIPE CLAMP



PIPE SADDLE SUPPORT

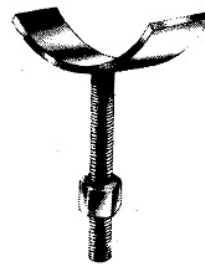

ADJUSTABLE PIPE SUPPORT



**ADJUSTABLE PIPE SADDLE
SUPPORT
with Coupling**



PIPE SADDLE SUPPORT

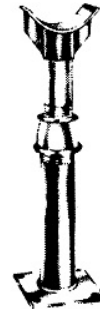

**ADJUSTABLE
PIPE SADDLE SUPPORT**



HANGER FLANGE

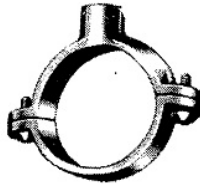

**SPLIT RING
EXTENSION HANGER**



**ADJUSTABLE SWIVEL RING
HANGER**

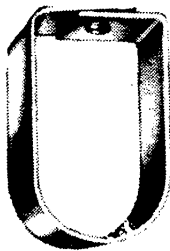

BAND HANGER

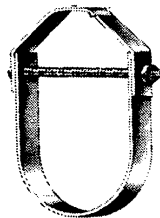

CLEVIS HANGER

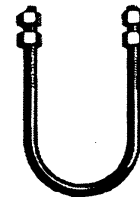

STANDARD U-BOLT

11.1 A BRIEF OVERVIEW OF PIPING AND SUPPORT FUNDAMENTALS

Sprinkler system piping is categorized as follows:

Branch lines are directly connected to sprinkler heads.

Cross mains or **loop mains** are directly connected to branch lines.

Feed mains are directly connected to cross mains or loop mains.

Risers are able to supply feed mains or cross mains directly. The vertical supply pipes in a sprinkler system.

The spacing of hangers varies with the material and diameter of the piping, the location of piping connections, ability of the structure to support the piping, the location of the piping in relation to the building structure, and system the attachments.

Hangers generally consist of an attachment to the piping, an attachment to the building structure, and a ferrous rod attaching the components together. Hanging components are generally required to be listed devices; however, a licensed professional engineer may also certify that a hanger or hanging assembly may be used.

A partial list of specific hanger spacing requirements is noted below:

Standard wall steel pipe with diameters 1 inch and 1 ¼ inch are required to have hangers placed at a maximum of 12 feet apart. For all other pipe diameters the maximum distance between hangers is 15 ft.

The maximum hanger spacing for threaded light wall steel pipe shall not exceed 12 ft apart.

The maximum hanger spacing for CPVC (plastic) pipe varies from a maximum 5 ft 6 inches for ¾ inch piping to a maximum 10 ft on center for 3 inch.

There are extensive additional hangings and bracing requirements for CPVC piping and the installation and design manuals for this product must be referenced to perform adequate visual inspections required by the standard.

The distance for the hanger assembly to the centerline of an upright sprinkler head shall not be less than 3 inches. Hangers placed closer to sprinklers will cause an obstruction to the discharge pattern.

For systems operating at less than 100 psi, the unsupported length between the end sprinkler head and the last hanger on the line shall not exceed 36 inches for 1 inch piping, 48 inches for 1 ¼ inch piping, and 60 inches for piping 1 ½ inch or larger.

For systems operating at pressures of 100 psi or greater, the hanger closest to the last sprinkler on the line shall be of the type that prevents the upward movement of the piping within the hanger assembly. This can be accomplished by the use of a surge restrainer.

The cumulative length of an unsupported arm over to a sprinkler head, sprinkler drop, or sprinkler sprig-up shall not exceed 24 inches for steel pipe and 12 inches for copper pipe.

System risers (vertical piping passing from floor to floor) shall be supported with riser clamps and hangers located within 24 inches of the centerline of the riser. The distance between supports for risers shall not exceed 25 feet.

The minimum size hanger rods are required as follows:

<u>Pipe Diameter in inches</u>	<u>Rod Diameter in inches</u>
Up to and including 4	3/8
Five, Six and Eight	1/2
Ten and Twelve	5/8

Seismic Restraints

The NYC Building Code adopted earthquake code requirements. This reclassification requires the installation of sway bracing for earthquake protection be installed on sprinkler systems in buildings built after 1998.

The system piping shall be braced to resist both lateral and longitudinal horizontal seismic loads and to prevent vertical motion resulting from seismic events. Lateral braces shall be spaced at a maximum of 40 feet on centers and are required on all piping 2 1/2 inch and larger. The distance from the last brace to the end of the pipe being braced shall not exceed 20 feet for systems constructed under the 2008 Building Code. The distance from the last brace to the end of the pipe being braced shall not exceed 6 feet for systems constructed under the 2014 Building Code.

Longitudinal braces shall be spaced at a maximum of 80 feet on centers and are to be provided on feed and cross mains.

Piping shall be protected against damage where subject to earthquakes by the use of flexible couplings for piping 2 1/2 inch and larger. Flexible connection shall also be provided at building expansion joints, and within 24 inches of top and bottom of the piping dropping down to in rack sprinklers and mezzanines regardless of pipe size.

To avoid damage to piping passing through holes in platforms, walls, floors and foundations, a clearance of at least 2 inches shall be provided around the piping and the penetration. If this is not provided flexible couplings shall be provided within 1 foot on both sides of the wall, floor, beam openings or platforms.

Risers exceeding 3 feet in length shall be equipped with a four way brace with distances between braces not to exceed 25 feet.

All parts of bracing and fittings attaching bracing to the piping shall lie in a straight line to avoid uneven loading of fittings and fasteners.

Examples of seismic restraints are shown below:

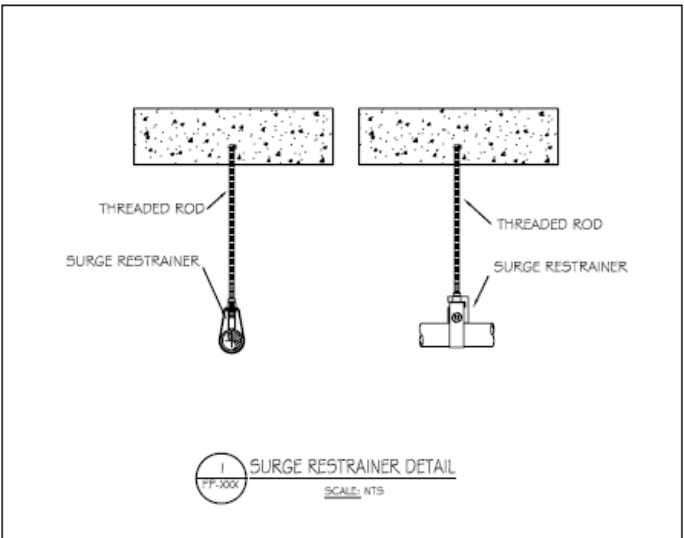
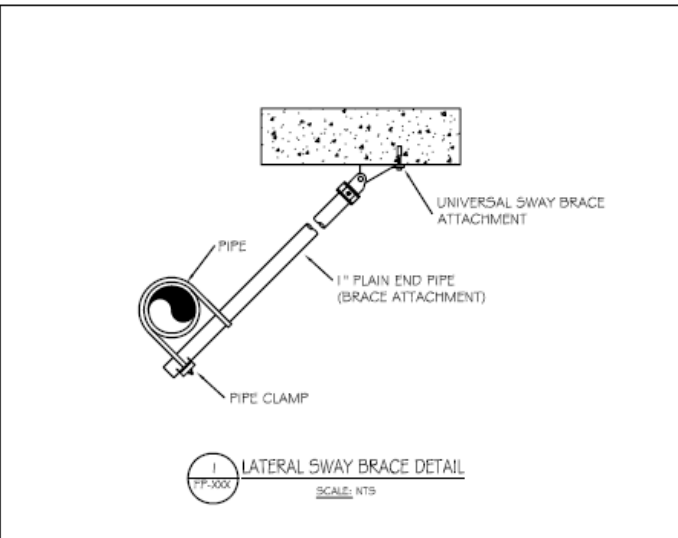
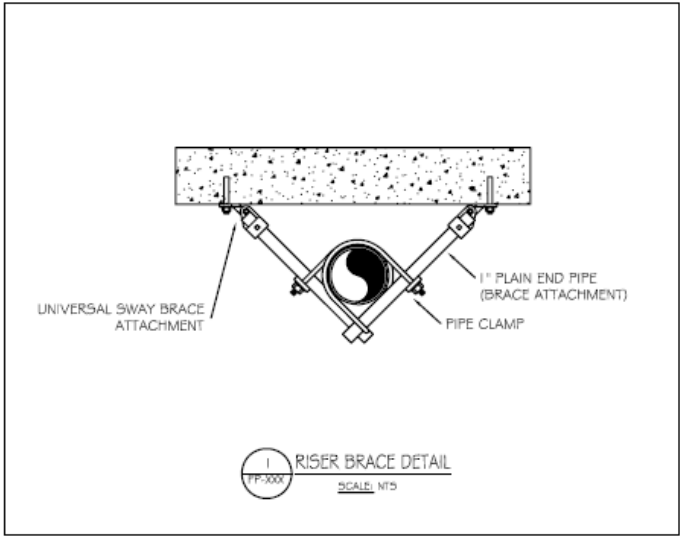
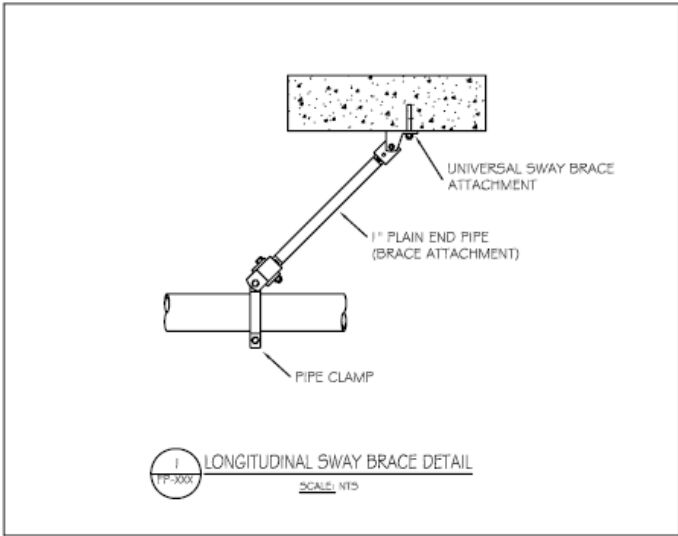

12. INSPECTION, TESTING AND MAINTENANCE FREQUENCIES

12.1 INSPECTION AND MAINTENANCE OF PRESSURE TANKS

The water level and air pressure in pressure tanks shall be inspected and maintained in accordance with NFPA#25, 2011 edition. The water level and air pressure must provide an adequate water supply to the sprinkler system. The capacity of the compressor shall be sufficient to build-up the tank pressure to 75 psig within 3 hours or less. The water gauge valve shall be opened to examine the water level. When the valve is opened the water will flow into the gauge. This allows the Certificate of Fitness holder to compare the water level in the tank to the desired water level mark. Adjustments to the water level should be made as needed. After visually inspecting the water gauge valve, the valve should be closed. When the valve is closed, the water and air in the tank are isolated from the sight glass. If the gauge glass breaks the volume of water and the air pressure are not affected.

The inside of pressure tanks shall be inspected carefully in accordance with NFPA 25, 2011 table 9.1.1.2. Rusting in the tank may require repainting or other repairs. The inside of the tank should be thoroughly scraped, wire brushed and repainted. No foreign materials should be allowed to fall into the sprinkler system.

The temperature inside the structure housing the pressure tank should be checked daily during cold weather to make sure that the temperature is at least 40° Fahrenheit at all times.

12.2 INSPECTION AND MAINTENANCE OF THE GRAVITY TANK

The gravity tank shall be regularly inspected and maintained in accordance with NFPA #25, 2011 edition. Maintenance is needed to be sure that the tank functions correctly. Tanks are to be painted regularly to prevent rusting. Before the inside of a gravity tank is repainted the surface should be thoroughly dried. All loose paint, rust, scale, and other surface contamination should be removed. The outside of the gravity tank will require local patching. A complete finish coat of paint is needed when the paint has weathered thin. A new coat of paint also improves the appearance of the tank after it has been patched. Painters shall be careful that scrapings or other foreign materials do not fall down the outlet into the sprinkler piping. The discharge outlet shall be covered for protection during repairs. Only a few sheets of paper or a paper bag tied over the end of the settling basin stub should be used. The paper shall be removed immediately after the job is finished.

It is best if gravity tanks are used only for fire protection and for no other purpose. Tanks used for other purposes need to be refilled more often. The FDNY borough dispatcher shall be notified when a tank cannot be used for any reason.

12.3 PUMP INSPECTION AND MAINTENANCE

In order to ensure the reliable operation of the pump in the case of an emergency, regular inspections and maintenance shall be conducted by the Certificate of Fitness holder. The pump shall be activated as indicated in the reference guide and run for 10

minutes in accordance with the manufacturer's specifications. When the pump is in operation a small water leak on the pump bearings is desirable and should not be considered a malfunction. Additionally, water should discharge from a circulation relief valve (electric pump) or heat exchanger (diesel pump) while the fire pump is operating under a "no-flow" condition.

If an automatic controller operates the fire pump, the pump shall be activated by reducing the water pressure in the system. This can be done by opening the test drain or initiating a large water flow from the system. By starting the fire pump this way the Certificate of Fitness holder can determine if the automatic controller is working properly. Care shall be taken to make sure that the pump does not overheat while conducting the test.

The centrifugal pump relies on the water supply for cooling and lubrication and shall never be operated without the pump being supplied with water.

A visual inspection of all parts of the pump and the controlling equipment shall also be conducted in accordance with the reference guide. This inspection includes the condition and reliability of the power supply. If any problems are discovered with the equipment immediate action shall be taken to correct the problem. Fire, booster and special service pumps shall be fully tested annually to make sure that the pump, driver, power supply and all other parts are functioning properly.

12.4 COMMON DEFICIENCIES

Common Deficiencies - The most common sprinkler system deficiencies include painted or loaded sprinkler heads, building contents located less than 18 inches below sprinkler deflectors, changes from the original wall locations, ceiling heights, and positioning of mechanical equipment. For concealed sprinkler systems, cover plates with non-factory coatings and the lack of required gap between cover plate and ceiling and blocking of the spray patterns from light fixtures close to the sprinklers are the most common deficiencies seen in the field. Missing trim or cover plates not attached properly to sprinklers may indicate hanger deficiencies and may not allow the sprinkler deflectors to drop below the ceiling blocking the spray pattern.

The C of F holder shall assume that the system being inspected is installed in accordance to the NYC Building Code in effect at the time of installation. The C of F holder is to report those items of change that impact the system components regarding, compliance with any retroactive requirements, the condition of the water supply control valves, water and air levels in tanks and condition of same, unusual changes in water supply or system pressures, condition and accessibility of control valves, fire department connections, clearance around sprinkler heads, accessibility of curb valve box, system control valves, required signage, attachments to piping other than system components, misaligned piping due to impact, missing pipe hangers and supports, excessive operation of pressure relief valves, easily recognized recalled sprinkler heads and visible leakage.

Factors that may require further investigation: Installations that don't appear to be correct including sprinkler heads located more than 22 inches below the ceiling or structure, sprinklers not installed in accordance with their listing, using sprinklers with different RTI in the same protected area or the wrong RTI for the occupancy classification, undersized piping, incompatible piping materials, flexible sprinkler hoses not attached to the building structure, along with areas of the building not protected by the sprinkler system all require further investigation by a qualified MFSPC.

When sprinklers are replaced, the following information is critical to be certain that the correct devices have been used. Sprinklers with different diameter glass bulbs will have a different RTI and must not be used together in the same compartment. Defective sprinklers without SIN identification shall be replaced with devices that perform a similar function. They shall have the same RTI, temperature rating, discharge pattern and orifice size. Residential/hotels group R (J in pre 2008 code) residential sprinklers are required in all sleeping compartments. Quick response sprinklers are required in all other portions of the facility. Business/Office group B(E in pre 2008 code), Institutional I(H in pre 2008 code), Education E (G in pre 2008 code), require quick response sprinklers be installed in all occupied areas.

Glass bulb sprinklers are sensitive to damage and are required to be shipped from the factory with protection. The orange "caps and straps" need to be removed prior to putting the system in service. The sprinkler will fail to operate with these devices in place.

12.5 A COMPLETE SUMMARY OF TASKS OF INSPECTION, MAINTENANCE & TESTING

12.5.1 INSPECTION

A. Sprinkler Systems:

Gauges:

- On dry, preaction and deluge systems shall be inspected **weekly** to ensure that normal air and water pressures is maintained;
- Where air pressure supervision is connected to a constantly attended location shall be inspected **monthly**;
- On wet pipe sprinkler system shall be inspected **monthly** to ensure good condition & that normal water supply pressure are being maintained.

Heat Tape

- Heat tape should be inspected at least **annually** prior to freezing temperatures.
- It shall be inspected per manufacturer's requirements. (5.2.7)

Alarm Devices:

- Alarm devices shall be inspected **quarterly** to verify that they are free of physical damage.

Supervisory Signal Devices:

- Supervisory signal devices shall be inspected **quarterly** to verify that they are free of physical damage.

Hydraulic Name Plate:

- For hydraulically designed systems shall be inspected **quarterly** to ensure that it is attached securely to the sprinkler riser or sprinkler control valve and is legible.

Information Sign:

- The information sign shall be inspected **annually** to verify that it is securely attached and is legible. (4.1.8)

Information signs shall indicate the following:

1. location of the area served by the system.
2. location of auxiliary drain and low point drains for dry and pre-action systems.
3. location and presence of anti-freeze or other auxiliary system.
4. presence and location of heat tape.

Buildings (4.1.1.1)

- Shall be inspected **annually**, the building owner shall ensure that all areas of the building containing water-filled piping shall be maintained at a minimum temperature of 40°F and not exposed to freezing conditions.

Drainage in system area (NFPA 11.2.8)

- The area beneath and surrounding a foam water spray system shall be inspected to ensure that drainage facilities, such as trap sumps and drainage trenches, are not blocked and retention embankments or dikes are in good repair.

Hanger/Seismic Braces:

- Hangers installed in concealed space such as above suspended ceilings shall not need inspection;

- Hangers installed in areas that are inaccessible for safety considerations due to process operations shall be inspected during each scheduled shutdown.
- Hangers and braces shall be inspected annually from floor level to ensure they are in place, properly aligned and otherwise not damaged. All defects and deficiencies shall be corrected.

Pipe and Fittings:

- Shall be inspected **annually** from the floor level to ensure there is no mechanical damage, leakage, corrosion, misalignment and that required supports and bracing are in place and are in good condition. Nothing shall be attached to any sprinkler system component.
- Pipe installed within concealed (such as above suspended ceilings spaces) are not required to be inspected. Exposed piping installed in areas that are inaccessible for safety considerations due to process operations shall be inspected during each scheduled shutdown.
- Pipe installed in areas that inaccessible shall be inspected during each scheduled shutdown;

Spare Sprinkler Heads/Wrenches:

- The supply shall be inspected **annually** for the proper number and type of sprinklers and a sprinkler wrench for each type of sprinkler.

Sprinklers:

- Sprinklers shall be inspected from the floor level **annually** for signs of leakage, corrosion, foreign materials, paint and physical damage; and shall be installed in the proper orientation (such as upright, pendent or sidewall). If the above problem occurs the sprinkler shall be replaced;
- Glass bulb sprinklers shall be replaced if the bulbs have emptied;
- Unacceptable obstructions to spray patterns shall be corrected;
- Sprinkler installed in concealed (such as above suspended ceilings spaces) are not required to be inspected.
- Sprinklers installed in areas that are inaccessible for safety considerations due to process operations shall be inspected during each scheduled shutdown.

B. Fire, Booster and Special Service Pumps:

Pump House, Heating Ventilating Louvers:

- The visual inspection shall be performed **weekly** to ensure heat is not less than 40°F (4.4°C) and 70°F (21°C) for pump room with diesel pumps without engine heaters.
- Ventilating louvers shall be free to operate.

Fire, Booster and Special Service Pump System:

- A **weekly** visual inspection shall be made to ensure the pump suction and discharge and by-pass valves are fully open;
- All piping shall be free of leaks;
- Suction line pressure gauge readings shall be normal and reservoir is full;
- System line pressure gauge readings shall be normal;
- Wet pit suction screens shall be unobstructed and in place.

Diesel Engine Pump System:

- **Fuel system** – Tank level shall be 2/3 full, the tank float switch shall be in auto position, solenoids valve operational, check for water in the fuel system and condition of flexible hoses connectors **weekly**.
- **Lubrication system** - Oil level in right angle gear drive is normal and ensure that lube oil heater is adequately lubricated **weekly**;
- **Cooling system** – Check level, adequate cooling water to heat exchanger, water pump, condition of flexible hoses and connections **weekly**; **annually** inspect duct work, clean louvers (combustion air);
- **Exhaust system** – check for any leakage, the drain condensate trap **weekly**; **Quarterly** check insulation and fire hazards;
- **Battery system** – Check electrolyte level of battery system along with the charger and charge rate **weekly**;
- **Monthly** – Remove corrosion on pump casing, clean and dry housing;
- **Quarterly** – Check that terminals clean and tight;

Electric Motor Pump System:

A general inspection, such controller pilot light on, transfer switch is closed, reverse phase alarm pilot light is off or normal phase rotation pilot light is on oil level in vertical motor sight glass is normal **weekly**.

- Check **monthly** circuit breakers or fuses;
- Check **quarterly** for wire chafing where subject to movement.

C. Water Storage Tank:

Water Level:

- Tanks without supervised water level alarms constantly attended location shall be inspected **monthly**.
- Tanks with supervised water level alarms constantly attended location shall be inspected **quarterly**.

Water Temperature:

- The temperature of water tanks shall not be less than 40°F (4°C).
- The temperature of water in the tanks **with** low temperature alarms NOT connected to a constantly attended location shall be inspected and recorded **weekly** during the heating season.
- The temperature of water in the tanks with low temperature alarms connected to a constantly attended location shall be inspected and recorded **monthly** during the heating season.

Heating System (inspection required prior to and during cold weather/heating season only):

- The heating system and components including piping without a low temperature alarm shall be inspected **daily**.
- The heating system and components including piping with a low temperature alarm shall be inspected **weekly**.

Air Pressure:

- Air pressure **without** supervised air pressure source shall be inspected **monthly**.
- Air pressure **with** supervised air pressure source shall be inspected **quarterly**.

Tank Exterior:

- The **exterior** of the tank, supporting structure, vents, foundation, and catwalks or ladders shall be inspected **quarterly** for damages and weakening.
- The area surrounding the tank shall be inspected **quarterly** to ensure it is free of combustible storage, trash, debris, brush, or material that could present a fire exposure hazard.
- Any accumulation of material on or near parts that could result in accelerated corrosion or rot; ice build up; the exterior side and top of embankments supporting coated fabric tanks are free of erosion.
 - o **Exterior** painted, coated or insulated surfaces of the tank and supporting structure, where provided shall be inspected **annually** for signs of degradation.
 - o **Expansion Joints** shall be inspected **annually** for leaks and cracks.

Hoops and Grillage of a wooden tank shall be inspected **annually**.

Interior Inspection - The interior of **steel tanks** without corrosion protection shall be inspected every **3 years**. The interior of all other types of tanks shall be inspected every **5 years**. The tank interior shall be inspected for signs of pitting, corrosion, rots other forms of deterioration waste materials and debris aquatic growth and local or general failure of interior coating.

Automatic Tank Fill Valves (serving dedicated fire sprinkler reserve tanks)

Strainers, filters, orifices shall be inspect/cleaned **quarterly**.

Enclosures should be inspected during cold weather – (without temperature monitoring – **daily**)/(with temperature monitoring – **weekly**).

Exterior automatic tank fill valves should be inspected monthly.

Interior automatic tank fill valves should be inspected **annually** (without external reset)/**5 years** (with external reset).

D. Valve and Valve Component:

Preaction/Deluge Valves:

- The valve **enclosure** heating equipment subject to freezing conditions shall be inspected **daily** during cold weather for its ability to maintain a minimum temperature of at least 4°C (40°F);
- Valves **enclosures** equipped with **low temperature alarms** shall be inspected **weekly** during cold weather.
- **Exterior valves** shall be externally inspected **monthly** to ensure it is free from physical damage, the valve seat is not leaking, all trim valves are in the appropriate open or closed position and electrical components are in service.
- The interior of the valve and the condition of detection devices shall be inspected **annually** when the trip test is conducted.
- Internal inspection of valves that can be reset without removal of a faceplate shall be permitted to be conducted every **5 years**.
- **Strainers, filters, restricted orifices** and diaphragm chambers shall be inspected internally every **5 years** unless test indicate a greater frequency is necessary.
- Foam concentrate strainers shall be inspected visually to ensure the blow-down valve is closed and plugged.

Dry Pipe Valves/Quick Opening Devices:

- The valve **enclosure** heating equipment subject to freezing conditions shall be inspected **daily** during cold weather for its ability to maintain a minimum temperature of at least 4°F (40°C);
- Valves **enclosures** equipped with **low temperature alarms** shall be inspected **weekly** during cold weather.
- Gauges on systems other than those with low air or nitrogen pressure alarms shall be inspected **weekly**.
- Gauges on systems with low air or nitrogen pressure alarms shall be inspected **monthly**.
- **Exterior** dry pipe valves shall be externally inspected **monthly** to ensure they are free from physical damage, the intermediate chamber is not leaking, all trim valves are in the appropriate open or closed position and electrical components are in service.
- The **interior** of the dry pipe valves shall be inspected **annually** when the trip test is conducted.
- **Strainers, filters, restricted orifices** and diaphragm chambers shall be inspected internally every **5 years** unless test indicate a greater frequency is necessary.

Backflow Prevention Assemblies:

- The double and single check assembly valves and double check detector assembly valve shall be inspected **weekly** to ensure that the OS&Y isolation valves are in the normal open position;
- Valves secured with locks or electrically supervised shall be inspected **monthly**.
- Reduced pressure assemblies (RPA or RPZ) shall be inspected **weekly** to ensure that the differential-sensing valve relief port is not continuously discharging and the OS&Y isolation valves are in the normal open position. (13.6.1.2)

Fire Department Connections:

- FD connection shall be inspected **quarterly** to verify the connections are visible and accessible, couplings or swivels are not damaged and rotate smoothly;
- Plugs or caps shall be in place and undamaged;
- Gaskets shall be in place and in good working conditions;
- Identification signs are in place (such as distance to the nearest fire hydrant);
- The check valve are fully operational and not leaking;
- The automatic drain valve shall be installed in horizontal position and properly operating;
- The clapper shall be in place and operating properly.

Control Valves:

- All indicating valves controlling water supplies shall be sealed, locked or provided with other approved methods as outlined in NFPA 25, 2011 edition. A seal is defined as an easily removable device (no key required) that will indicate the unauthorized operation of a valve. Using this method shall require **weekly** inspections of each valve by the C of F holder. All indicating valves controlling water supplies equipped with locks and/or supervised shall be inspected **monthly**.

- The inspection shall verify that, it is the normal open or closed position, properly sealed, locked, or supervised, provided with appropriate wrenches, free from external leaks and provided with appropriate identification.

Pressure Reducing and Relief Valves:

Fire Pumps:

- **Casing relief valves** – all circulation relief valves shall be inspected monthly, **consistent with the required frequency of the no-flow churn test** to verify that water flows through the valve when the fire pump is operating at shut-off pressure (i.e. churn) to prevent the pump from overheating.

***NOTE: As required by the Fire Department Commissioner.**

- **Pressure relief valves** shall be inspected monthly, **consistent with the required frequency of the no-flow churn test** to verify that the pressure downstream of the relief valve fittings in the fire pump discharge piping does not exceed the pressure for which the system components are rated.

***NOTE: As required by the Fire Department Commissioner.**

Proportioning Systems: (NFPA 25 11.2.9)

- The components of the various proportioning systems described in this study material shall be inspected in accordance with the frequency specified in tables below.
- Valves specified to be checked shall be permitted to be open or closed, depending on specific functions within each foam-water system.
- The position (open or closed) of valves shall be verified in accordance with specified operating conditions.
- Inspection of the concentrate tank shall include verification that the quantity of foam concentrate satisfies the requirements of the original design.
- Additional inspection requirements shall be performed.

Sprinkler Systems:

- All valves shall be inspected **quarterly** to verify the valve in the open position, not leaking in a good condition, with hand wheels installed and unbroken. Down stream pressures shall be maintained in accordance with the design criteria.

Hose Connections:

- All valves shall be inspected **annually** to ensure the hand wheel is not broken or missing, the outlet hose threads are not damaged and without leaks. The reducer and the cap shall not be missing. (13.5.2.1)

Hose Racks:

- All valves shall be inspected annually to ensure hand wheel is not missing or broken and that there are no leaks. (13.5.3.1)

Alarm Valves:

- **Exterior** alarm valves shall be externally inspected **monthly** to ensure the gauges indicate normal supply water pressure is being maintained. The valve shall be free

of physical damage and all valves are in the appropriate open or closed position. The retarding chamber or alarm drains shall be in a good condition without leaks.

- All **alarm valve** and their associated **strainers, filters, and restricted orifices** shall be inspected **internally** every **5 years** unless test indicate a greater frequency is necessary.

Check Valves :

- Shall be inspected **internally** every **5 years** to verify that all components operate correctly, move freely and are in good condition.

12.5.2 TESTING

A. SPRINKLER SYSTEMS:

Alarm Devices:

- Mechanically operated water flow alarms on wet pipe systems shall be tested **quarterly**;
- Vane and pressure type water-flow devices shall be tested **semiannually**;
- Testing of the water flow alarm on wet pipe systems shall be performed by opening the inspector's test connection. Where freezing weather conditions or other circumstances prohibits the use of the inspectors test connection, the bypass connections shall be permitted to be used.

Fire pumps shall not be taken out of service during testing unless constantly attended by qualified personnel or all impairment procedures contained in Chapter 15 are followed.

Main Drains:

- The test shall be conducted **annually** at each water-based fire protection system riser to determine whether there has been change in the condition of the water supply piping and control valves.
- In systems where the sole water supply is through a backflow preventer and/or pressure reducing valves, the main drain test of at least one system downstream of the device shall be conducted on a quarterly basis.
- When there is a 10 percent reduction in full flow pressure when compared to the original acceptance test or previously performed tests, the cause of the reduction shall be identified and corrected if necessary.

Antifreeze Solution:

- The freezing point of solutions in antifreeze shall be tested annually by measuring the specific gravity with hydrometer or refractometer.
- Antifreeze concentrations of glycerin shall not exceed 48%. If propylene glycol is used it should not exceed 38%.
- If during an annual test, the concentration is found to be outside of the required as stated above the system must be drained and replaced with a factory pre-mix solution.

Gauges:

- Gauges shall be replaced every 5 yrs or tested every 5 yrs by comparison with a calibrated gauge. Gauges that are not accurate within 3% of the full scale shall be recalibrated or replaced.

Sprinklers – Extra High Temperature:

- Representative samples of solder-type sprinklers with a temperature classification of extra high 325°F (163°C) or greater that are exposed to semi continuous to continuous maximum allowable ambient temperature condition shall be tested at 5 year intervals.

Sprinklers – Fast Response:

- Tested at 5 year using fast-response elements that have been in service for 20 years shall be tested. They shall be retested at 10 year intervals. Sprinklers from sample areas that do not pass performance standards shall be replaced.

Sprinklers:

- Where sprinklers have been in service for 50 yrs, they shall be replaced or a representative samples from one of more sample areas shall be tested. Sprinklers from sample areas that do not pass performance tests shall be replaced. Test procedures shall be repeated at 10 yr intervals. All sprinkler heads manufactured prior to 1920 shall be replaced. Where sprinklers have been in service for 75 years, they shall be replaced or representative samples from one or more sample areas shall be submitted to a recognized testing laboratory acceptable to the FDNY for field service testing and repeated at 5-year intervals.
- Dry sprinklers that have been in service for 10 years shall be replaced or representative samples shall be tested and then retested at 10-year intervals. Where one sprinkler within a representative sample fails to meet the test requirement, all sprinklers within the area represented by that sample shall be replaced.

Complete foam-water system(s): (NFPA 25 11.3.3)

- The maximum number of systems expected to operate in case of fire shall be tested simultaneously to check the adequacy of the water supply and concentrate pump.

Foam-water solution: (NFPA 25 11.3.5)

- During the full flow foam test, a foam sample shall be taken.
- The foam sample shall be checked by refractometric or other methods to verify concentration of the solution.
- Concentration shall be within 10 percent of the acceptance test results but in no case more than 10 percent below minimum design standards.

B. FIRE, BOOSTER AND SPECIAL SERVICE PUMPS:**Pump Operation:**

- A test of the fire pump assemblies shall be conducted **without flowing water** and shall be performed by starting the pump automatically (if applicable).
- Diesel driven pump shall be operated **weekly** and shall run for a minimum of **30 minutes**.
- Electrically driven pumps shall be operated **monthly** and shall run for a for a minimum of **10 minutes**.

Annual Flow Testing:

- An **annual** test of each pump assembly shall be conducted under minimum rated and peak flows of the fire pump by controlling the quantity of water discharged through approved test devices.

Alarm conditions shall be simulated by activating alarm circuits at alarm sensor locations, and all such local or remote alarm indicating devices (visual and audible) shall be observed for operation.

C. WATER STORAGE TANKS:

The tank heating system, where provided, shall be tested prior to the heating season to make certain it is in the proper working order.

Temperature Alarms:

- Low water temperature alarms shall be tested **monthly** cold weather only.

High Temperature Limit Switches:

- High water temperature limit switches on tank heating system shall be tested **monthly** whenever the heating system is in service.

Water Level Alarms:

- High and low water level alarms shall be tested **semiannually**.

Level Indicator:

- Level indicator shall be tested every **5 years** for accuracy and freedom of movement.

Pressure Gauges:

- Pressure gauges shall be tested every **5 years** with a calibrated gauge according the manufacturer's manual. Gauges not accurate to within 3 percent of the scale of gauge being tested shall be recalibrated or replaced.

Automatic Tank Fill Valve:

Automatic tank fill valve shall be tested **yearly** automatically by lowering the water level in the tank and the refill rate should be measured and recorded.

D. VALVE AND VALVE COMPONENT:

Main Drain Test:

- This test shall be conducted **annually** at each water-based fire protection system riser to determine whether there has been a change in the condition of the water supply.

Systems equipped with backflow prevention devices shall have a **quarterly** main drain test performed on at least 1 fire protection system riser to determine whether there has been a change in the condition of the water supply.

Water- Flow Alarms:

Mechanical water-flow devices, including but not limited to water motor gongs, shall be tested **quarterly**.

Vane-type and pressure switch-type waterflow devices shall be tested **semiannually**.

Control Valves:

- Each control valve shall be operated **annually** through its full range and returned to its normal position. This test shall be conducted every time the valve is closed.

Post indicator, curb valves and outside screw and yoke valves shall be backed one-quarter turn (90°) from the fully open position to prevent jamming.

- Valve **supervisory switches** shall be tested **semiannually**. A distinctive signal shall indicate movement from the valve's normal position during either the first two revolutions of a hand wheel or when the stem of the valve has moved no more than 1/5th of the distance from its normal position.

Preaction/ Deluge Valves:

- The **priming water level** in supervised preaction systems shall be tested **quarterly** in accordance with the manufacturer's instructions.
- **Low and high air pressure alarms** shall be tested **quarterly** in accordance with the manufacturer's instructions.
- Each deluge or preaction valve shall be trip tested **annually** at **full flow** in warm weather and in accordance with the manufacturer's instructions. Protection shall be provided for any devices subject to damage by system discharge during tests.

Pre-action systems shall be tested once every **3 years** for air leakage, using one of the two NFPA 25 (2011) required methods.

Dry Pipe Valves / Quick-Opening Devices:

- The priming water level shall be tested **quarterly**. High priming water levels can affect the operation of supervisory air or nitrogen pressure maintenance device. Testing the water level is done by opening the priming level test valve, if water flows, drain it, close the valve when water stops flowing and air discharges, if air discharges when the valve is opened, the priming water level could be too low. To add priming water, refer to manufacturer's instructions.
- Low and high air pressure alarms shall be tested **quarterly** in accordance with the manufacturer's instructions.

Dry pipe systems shall be tested once every 3 years for air leakage, using one of the two NFPA 25 (2011) required methods.

Quick-Opening Devices shall be tested **quarterly** following the below procedures:

- Close the system control valve, open the main drain valve and keep it in the open position, verify that the quick-opening device control valve is open. Open the inspector's test valve. A burst of air from device indicates that it has tripped. Close the device's control valve. Return the device to service in accordance with manufacturer's instructions and return the system to service.

Each dry pipe valve shall be **trip tested annually** during warm weather. Testing should be conducted in the spring to allow time for all water that has entered the system to drain to low points before the onset of cold weather.

- **Every 3 yrs** and whenever the system is altered, the dry pipe valve shall be trip tested with the control valve **fully open** and the quick – opening device in service.

- **A full flow trip test** - requires at least two individuals, one of whom is situated at the **dry pipe valve** while the other is at the **inspector's test**. If possible they should be in communication with each other. A full flow trip test is conducted as follows:
 1. The main drain valve is fully opened to clean any accumulated scale or foreign material from the supply water piping. The main drain valve then closed.
 2. The system air or nitrogen pressure and the supply water pressure are recorded.
 3. The system air or nitrogen pressure is relieved by opening the inspector's test valve completely. Concurrent with opening the valve, both testers start their stopwatches. If two-way communication is not available, the tester at the dry valve is to react to the start of downward movement on the air pressure gauge.
 4. Testers at the dry pipe valve note the air pressure at which the valve trips and note the tripping time.
 5. Testers at the inspector's test note the time at which water flows steadily from the test connection. This time is noted for comparison purposes to previous tests and is not meant to be a specific pass/fail criterion. Note that NFPA 13, does not require water delivery in 60 seconds for all systems.
 6. When clean water flows, the test is terminated by closing the system control valve.
 7. The air or nitrogen pressure and the time elapsed are to be recorded as follows:
 - a) from the complete opening of the test valve to the tripping of the valve,
 - b) from the complete opening of inspector's valve to the start of steady flow from the test connection.
 8. All low point drains are opened and then closed when water ceases to flow. The dry pipe valve and quick-opening are reset, if installed, in accordance with the manufacturer's instruction, and the system is returned to service.

Pressure Reducing and Relief Valves:

Sprinkler Systems:

- At 5 year intervals, a full flow test shall be conducted on pressure reducing valves and shall be compared to previous test result and the results from the original installation or acceptance test. Annually, a partial flow test shall be conducted with a flow rate great enough to lift the valve seat.

Circulation Relief:

- During the **annual** fire pump test, the closure of circulation relief valve shall be verified to be in accordance with the manufacturer's specifications.

Fire Pump Pressure Relief Valves:

- During the **annual** fire pump flow test, the pressure of relief valve shall be verified to be correctly adjusted and set to relieve at the correct pressure and to close below that pressure setting.

Sprinkler systems equipped with hose racks

- A full flow test shall be conducted on each valve at **5 years** intervals and shall be compared to previous test results.

Backflow Prevention Assemblies installed in fire protection system piping shall be tested annually in accordance with the following:

1. A forward flow test shall be conducted at the system demand, including hose stream demand, where hydrants or inside hose stations are located downstream of the backflow preventer.
2. A backflow performance test, as required by the authority having jurisdiction shall be conducted at the completion of the forward flow test.

12.5.3 MAINTENANCE

A. SPRINKLER SYSTEMS:

Obstruction Investigation:

- An internal investigation of piping and check valves shall be done every 5 years by opening a flushing connection at the end of one main and by removing a sprinkler toward the end of one branch line for the purpose of investigating for the presence of foreign organic and inorganic material.
- In buildings having multiple wet-pipe systems, every other system shall have an internal inspection of piping every 5 years as described in 14.2.1
- If an obstruction is found during the internal inspection all wet pipe systems shall have an internal inspection.

Low point drain (dry pipe system):

- Shall be drained each time the system is filled with water and before the onset of freezing weather conditions, and thereafter as needed.

Foam concentrate samples:

- Samples shall be submitted in accordance with the manufacturer's recommended sampling procedures.

B. FIRE BOOSTER AND SPECIAL SERVICE PUMPS:

- A preventive maintenance program shall be maintained on all components of the pump assembly in accordance with manufacturer's recommendations. If there is no manufacturer's recommendations for preventive maintenance use Tables 8.1.2 and 8.1.1.2 of NFPA 25, 2011.

Foam concentrate pump operation:

- The foam concentrate pump shall be operated.
- Foam concentrate shall be circulated back to the tank.

Foam concentrate pump(s):

- **Servicing:** Foam pumps, drive train, and drivers shall be serviced in accordance with the manufacturer's instructions and frequency but not at intervals of more than 5 years.

C. WATER STORAGE TANK:

Water Level:

- Tank shall be maintained full or at the designed water level.

Drain Silt

- Silt shall be removed during interior inspection as needed to avoid accumulation to the level of the tank outlet.

Embankment-Supported Coated Fabric (ESCF) Suction Tanks:

- The maintenance of ESCF tanks shall be done according the tank manufacturer manual.

Proportioning System(s) Standard Pressure Type:

- The foam liquid storage tank shall be drained of foam liquid and flushed.
- Foam liquid shall be permitted to be salvaged and reused.

BLADDER TANK TYPE**Foam Concentrate Tank-Hydrostatic Test:**

- The foam concentrate tank shall be hydrostatically tested to the specified working pressure.

LINE TYPE**Foam Concentrate Tank-Corrosion and Pickup Pipes:**

- The foam concentrate tank shall be inspected for internal corrosion.

Foam Concentrate Tank-Drain and Flush:

- Pickup pipes inside the tank shall be inspected for corrosion, separation, or plugging.

FOAM CONCENTRATE TANK**Corrosion and Sediment:**

- The foam concentrate tank shall be inspected internally for corrosion and sediment.
- Excessive sediment shall require draining and flushing of the tank.

D. VALVE AND VALVE COMPONENT:**Control Valves:**

- The operating stems of outside screw and yoke valves shall be lubricated **annually**. The valve then shall be completely closed and reopened to test its operation and distribute the lubricant.

Preaction/Deluge Valves

- During the annual trip test, the interior of the preaction or deluge valve shall be cleaned thoroughly and the parts replaced or repaired as necessary.
- Auxiliary drains in pre-action or deluge systems shall be operated after each system operation and before the onset of freezing conditions (and thereafter as needed).

Dry Pipe Valves / Quick – Opening Devices

- During the annual trip test, the interior of the dry valve or quick opening devices shall be cleaned thoroughly and the parts replaced or repaired as necessary.
- Auxiliary drains in pre-action or deluge systems shall be operated after each system operation and before the onset of freezing conditions (and thereafter as needed).

Proportioning system(s) standard pressure type:

- The ball drip (automatic type) drain valves shall be disassembled, cleaned, and reassembled.
- The foam liquid storage tank shall be drained of foam liquid and flushed.
- Foam liquid shall be permitted to be salvaged and reused.

Bladder tank type-Sight glass:

- Sight glass, where provided, shall be removed and cleaned.

Balancing valve diaphragm

- **Flushing:** The diaphragm balancing valve shall be flushed through the diaphragm section with water or foam concentrate until fluid appears clear or new.

PRESSURE VACUUM VENTS

The procedures specified below shall be performed on pressure vacuum vents every 5 years.

- The vent shall be removed from the expansion dome.
- The vent shall be checked to ensure that the opening is not blocked and that dirt or other foreign objects do not enter the tank.
- The vent bonnet shall be removed.
- The vacuum valve and pressure valve shall be lifted out.
- The vent body shall be flushed internally, and the vacuum valve and the pressure valve shall be washed thoroughly.
- The vent shall be checked to ensure that the screen is not clogged, and the use of any hard, pointed objects to clear the screen shall be avoided.
- If the liquid has become excessively gummy or solidified, the vent body and parts shall be soaked in hot soapy water.
- The vent body shall be turned upside down and drained thoroughly.
- Parts shall be dried by placing them in a warm and dry area or by using an air hose.
- Parts shall be sprayed with a light Teflon® coating, and the vent shall be reassembled.
- The use of any type of oil for lubrication purposes shall not be permitted.
- The vent bonnet shall be replaced, and the vent shall be turned upside down slowly a few times to ensure proper freedom of the movable parts.
- The vent shall be attached to the liquid storage tank

Foam concentrate strainer(s):

- Foam concentrate strainers shall be inspected visually to ensure the blow-down valve is closed and plugged.

Proportioning system(s):

- The components of the various proportioning systems described in this study material shall be inspected in accordance with the frequency specified in the tables below.
- Valves specified to be checked shall be permitted to be open or closed, depending on specific functions within each foam-water system.
- The position (open or closed) of valves shall be verified in accordance with specified operating conditions.
- Inspection of the concentrate tank shall include verification that the quantity of foam concentrate satisfies the requirements of the original design.
- Additional inspection requirements shall be performed as detailed for the proportioning systems as specified above.

Manual actuation device(s):

- Manual actuation devices shall be tested annually.

12.6 REFERENCE GUIDES DEFINING INDIVIDUALS QUALIFIED AS TO WHOM CAN PERFORM INSPECTION, TESTING AND MAINTENANCE FOR WATER BASED FIRE SUPPRESSION PIPING SYSTEM.

These check lists will be given to you by the FDNY examiners when taking this test at the Fire Department.

C of F	Certificate of Fitness for (S-12) or (S-15).			
Engineer	Refrigeration Operating Engineer (Q-01 or Q-99), NYC High Pressure Operating Engineer, NYS High Pressure Operating Engineer with S-12 C of F *(For employees of a single or multiple properties under common ownership employed by the same building owner/management company)			
MFSPC	Master Fire Suppression Piping Contractor License (A or B) with S-12 or S-15 C of F.			
MP	Master Plumber License (MP) with S-12 or S-15 C of F.			
¹ Limited to residential occupancies 30 sprinkler heads or less without booster pump. ² S-95 Supervision for Fire alarm Systems & other related systems. ³ Follow testing requirement. ⁴ Record must be maintained to be checked annually. ⁵ Must be performed once annually by licensed contractor. ⁶ The building owner shall ensure all water filled piping shall be maintained at a minimum of 40° degrees Fahrenheit. ** Water Spray Fixed Systems ONLY.				
Components		May be performed by		
		C of F	Engineer	MFSPC
I. INSPECTION				
A. Sprinkler Systems		Frequency		
WEEKLY (52)				
Gauge (dry,pre-action, deluge sys) non supervised	Yes	Yes	Yes	Yes
MONTHLY (12)				
Gauge (dry, pre-action, deluge sys) supervised	Yes	Yes	Yes	Yes
Gauge – wet pipe system	Yes	Yes	Yes	Yes
QUARTERLY (4)				
Waterflow alarm devices	Yes	Yes	Yes	Yes
Supervisory signal devices	Yes	Yes	Yes	Yes
Valve supervisory alarm device	Yes	Yes	Yes	Yes
Hydraulic name plate	Yes	Yes	Yes	Yes
Drainage**	Yes	Yes	Yes	Yes
Fittings**	Yes	Yes	Yes	Yes
Fittings (rubber-gasketed)**	Yes	Yes	Yes	Yes
ANNUALLY (1)				
Buildings – (prior to freezing weather) exterior of building should be examined to prevent freeze-ups fire suppression piping.	Yes ⁶	Yes ⁶	Yes ⁶	Yes ⁶
Hanger/seismic bracing	Yes	Yes	Yes	Yes
Pipe and fittings	Yes	Yes	Yes	Yes
Spare sprinkler heads/wrenches	Yes	Yes	Yes	Yes
Sprinkler heads	Yes	Yes	Yes	Yes
Heat tape	Yes	Yes	Yes	Yes
Information sign	Yes	Yes	Yes	Yes
Nozzles** (annually and after each system activation)	Yes	Yes	Yes	Yes
B. Fire, Booster and Special Service Pumps				
WEEKLY (52)				
Pump house, heating ventilating louvers	Yes	Yes	Yes	Yes

Pump suction and discharge and by-pass valves are fully open			Yes	Yes	Yes	Yes
Fire pump system			Yes	Yes	Yes	Yes
Diesel Engine Pump System	Fuel	Tank level	Yes	Yes	Yes	Yes
		Tank float switch				
		Solenoids valve operation				
		Water in the fuel sys				
		Flexible hoses and connectors				
		Piping				
	Lubrication system	Tank vents & overflow piping unobstructed				
		Oil level				
		Lube oil heater				
	Cooling system	Crankcase breather				
		Level				
		Adequate cooling water to heat exchanger				
		Water pumps				
	Exhaust system	Cond. of flexible hoses & connection				
		Jacket water heater				
Leakage						
Drain condensate trap						
Battery system	Hangers & supports					
	Flexible exhaust section					
Electric System	Electrolyte level					
	Voltage and current readings within an acceptable range					
MONTHLY (12)						
Diesel Engine System	Electric System	Circuit breakers or fuses	Yes	Yes	Yes	Yes
	Battery System	Equalize charge	Yes	Yes	Yes	Yes
		Corrosion on pump casing, clean and dry housing	Yes	Yes	Yes	Yes
QUARTERLY (4)						
Diesel Engine System	Exhaust system	Insulation & fire hazards	Yes	Yes	Yes	Yes
	Battery System	Terminals clean and tight				
	Electrical Motor Pump System	Wire chafing where subject to movement				
SEMIANNUALLY (2)						
Diesel Engine System	Electrical system	Operation of safeties and alarms	Yes	Yes	Yes	Yes
ANNUALLY (1)						
Fire pump system	Check accuracy of pressure gauges and sensors		Yes	Yes	Yes	Yes
	Check pump shaft endplay, coupling alignment					
	Wet pit suction screens					
Diesel Engine System	Cooling system	Inspect duct work, clean louvers (combustion air)	Yes	Yes	Yes	Yes
Electrical system ²	Inspect emergency manual starting means (without power)		Yes	Yes	Yes	Yes
	Check and tighten electrical connections as necessary					
	Check lubricate mechanical moving parts (excluding starters & relays)					
	Check and calibrate pressure switch settings					
C. Water Storage Tank						
DAILY (365)						

Heating System – without low temperature alarms (cold weather)		Yes	Yes	Yes	Yes
<u>WEEKLY (52)</u>					
Temperature alarms not connected to constantly connected location		Yes	Yes	Yes	Yes
Water temperature - with low temperature alarms NOT connected to a constantly attended location (heating season)		Yes	Yes	Yes	Yes
Heating system and components – with low temperature alarms (cold weather)		Yes	Yes	Yes	Yes
<u>MONTHLY (12)</u>					
Condition of water in tank – without water level alarms (cold weather)		Yes	Yes	Yes	Yes
Water temperature - with low temperature alarms connected to a constantly attended location (heating season)		Yes	Yes	Yes	Yes
Water - level (without water level alarms)		Yes	Yes	Yes	Yes
Air pressure - (without supervised air pressure source)		Yes	Yes	Yes	Yes
Temperature alarms connected to constantly attended location		Yes	Yes	Yes	Yes
<u>QUARTERLY (4)</u>					
Condition of water in tank - with water level temperature alarms (cold weather below 40°F)		Yes	Yes	Yes	Yes
Water – level (with supervised water level alarms)		Yes	Yes	Yes	Yes
Air pressure – (with supervised air pressure source)		Yes	Yes	Yes	Yes
Tank – exterior		Yes	Yes	Yes	Yes
Support structure		Yes	Yes	Yes	Yes
Catwalks and ladders		Yes	Yes	Yes	Yes
Surrounding area		Yes	Yes	Yes	Yes
<u>ANNUALLY (1)</u>					
Exterior (paint, coat or insulated surfaces)		Yes	Yes	Yes	Yes
Hoops and grillage of wooden tanks (AKA Dunnage)		Yes	Yes	Yes	Yes
Expansion Joints		Yes	Yes	Yes	Yes
<u>3 YEARS</u>					
Interior – (steel tanks without corrosion protection)		Yes	Yes	Yes	Yes
Pressure tanks		Yes	Yes	Yes	Yes
<u>5 YEARS</u>					
Interior - all other types of tanks		Yes	Yes	Yes	Yes
D. Valve and Valve Component					
<u>DAILY (365)</u>					
Pre-action valve and deluge valves - valve enclosure (during cold weather)		Yes	Yes	Yes	Yes
Dry pipe valves and quick opening devices – valve enclosure (during cold weather)		Yes	Yes	Yes	Yes
<u>WEEKLY (52)</u>					
Control Valves	Sealed	Yes	Yes	Yes	Yes
Pre-action valve and deluge valves - valve enclosure equipped with low temperature alarms (during cold weather)		Yes	Yes	Yes	Yes
Dry pipe valves and quick opening devices – valve enclosure equipped with low temperature alarms (during cold weather)		Yes	Yes	Yes	Yes
Gauges on systems (without low air or nitrogen pressure alarms)		Yes	Yes	Yes	Yes
Backflow Prevention assemblies (sealed valves)	Reduced pressure	Yes	Yes	Yes	Yes
	Reduced pressure detectors	Yes	Yes	Yes	Yes
Reduced pressure assembly (sealed valves)	(RPA or RPZ)	Yes	Yes	Yes	Yes
<u>MONTHLY (12)</u>					
Control Valves	Locked	Yes	Yes	Yes	Yes
	Tamper switches	Yes	Yes	Yes	Yes
Alarm valves		Exterior	Yes	Yes	Yes
Pressure reducing & Relief valves	Fire Pumps	Casing relief valves	Yes	Yes	Yes
		Pressure relief valves	Yes	Yes	Yes
Pre-action and deluge valves – Exterior			Yes	Yes	Yes
Dry pipe valves and quick opening devices – Exterior			Yes	Yes	Yes
Gauges on systems (other than with low air or nitrogen pressure alarms)			Yes	Yes	Yes

Backflow Prevention assemblies (secured with locks or electrically supervised)	reduced pressure	Yes	Yes	Yes	Yes
	reduced pressure detectors				
QUARTERLY (4)					
Pressure reducing & Relief valves	Sprinkler systems	Yes	Yes	Yes	Yes
Fire department connections		Yes	Yes	Yes	Yes
ANNUALLY (1)					
Pre-action and deluge valves - interior (when trip test is conducted- if no external reset)		No	No	Yes	No
Dry pipe valves and quick opening devices - interior (when trip test is conducted)		No	No	Yes	No
Check valves(Pre-action/deluge valves, dry pipe valves/quick-opening devices)		No	No	Yes	No
Pressure reducing & Relief valves	Hose Connections	Yes	Yes	Yes	Yes
	Hose Racks	Yes	Yes	Yes	Yes
5 YEARS					
Alarm valves	Interior	No	No	Yes	No
	Strainers, filters, orifices			Yes	No
Check Valves - Interior		No	No	Yes	No
Pre-action and deluge valves	Strainers, filters, orifices	No	No	Yes	No
Pre-action and deluge valves - interior (with external reset)		No	No	Yes	No
Dry pipe valves and quick opening devices	Strainers, filters, orifices	No	No	Yes	No

Reference Guide Defining Individuals Qualified as to Whom Can Perform Inspection, Testing and Maintenance for Water-Based Fire Suppression Piping System.

These Reference Guides will be given to you by the FDNY examiners when taking this test at the Fire Department.

C of F	Certificate of Fitness for (S-12) or (S-15).				
Engineer	Refrigeration Operating Engineer (Q-01 or Q-99), NYC High Pressure Operating Engineer, NYS High Pressure Operating Engineer with S-12 or S-15 C of F *(For employees of a single or multiple properties under common ownership employed by the same building owner/management company)				
MFSPC	Master Fire Suppression Piping Contractor License with S-12 C of F.				
MP	Master Plumber License (MP) with S-12 or S-15 C of F.				
¹ Limited to residential occupancies 30 sprinkler heads or less without booster pump. ² S-95 Supervision for Fire alarm Systems & other related systems. ³ Follow testing requirement. ⁴ Record must be maintained to be checked annually. ⁵ Must be performed once annually by licensed contractor. * Foam-Water Sprinkler Systems ONLY. ** Water Spray Fixed Systems ONLY.					
Components		May be performed by			
		C of F	Engineer	MFSPC * with S-15 COF only	MP¹
II. TEST					
A. Sprinkler Systems					
QUARTERLY (4)					
Alarm Devices	water motor gong	No	Yes	Yes	Yes ¹
Water Spray system test**		No	No	Yes	Yes
SEMIANNUALLY (2)					
Alarm Devices (Vane type water flow devices)		No	Yes	Yes	Yes ¹
Pressure Switch Type		No	Yes	Yes	Yes ¹
ANNUALLY (1)					
Antifreeze solution		No	No	Yes	Yes ¹
Flushing**		No	No	Yes	Yes
Complete foam-water system(s)*		No	No	Yes	Yes
Foam-water solution*		No	No	Yes	Yes
5 YEARS					
Gauges - Remove & send for calibration test or replace as required		No	Yes ⁴	Yes	Yes ¹
Sprinklers - Remove send for extra high temperature test and replace as required		No	No	Yes	Yes ¹
10 years & every 10 yrs thereafter					
Sprinklers - Dry type		No	No	Yes	Yes ¹
20 years & every 10 yrs thereafter					
Sprinklers - fast response and residential		No	No	Yes	Yes ¹
50 years & every 10 years after					
Sprinklers (Standard Response)		No	No	Yes	Yes ¹
B. Fire, Booster and Special Service Pumps					
WEEKLY (52)					
Pump operation - No-flow condition		No	Yes	Yes	Yes ¹
Diesel Engine system	tank float switch	No	Yes	Yes	Yes ¹

	Solenoids valve operation				
MONTHLY (1)					
Fire pump – Electric pump (minimum of 10 minutes)		No	Yes	Yes	Yes ¹
Electrical system ²	Isolating switch & circuit breaker	No	Yes ⁴	Yes	Yes ¹
Battery system	Specific gravity or state of charge				
SEMIANNUALLY (2)					
Electrical system ²	Operating manual starting means (electrical)	No	Yes ⁴	Yes	Yes ¹
Diesel Engine System	Cooling system	No	Yes ⁴	Yes	Yes ¹
	Fuel				
	Electrical system				
	Antifreeze protection level				
	Tank float switch				
	Solenoids valve operation				
	Operation of safeties and alarms				
ANNUALLY (1)					
Pump operation - Flow condition		No	No	Yes	No
Electrical system ²	Trip circuit breaker (if mechanism provided)	No	No	Yes	No
	Operate emergency manual starting means (without power)				
Exhaust system	Excessive back pressure	No	No	Yes	No
Diesel Engine System	Tank vents and overflow piping unobstructed	No	No	Yes	No
C. Water Storage Tank					
MONTHLY (12)					
Temperature alarms (cold weather)		No	Yes ⁵	Yes	Yes ¹
High temperature limit switches (cold weather)		No	Yes ⁵	Yes	Yes ¹
SEMIANNUALLY (2)					
Water level alarms		No	Yes ⁵	Yes	Yes ¹
5 YEARS					
Level indicators		No	No	Yes	Yes ¹
Pressure gauges		No	No	Yes	Yes ¹
D. Valve and Valve Component					
QUARTERLY (4)					
Main drain (sole water supply is through a backflow preventer and/or pressure reducing valves)		No	Yes ⁵	Yes	Yes ¹
Water-Flow Alarms (pertaining to dry valves, pre-action, and deluge valves)		No	Yes ⁵	Yes	Yes ¹
Foam concentrate strainer(s)*		No	No	Yes	Yes
Pre-action and deluge valves	Priming water	No	Yes ⁵	Yes	Yes ¹
	Low/high air pressure alarm				
Dry pipe valves and Quick Opening devices	Priming water	No	Yes ⁵	Yes	Yes ¹
	Low/high air pressure alarm				
	Quick-opening devices				
SEMIANNUALLY (2)					
Control Valves Tamper Switch	Supervisory Alarm	No	Yes ⁵	Yes	Yes ¹
Water flow alarms	Vane-type and pressure Switch-type water-flow devices	No	Yes ⁵	Yes	Yes ¹
ANNUALLY (1)					
Main drain		No	No	Yes	Yes ¹
Preaction and deluge valves	Full flow	No	No	Yes	Yes ¹

Dry pipe valves and Quick Opening devices	Trip test	No	No	Yes	Yes¹
Control Valves	Position	No	No	Yes	Yes¹
	Operation				
Pressure reducing and Relief valves	Circulation relief	No	No	Yes	Yes¹
	Pressure relief valves				
Backflow prevention Assemblies/Forward flow test		No	No	Yes	Yes¹
Proportioning system(s)-all*		No	No	Yes	Yes
Manual actuation device(s)*		No	No	Yes	Yes
Backflow preventer(s)*		No	No	Yes	Yes
<u>3 YEARS</u>					
Dry pipe valves and quick opening devices	Full flow trip test	No	No	Yes	Yes¹
Pre-action systems	For air leakage	No	No	Yes	Yes
<u>5 YEARS</u>					
Pressure reducing & Relief valves	Sprinkler systems	No	No	Yes	Yes¹
	Hose connections				
	Hose racks				

Reference Guide Defining Individuals Qualified as to Whom Can Perform Inspection, Testing and Maintenance for Water-Based Fire Suppression Piping System.

These Reference Guide will be given to you by the FDNY examiners when taking this test at the Fire Department.

C of F	Certificate of Fitness for (S-12) Citywide Sprinkler System.
Engineer	Refrigeration Operating Engineer (Q-01 or Q-99), NYC High Pressure Operating Engineer, NYS High Pressure Operating Engineer with S-12 C of F *(For employees of a single or multiple properties under common ownership employed by the same building owner/management company)
MFSPC	Master Fire Suppression Piping Contractor License with S-12 C of F.
MP	Master Plumber License (MP) with S-12 C of F.

¹ Limited to residential occupancies 30 sprinkler heads or less without booster pump.

² S-95 Supervision for Fire alarm Systems & other related systems.

³ Follow testing requirement.

⁴ Record must be maintained to be checked annually.

⁵ Must be performed once annually by licensed contractor.

* Foam-Water Sprinkler Systems ONLY.

Components	May be performed by			
	C of F	Engineer	MFSPC *with S-15 COF only	MP ¹

III. MAINTENANCE

A. Sprinkler Systems

ANNUALLY (1)

Valves (all types)	Control valves	No	No	Yes	Yes ¹
	Preaction/deluge	No	No	Yes	Yes ¹
	Dry pipe valves /quick opening devices			Yes	Yes ¹
Low point drains - (Dry pipe systems)	No	No	Yes	Yes ¹	
Foam concentrate samples*	No	No	Yes	Yes ¹	

5 YEARS

Internal Pipe Inspection	No	No	Yes	Yes ¹
--------------------------	----	----	-----	------------------

B. Fire, Booster and Special Service Pumps

WEEKLY (52)

Diesel engine system	Fuel	Clean water in the system	No	Yes ⁵	Yes	Yes ¹
----------------------	------	---------------------------	----	------------------	-----	------------------

MONTHLY (12)

Diesel engine system	Battery sys	Remove corrosion, case exterior	No	Yes ⁵	Yes	Yes ¹
Foam concentrate pump operation*			No	Yes ⁵	Yes	Yes ¹

QUARTERLY (4)

Diesel engine system	Fuel	Clean Strainer, filter or dirt leg or combination	No	Yes ⁵	Yes	Yes ¹
	Lubricating sys	Crankcase breather				
	Cooling sys	Water strainer				
	Battery sys	Remove corrosion, case exterior clean & dry				

SEMIANNUALLY (2)						
Diesel engine system	Electrical sys	Boxes, panels and cabinets	No	Yes ⁵	Yes	Yes ¹
		Circuit breakers or fuses				
ANNUALLY (1)						
Hydraulic			No	No	Yes	Yes ¹
Pump system	Lubricate pump bearings		No	No	Yes	Yes ¹
	Check accuracy of pressure gauges & sensors					
	Wet pit suction screens (after each pump opera.)					
Mechanical transmission	Lubricate coupling		No	No	Yes	Yes ¹
	Lubricate right angle gear drive					
Electrical system	Grease motor bearings		No	No	Yes	Yes ¹
Controller, various components			No	No	Yes	Yes ¹
Motor			No	No	Yes	Yes ¹
Diesel engine system various components	Cooling sys	Inspect duct work clean louvers	No	No	Yes	Yes ¹
		Rod out heat exchanger				
		Antifreeze				
	Lubrication sys	Oil change				
		Oil filters				
	Exhaust sys	Excessive back pressure				
EVERY 5 YEARS						
Standard balanced pressure type	Foam concentrate pump(s)* (also refer to manufacturer's instructions and frequency)		No	No	Yes	Yes ¹
In-line balanced pressure type	Foam concentrate pump(s)* (also refer to manufacturer's instructions and frequency)		No	No	Yes	Yes ¹
C. Water Storage Tank						
SEMIANNUALLY (2)						
Drain silt			No	Yes ⁵	Yes	Yes ¹
EVERY TWO (2) YEARS						
Embankment-supported coated fabric (ESCF) suction tanks			No	No	Yes	Yes ¹
EVERY 10 YEARS						
Bladder tank type	Foam concentrate tank-drain and flush*		No	No	Yes	Yes ¹
Corrosion and hydrostatic test*			No	No	Yes	Yes ¹
Foam concentrate tank – hydrostatic test*			No	No	Yes	Yes ¹
Foam concentrate tank-corrosion and pickup pipes*			No	No	Yes	Yes ¹
Line type	Foam concentrate tank-drain and flush*		No	No	Yes	Yes ¹
Standard balanced pressure type	Foam concentrate tank*		No	No	Yes	Yes ¹
In-line balanced pressure type	Foam concentrate tank*		No	No	Yes	Yes ¹
D. Valve and Valve Component						
ANNUALLY (1)						
Control valves			No	No	Yes	Yes ¹
Pre-action and Deluge Valves			No	No	Yes	Yes ¹
Dry Pipe Valves and Quick-Opening Devices			No	No	Yes	Yes ¹
Electrical release component for Pre-action /deluge system (i.e. smoke detectors) ²			No	No	Yes	Yes ¹
Foam concentrate samples*			No	No	Yes	Yes ¹

<u>5 YEARS</u>					
Ball drip (automatic type) drain valves*		No	No	Yes	Yes¹
Standard balanced pressure type	Balancing valve diaphragm*	No	No	Yes	Yes¹
In-line balanced pressure type	Balancing valve diaphragm*	No	No	Yes	Yes¹
Pressure vacuum vents*		No	No	Yes	Yes¹
<u>10 YEARS</u>					
Sight glass*		No	No	Yes	Yes¹

13. INSPECTION, TESTING & MAINTENANCE OF WATER BASED SYSTEMS INSPECTIONS ACTIVITIES AND RECORDS

Red Tag - Impairment	- Notify FDNY & owner immediately (Shall be fixed Immediately) FC 901.7
Orange Tag - Critical Deficiency	- Notify the owner immediately - If deficiency is not corrected after 30 days Notify FDNY
Yellow Tag - Non Critical Deficiency	- Notify the owner immediately - If deficiency is not corrected after 30 days Notify FDNY
Green Tag - Fully Operational	- System Fully operational

Components	Inspection Activities (Reference NFPA 25 – 2011)	Tag Color	Repair required?	If Yes, explain.
I. INSPECTION				
A. Sprinkler Systems				
Sprinkler system Shut down	Partial or Full shut down	Red	<input type="checkbox"/> Yes <input type="checkbox"/> No	
No Access	Control Valves - Inaccessible for more than 30 days	Red	<input type="checkbox"/> Yes <input type="checkbox"/> No	
Sprinklers	Leaking, heavily corroded, painted operating element or bulb or deflector or cover plate, heavily loaded foreign materials attached to or suspended from, improper orientation, glass bulbs that have lost fluid (5.2.1.1.1)	Red	<input type="checkbox"/> Yes <input type="checkbox"/> No	
Sprinklers	Lightly corroded, painted frame arm or boss, lightly loaded (5.2.1.1.1)	Orange	<input type="checkbox"/> Yes <input type="checkbox"/> No	
Sprinklers	Spray pattern obstructed – less than 18” below deflector (storage, signs, banner, etc) (5.2.1.2)	Orange	<input type="checkbox"/> Yes <input type="checkbox"/> No	
Sprinklers	Spray pattern obstructed – greater than 18” below deflector (ducts, decks, etc over 4” wide, overhead doors) (5.2.1.2)	Yellow	<input type="checkbox"/> Yes <input type="checkbox"/> No	
Spare sprinkler cabinet	Cabinet missing, temp, over 100°F, not proper number and type, missing wrench for each type (5.2.1.4 (1) and (2))	Yellow	<input type="checkbox"/> Yes <input type="checkbox"/> No	
Pipe and fittings	Leaking (5.2.2.1)	Red	<input type="checkbox"/> Yes <input type="checkbox"/> No	
Pipe and fittings	Poor condition/external corrosion, mechanical damage, not properly aligned, external loads (5.2.2.1, 5.2.2.2)	Yellow	<input type="checkbox"/> Yes <input type="checkbox"/> No	
Pipe and fittings	Subject to freezing conditions	Orange	<input type="checkbox"/> Yes <input type="checkbox"/> No	
Hangers & seismic braces	Damaged or loose (5.2.3.2)	Yellow	<input type="checkbox"/> Yes <input type="checkbox"/> No	
Gauges	Poor Condition (5.2.4.1)	Yellow	<input type="checkbox"/> Yes <input type="checkbox"/> No	

Gauges	Not showing normal water/air pressure (5.2.4.1, 5.2.4.2)	Yellow	<input type="checkbox"/> Yes <input type="checkbox"/> No	
Gauges	Freezer – system pressure lower than compressor (5.2.4.1)	Red	<input type="checkbox"/> Yes <input type="checkbox"/> No	
Building	Prior to freezing weather – exposed piping exposed to freezing (4.1.1.1)	Yellow	<input type="checkbox"/> Yes <input type="checkbox"/> No	
Building	Found during potential for freezing weather weather-exposed to freezing (4.1.1.1)	Orange	<input type="checkbox"/> Yes <input type="checkbox"/> No	
Alarm devices	Physical damage apparent (5.2.5)	Yellow	<input type="checkbox"/> Yes <input type="checkbox"/> No	
Hydraulic nameplate	Not legible or missing (5.2.6)	Yellow	<input type="checkbox"/> Yes <input type="checkbox"/> No	

B. Private Fire Service Mains

Exposed piping	Leaking (7.2.2.1.2)	Red	<input type="checkbox"/> Yes <input type="checkbox"/> No	
Exposed piping	Mechanical damage, corroded or not properly restrained (7.2.2.1.2)	Orange	<input type="checkbox"/> Yes <input type="checkbox"/> No	
Mainline strainers	Plugged or fouled (7.2.2.3)	Red	<input type="checkbox"/> Yes <input type="checkbox"/> No	
Mainline strainers	Corroded (7.2.2.3)	Orange	<input type="checkbox"/> Yes <input type="checkbox"/> No	
Dry barrel, wet barrel & wall hydrant	Inaccessible, barrel contains ice, cracks in barrel (7.2.2.4)	Red	<input type="checkbox"/> Yes <input type="checkbox"/> No	
Dry barrel, wet barrel & wall hydrant	Barrel contains water, improper drainage from barrel, leaks at outlets or top of hydrant (7.2.2.4)	Orange	<input type="checkbox"/> Yes <input type="checkbox"/> No	
Dry barrel, wet barrel & wall hydrant	Tightness of outlets, worn nozzle threads, worn operating nut, missing wrench (7.2.2.4)	Yellow	<input type="checkbox"/> Yes <input type="checkbox"/> No	
Monitor nozzles	Damaged, corroded or leaking (7.2.2.6)	Orange	<input type="checkbox"/> Yes <input type="checkbox"/> No	
Hose/hydrant houses	Inaccessible (7.2.2.7)	Red	<input type="checkbox"/> Yes <input type="checkbox"/> No	
Hose/hydrant houses	Damaged (7.2.2.7)	Orange	<input type="checkbox"/> Yes <input type="checkbox"/> No	
Hose/hydrant houses	Not fully equipped (7.2.2.7)	Orange	<input type="checkbox"/> Yes <input type="checkbox"/> No	

C. Fire, Booster and Special Service Pumps

Pump house/room	Heat not adequate, temp. less than 40 (less than 70 for diesel pumps without engine heaters) (8.2.2)	Orange	<input type="checkbox"/> Yes <input type="checkbox"/> No	
Pump house/room	Ventilating louvers not free to operate (8.2.2)	Orange	<input type="checkbox"/> Yes <input type="checkbox"/> No	
Pump system	Suction, discharge or bypass valves not fully open, pipe leaking, suction line & system line pressure not normal, wet pit suction screens obstructed (8.2.2)	Red	<input type="checkbox"/> Yes <input type="checkbox"/> No	
Pump system	Suction reservoir not full, wet pit suction screens	Orange	<input type="checkbox"/> Yes <input type="checkbox"/> No	

	missing (8.2.2)			
Electrical system	No electrical power - controller pilot light not illuminated, transfer switch pilot light not illuminated, isolating switch not closed, reverse phase alarm pilot light on or normal phase light is off, oil level in vertical motor sight glass not normal, power to pressure maintenance (jockey) pump is not provided. (8.2.2)	Red	<input type="checkbox"/> Yes <input type="checkbox"/> No	
Electrical system	Circuit breakers and fuses over two years old (8.2.2)	Orange	<input type="checkbox"/> Yes <input type="checkbox"/> No	
Electrical system	Electrical power is provided – controller pilot light not illuminated, transfer switch pilot light not illuminated, reverse phase alarm pilot light on or normal phase light is not illuminated (8.2.2)	Yellow	<input type="checkbox"/> Yes <input type="checkbox"/> No	
Diesel engine system	Fuel tank less than two-thirds full, controller selector switch not in auto position, battery voltage readings not normal, battery charging current not normal, battery pilot lights off or battery failure pilot lights on alarm pilot lights are on, engine running time meter not reading, oil level in right angle gear drive not normal, crankcase oil level not normal, cooling water level not normal, electrolyte level in batteries not normal, battery terminals corroded, water-jacket heater not operating (8.2.2)	Orange	<input type="checkbox"/> Yes <input type="checkbox"/> No	
Steam System	Steam pressure gauge reading not normal (8.2.2)	Orange	<input type="checkbox"/> Yes <input type="checkbox"/> No	
D. Water Storage Tanks				
Water level	Water level and /or condition not correct (9.2.1)	Orange	<input type="checkbox"/> Yes <input type="checkbox"/> No	
Air pressure	Air pressure in pressure tanks not correct (9.2.2)	Red	<input type="checkbox"/> Yes <input type="checkbox"/> No	
Heating system	Heating system not operational, water temperature below 40 (9.2.3)	Orange	<input type="checkbox"/> Yes <input type="checkbox"/> No	
Exterior	Tank exterior, supporting structure, vents,	Yellow	<input type="checkbox"/> Yes <input type="checkbox"/> No	

	foundation, catwalks or ladders where provided damaged (9.2.5.1)			
Exterior	Area around tank has fire exposure hazard in form of combustible storage, trash, debris, brush or material (9.2.5.2)	Yellow	<input type="checkbox"/> Yes <input type="checkbox"/> No	
Exterior	Accumulation of material on or near parts that could result in accelerated corrosion or rot (9.2.5.2)	Yellow	<input type="checkbox"/> Yes <input type="checkbox"/> No	
Exterior	Ice buildup on tank and support (9.2.5.2)	Orange	<input type="checkbox"/> Yes <input type="checkbox"/> No	
Exterior	Erosion exists on exterior sides or top of embankments supporting coated fabric tanks (9.2.5.2)	Yellow	<input type="checkbox"/> Yes <input type="checkbox"/> No	
Exterior	Expansion joints leaking or cracking (9.2.5.3)	Orange	<input type="checkbox"/> Yes <input type="checkbox"/> No	
Exterior	Hoops and grills of wooden tanks in poor condition (9.2.5.4)	Yellow	<input type="checkbox"/> Yes <input type="checkbox"/> No	
Exterior	Exterior painted, coated, or insulated surfaces of tanks or supporting structure degraded (9.2.5.5)	Yellow	<input type="checkbox"/> Yes <input type="checkbox"/> No	
Interior (pressure tanks or steel tanks w/o corrosion protection every 3 years, all others every 5 years)	Pitting, corrosion, spalling, rot other forms of deterioration, waste materials exist, aquatic growth, local or general failure of interior coating (9.2.6.3)	Yellow	<input type="checkbox"/> Yes <input type="checkbox"/> No	
Interior (pressure tanks or steel tanks w/o corrosion protection every 3 years, all others every 5 years)	voids beneath floor with sand in the middle of tanks on ring type foundations (9.2.6.5)	Yellow	<input type="checkbox"/> Yes <input type="checkbox"/> No	
Interior (pressure tanks or steel tanks w/o corrosion protection every 3 years, all others every 5 years)	Heating system components or piping in poor condition (9.2.6.6)	Yellow	<input type="checkbox"/> Yes <input type="checkbox"/> No	
Interior (pressure tanks or steel tanks w/o corrosion protection every 3 years, all others every 5 years)	Blockage of anti-vortex plate (9.2.6.7)	Red	<input type="checkbox"/> Yes <input type="checkbox"/> No	
Interior (pressure tanks or steel tanks w/o corrosion protection every 3 years, all others every 5 years)	Deterioration of anti-vortex plate (9.2.6.7)	Orange	<input type="checkbox"/> Yes <input type="checkbox"/> No	

every 5 years)				
E. Water Spray Fixed Systems				
Pipe and Fittings	Mechanical damage, missing or damaged paint or coating, rusted or corroded, not properly aligned or trapped sections, low point drains not functioning, improper location of rubber-gasketed fittings (10.2.4.1)	Orange	<input type="checkbox"/> Yes <input type="checkbox"/> No	
Hangers & seismic braces	Damaged or missing, not securely attached to structural or piping, missing or damaged paint or coating, rusted or corroded (10.2.4.2)	Yellow	<input type="checkbox"/> Yes <input type="checkbox"/> No	
Water spray nozzles	Discharge devices missing, not properly positioned or pointed in design direction, loaded or corroded (10.2.5.1)	Orange	<input type="checkbox"/> Yes <input type="checkbox"/> No	
Water spray nozzles	Missing caps or plugs if required or not free to operate as intended (10.2.5.2)	Orange	<input type="checkbox"/> Yes <input type="checkbox"/> No	
Strainers	Strainer plugged or doubled (10.2.7)	Red	<input type="checkbox"/> Yes <input type="checkbox"/> No	
Strainers	Strainer damaged or corroded (10.2.7)	Yellow	<input type="checkbox"/> Yes <input type="checkbox"/> No	
Drainage	Trap sumps and drainage trenches blocked, retention embankments or dikes in disrepair (10.2.8)	Yellow	<input type="checkbox"/> Yes <input type="checkbox"/> No	
Ultra-High-Speed	Detectors have physical damage or deposits on lenses of optical detectors (10.4.2)	Orange	<input type="checkbox"/> Yes <input type="checkbox"/> No	
Ultra-High-Speed	Controllers found to have faults (10.4.3)	Orange	<input type="checkbox"/> Yes <input type="checkbox"/> No	
F. Foam-Water Sprinkler Systems				
Alarm devices	Physical damage apparent (11.1.3.1)	Yellow	<input type="checkbox"/> Yes <input type="checkbox"/> No	
Pipe and fittings	Mechanical damage, missing or damaged paint or coating, rusted or corroded, not properly aligned or trapped sections, low point drains not functioning, improper location or poor condition or rubber-gasketed fittings (11.2.3)	Orange	<input type="checkbox"/> Yes <input type="checkbox"/> No	
Hangers & seismic braces	Damaged or missing, not securely attached to structural or piping, missing or damaged paint or coating, rusted or	Yellow	<input type="checkbox"/> Yes <input type="checkbox"/> No	

	corroded (11.2.4)			
Foam-water discharge devices	Discharge devices missing, not properly positioned or pointed in design direction, loaded or corroded (11.2.5.1)	Orange	<input type="checkbox"/> Yes <input type="checkbox"/> No	
Foam-water discharge devices	Not free to operate as intended (11.2.5.2)	Orange	<input type="checkbox"/> Yes <input type="checkbox"/> No	
Foam-water discharge devices	Missing caps or plugs if required (11.2.5.2)	Yellow	<input type="checkbox"/> Yes <input type="checkbox"/> No	
Foam-water discharge devices	Discharge devices not listed for use with foam concentrate (11.2.5.4)	Orange	<input type="checkbox"/> Yes <input type="checkbox"/> No	
Foam Concentrate strainers	Blow-down vane open or not plugged (11.2.7.2)	Orange	<input type="checkbox"/> Yes <input type="checkbox"/> No	
Drainage	Trap sumps and drainage trenches blocked, retention embankments or dikes in disrepair (11.2.8)	Yellow	<input type="checkbox"/> Yes <input type="checkbox"/> No	
Proportioning systems (all)	Proportioning system valves not in correct open/closed position in accordance with specified operating conditions (11.2.9.3)	Red	<input type="checkbox"/> Yes <input type="checkbox"/> No	
Proportioning systems (all)	Concentrate tank does not have correct quantity required by original design (11.2.9.4)	Orange	<input type="checkbox"/> Yes <input type="checkbox"/> No	
Standard pressure proportioner	Automatic drains (ball drip valves) not free or open, external corrosion on foam concentrate tanks (11.2.9.5.1)	Yellow	<input type="checkbox"/> Yes <input type="checkbox"/> No	
Bladder tank proportioned	Water control valve to foam concentrate in “closed” position (11.2.9.5.2)	Red	<input type="checkbox"/> Yes <input type="checkbox"/> No	
Bladder tank proportioned	Foam in water surrounding bladder (11.2.9.5.2)	Orange	<input type="checkbox"/> Yes <input type="checkbox"/> No	
Bladder tank proportioned	External corrosion on foam concentrate tank (11.2.9.5.2)	Yellow	<input type="checkbox"/> Yes <input type="checkbox"/> No	
Line proportioner	Strainer damaged, corroded, plugged or fouled, pressure vacuum vent not operating freely (11.2.9.5.3)	Orange	<input type="checkbox"/> Yes <input type="checkbox"/> No	
Line proportioner	External corrosion on foam concentrate tank (11.2.9.5.3)	Yellow	<input type="checkbox"/> Yes <input type="checkbox"/> No	
Standard balanced pressure proportioner	Sensing line valves not open, no power to foam liquid pump (11.2.9.5.4)	Red	<input type="checkbox"/> Yes <input type="checkbox"/> No	
Standard balanced pressure proportioner	Strainer damaged, corroded, plugged or fouled, pressure vacuum vent not operating freely, gauges damaged or not showing proper pressures (11.2.9.5.3)	Orange	<input type="checkbox"/> Yes <input type="checkbox"/> No	

In-Line balanced pressure proportioner	Sensing line valves at pump unit or individual proportioner stations not open, no power to foam liquid pump (11.2.9.5.4)	Red	<input type="checkbox"/> Yes <input type="checkbox"/> No	
In-Line balanced pressure proportioner	Strainer damaged, corroded, plugged or fouled, pressure vacuum vent not operating freely, gauges damaged or not showing proper pressures (11.2.9.5.5)	Orange	<input type="checkbox"/> Yes <input type="checkbox"/> No	
Orifice plate proportioner	No power to foam liquid pump (11.2.9.5.6)	Red	<input type="checkbox"/> Yes <input type="checkbox"/> No	
Orifice plate proportioner	Strainer damaged, corroded, plugged or fouled, pressure vacuum vent not operating freely, gauges damaged or not showing proper pressures (11.2.9.5.6)	Orange	<input type="checkbox"/> Yes <input type="checkbox"/> No	
Foam concentrate	Samples not taken and submitted for test (11.2.10)	Orange	<input type="checkbox"/> Yes <input type="checkbox"/> No	
G. Valves, Valve components, and Trim				
Gauges	Poor condition (13.2.7.1, 12.2.8.1)	Yellow	<input type="checkbox"/> Yes <input type="checkbox"/> No	
Gauges	Not showing normal water/air pressure 13.2.7.1, 12.2.8.1)	Orange	<input type="checkbox"/> Yes <input type="checkbox"/> No	
Control valve	Improper closed position (13.3.2.2, 12.3.2.2)	Red	<input type="checkbox"/> Yes <input type="checkbox"/> No	
Control valve	Improper open position, leaking (13.3.2.2, 12.3.2.2)	Orange	<input type="checkbox"/> Yes <input type="checkbox"/> No	
Control valve	Not sealed, locked or supervised, not accessible, no appropriated wrench if required, and no identification (13.3.2.2, 12.3.2.2)	Yellow	<input type="checkbox"/> Yes <input type="checkbox"/> No	
Alarm valve	External physical damage, trim valves not in appropriate open or closed position, retard chamber or alarm drain leaking (12.4.1.1)	Orange	<input type="checkbox"/> Yes <input type="checkbox"/> No	
Alarm valve	Alarm valve, strainers, filters and restricted orifices not internally inspected after 5 years (12.4.1.2)	Orange	<input type="checkbox"/> Yes <input type="checkbox"/> No	
Check valve	Check valve not internally inspected after 5 years (12.4.2.1)	Orange	<input type="checkbox"/> Yes <input type="checkbox"/> No	
Valve enclosure	Not maintaining minimum 40°F temp (12.4.3.1.1, 12.4.4.1.1)	Orange	<input type="checkbox"/> Yes <input type="checkbox"/> No	
Preaction valve and deluge valve	External physical damage, trim valves not in appropriate open or closed position, valve seat	Orange	<input type="checkbox"/> Yes <input type="checkbox"/> No	

	leaking (12.4.3.1.6)			
Preaction valve and deluge valve	Electrical components not in service (12.4.3.1.6)	Red	<input type="checkbox"/> Yes <input type="checkbox"/> No	
Preaction valve and deluge valve	Interior of preaction valve/or deluge valve, strainers, filters, restricted orifices, and diaphragm chambers not internally inspected after 5 years (12.4.3.1.8)	Orange	<input type="checkbox"/> Yes <input type="checkbox"/> No	
Dry pipe valve/quick opening device	External physical damage, trim valves not in appropriate open or closed position, intermediate chamber leaking (12.4.4.1.6)	Orange	<input type="checkbox"/> Yes <input type="checkbox"/> No	
Dry pipe valve/quick opening device	Dry pipe valve, strainers, filters and restricted orifices not internally inspected after 5 years (12.4.4.1.6)	Orange	<input type="checkbox"/> Yes <input type="checkbox"/> No	
Sprinkler pressure reducing control valves	Not in open position, not maintaining down-stream pressures in accordance with the design criteria (12.5.1.1)	Red	<input type="checkbox"/> Yes <input type="checkbox"/> No	
FDNY 5 year test not conducted	As per Chapter 9 NYC Fire Code	Orange	<input type="checkbox"/> Yes <input type="checkbox"/> No	
Sprinkler pressure reducing control valves	leaking, valve damaged, hand wheel missing or broken (12.5.3.1)	Orange	<input type="checkbox"/> Yes <input type="checkbox"/> No	
Hose valves	Leaking, visible obstructions, caps, hose threads, valve handle, cap gasket, no restricting device, damaged or in poor condition (12.5.5.1)	Orange	<input type="checkbox"/> Yes <input type="checkbox"/> No	
Preaction valves/ and deluge valve	Annual partial flow test results not available (12.5.1.3)	Orange	<input type="checkbox"/> Yes <input type="checkbox"/> No	
Backflow prevention assemblies	Reduced pressure assemblies differential-sensing valve relief port continuously discharging (12.6.1.2)	Orange	<input type="checkbox"/> Yes <input type="checkbox"/> No	
Fire Department connection	Not accessible, couplings & swivels damaged, do not rotate smoothly, clapper not operating properly or missing (12.7.1)	Red	<input type="checkbox"/> Yes <input type="checkbox"/> No	
Fire Department connection	Not visible, couplings & swivels do not rotate smoothly, plugs & caps or gaskets damaged or missing, check valve leaking, automatic drain not operating properly or missing (12.7.1)	Orange	<input type="checkbox"/> Yes <input type="checkbox"/> No	
Fire department connection	Missing identification sign (12.7.1)	Yellow	<input type="checkbox"/> Yes <input type="checkbox"/> No	

II. TEST				
A. Sprinkler Systems				
Sprinklers – Standard	No test after 50 years, every 10 years thereafter (5.3.1.1.1)	Yellow	<input type="checkbox"/> Yes <input type="checkbox"/> No	
Sprinklers – standard	prior to 1920 not replaced (5.3.1.1.1.1)	Orange	<input type="checkbox"/> Yes <input type="checkbox"/> No	
Sprinklers – fast response	No test after 20 years, every 10 years thereafter (5.3.1.1.1.2)	Yellow	<input type="checkbox"/> Yes <input type="checkbox"/> No	
Sprinklers – solder-type 325 or greater	No test after 5 years, every 5 years thereafter (5.3.1.1.1.3)	Yellow	<input type="checkbox"/> Yes <input type="checkbox"/> No	
Sprinklers- standard	No test after 75 years, every 5 years thereafter (5.3.1.1.1.4)	Yellow	<input type="checkbox"/> Yes <input type="checkbox"/> No	
Sprinklers – dry type	No test after 10 years, every 10 years thereafter (5.3.1.1.1.5)	Orange	<input type="checkbox"/> Yes <input type="checkbox"/> No	
Sprinklers – subject to harsh environments	(Corrosive atmospheres, corrosive water supply, includes freezers and coolers) No test after 5 years, every 5 years thereafter (5.3.1.1.2)	Yellow	<input type="checkbox"/> Yes <input type="checkbox"/> No	
Sprinklers – solder type	(Commercial-type cooking equipment. & ventilating systems) No replacement after one year (5.4.1.9)	Orange	<input type="checkbox"/> Yes <input type="checkbox"/> No	
Sprinklers in spray coating areas	Plastic or paper bags used to protect against overspray residue, with deposits or residue accumulation (5.4.1.7.1, 5.4.1.7.2)	Red	<input type="checkbox"/> Yes <input type="checkbox"/> No	
Gauges	Not replaced or calibrated in 5 years, not accurate within 3% of scale (5.3.2)	Yellow	<input type="checkbox"/> Yes <input type="checkbox"/> No	
Alarm devices	Water motor and gong not functioning (5.3.3)	Orange	<input type="checkbox"/> Yes <input type="checkbox"/> No	
Alarm devices	Pressure switch or vane type switch not functioning or no alarm (5.3.4)	Orange	<input type="checkbox"/> Yes <input type="checkbox"/> No	
Antifreeze systems	Specific gravity of antifreeze not correct (5.3.2)	Orange	<input type="checkbox"/> Yes <input type="checkbox"/> No	
Main drain	Large drop in full flow pressure or slow return to normal static pressure. (10.3.7.1)	Red	<input type="checkbox"/> Yes <input type="checkbox"/> No	
Obstruction Investigation	No inspection of main and branch line after 5 years or inspection revealed presence of MIC, zebra mussels, rust and scale (14.2.1)	Orange	<input type="checkbox"/> Yes <input type="checkbox"/> No	

B. Private Fire Service Mains				
Underground and exposed piping	No flow test done after 5 years or test results not comparable to previous (7.3.1)	Yellow	<input type="checkbox"/> Yes <input type="checkbox"/> No	
Dry barrel & wall hydrant	Hydrant did not flow clear or did not drain within 60 minutes (7.3.2.1, 7.3.2.4)	Yellow	<input type="checkbox"/> Yes <input type="checkbox"/> No	
Monitor nozzles	Did not flow acceptable amount of water or did not operate throughout their full range (7.3.3.1, 7.3.3.2)	Orange	<input type="checkbox"/> Yes <input type="checkbox"/> No	
C. Fire, Booster and Special Service Pumps				
Fire pump weekly test	Pump did not start automatically, electric pump did not run 10 minutes, diesel pump did not run 30 minutes (8.3.1)	Red	<input type="checkbox"/> Yes <input type="checkbox"/> No	
Fire pump weekly test – pump system	System suction and discharge gauge reading, or pump starting pressure not acceptable (8.3.2.2)	Red	<input type="checkbox"/> Yes <input type="checkbox"/> No	
Fire pump weekly test – pump system	Pump packing gland discharge not acceptable, unusual noise or vibration, packing boxes, bearings or pump casing overheating (8.3.2.2)	Orange	<input type="checkbox"/> Yes <input type="checkbox"/> No	
Fire pump weekly test – electrical system	Time for motor to accelerate to full speed, time controller is on first step or time pump runs after starting not acceptable (8.3.2.2)	Red	<input type="checkbox"/> Yes <input type="checkbox"/> No	
Fire pump weekly test – diesel engine system	Time for engine to crank and time for engine to reach running speed not acceptable, low rpm, low oil pressure, high temperature, high cooling water pressure (8.3.2)	Orange	<input type="checkbox"/> Yes <input type="checkbox"/> No	
Fire pump weekly test- steam system	Gauge reading and time for turbine to reach running speed not acceptable (8.3.2)	Red	<input type="checkbox"/> Yes <input type="checkbox"/> No	
Fire pump annual test	Churn condition not maintained for 30 minutes, circulation relief valve and /or pressure relief valve (8.3.3.2)	Orange	<input type="checkbox"/> Yes <input type="checkbox"/> No	
Fire pump annual test	Pressure relief valve did not work properly at each flow condition (8.3.3.3)	Orange	<input type="checkbox"/> Yes <input type="checkbox"/> No	
Fire pump annual test (with transfer switch)	Over current protective devices opened when simulating a power failure condition at peak load,	Red	<input type="checkbox"/> Yes <input type="checkbox"/> No	

	power not transferred to alternate source, pump did not continue to perform at peak load, pump did not reconnect to normal power after removing power failure condition (8.3.3.4)			
Fire pump annual test	Alarms did not properly operate (8.3.3.5)	Yellow	<input type="checkbox"/> Yes <input type="checkbox"/> No	
Pump house/room	Heating lighting, ventilating systems did not pass test (8.3.4.3)	Orange	<input type="checkbox"/> Yes <input type="checkbox"/> No	
Fire pump annual test	Parallel or angular alignment was not correct (8.3.4.4)	Orange	<input type="checkbox"/> Yes <input type="checkbox"/> No	
Fire pump annual test	Flow test results are not with 5% of acceptance test or name plate (8.3.5.4)	Orange	<input type="checkbox"/> Yes <input type="checkbox"/> No	
Fire pump annual test	Voltage readings at the motor are not within 5 % below or 10% above the rated (name-plate) (8.3.5.6)	Orange	<input type="checkbox"/> Yes <input type="checkbox"/> No	
D. Water Storage Tanks				
Interior testing	Tank coating did not pass adhesion, coating thickness or wet sponge test (9.2.7)	Yellow	<input type="checkbox"/> Yes <input type="checkbox"/> No	
Interior testing	Tank walls and bottom did not pass ultrasonic test (9.2.7)	Yellow	<input type="checkbox"/> Yes <input type="checkbox"/> No	
Interior testing	Tank bottom seams did not pass vacuum box test (9.2.7)	Yellow	<input type="checkbox"/> Yes <input type="checkbox"/> No	
Testing	Level indicator not tested after 5 years, lacked freedom of movement or not accurate (9.3.1)	Yellow	<input type="checkbox"/> Yes <input type="checkbox"/> No	
Testing	Low water temperature alarm did not pass test (9.3.3)	Yellow	<input type="checkbox"/> Yes <input type="checkbox"/> No	
Testing	High water temperature limit switch did not pass test (9.3.4)	Yellow	<input type="checkbox"/> Yes <input type="checkbox"/> No	
Testing	High and low water level alarms did not pass test (9.3.5)	Red	<input type="checkbox"/> Yes <input type="checkbox"/> No	
Gauges	Not tested in 5 years, not accurate within 3% of scale (9.3.6)	Yellow	<input type="checkbox"/> Yes <input type="checkbox"/> No	
E. Water Spray Fixed Systems				
Operational test	Heat detection system did not operate within 40 seconds, flammable gas detection system did not operate within 20 seconds (10.3.4.1.1)	Orange	<input type="checkbox"/> Yes <input type="checkbox"/> No	
Operational test	Test not done after 1 year (10.3.1.1)	Yellow	<input type="checkbox"/> Yes <input type="checkbox"/> No	

Operational test	Nozzles are plugged (10.3.4.3.1)	Red	<input type="checkbox"/> Yes <input type="checkbox"/> No	
Operational test	Nozzles are not correctly positioned (10.3.4.3.1)	Orange	<input type="checkbox"/> Yes <input type="checkbox"/> No	
Operational test	Pressure readings are not comparable to original design requirements (10.3.4.4)	Orange	<input type="checkbox"/> Yes <input type="checkbox"/> No	
Operation test	Manual actuation devices did not work properly (10.3.6)	Red	<input type="checkbox"/> Yes <input type="checkbox"/> No	
Main drain	Large drop in full flow pressure or slow return to normal static pressure (10.3.7.1)	Red	<input type="checkbox"/> Yes <input type="checkbox"/> No	
Ultra-High-Speed operational test	Response time was more than 100 milliseconds (10.4.5)	Red	<input type="checkbox"/> Yes <input type="checkbox"/> No	
Ultra-High-Speed operational test	Test not done after (10.4.5)	Yellow	<input type="checkbox"/> Yes <input type="checkbox"/> No	
F. Foam-Water Sprinkler Systems				
Alarm devices	Water motor and gong not functioning (11.1.3.1.1, 11.3.1.1)	Orange	<input type="checkbox"/> Yes <input type="checkbox"/> No	
Alarm devices	Pressure switch or van type switch not functioning or no alarm (11.1.3.1.2, 11.3.1.2)	Orange	<input type="checkbox"/> Yes <input type="checkbox"/> No	
Operational Test	Fire detection system did not operate within requirements of NFPA #72 (11.3.2.4)	Orange	<input type="checkbox"/> Yes <input type="checkbox"/> No	
Operational Test	Test not done after 1 year (11.3)	Yellow	<input type="checkbox"/> Yes <input type="checkbox"/> No	
Operational Test	Nozzles are plugged (11.3.2.6.1)	Red	<input type="checkbox"/> Yes <input type="checkbox"/> No	
Operational Test	Nozzles are not correctly positioned (11.3.2.6.1)	Orange	<input type="checkbox"/> Yes <input type="checkbox"/> No	
Operational Test	Pressure readings are not comparable to original design requirements (11.3.2.7.3)	Orange	<input type="checkbox"/> Yes <input type="checkbox"/> No	
Operational Test	Manual actuation devices did not work properly (11.3.4)	Red	<input type="checkbox"/> Yes <input type="checkbox"/> No	
Operational Test	Foam sample did not pass concentration test (11.3.5)	Red	<input type="checkbox"/> Yes <input type="checkbox"/> No	
Main drain	Large drop in full flow pressure or slow return to normal static pressure (10.3.7.1)	Red	<input type="checkbox"/> Yes <input type="checkbox"/> No	
Obstruction Investigation	No inspection of main and branch line after 5 years or inspection revealed presence of MIC, zebra mussels, rust and scale (14.2.1)	Orange	<input type="checkbox"/> Yes <input type="checkbox"/> No	

G. Valves, Valve components, and Trim				
Alarm devices	Water motor and gong not functioning (12.2.7)	Orange	<input type="checkbox"/> Yes <input type="checkbox"/> No	
Alarm devices	Pressure switch or vane type switch not functioning or no alarm (12.2.7)	Orange	<input type="checkbox"/> Yes <input type="checkbox"/> No	
Gauges	not replaced or calibrated in 5 years, not accurate within 3% of scale (12.2.8.1 – 12.2.8.3)	Yellow	<input type="checkbox"/> Yes <input type="checkbox"/> No	
Control valve	Valve will not operate through its full range (12.3.3.1)	Orange	<input type="checkbox"/> Yes <input type="checkbox"/> No	
Control valve	No spring or Torsion felt in rod when opening post indicator valve (12.3.3.2)	Red	<input type="checkbox"/> Yes <input type="checkbox"/> No	
Supervisory switches	No signal from two revolutions of the hand wheel from normal position or when stem has moved 1/5 of the distance from normal position, signal restored in position other than normal (12.3.3.5.2)	Yellow	<input type="checkbox"/> Yes <input type="checkbox"/> No	
Preaction valve	Priming water level not correct (12.4.3.2.1)	Orange	<input type="checkbox"/> Yes <input type="checkbox"/> No	
Deluge valve	Annual full flow trip test revealed plugged nozzles, pressure reading at hydraulically most remote nozzle and/or at valve not comparable to original design values, manual actuation devices did not operate properly (12.4.2.2.3)	Red	<input type="checkbox"/> Yes <input type="checkbox"/> No	
Preaction Valve	Low air pressure switch did not send signal or no alarm (12.4.3.2.10)	Yellow	<input type="checkbox"/> Yes <input type="checkbox"/> No	
Preaction and deluge valve	Low temperature switch did not send signal or and alarm (12.4.3.2.11)	Yellow	<input type="checkbox"/> Yes <input type="checkbox"/> No	
Preaction valve	Automatic air maintenance device did not pass test (12.4.3.2.12)	Yellow	<input type="checkbox"/> Yes <input type="checkbox"/> No	
Dry pipe valve	priming water level not correct (12.4.4.2.1)	Orange	<input type="checkbox"/> Yes <input type="checkbox"/> No	
Dry pipe valve	Annual trip test results were not comparable to previous tests (12.4.4.2.2)	Yellow	<input type="checkbox"/> Yes <input type="checkbox"/> No	
Dry pipe valve	no full flow trip test done after 3 years (12.4.4.2.2.2)	Yellow	<input type="checkbox"/> Yes <input type="checkbox"/> No	
Quick opening device	Quick opening device did not pass test (12.4.4.2.4.)	Orange	<input type="checkbox"/> Yes <input type="checkbox"/> No	
Dry pipe valve	Low air pressure switch did not send signal or no	Yellow	<input type="checkbox"/> Yes <input type="checkbox"/> No	

	alarm (12.4.4.2.6)			
Dry pipe valve	Low temperature switch did not send signal or no alarm (12.4.4.2.7)	Yellow	<input type="checkbox"/> Yes <input type="checkbox"/> No	
Dry pipe valve	Automatic air maintenance device did not pass test (12.4.4.2.8)	Orange	<input type="checkbox"/> Yes <input type="checkbox"/> No	
Sprinkler pressure reducing control valves	No full flow test done after 5 years or test results not comparable to previous results (12.5.1.2)	Yellow	<input type="checkbox"/> Yes <input type="checkbox"/> No	
Hose connection pressure reducing valves	No full flow test done after 5 years or test results not comparable to previous results (12.5.4.2)	Yellow	<input type="checkbox"/> Yes <input type="checkbox"/> No	
Hose rack assembly pressure reducing valve	No full flow test done after 5 years or test results not comparable to previous results (12.5.4.2)	Yellow	<input type="checkbox"/> Yes <input type="checkbox"/> No	
Hose valves(Class I & Class III Standpipe system)	Annual test revealed valve leaking or difficult to operate (12.5.5.2.1.1)	Orange	<input type="checkbox"/> Yes <input type="checkbox"/> No	
Hose valves(Class II Standpipe system)	Test revealed valve leaking or difficult to operate (12.5.5.2.2, 12.5.5.2.2.1)	Orange	<input type="checkbox"/> Yes <input type="checkbox"/> No	
Hose valves(Class II Standpipe system)	No test after 3 years (12.5.5.2.2, 12.5.5.2.2.1)	Yellow	<input type="checkbox"/> Yes <input type="checkbox"/> No	
Backflow prevention assemblies	Did not pass forward flow test (12.6.2.1)	Red	<input type="checkbox"/> Yes <input type="checkbox"/> No	
Backflow prevention assemblies	No forward flow test done after one year (12.6.2.1)	Yellow	<input type="checkbox"/> Yes <input type="checkbox"/> No	

14. LOCAL LAW 58 of 2009

Fire Suppression Piping Components to be identified as required by Local 58/2009

NOTE: Only existing visible piping shall be identified as required. When ceilings are removed during renovations, any existing visible system piping shall be identified and painted.

Standpipe and Sprinkler Feed Mains - The portion of the standpipe or sprinkler system piping that supplies water to one or more standpipe or sprinkler risers.

Standpipe and Sprinkler Cross Connections - The portion of the standpipe or sprinkler system that interconnects the feed mains and risers to the fire department connections.

Standpipe and Sprinkler Risers - The vertical portion of the system piping that delivers the water supply for hose connections, and sprinklers on stand-alone as well as combined systems, vertically from floor to floor.

Fire Department Connections - The portion of the standpipe or sprinkler system that is connected to the fire department pumper connection and supplies the standpipe and sprinkler feed mains, cross connections, and risers.

All handles of Indicating Valves - These handles control controlling the water supplies to the standpipe and sprinkler systems.

Street water supply - The portion of system piping connected to the discharge of the water meter to the main sprinkler control valves.

All pipe material identification information, if present, shall not be painted.

Fire Suppression Piping Components not required to be identified as required by Local 58/2009.

Fire Department Hose valve bodies and handles, indicating control valve bodies, check valves, jockey pump control valves, trim, test, and drain valve handles.

Standpipe Branch Piping - The portion of the piping system connecting one or more hose valve stations.

Sprinkler Cross Mains - The portion of the piping system connecting supplying the branch lines either directly or through risers.

Sprinkler Feed Mains - The portion of the piping system downstream of a sectional or floor control valve supplying cross mains.

Sprinkler Branch Piping - The portion of the piping system to which the sprinkler heads or nozzles are directly connected to.

For more info go to the attached URL (NYC Building website Local law 58/2009)

<http://www.nyc.gov/html/dob/downloads/pdf/l158of2009.pdf>



STANDPIPES + SPRINKLERS

New Safety Regulations

New standpipe and sprinkler piping laws go into effect in 2010. Building owners and contractors must be sure their properties and projects comply with these new local laws.

The Buildings Department participated in the multi-agency advisory group that proposed these new safety standards. Mayor Michael R. Bloomberg appointed Deputy Mayor Edward Skyler to lead the Construction, Demolition and Abatement Working Group, which generated 33 safety recommendations – including the four local laws described here.

To learn more, read *Strengthening the Safety, Oversight and Coordination of Construction, Demolition and Abatement Operations*, available at nyc.gov/buildings.

CUTTING AND CAPPING

Local Law 60/09, effective 3/2/2010.

Permits are required to cut and cap standpipes or sprinklers.

- Authorized Licensees: Only licensed master plumbers or licensed master fire suppression piping contractors may cut and cap standpipes or sprinklers during demolition.
- Local Law Incorporates TPN 3/07: For demolitions and gut rehabilitations, a registered design professional must have a variance to remove damaged or inoperable sprinklers. This filing must include a damage report and explanation why the system can't be restored. (The design professional must first file the variance with the Fire Department and have FDNY approval before filing it with the Buildings Department.)

COLOR CODING

Local Law 58/09, effective 3/2/2010.

Existing buildings must comply by 6/2/2010.

All exposed standpipes and sprinkler piping must be painted red. The law outlines specific exceptions, such as branch piping.

All buildings – no matter the size or occupancy – must comply with these new requirements.

Dedicated standpipe valve handles must be painted **red**.



Combination standpipe valve handles must be painted **yellow**.



Dedicated sprinkler valve handles must be painted **green**.



COLOR CODING CERTIFICATION

Buildings Under Construction

The special inspector will confirm compliance before the walls are enclosed.

Existing Buildings

Owners of buildings with exposed sprinkler piping and standpipes must comply and hire one of four types of contractors to certify the color coding:

- Licensed master plumbers;
- Licensed master fire suppression piping contractors;
- Registered design professionals; or
- People with the appropriate Fire Department Certificate of Fitness.

PROOF OF COLOR CODING CERTIFICATION

The color coding certification must be kept on the premises at all times for Buildings and Fire Department inspection. Visit nyc.gov/buildings for the certification form, available online in March 2010.

(over)

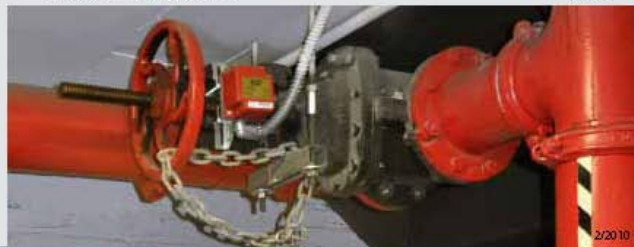

Robert D. LiMandri, Commissioner

Michael R. Bloomberg, Mayor

15. OBSTRUCTION INVESTIGATION

Obstruction Investigation - The presence of obstructions in sprinkler systems shall be checked every five years by opening a flushing connection at the end of one main per system. One sprinkler head per system toward the end of one branch line shall also be removed. This is done for investigating for the presence of foreign organic or inorganic material.

Sources of obstructions to piping include but are not limited to pipe scale, careless installation or repair, raw water sources, biological growth, sprinkler calcium carbonate deposits and Microbiologically Influenced Corrosion (MIC).

Inorganic material would include but not be limited to silt, sand, rocks, gravel, and construction debris. Organic material includes wood, microbes, and zebra mussels. While zebra mussels not reported in the NYC area, the Hudson River contains this predator, and it is possible contamination may occur in NYC's upstate water supplies. http://www.nyc.gov/html/dep/html/press_releases/97-45pr.shtml



Piping Infested with Zebra Mussels

When tubercules and slime are found during the investigation, they shall be tested for MIC.

An obstruction investigation shall also be performed whenever the following conditions exist such as pinhole leaks, a record of broken public water mains in the vicinity, foreign material in water discharged during drain tests or plugging of inspector's test valve connection. A complete list of system conditions requiring obstruction investigation are listed in Chapter 14 and Annex D of NFPA #25 2011 edition.

16. DIFFERENT TYPES OF SPRINKLER HEADS & COMPONENTS

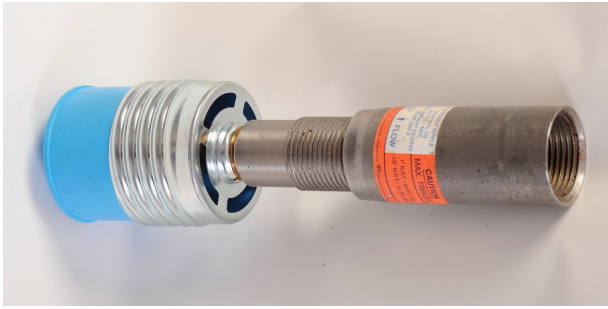

Adjustable Concealed Sprinkler Heads



Concealed (Recessed) Sprinkler Head



Recalled Omega Sprinkler Head



165° F Upright Sprinkler Head

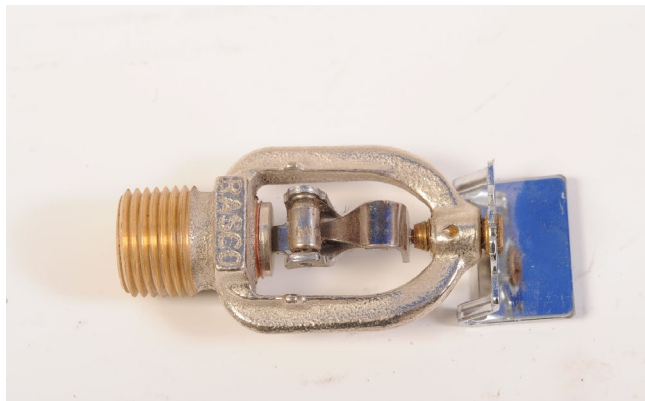

Chrome Sidewall Sprinkler Head



Dry Pendent Sprinkler Head



165°F Upright Sprinkler head



Conventional Sprinkler Heads



ESFR (Early Suppression Fast Response) (286°F) Sprinkler Heads fusible frame



Horizontal Sidewall Sprinkler Head

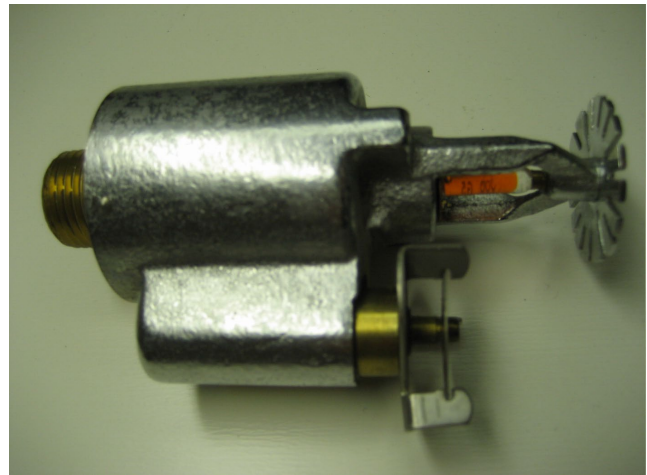

Recalled ON-OFF Sprinkler head

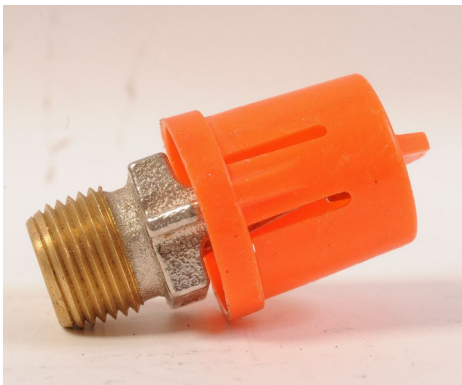

Sprinkler Head with a factory protective cap



Horizontal sidewall Sprinkler Head



200°F In-Rack Sprinkler Head



Large Drop 286°F Sprinkler Head



Factory applied finish sprinkler head



Loaded Sprinkler in Head Cage Head



165°F Brass side wall Sprinkler head



165°F Chrome Horizontal side wall sprinkler head



200°F Chrome Upright sprinkler



Recessed Pendent Sprinkler



Flush Pendent Sprinkler

Recalled Sprinkler Heads



Cycling and On/Off sprinkler head examples

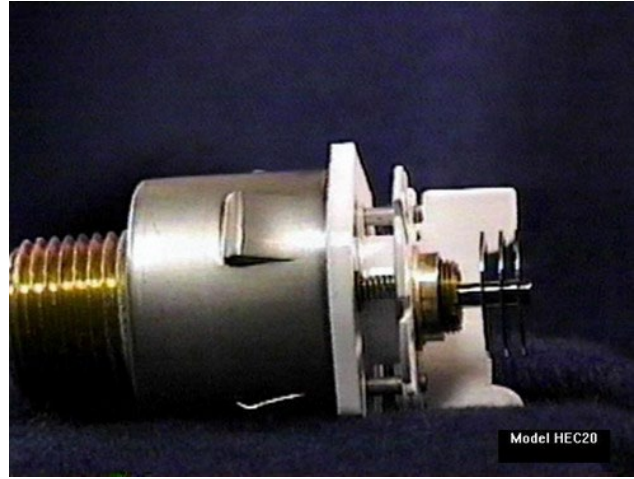

Omega hec20



Recalled On/Off Pendent Sprinkler



Recalled Pendent Omega Sprinkler

Sprinkler Wrenches



Concealed Sprinkler Head Wrenches



Sprinkler Head Wrenches



Concealed Sprinkler Head Wrench



Concealed Sprinkler Head Wrenches



**Concealed/recessed
Sprinkler Head Wrench**

Typical Pipe Hangers



Split Ring, Band Hanger, Clevis hanger

Impaired or Defective Components



Defective Water Pressure Gauge



Defective Water Pressure Gauge Exposed to Freezing Temps



Sprinkler System Improper Hanger



Rotted Piping

Valves and Valve Connections



OS & Y valve Not Sealed, Locked, Electronically Monitored, Labeled and Valve Handle Not Painted



Corroded Curb Valve in Sidewalk Vault



Fire Department Test Manifold



Sprinkler & Standpipe Fire Department Connections

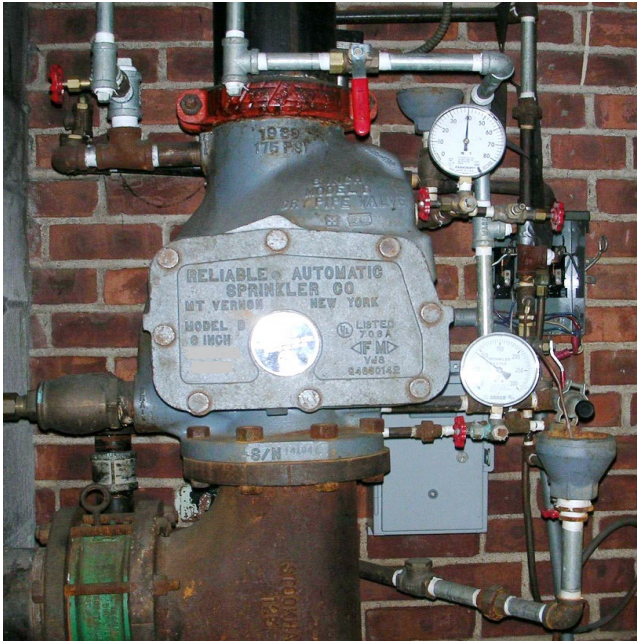

Dry Pipe Valve Assembly

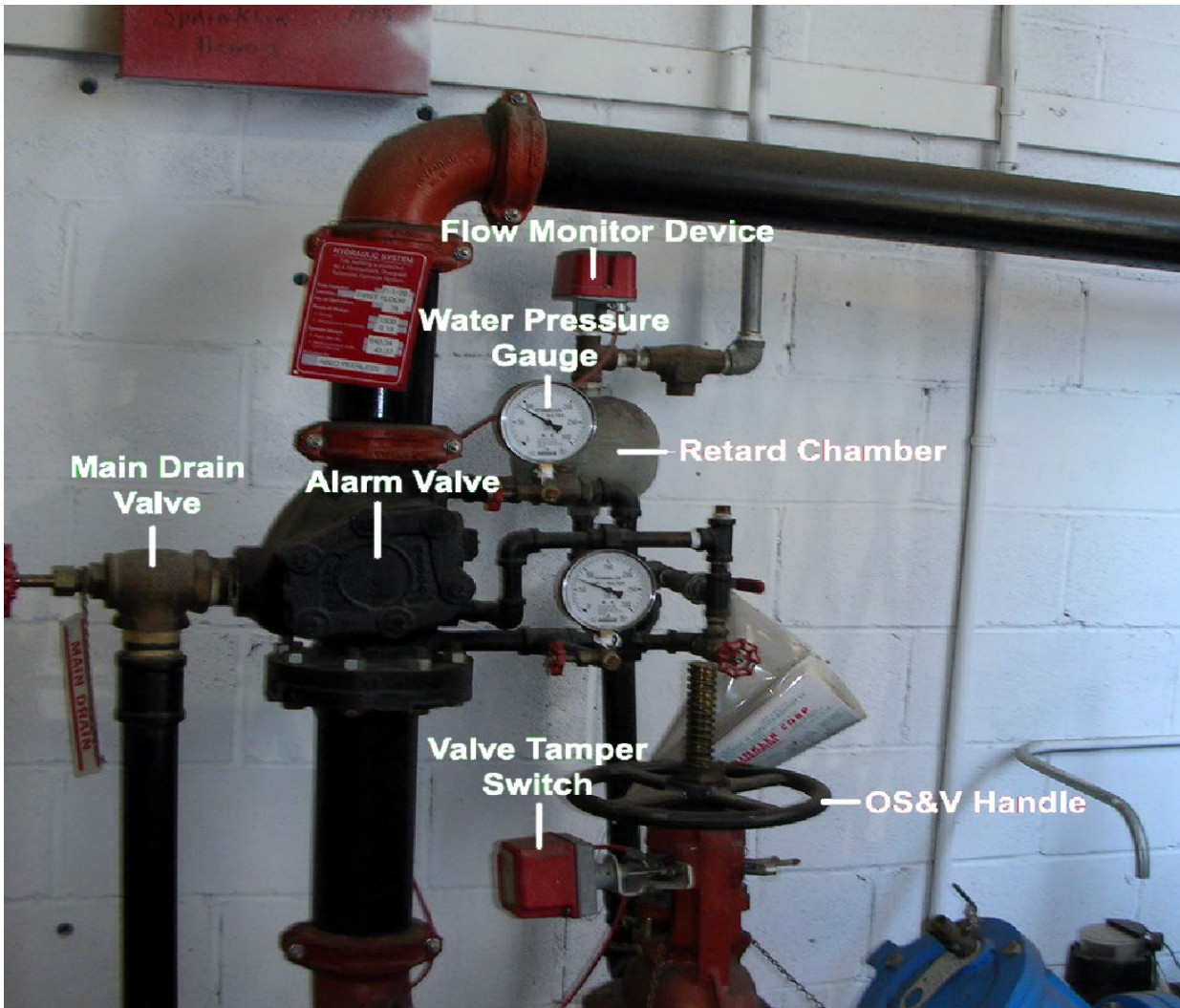

Correct Installation of Hydraulically Calculated Wet System with Alarm Valve

17. FOAM-WATER FIRE SUPPRESSION PIPING SYSTEM

17.1 INTRODUCTION

For years, foam has been used as a fire extinguishing medium for flammable and combustible liquids. Unlike other extinguishing agents - water, dry chemical, CO₂, etc., a stable aqueous foam can extinguish a flammable or combustible liquid fire by the combined mechanisms of cooling, separating the flame/ignition source from the product surface, suppressing vapors and smothering. It can also secure for extended periods of time against reflash or re-ignition. Water, if used on a standard hydrocarbon fuel, is heavier than most of those liquids and if applied directly to the fuel surface, will sink to the bottom having little or no effect on extinguishment or vapor suppression. If the liquid fuel heats above 212°F, the water may boil below the fuel surface throwing the fuel out of the contained area and spreading the fire.

17.2 FOAM EXTINGUISHING SYSTEMS

Foam fire extinguishing systems shall be periodically inspected, tested and otherwise maintained in accordance with information described in this study material as well as NFPA 25 (2011), NFPA 11 (2005), as modified by Fire Code Appendix B, and NFPA 16 The Standard for Installation of Foam-Water Sprinkler and Foam-Water Spray Systems (2007), as modified by Fire Code Appendix B, and manufacturers listing.

These systems are used primarily for property protection and may be operated both manually and automatically to protect both Class A and Class B hazards using low expansion foam.

Foam is very effective and is the most common method of fighting fires in fuel oil storage. Foam is created by mixing a 3% foamite concentrate with water and air.

The foam is designed to smother the flame and prevent re-ignition. Fixed foam-generating systems automatically control the water and foam concentrate mixture.

EXAMPLE OF BALANCE PRESSURE PUMP SKID WITH TWO PROPORTIONERS

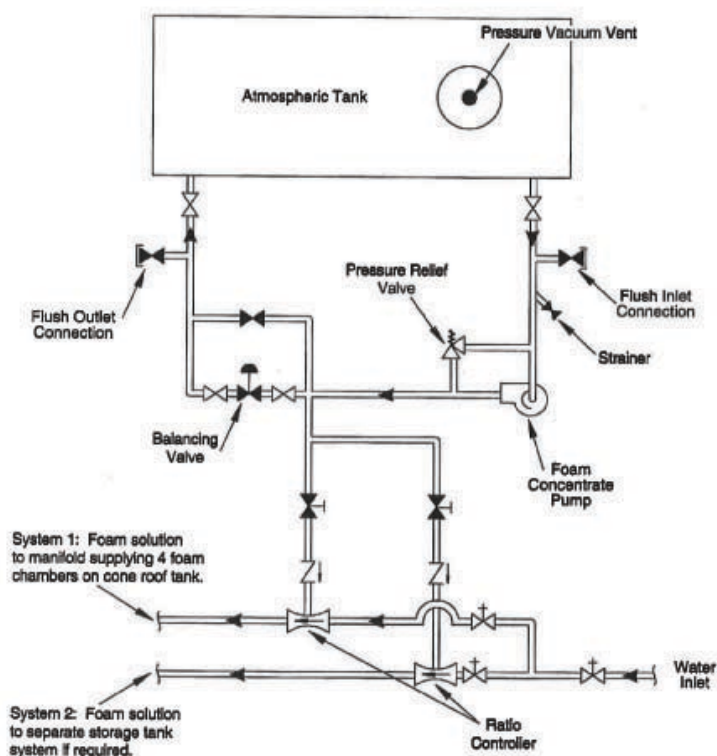

17.3 FOAM TYPES ARE SUBDIVIDED INTO THREE RANGES

- 1) Low-expansion foam uses foam to solution volume ratios up to 20 to 1.
- 2) Medium-expansion foam uses foam to solution volume ratios from 20 to 1 to 200 to 1
- 3) High-expansion foam use foam to solution volume ratios from to 200 to 1 to approximately 1000 to 1.

It is important to note that different foam manufacturers may not produce foam solution that is compatible with each other. Great care must be exercised when testing and maintaining these systems to be certain that all the equipment is listed to be used together.

Foam-Water Sprinkler Systems and Foam Water Spray Systems use low-expansion type foams and are connected to a source of foam concentrate and an automatic water supply. The water supply system is activated by detection devices in the same area the sprinklers or discharge nozzles are located. When the control valve operates the water flows into the system piping and foam concentrate is injected into the water producing a foam solution that discharges for a specified duration through all open sprinklers or nozzles. In order to provide extinguishment of the fire, these systems must be designed using the proper discharge devices, pipe sizes, water pressure and flow rates along with the correct type and volume of foam concentrate along with the appropriate mixing mechanism required to extinguish the fire. The method of fire extinguishment is by covering the fuel cutting off the oxygen supply to the fire along with cooling the fuel due to the water content of the mixture.

Foam Water systems may also be used in fire prevention by covering the surface of a flammable or combustible liquid spills to contain the vapors that are subject to ignition. Foam solutions are not an effective extinguishment agent for fires involving compressed gases, flammable metals or electrical fires due to the water contained in the mixture. Foam solutions do have the potential to pollute water supplies and great care should be taken to contain foam solution run off where applicable. When possible, foam concentrate shall be recycled back into the storage tank during the maintenance procedures.

INSPECTION

The inspection of water based foam fire suppression piping systems may be performed by a valid S-15 COF holder.

TESTING AND MAINTENANCE

The testing and maintenance of water based foam fire suppression piping systems shall only be performed by a licensed MFSPC (master fire suppression piping contractor) with a CLASS A LICENSE and a valid S-15 COF.

INSTALLATION

The installation of the water based foam fire suppression piping systems shall only be performed by a licensed MFSPC (master fire suppression piping contractor) with a CLASS A LICENSE.

17.4 INITIAL INSTALLATION AND PERIODIC PERFORMANCE TESTING

Foam fire extinguishing systems shall be subject to acceptance tests as contained in the installation standards set forth in NYC Fire Code and the NYC Fire Rules. When a discharge test is not required by the installation standard, the Fire Commissioner may require such test when there is evidence that the system will not provide the necessary level of protection. Such tests as required by the Fire Commissioner shall be conducted at the owner's risk by his or her representative before a representative of the NYC Fire Department every 2 years.

17.5 MAINTENANCE

At least **once a month**, an inspection shall be conducted by a S-15 Certificate of Fitness holder to assess whether the system is in good working order. Foam fire extinguishing systems shall be maintained in good working order at all times.

Any foam fire extinguishing system that is not in good working order shall be repaired or replaced as necessary to restore such system to good working order, or, where authorized by the Building Code, removed from the premises.

Only a S-15 Certificate of Fitness holder employed by CLASS A licensed master fire suppression piping contractor (MFSPC) properly trained and having the knowledge of the installation, operation and maintenance of the specific foam fire extinguishing system, shall inspect, test, service and otherwise maintains such system in accordance with the NYC Fire Code and NFPA 25 (2011).

17.6 FOAM-WATER SPRINKLER SYSTEM TYPES

Foam-Water Sprinkler Systems are similar to Fire Sprinkler Systems in their operation.

Pre-primed Foam-Water Systems: operation is the same as a wet sprinkler system with fusible links on the sprinkler heads or discharge nozzles with system piping charged with a foam solution.

Dry Pipe Foam-Water Systems: operation is the same as a dry pipe sprinkler system using sprinkler heads or discharge nozzles with fusible links and system piping under pneumatic pressure. Upon the operation of a fusible link, the pneumatic pressure is released and the dry pipe valve opens permitting the water/foam solution into the system.

Pre-Action Foam-Water Sprinkler Systems: equipped with sprinklers or nozzles with fusible links along with a detection system in the protected area that may be electrically, hydraulically, or pneumatically operated. A manual release is also required for tripping the control valve. System discharge piping may or may not be pneumatically supervised for piping integrity.

Deluge Foam-Water Sprinkler Systems: equipped with open nozzles and are operated by a detection system in the protected area that may be electrically, hydraulically, or pneumatically operated. A manual release is also required for tripping the Deluge valve.

17.7 FOAM CONCENTRATE SOLUTIONS ARE SPECIFICALLY MANUFACTURED TO SUPPRESS DIFFERENT TYPES OF FIRES AND ARE GROUPED AS FOLLOWS:

Class A Foams: operate by lowering the surface tension of water assisting in the wetting and saturation of Class A fuels which include wood and paper. These foam solutions are unable to control the explosive vapors produced by flammable liquids and are not appropriate to protect Class B fires.

Class B Foams: operate by smothering the fire by removing oxygen from the fire triangle. They also form a film over the flammable liquid to contain the flammable vapors. These foams are the most common type used in Foam-Water Sprinkler Systems. Class B Foams are classified as Synthetic or Protein. Protein Foams from non-animal sources are preferred due to their limited biological components that are less harmful to the environment.

Alcohol Resistant Foam Concentrate: used for fires on water soluble materials and hydrocarbon fires and other fuels destructive to AFFF or FFFP foams. These foams will form a blanket over the surface of the alcohol.

Aqueous Film Forming Concentrate (AFFF): a concentrate based on fluorinated surfactants with a foam stabilizer and are diluted with water to a 1%, 3% or 6% solution. These foams have the ability of spreading over the surface of hydrocarbon based liquids.

Film Forming Fluoroprotein Foam Concentrate (FFFP): a concentrate that uses fluorinated surfactants and produce a fluid aqueous film and is used to suppress hydrocarbon fuel vapors.

Fluoroprotein Foam Concentrate: similar to protein-foam concentrate with a synthetic fluorinated surfactant additive.

Medium and High Expansion Foam Concentrate: used in specially designed equipment and have a foam to solution ratio from 20 to 1 up to 1000 to 1.

17.8 FOAM ROOM

Foam room is designed to store equipment used for creating and supplying the foam to the designated areas. In this room the foam concentrate and the water are automatically mixed and distributed through piping system and to the foam heads.

Where a Fire Department connection is provided it must be installed as part of the foam fire extinguishing system. The Fire Department connection may be designed to either supply the water to the foam room or finished foam solution to the storage tank area.

It is critical that the foam room has all the labels properly posted, as per diagram. For example, every valve shall be labeled in the foam room so that in case of an emergency, time is not wasted in determining which foam valve controls the flow to the specific storage tank area.

17.9 FOAM-WATER SPRINKLER AND SPRAY SYSTEM COMPONENTS

Discharge devices for foam water wet pipe, dry pipe, and preaction systems are required to be automatically operated and must be non-air aspirating. Standard spray sprinklers are commonly used in these systems.

Discharge devices for deluge systems are permitted to use air-aspirating nozzles and also standard spray sprinklers. There must be a reserve supply of foam concentrate available to place systems that have discharged back into operation within 24 hours.

Foam-Water Discharge Devices: such as chambers, and foam outlets shall be inspected visually and maintained to ensure that they are in place, and are free from external loading and corrosion. Where caps or plugs are required, the inspection shall confirm they are in place and free to operate as intended.

Foam Concentrate Proportioning: positive pressure or balanced pressure injection are the preferred methods of supplying foam concentrates into the water flowing through the supply piping. Piping schematics illustrating all components and configurations may be found in NFPA 11 2005 edition and are broken down as follows:

- 1) Balance pressure proportioning systems use a foam concentrate pump that discharges through a metering orifice that has the foam and water pressure maintained using a pressure balancing valve.
- 2) Balanced pressure proportioning system utilizing a pressure proportioning tank with a diaphragm or bladder that separates the foam from the water. This arrangement discharges the foam concentrate through a metering orifice into a proportioning controller.
- 3) In line balanced pressure proportioning system using a foam concentrate pump or bladder tank. A pressure regulating valve is placed in the pump return line and maintains constant pressure at all design flow rates. It is required that the constant pressure be greater than the maximum water pressure.
- 4) Foam concentrate pump discharging through a metering orifice into the piping system riser with foam pressure at the upstream side of the orifice greater than the water pressure in the system riser greater by a specified design value.

Other positive pressure injection systems that are listed may be also used including inline inductors, around the pump proportioning, and balanced pressure injection systems utilizing a foam concentrate pump with a variable speed motor that matches pump output to water flow rates so as to maintain the correct percentage of required foam concentrate.

Foam Concentrate Pumps: These devices shall be maintained and tested using the same frequencies a fire pumps and shall be equipped with pressure relief valves and connections to facilitate draining and flushing. These pumps shall start automatically when the system activates.

Foam Concentrate Tanks: These tanks must be located in areas not subject to temperatures below the foam manufacturer's requirements and must be permanently mounted.

Atmospheric Type Storage Tanks: These tanks must be fitted with manholes located to allow for inspection of interior tank surfaces, connections for pump suction, relief, testing lines, liquid level indicators along with filling and drainage connections.

17.10 FOAM DELIVERY SYSTEM TYPES

Methods of delivering foam concentrate to the system include:

- **Standard Proportioner** - are devices that are specifically and uniquely designed for each particular system. The way the proportioners work is by introducing the concentrate into the flow of water. Works without any extra pressure on the foam concentrate.
- **Bladder Tank Proportioner** - is similar to a standard pressure proportioner, EXCEPT the foam concentrate is contained inside a diaphragm bag that is within a pressure vessel (uses extra pressure). Operation is the same as a standard pressure proportioner, EXCEPT this system can be used with all foam concentrates, regardless of specific gravity. (MOST COMMON)

17.11 FOAM EXTINGUISHING SYSTEMS SHALL BE COLOR-CODED AS FOLLOWS

- **Piping, valve bodies and handles:** RED with contrasting bright ORANGE bands.
- **Fire Department water connections:** RED. A durable sign that reads “WATER FOR FOAM SYSTEM”, shall be conspicuously posted immediately adjacent to such connections.
- **Fire Department foam connection:** RED with contrasting bright ORANGE band or caps. A durable sign that reads “CHEMICAL FOAM DIRECT TO TANKS” or “3% MECHANICAL FOAM SOLUTION DIRECT TO TANKS”, shall be conspicuously posted immediately adjacent to such connections.

18. FORMER S-12 and NEW S-12: LIST OF MAJOR CHANGES

THE FOLLOWING INFORMATION IS TAKEN OUT OF THE NEW S-12/S-15 CERTIFICATE OF FITNESS STUDY MATERIAL. BELOW IS A LIST OF MAJOR CHANGES.

Responsibilities of a fire watch personnel when a Fire Protection system is out of service - (FC 901.7.2.1)

Planned removal from service – Impairment Coordinator responsibilities – Fire Watch (901.7.3)

Records - All system inspections, tests, servicing and other maintenance shall be maintained on the premises or other approved location for a minimum of 3 years - (FC 901.6.2)

In addition to those records required by NFPA 25 as mentioned above, an approved card bearing the dates of each inspection, certificate of fitness number and signature of the certificate of fitness holder shall be posted on the premises near the main water supply control valve. (This approved card shall not replace or supersede the detailed record of inspection) – 901.6.2.1

DEFINITIONS: (3.3.4.1 NFPA)

CRITICAL DEFICIENCY – A deficiency that, if not corrected, can have an effect on the performance of the fire protection system.

NON CRITICAL DEFICIENCY – A deficiency that does not have an effect on the performance of the fire protection system, but correction is needed for the proper inspection, testing, and maintenance of the system(s).

FIRE PUMP, AUTOMATIC STANDPIPE - A fire pump located at or below street level that supplies the lower 300 feet (91.4m±) of a standpipe system or a combined standpipe and sprinkler system.

FIRE PUMP, FOAM - A fire pump used to boost water supply pressures in a fire protection system where such system uses firefighting foam as an additive.

FIRE PUMP, LIMITED SERVICE - A fire pump with a motor rating not exceeding 30 hp and utilizing a limited service fire pump controller.

FIRE PUMP, SPECIAL SERVICE - A fire pump that is located above street level and that receives its water supply from a gravity tank or suction tank.

FIRE PUMP, SPRINKLER BOOSTER PUMP - A fire pump that supplies sprinkler systems only.

FIRE PUMP, WATER MIST SYSTEM - A fire pump used to boost water supply pressures in a fire protection system where such system utilizes water misting technology.

AUTOMATIC PRESSURE MAINTENANCE DEVICE - Maintains pneumatic pressure on the piping system set to specific limits by controlling a plant air system, a single air compressor, or a nitrogen supply.

SYSTEM TYPES: AUTOMATIC WET SPRINKLER SYSTEM: ANTIFREEZE SPRINKLER SYSTEM.

The freezing point of solutions in antifreeze shall be tested annually by measuring the specific gravity with a hydrometer or refractometer and adjusting the solutions if necessary. Annual testing must be performed in accordance with NFPA 25 2011.

CONTROL VALVES: System Control Valve Signage (FC 903.5.4)

A sign identifying the location of the sidewalk box housing the sprinkler system control valve shall be conspicuously posted on the exterior wall of the building directly opposite the sidewalk box. Such sign shall have red letters 1 inch in height on a white background and read: "Sprinkler System Shutoff Valve (*indicate distance*) feet opposite this sign" or other approved design. This was in 1968 Building Code but was omitted in the 2008 Codes.

FIRE DEPARTMENT CONNECTIONS (FC 312.3.2)

Fire Department connections must always be accessible. A working space of not less than 36 inches in width, 36 inches in depth and 78 inches in height shall be provided and maintained in front of and around wall-mounted and free-standing fire department connections, except as otherwise required or approved.

Sprinkler System Control Valve Signage (FC 903.5.4)

A sign identifying the location of the sidewalk box housing the sprinkler system control valve shall be conspicuously posted on the exterior wall of the building directly opposite the sidewalk box. Such sign shall have red letters 1 inch in height on a white background and read: "Sprinkler System Shutoff Valve (*indicate distance*) feet opposite this sign" or other approved design.

Special service pumps – Special service pumps are sometimes used in sprinkler and standpipe systems. These pumps are small pumps with limited power taking suction from gravity tanks. These pumps are used when the water pressure available does not quite meet the needs of the sprinkler/standpipe system. This small pump increases the water pressure and volume in the sprinkler/standpipe system until it reaches acceptable levels. The special service pump should not be confused with the pressure maintenance pumps (jockey pumps). Special service pumps shall be maintained according to NFPA 25 standard for fire pumps.

19. LITHIUM-ION BATTERY SAFETY

Lithium-ion safety

Lithium-ion batteries are rechargeable batteries found in electric bikes, scooters, cars, laptops, tablets, phones, and many other common household devices.

Lithium-ion battery fires have caused deaths, serious injuries, and devastating damage to property around the city. It's important to follow rules for safe storage, charging, and disposal for these types of batteries.

If you own a lithium-ion powered device or plan to buy one, the FDNY has important safety tips that you should follow. These tips apply to all devices powered by lithium-ion batteries, including phones, tablets, laptops, e-cigarettes, toys, high-tech luggage, and even robotic vacuum cleaners.

Immediately stop using or charging battery and call 911 if you notice:

- Fire or Smoke
- Overheating
- Change in color or shape
- Odd noises
- Leaking
- Strange smell

ALWAYS:

- purchase and use devices certified by a Nationally Recognized Testing Laboratory (NRTL). 
- follow the manufacturer's instructions for:
 - charging and storage.
 - correct battery, cord, and power adapter
- **keep exit path clear at all times.**
- plug directly into a wall electrical outlet for charging.
- keep batteries and devices at room temperature.
- store and/or charge batteries away from anything flammable.
- keep away from heat sources.
- bring batteries to a **NYC Battery Recycling Center**. Visit nyc.gov/batteries for more information.

NEVER:

- use aftermarket batteries or chargers.
- use damaged or altered batteries
- plug into a power strip or overload an outlet.
- overcharge or leave battery charging overnight.
- charge a battery or device under your pillow, on your bed, or near a couch.
- leave e-bikes or e-scooters unattended while charging.
- block your primary way in or out of a room/space with e-bikes, e-scooters, wheelchairs, etc.
- place batteries in Trash or Recycling bin. **It is ILLEGAL.** Visit nyc.gov/batteries for disposal locations and information.

**In the event of a Fire,
Leave and CLOSE the door.
Call 911 once you are
in a safe location.**



Charging Lithium Ion

Lithium-ion batteries do not have to be fully charged; partial charge is the most suitable.

When **charging more than five (5)** personal mobility devices or their removable batteries, it must be in a **dedicated room with ventilation** and a self-closing door.

For a total battery capacity of 20 kilowatt-hours (kWh), a 2-foot separation between charging batteries is required. For a total battery capacity up to 50 kWh, a 3-foot separation is needed.

Chargers must only be used with a compatible battery pack. The original equipment manufacturer (OEM) charger interplays with the battery pack using the battery management system (BMS). The wrong battery/charger combination may not work safely. For example, the 100% cutoff to prevent overcharging, which damages batteries, may not work which can easily create hazardous conditions such as fires, explosions and/or injuries.

Always check with the manufacturer or retailer of the personal mobility device, an authorized repair shop or a testing laboratory such as Underwrites Laboratories (UL) to see if replacement is recommended or listed and safe for use with that device. Using unauthorized parts, including batteries and/or chargers, may cause damage, fire and possibly void your warranty.

Extinguishing Lithium-ion

Water may not prevent a battery from burning and spreading. Battery cells are known to explode and quickly spread to another battery. It can spread to another devices.



Fire Extinguishers
do not work
 on lithium-ion batteries fires.

Unexpected Re-ignition.

Reignition is common. Lithium-Ion Batteries are known to unexpectedly re-ignite (without warning) minutes, hours and even days after all visible fire has been put out.

Lithium-ion batteries can enter an uncontrollable, self-heating state. This can result in the release of gas, cause fire and possible explosion.

These batteries may continue to generate heat even when there is no visible sign of fire. Once heat reaches a certain level fire may reignite on the battery and surrounding area.

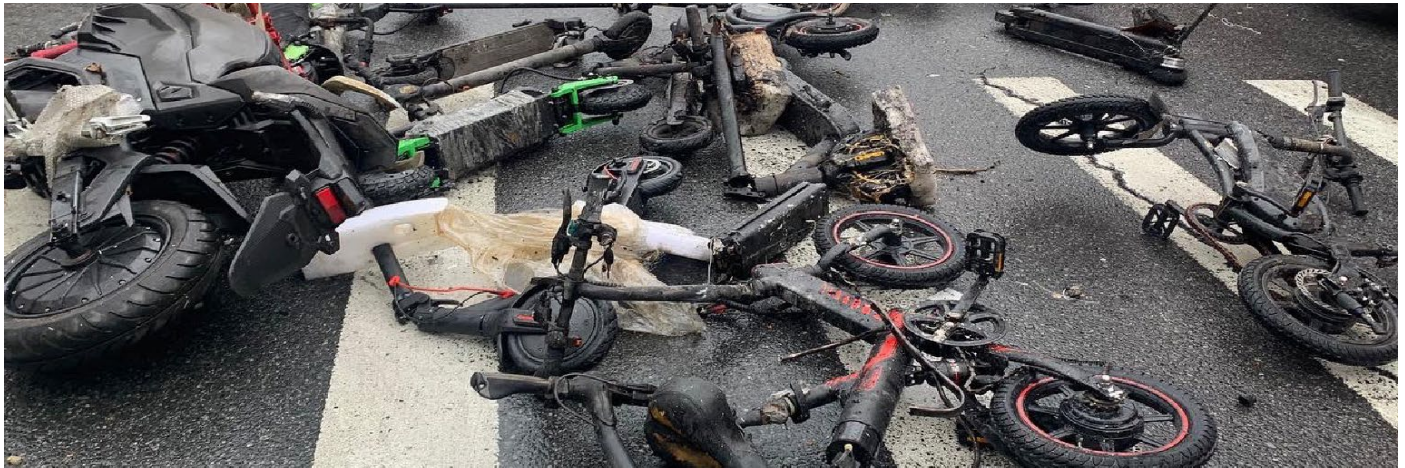

20. REFERENCE MATERIAL

(Text in **RED** font is **NEW**)

C of F	S-12/S-15 Certificate of Fitness				
Engineer	Refrigeration Operating Engineer (Q-01 or Q-99), NYC High Pressure Operating Engineer, NYS High Pressure Operating Engineer with S-12/S-15 C of F <i>*(For employees of a single or multiple properties under common ownership employed by the same building owner/management company)</i>				
MFSPC	Master Fire Suppression Piping Contractor License (A or B) with S-12/S-15 C of F.				
MP	Master Plumber License (MP) with S-12/S-15 C of F.				
¹ Limited to residential occupancies 30 sprinkler heads or less without booster pump. ² S-95 Supervision for Fire alarm Systems & other related systems. ³ Follow testing requirement. ⁴ Record must be maintained to be checked annually. ⁵ Must be performed once annually by licensed contractor. ⁶ The building owner shall ensure all water filled piping shall be maintained at a minimum of 40° degrees Fahrenheit. ** Water Spray Fixed Systems ONLY.					
Components					
Components		May be performed by			
		C of F	Engineer	MFSPC	MP
I. INSPECTION					
A. Sprinkler Systems		Frequency			
WEEKLY (52)					
Gauge (dry, pre-action, deluge sys) non supervised		Yes	Yes	Yes	Yes
MONTHLY (12)					
Gauge (dry, pre-action, deluge sys) supervised		Yes	Yes	Yes	Yes
Gauge - wet pipe system		Yes	Yes	Yes	Yes
QUARTERLY (4)					
Waterflow alarm devices		Yes	Yes	Yes	Yes
Supervisory signal devices		Yes	Yes	Yes	Yes
Valve supervisory alarm device		Yes	Yes	Yes	Yes
Hydraulic name plate		Yes	Yes	Yes	Yes
Drainage**		Yes	Yes	Yes	Yes
Fittings**		Yes	Yes	Yes	Yes
Fittings (rubber-gasketed)**		Yes	Yes	Yes	Yes
ANNUALLY (1)					
Buildings - (prior to freezing weather) exterior of building should be examined to prevent freeze-ups fire suppression piping.		Yes⁶	Yes⁶	Yes⁶	Yes⁶
Hanger/seismic bracing		Yes	Yes	Yes	Yes
Pipe and fittings		Yes	Yes	Yes	Yes
Spare sprinkler heads/wrenches		Yes	Yes	Yes	Yes
Sprinkler heads		Yes	Yes	Yes	Yes
Heat tape		Yes	Yes	Yes	Yes
Information sign		Yes	Yes	Yes	Yes
Nozzles** (annually and after each system activation)		Yes	Yes	Yes	Yes
B. Fire, Booster and Special Service Pumps					
WEEKLY (52)					
Pump house, heating ventilating louvers		Yes	Yes	Yes	Yes
Pump suction and discharge and by-pass valves are fully open		Yes	Yes	Yes	Yes
Fire pump system		Yes	Yes	Yes	Yes
		Tank level			
		Tank float switch			

Diesel Engine Pump System	Fuel	Solenoids valve operation	Yes	Yes	Yes	Yes
		Water in the fuel sys				
		Flexible hoses and connectors				
		Piping				
		Tank vents & overflow piping unobstructed				
	Lubrication system	Oil level				
		Lube oil heater				
		Crankcase breather				
	Cooling system	Level				
		Adequate cooling water to heat exchanger				
		Water pumps				
		Cond. of flexible hoses & connection				
		Jacket water heater				
	Exhaust system	Leakage				
Drain condensate trap						
Hangers & supports						
Flexible exhaust section						
Battery system	Electrolyte level					
	Voltage and current readings within an acceptable range					
Electric System	General inspection					
MONTHLY (12)						
Diesel Engine System	Electric System	Circuit breakers or fuses	Yes	Yes	Yes	Yes
	Battery System	Equalize charge	Yes	Yes	Yes	Yes
		Corrosion on pump casing, clean and dry housing	Yes	Yes	Yes	Yes
QUARTERLY (4)						
Diesel Engine System	Exhaust system	Insulation & fire hazards	Yes	Yes	Yes	Yes
	Battery System	Terminals clean and tight				
	Electrical Motor Pump System	Wire chafing where subject to movement				
SEMIANNUALLY (2)						
Diesel Engine System	Electrical system	Operation of safeties and alarms	Yes	Yes	Yes	Yes
ANNUALLY (1)						
Fire pump system	Check accuracy of pressure gauges and sensors		Yes	Yes	Yes	Yes
	Check pump shaft endplay, coupling alignment					
	Wet pit suction screens					
Diesel Engine System	Cooling system	Inspect duct work, clean louvers (combustion air)	Yes	Yes	Yes	Yes
Electrical system ²	Inspect emergency manual starting means (without power)		Yes	Yes	Yes	Yes
	Check and tighten electrical connections as necessary					
	Check lubricate mechanical moving parts (excluding starters & relays)					
	Check and calibrate pressure switch settings					
C. Water Storage Tank						
DAILY (365)						
Heating System – without low temperature alarms (cold weather)			Yes	Yes	Yes	Yes
WEEKLY (52)						
Temperature alarms not connected to constantly connected location			Yes	Yes	Yes	Yes
Water temperature - with low temperature alarms NOT connected to a			Yes	Yes	Yes	Yes

constantly attended location (heating season)							
Heating system and components – with low temperature alarms (cold weather)				Yes	Yes	Yes	Yes
MONTHLY (12)							
Condition of water in tank – without water level alarms (cold weather)				Yes	Yes	Yes	Yes
Water temperature - with low temperature alarms connected to a constantly attended location (heating season)				Yes	Yes	Yes	Yes
Water - level (without water level alarms)				Yes	Yes	Yes	Yes
Air pressure - (without supervised air pressure source)				Yes	Yes	Yes	Yes
Temperature alarms connected to constantly attended location				Yes	Yes	Yes	Yes
QUARTERLY (4)							
Condition of water in tank - with water level temperature alarms (cold weather below 40°F)				Yes	Yes	Yes	Yes
Water – level (with supervised water level alarms)				Yes	Yes	Yes	Yes
Air pressure – (with supervised air pressure source)				Yes	Yes	Yes	Yes
Tank – exterior				Yes	Yes	Yes	Yes
Support structure				Yes	Yes	Yes	Yes
Catwalks and ladders				Yes	Yes	Yes	Yes
Surrounding area				Yes	Yes	Yes	Yes
ANNUALLY (1)							
Exterior (paint, coat or insulated surfaces)				Yes	Yes	Yes	Yes
Hoops and grillage of wooden tanks (AKA Dunnage)				Yes	Yes	Yes	Yes
Expansion Joints				Yes	Yes	Yes	Yes
3 YEARS							
Interior – (steel tanks without corrosion protection)				Yes	Yes	Yes	Yes
Pressure tanks				Yes	Yes	Yes	Yes
5 YEARS							
Interior - all other types of tanks				Yes	Yes	Yes	Yes
D. Valve and Valve Component							
DAILY (365)							
Pre-action valve and deluge valves - valve enclosure (during cold weather)				Yes	Yes	Yes	Yes
Dry pipe valves and quick opening devices – valve enclosure (during cold weather)				Yes	Yes	Yes	Yes
WEEKLY (52)							
Control Valves		Sealed		Yes	Yes	Yes	Yes
Pre-action valve and deluge valves - valve enclosure equipped with low temperature alarms (during cold weather)				Yes	Yes	Yes	Yes
Dry pipe valves and quick opening devices – valve enclosure equipped with low temperature alarms (during cold weather)				Yes	Yes	Yes	Yes
Gauges on systems (without low air or nitrogen pressure alarms)				Yes	Yes	Yes	Yes
Backflow Prevention assemblies (sealed valves)		Reduced pressure Reduced pressure detectors		Yes	Yes	Yes	Yes
Reduced pressure assembly (sealed valves)		(RPA or RPZ)		Yes	Yes	Yes	Yes
MONTHLY (12)							
Control Valves		Locked Tamper switches		Yes	Yes	Yes	Yes
Alarm valves				Yes	Yes	Yes	Yes
Pressure reducing & Relief valves		Fire Pumps Casing relief valves Pressure relief valves		Yes	Yes	Yes	Yes
Pre-action and deluge valves – Exterior				Yes	Yes	Yes	Yes
Dry pipe valves and quick opening devices – Exterior				Yes	Yes	Yes	Yes
Foam-water sprinkler system proportioning system(s)				No	No	Yes	No
Gauges on systems (other than with low air or nitrogen pressure alarms)				Yes	Yes	Yes	Yes
Backflow Prevention assemblies (secured with locks or electrically supervised)		reduced pressure reduced pressure detectors		Yes	Yes	Yes	Yes
QUARTERLY (4)							

Pressure reducing & Relief valves	Sprinkler systems	Yes	Yes	Yes	Yes
Fire Department Connections		Yes	Yes	Yes	Yes
<u>ANNUALLY (1)</u>					
Pre-action and deluge valves – interior (when trip test is conducted- if no external reset)		No	No	Yes	No
Dry pipe valves and quick opening devices - interior (when trip test is conducted)		No	No	Yes	No
Check valves(Pre-action/deluge valves, dry pipe valves/quick-opening devices)		No	No	Yes	No
Pressure reducing & Relief valves	Hose Connections	Yes	Yes	Yes	Yes
	Hose Racks	Yes	Yes	Yes	Yes
<u>5 YEARS</u>					
Alarm valves	Interior	No	No	Yes	No
	Strainers, filters, orifices			Yes	No
Check Valves - Interior		No	No	Yes	No
Pre-action and deluge valves	Strainers, filters, orifices	No	No	Yes	No
Pre-action and deluge valves – interior (with external reset)		No	No	Yes	No
Dry pipe valves and quick opening devices	Strainers, filters, orifices	No	No	Yes	No

C of F	S-12/S-15 Certificate of Fitness				
Engineer	Refrigeration Operating Engineer (Q-01 or Q-99), NYC High Pressure Operating Engineer, NYS High Pressure Operating Engineer with S-12/S-15 C of F *(For employees of a single or multiple properties under common Ownership employed by the same building owner/management company)				
MFSPC	Master Fire Suppression Piping Contractor License with S-12/S-15 C of F.				
MP	Master Plumber License (MP) with S-12/S-15 C of F.				
¹ Limited to residential occupancies 30 sprinkler heads or less without booster pump. ² S-95 Supervision for Fire alarm Systems & other related systems. ³ Follow testing requirement. ⁴ Record must be maintained to be checked annually. ⁵ Must be performed once annually by licensed contractor. * Foam-Water Sprinkler Systems ONLY. ** Water Spray Fixed Systems ONLY.					
Components		May be performed by			
		C of F	Engineer	MFSPC * license A only	MP¹
II. TEST					
A. Sprinkler Systems					
QUARTERLY (4)					
Alarm Devices	Water motor gong	No	Yes	Yes	Yes¹
Water Spray system test**		No	No	Yes	Yes
SEMIANNUALLY (2)					
Alarm Devices (Vane type water flow devices)		No	Yes	Yes	Yes¹
Pressure Switch Type		No	Yes	Yes	Yes¹
ANNUALLY (1)					
Antifreeze solution		No	No	Yes	Yes¹
Flushing**		No	No	Yes	Yes
Complete foam-water system(s)*		No	No	Yes	Yes
Foam-water solution*		No	No	Yes	Yes
5 YEARS					
Gauges - Remove & send for calibration test or replace as required		No	Yes⁴	Yes	Yes¹
Sprinklers - Remove send for extra high temperature test and replace as required		No	No	Yes	Yes¹
10 years & every 10 yrs thereafter					
Sprinklers - Dry type		No	No	Yes	Yes¹
20 years & every 10 yrs thereafter					
Sprinklers – Fast response and residential		No	No	Yes	Yes¹
50 years & every 10 years after					
Sprinklers (Standard Response)		No	No	Yes	Yes¹
B. Fire, Booster and Special Service Pumps					
WEEKLY (52)					
Pump operation - No-flow condition		No	Yes	Yes	Yes¹
Diesel Engine system	Tank float switch	No	Yes	Yes	Yes¹
	Solenoids valve operation				
MONTHLY (1)					
Fire pump – Electric pump (minimum of 10 minutes)		No	Yes	Yes	Yes¹
Electrical system ²	Isolating switch & circuit breaker	No	Yes⁴	Yes	Yes¹
Battery system	Specific gravity or state of charge				
SEMIANNUALLY (2)					
Electrical system ²	Operating manual starting means (electrical)	No	Yes⁴	Yes	Yes¹

Diesel Engine System	Cooling system	Antifreeze protection level	No	Yes⁴	Yes	Yes¹
	Fuel	Tank float switch				
		Solenoids valve operation				
Electrical system	Operation of safeties and alarms					
ANNUALLY (1)						
Pump operation - Flow condition			No	No	Yes	No
Electrical system ²	Trip circuit breaker (if mechanism provided)		No	No	Yes	No
	Operate emergency manual starting means (without power)					
Exhaust system	Excessive back pressure		No	No	Yes	No
Diesel Engine System	Tank vents and overflow piping unobstructed		No	No	Yes	No
C. Water Storage Tank						
MONTHLY (12)						
Temperature alarms (cold weather)			No	Yes⁵	Yes	Yes¹
High temperature limit switches (cold weather)			No	Yes⁵	Yes	Yes¹
SEMIANNUALLY (2)						
Water level alarms			No	Yes⁵	Yes	Yes¹
5 YEARS						
Level indicators			No	No	Yes	Yes¹
Pressure gauges			No	No	Yes	Yes¹
D. Valve and Valve Component						
QUARTERLY (4)						
Main drain (sole water supply is through a backflow preventer and/or pressure reducing valves)			No	Yes⁵	Yes	Yes¹
Water-Flow Alarms (pertaining to dry valves, pre-action, and deluge valves)			No	Yes⁵	Yes	Yes¹
Foam concentrate strainer(s)*			No	No	Yes	Yes
Pre-action and deluge valves	Priming water		No	Yes⁵	Yes	Yes¹
	Low/high air pressure alarm					
Dry pipe valves and Quick Opening devices	Priming water		No	Yes⁵	Yes	Yes¹
	Low/high air pressure alarm					
	Quick-opening devices					
SEMIANNUALLY (2)						
Control Valves Tamper Switch	Supervisory Alarm		No	Yes⁵	Yes	Yes¹
Water flow alarms	Vane-type and pressure Switch-type water-flow devices		No	Yes⁵	Yes	Yes¹
ANNUALLY (1)						
Main drain			No	No	Yes	Yes¹
Preaction and deluge valves	Full flow		No	No	Yes	Yes¹
Dry pipe valves and Quick Opening devices	Trip test		No	No	Yes	Yes¹
Control Valves	Position		No	No	Yes	Yes¹
	Operation					
Pressure reducing and Relief valves	Circulation relief		No	No	Yes	Yes¹
	Pressure relief valves					
Backflow prevention Assemblies/ <i>Forward flow test</i>			No	No	Yes	Yes¹
Proportioning system(s)-all*			No	No	Yes	Yes
Manual actuation device(s)*			No	No	Yes	Yes
Backflow preventer(s)*			No	No	Yes	Yes

3 YEARS					
Dry pipe valves and quick opening devices	Full flow trip test	No	No	Yes	Yes¹
Pre-action systems	For air leakage	No	No	Yes	Yes
5 YEARS					
Pressure reducing & Relief valves	Sprinkler systems	No	No	Yes	Yes¹
	Hose connections				
	Hose racks				

C of F	S-12/S-15 Certificate of Fitness
Engineer	Refrigeration Operating Engineer (Q-01 or Q-99), NYC High Pressure Operating Engineer, NYS High Pressure Operating Engineer with S-12/S-15 C of F *(For employees of a single or multiple properties under common ownership employed by the same building owner/management company)
MFSPC	Master Fire Suppression Piping Contractor License with S-12/S-15 C of F.
MP	Master Plumber License (MP) with S-12/S-15 C of F.

¹ Limited to residential occupancies 30 sprinkler heads or less without booster pump.

² S-95 Supervision for Fire alarm Systems & other related systems.

³ Follow testing requirement.

⁴ Record must be maintained to be checked annually.

⁵ Must be performed once annually by licensed contractor.

* **Foam-Water Sprinkler Systems ONLY.**

Components	May be performed by			
	C of F	Engineer	MFSPC *License A only	MP ¹

III. MAINTENANCE

A. Sprinkler Systems

ANNUALLY (1)					
Valves (all types)	Control valves	No	No	Yes	Yes ¹
	Preaction/deluge	No	No	Yes	Yes ¹
	Dry pipe valves /quick opening devices			Yes	Yes ¹
Low point drains - (Dry pipe systems)		No	No	Yes	Yes ¹
Foam concentrate samples*		No	No	Yes	Yes ¹

5 YEARS					
Internal Pipe Inspection		No	No	Yes	Yes ¹

B. Fire, Booster and Special Service Pumps

WEEKLY (52)						
Diesel engine system	Fuel	Clean water in the system	No	Yes ⁵	Yes	Yes ¹

MONTHLY (12)						
Diesel engine system	Battery sys	Remove corrosion, case exterior	No	Yes ⁵	Yes	Yes ¹
Foam concentrate pump operation*			No	Yes ⁵	Yes	Yes ¹

QUARTERLY (4)						
Diesel engine system	Fuel	Clean Strainer, filter or dirt leg or combination	No	Yes ⁵	Yes	Yes ¹
	Lubricating sys	Crankcase breather				
	Cooling sys	Water strainer				
	Battery sys	Remove corrosion, case exterior clean & dry				

SEMIANNUALLY (2)						
Diesel engine system	Electrical sys	Boxes, panels and cabinets	No	Yes⁵	Yes	Yes¹
		Circuit breakers or fuses				
ANNUALLY (1)						
Hydraulic			No	No	Yes	Yes¹
Pump system	Lubricate pump bearings		No	No	Yes	Yes¹
	Check accuracy of pressure gauges & sensors					
	Wet pit suction screens (after each pump opera.)					
Mechanical transmission	Lubricate coupling		No	No	Yes	Yes¹
	Lubricate right angle gear drive					
Electrical system	Grease motor bearings		No	No	Yes	Yes¹
Controller, various components			No	No	Yes	Yes¹
Motor			No	No	Yes	Yes¹
Diesel engine system various components	Cooling sys	Inspect duct work clean louvers	No	No	Yes	Yes¹
		Rod out heat exchanger				
		Antifreeze				
	Lubrication sys	Oil change				
		Oil filters				
	Exhaust sys	Excessive back pressure				
EVERY 5 YEARS						
Standard balanced pressure type	Foam concentrate pump(s)* (also refer to manufacturer's instructions and frequency)		No	No	Yes	Yes¹
In-line balanced pressure type	Foam concentrate pump(s)* (also refer to manufacturer's instructions and frequency)		No	No	Yes	Yes¹
C. Water Storage Tank						
SEMIANNUALLY (2)						
Drain silt			No	Yes⁵	Yes	Yes¹
EVERY TWO (2) YEARS						
Embankment-supported coated fabric (ESCF) suction tanks			No	No	Yes	Yes¹
EVERY 10 YEARS						
Bladder tank type	Foam concentrate tank-drain and flush*		No	No	Yes	Yes¹
Corrosion and hydrostatic test*			No	No	Yes	Yes¹
Foam concentrate tank – hydrostatic test*			No	No	Yes	Yes¹
Foam concentrate tank-corrosion and pickup pipes*			No	No	Yes	Yes¹
Line type	Foam concentrate tank-drain and flush*		No	No	Yes	Yes¹
Standard balanced pressure type	Foam concentrate tank*		No	No	Yes	Yes¹
In-line balanced pressure type	Foam concentrate tank*		No	No	Yes	Yes¹
D. Valve and Valve Component						
ANNUALLY (1)						
Control valves			No	No	Yes	Yes¹
Pre-action and Deluge Valves			No	No	Yes	Yes¹
Dry Pipe Valves and Quick-Opening Devices			No	No	Yes	Yes¹
Electrical release component for Pre-action /deluge system (i.e. smoke detectors) ²			No	No	Yes	Yes¹
Foam concentrate samples*			No	No	Yes	Yes¹
5 YEARS						
Ball drip (automatic type) drain valves*			No	No	Yes	Yes¹
Standard balanced pressure type	Balancing valve diaphragm*		No	No	Yes	Yes¹

In-line balanced pressure type	Balancing valve diaphragm*	No	No	Yes	Yes¹
Pressure vacuum vents*		No	No	Yes	Yes¹
<u>10 YEARS</u>					
Sight glass*		No	No	Yes	Yes¹