



## Metadata for Zoning Sketch Maps:

### **Source:**

These PDF maps were created from scanned paper or mylar originals and from original AutoCAD drawings in the Technical Review Division's archive. Maps from 1962-2003 were created from scans of archived paper maps. From 2003 onward these PDF maps were produced directly from original AutoCAD DWG files. This set of PDFs will be continually updated as rezonings are adopted.

### **Scanning, and Creation of Adobe PDF copies:**

Maps were scanned at 300 dpi to preserve maximum detail and originally saved to grayscale TIF image files. To facilitate viewing of the scans, they were converted to Adobe PDF format. PDFs created directly from original AutoCAD DWG files were created at 200 dpi.

### **Key To File-Naming Convention:**

Files are named with an "skz" prefix to identify them as zoning sketch maps. This prefix is followed by either a ULURP number or a CP number.

### **Copyright:**

These maps are copyrighted by the City of New York.

### **Contact Info:**

NYC Department of City Planning  
22 Reade Street, RM 3N  
New York, NY 10007  
212.720.3505 phone  
[zoning\\_gis@planning.nyc.gov](mailto:zoning_gis@planning.nyc.gov)

O.R.F.C.

A-127 C.P. 16458  
OKAP

QUEENS COLLEGE

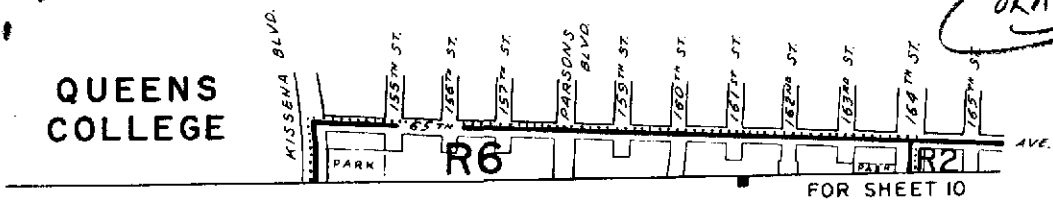

FOR SHEET 10

QUEENS COLLEGE

R4

R6

R2

R3-2

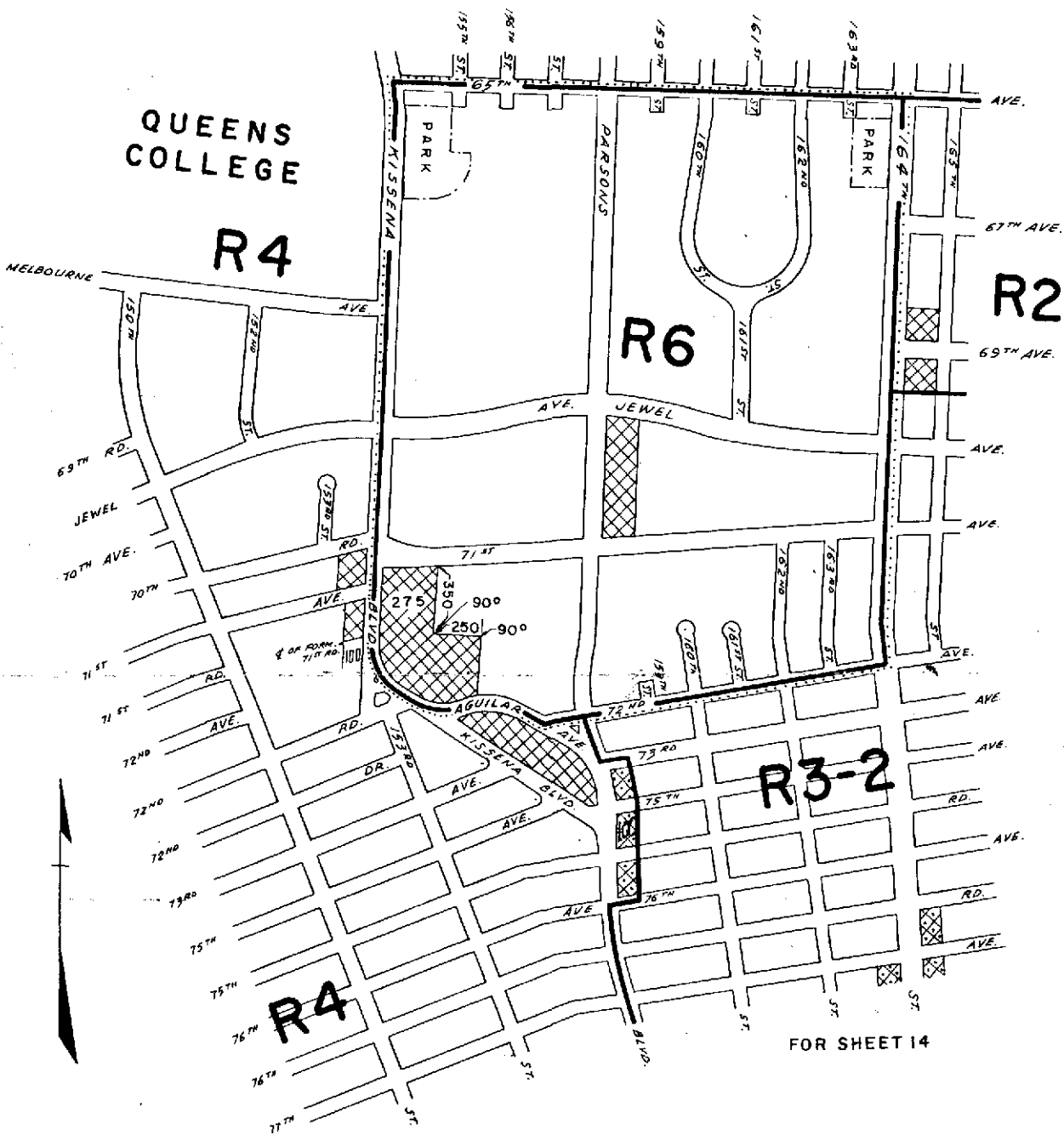

FOR SHEET 14

CITY PLANNING COMMISSION  
CITY OF NEW YORK  
**DIAGRAM SHOWING PROPOSED  
ZONING CHANGE  
ON SECTIONAL MAP**

148000 C  
BOROUGH OF  
QUEENS

New York, Sept. 13, 1961  
*Pauline Walter*  
Secretary

*Robert L. Taylor*  
Act. Director, Div. Mapping & Zoning  
*Nathan Ginsberg*  
Act. Chief, Office of Technical Controls

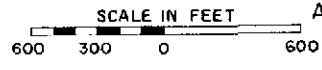

- NOTE:**
- indicates Zoning District boundary
  - ..... The area enclosed by the fine dotted line is proposed to be changed from an R4 District to an R6 District
  - ▣ indicates C1-2 District
  - ▣ indicates C2-2 District

whs

② 11/11/62



C.P. 16578

USE ENTIRE SKETCH AS PASTER

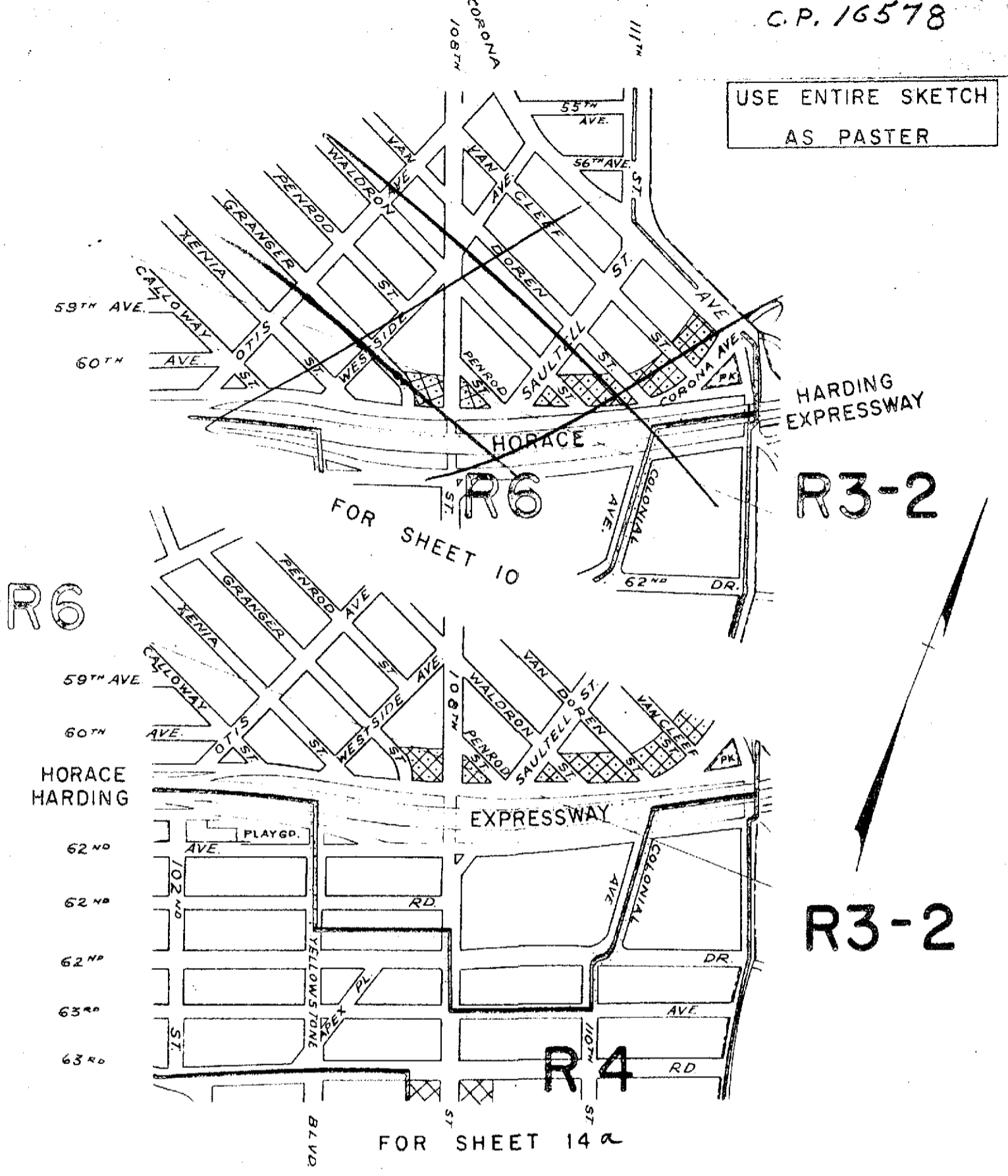

CITY PLANNING COMMISSION  
 CITY OF NEW YORK  
**DIAGRAM SHOWING PROPOSED ZONING CHANGE ON SECTIONAL MAP 10 & 14**  
 BOROUGH OF QUEENS

For sheet 14a

NEW YORK, June 14, 1961

*Marie S. Malter*  
SECRETARY

*William Ginsberg*  
 DIRECTOR, DIV. MAPPING & ZONING  
*J. F. Ashworth*  
 CHIEF, OFFICE OF TECHNICAL CONTROLS

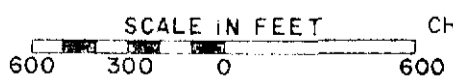

approved B. of Est 7/27/61  
 E of 12/10/61

- NOTE:
- indicates Zoning District boundary.
  - The area enclosed by the fine dotted line is proposed to be changed from an R4 indicates to an R6 District.
  - indicates -

A-49

VB

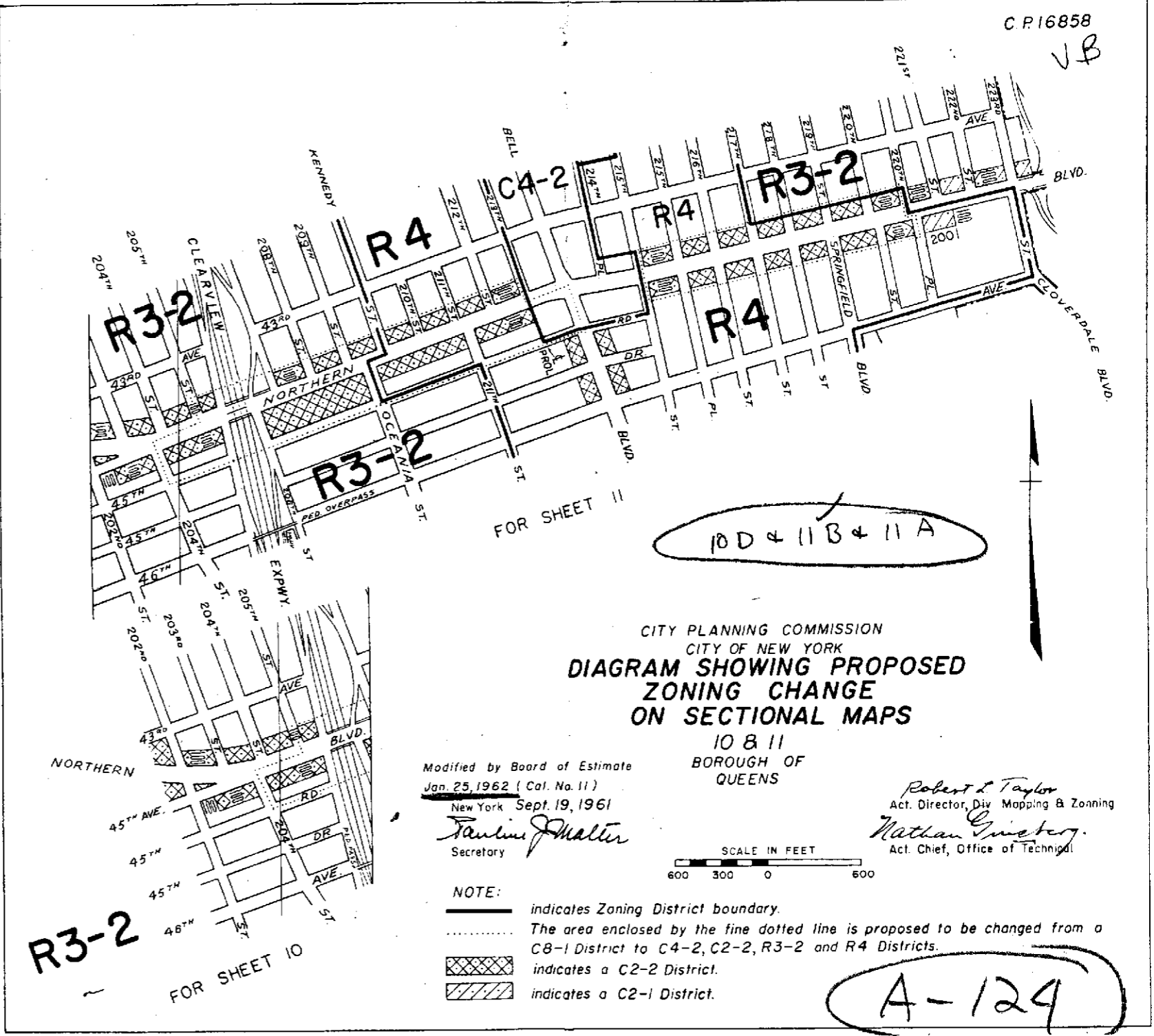

10 & 11 B & 11 A

CITY PLANNING COMMISSION  
 CITY OF NEW YORK  
**DIAGRAM SHOWING PROPOSED ZONING CHANGE ON SECTIONAL MAPS**

10 & 11  
 BOROUGH OF QUEENS

Modified by Board of Estimate  
 Jan. 25, 1962 (Cat. No. 11)  
 New York Sept. 19, 1961

*Pauline Matter*  
 Secretary

*Robert L. Taylor*  
 Act. Director, Div. Mapping & Zoning  
*Nathan Ginter*  
 Act. Chief, Office of Technical

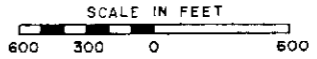

- NOTE:**
- indicates Zoning District boundary.
  - ..... The area enclosed by the fine dotted line is proposed to be changed from a C2-1 District to C4-2, C2-2, R3-2 and R4 Districts.
  - indicates a C2-2 District.
  - indicates a C2-1 District.

A-124

FOR SHEET 11

R3-2  
FOR SHEET 10

A-177

C.P. 17066

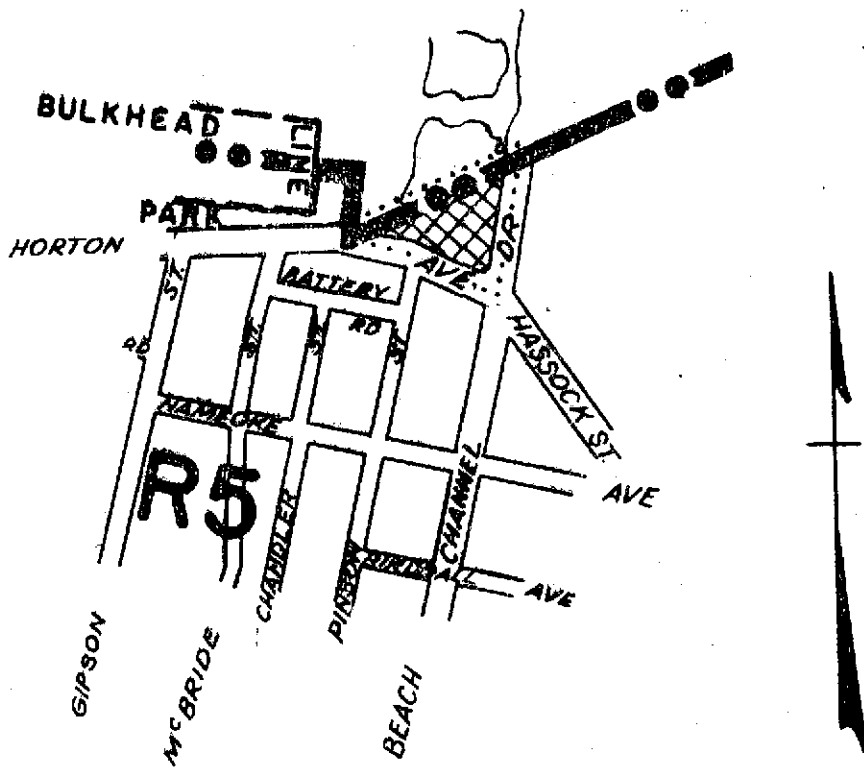

JE  
AP

CITY PLANNING COMMISSION  
 CITY OF NEW YORK  
 DIAGRAM SHOWING PROPOSED  
 ZONING CHANGE  
 ON SECTIONAL MAP

25 b

BOROUGH OF  
QUEENS

New York, January 3, 1962

*Faustine J. Matter*  
Secretary



*Nathan Ginsberg*  
Director, Div. Mapping & Zoning

*J. F. Ashworth*  
Chief, Office of Technical Controls

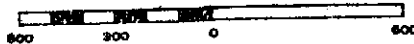
SCALE IN FEET



**NOTE:**

-  indicates Zoning District boundary.
-  The area enclosed by the fine dotted line is proposed to be changed by establishing a C1-2 District within an existing R5 District.
-  indicates C1-2 District.

*CSM 14 W*

*L.V. Bow*

MARCH 22 1962

*Eff 3-22-62*

J.V.F.

V.F.  
AP

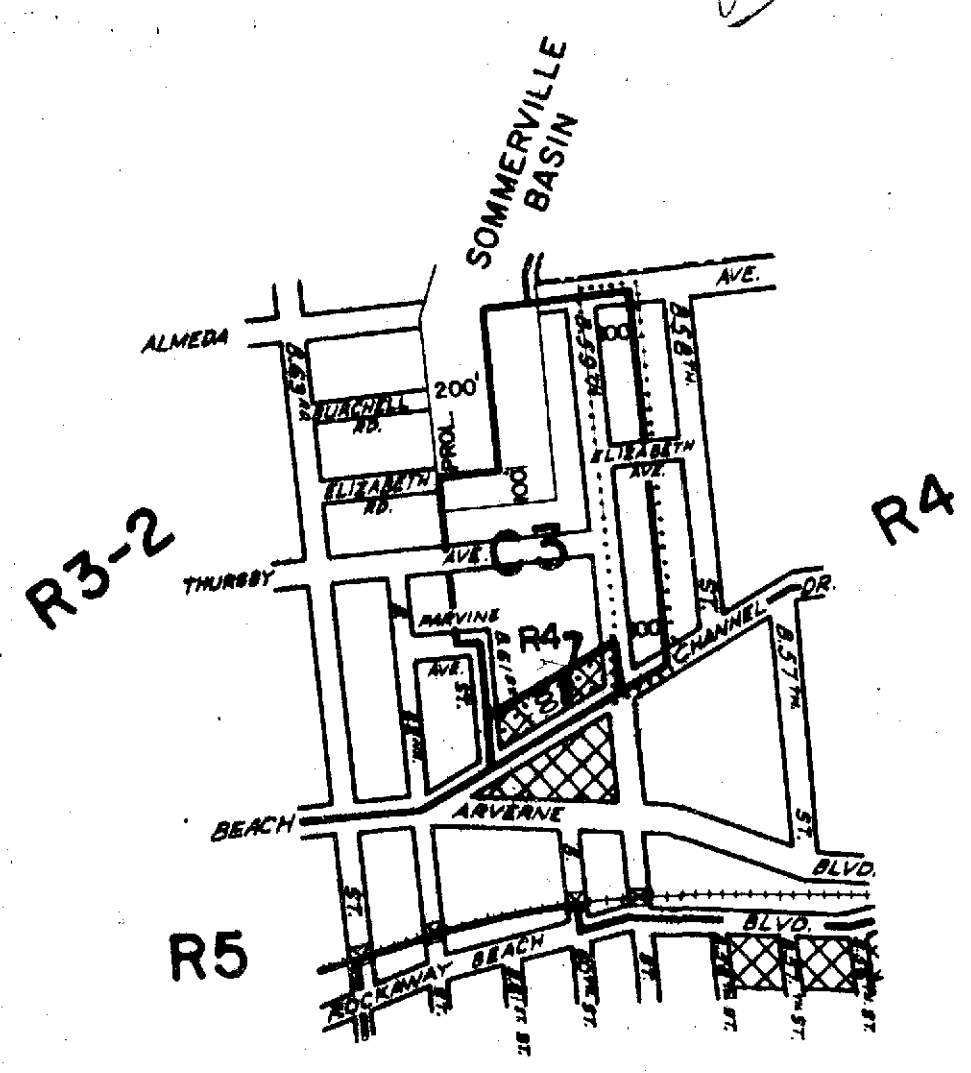

CITY PLANNING COMMISSION  
CITY OF NEW YORK  
**DIAGRAM SHOWING PROPOSED  
ZONING CHANGE  
ON SECTIONAL MAP**  
30C  
BOROUGH OF  
QUEENS

New York, JANUARY 3, 1962  
*Pauline Matter*  
Secretary

*Nathan Ginsberg*  
Director, Div. Mapping & Zoning  
*J.F. Ashworth*  
Chief, Office of Technical Controls

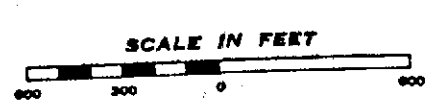

- NOTE:**
- indicates Zoning District boundary.
  - The area enclosed by the fine dotted line is proposed to be changed from R4 District to an C3 District.
  - indicates a C1-2 District
  - indicates an C2-2 Districts.

*EPB* 3-22-64

A 214

C.P. 17237

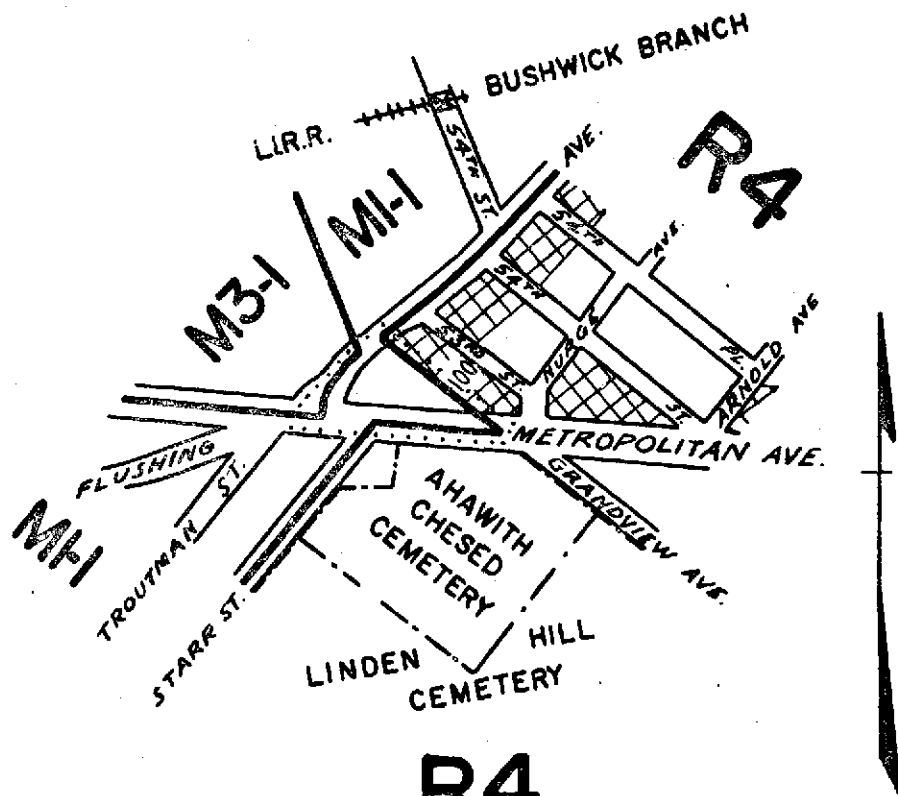

**R4**  
 CITY PLANNING COMMISSION  
 CITY OF NEW YORK  
 DIAGRAM SHOWING PROPOSED  
 ZONING CHANGE  
 ON SECTIONAL MAP

**13b**  
 BOROUGH OF  
 QUEENS

New York, March 14, 1962

*Pauline J. Malin*  
 Secretary

*Nathan Ginsberg*  
 Director, Div. Mapping & Zoning  
*J. F. Ashworth*  
 Chief, Office of Technical Controls



**NOTE:**

- indicates Zoning District boundary.
- The area enclosed by the fine dotted line is proposed to be changed from R4 and CI-2 Districts to an M1-1 District.
- indicates a CI-2 District.

*all changes R4*

L.O

C. P. 17260

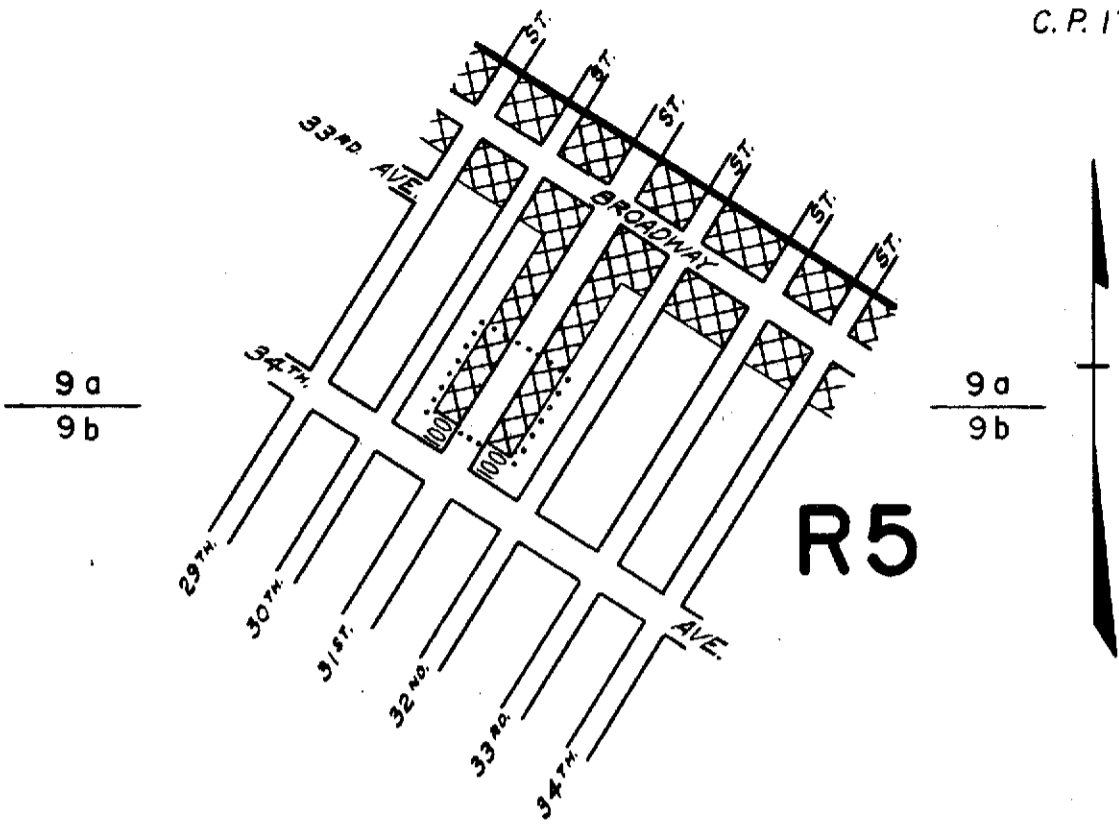

CITY PLANNING COMMISSION  
 CITY OF NEW YORK  
**DIAGRAM SHOWING PROPOSED  
 ZONING CHANGE  
 ON SECTIONAL MAPS  
 9a & 9b**  
 BOROUGH OF  
 QUEENS

New York, MARCH 28, 1962

Acting Secretary *W. Goldstein*

*Frank De Filippo*  
 Director, Division of Zoning  
*J. F. Ashworth*  
 Chief, Office of Technical Controls

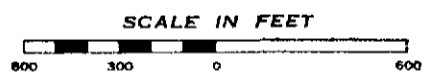

- NOTE:**
- indicates Zoning District boundary.
  - The area enclosed by the fine dotted line is proposed to be changed by establishing a C1-2 District within an existing R5 District.
  - indicates a C1-2 District.

J.B.

A-220

A. 2/12  
AP

C.P. 17281

V.B.

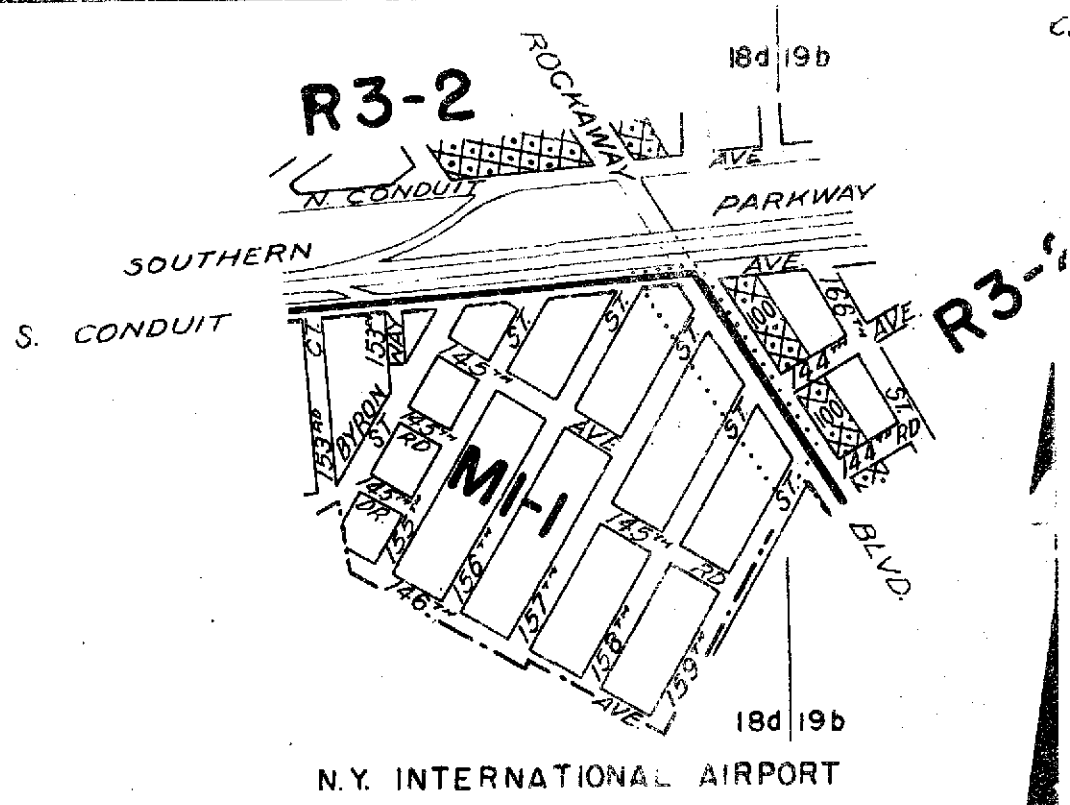

CITY PLANNING COMMISSION  
CITY OF NEW YORK  
**DIAGRAM SHOWING PROPOSED  
ZONING CHANGE  
ON SECTIONAL MAP  
18d & 19b  
BOROUGH OF  
QUEENS**

New York, April 13, 1962  
*Pauline J. Feller*  
Secretary

*Frank De Filippo*  
Director, Division of Zoning  
*J. F. Ashworth*  
Chief, Office of Technical Control

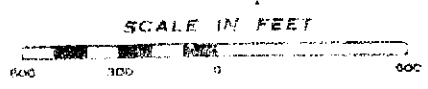

- NOTE:**
- indicates Zoning District boundary.
  - ..... The area enclosed by the fine dotted line is proposed to be changed from C2-2 and R3-2 Districts to an MI-1 District
  - ▣ indicates a C2-2 District

*CLM*

*date 5/24/62*

A 232

C. P. 17388

# RI-2

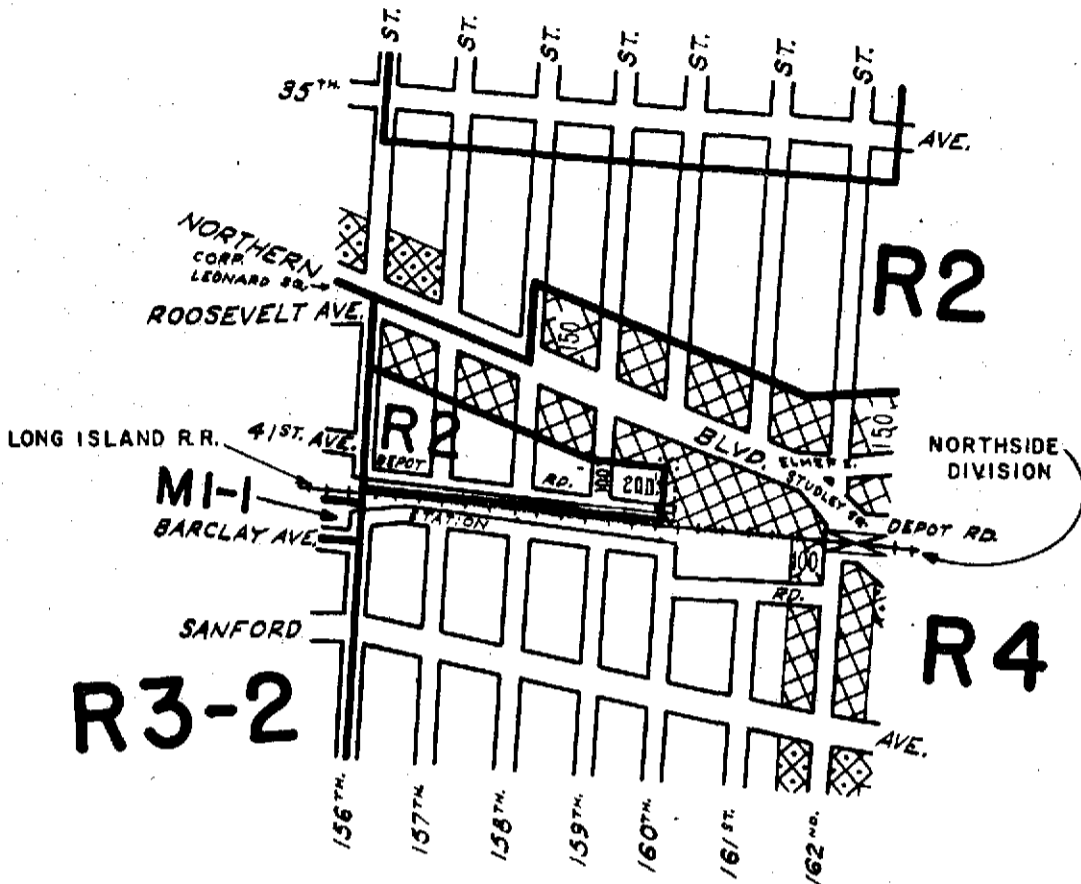

CITY PLANNING COMMISSION  
 CITY OF NEW YORK  
**DIAGRAM SHOWING PROPOSED  
 ZONING CHANGE  
 ON SECTIONAL MAP**

10c

BOROUGH OF  
QUEENS

*Frank De Filippo*  
 Director, Division of Zoning





*J. F. Ashworth*  
 Chief, Office of Technical Controls

New York, JUNE 13, 1962

*Sauline J. Malter*  
 Secretary

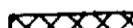

**NOTE:**

-  indicates Zoning District boundary.
-  The area enclosed by the fine dotted line is proposed to be changed from an R2 District to a C1-2 District within an R4 District.
-  indicates a C1-2 District.
-  indicates a C2-2 District.

J.B.

*Eff 7/26/62*  
*[Signature]*



A239

C. P. 17392

FL

R3-1

AP  
VB  
T-2

R5

R5

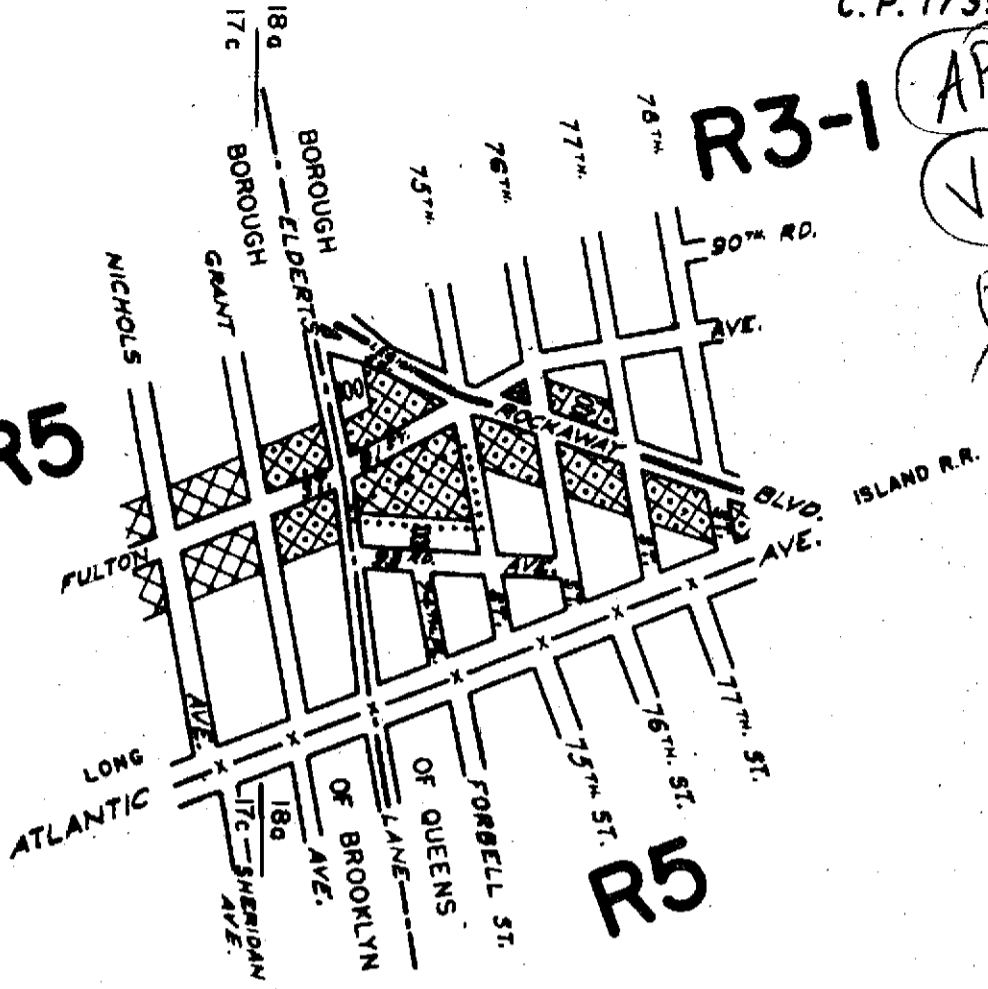

CITY PLANNING COMMISSION  
 CITY OF NEW YORK  
**DIAGRAM SHOWING PROPOSED  
 ZONING CHANGE  
 ON SECTIONAL MAP**

18a ✓  
 BOROUGH OF  
 QUEENS

New York, JUNE 27, 1962



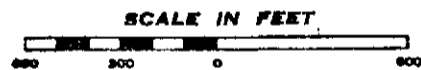

*Pauline J. Malin*  
 Secretary

*Frank DeFilippo*  
 Director, Division of Zoning

*J. F. Ashworth*  
 Chief, Office of Technical Controls



**NOTE:**

-  indicates Zoning District boundary.
-  The area enclosed by the fine dotted line is proposed to be changed by establishing a C2-2 District within an R5 District.
-  indicates a C2-2 District.
-  Indicates a C1-2 District.

J.B. 9/27/62

✓ 9/27/62

A240

FC

C.P. 1741A  
AP

IB

JOE

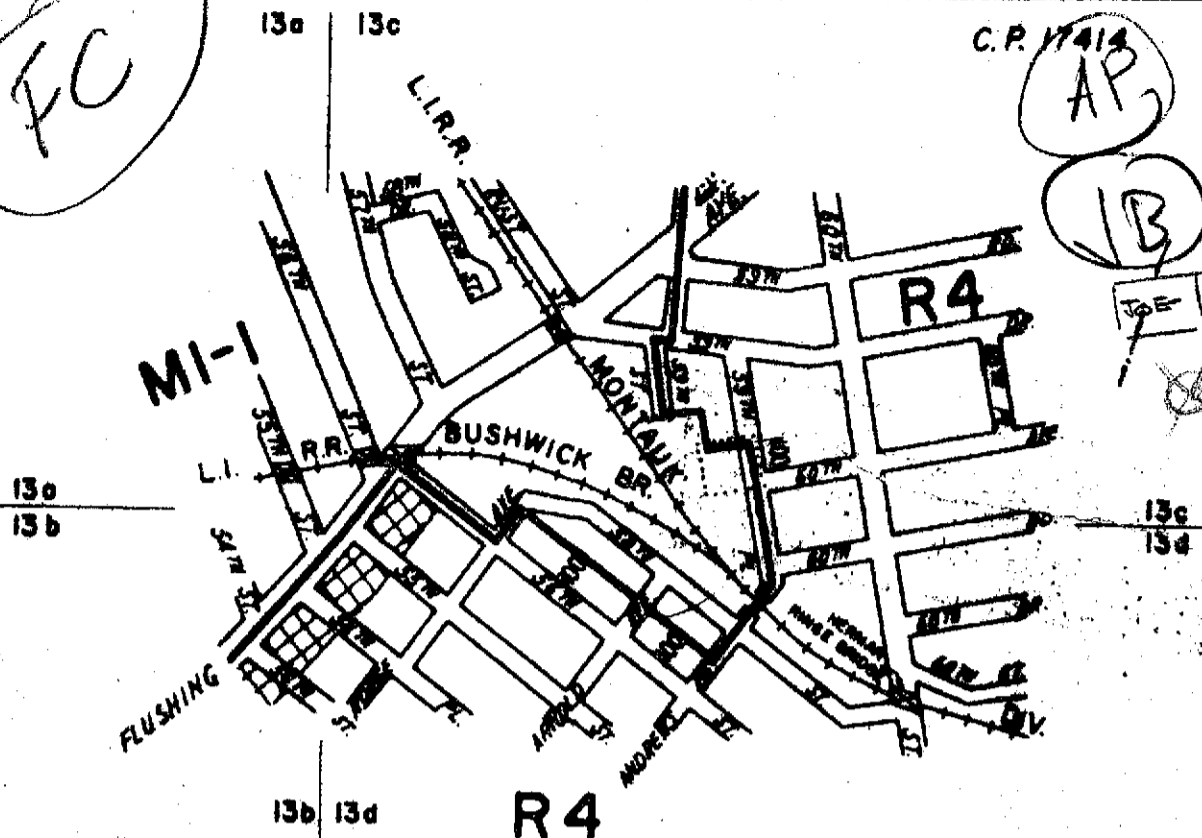





**CITY PLANNING COMMISSION  
CITY OF NEW YORK  
DIAGRAM SHOWING PROPOSED  
ZONING CHANGE  
ON SECTIONAL MAP**

**13c**  
**BOROUGH OF  
QUEENS**

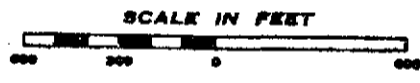
New York, June 27, 1962  
*Pauline Walter*  
Secretary

*Frank De Filippo*  
Director, Division of Zoning  
*J. F. Ashworth*  
Chief, Office of Technical Controls



- NOTE:**
-  indicates Zoning District boundary.
  -  The area enclosed by the fine dotted line is proposed to be changed from an R-4 District to an MI-1 District.
  -  indicates C1-2 District
  -  indicates C2-2 District

7-167 W

10/11/62  
9/27/62

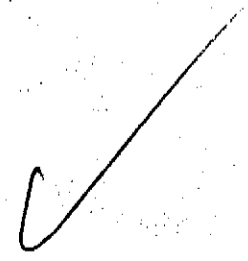

A253 ✓

C.P. 17452

AP

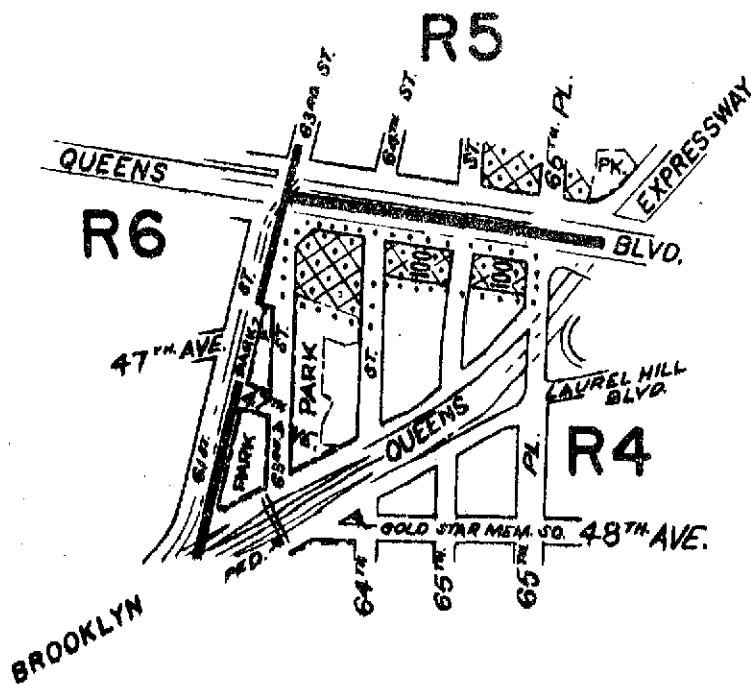

**CITY PLANNING COMMISSION  
CITY OF NEW YORK  
DIAGRAM SHOWING PROPOSED  
ZONING CHANGE  
ON SECTIONAL MAP**

**9 d  
BOROUGH OF  
QUEENS**

New York, AUGUST 14, 1962



*Pauline J. Malter*  
Secretary

*Frank De Felippa*  
Director, Division of Zoning

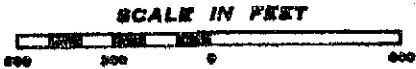
*J.F. Ashworth*  
Chief, Office of Technical Controls



**NOTE:**

-  indicates Zoning District boundary.
-  The area enclosed by the fine dotted line is proposed to be changed by the establishment of a C2-2 District within an existing R4 District.
-  Indicates a C2-2 District.

RC. 102 ✓

Sl. 5

10/11/6 ✓

Rush

A-260

C.P. 17456

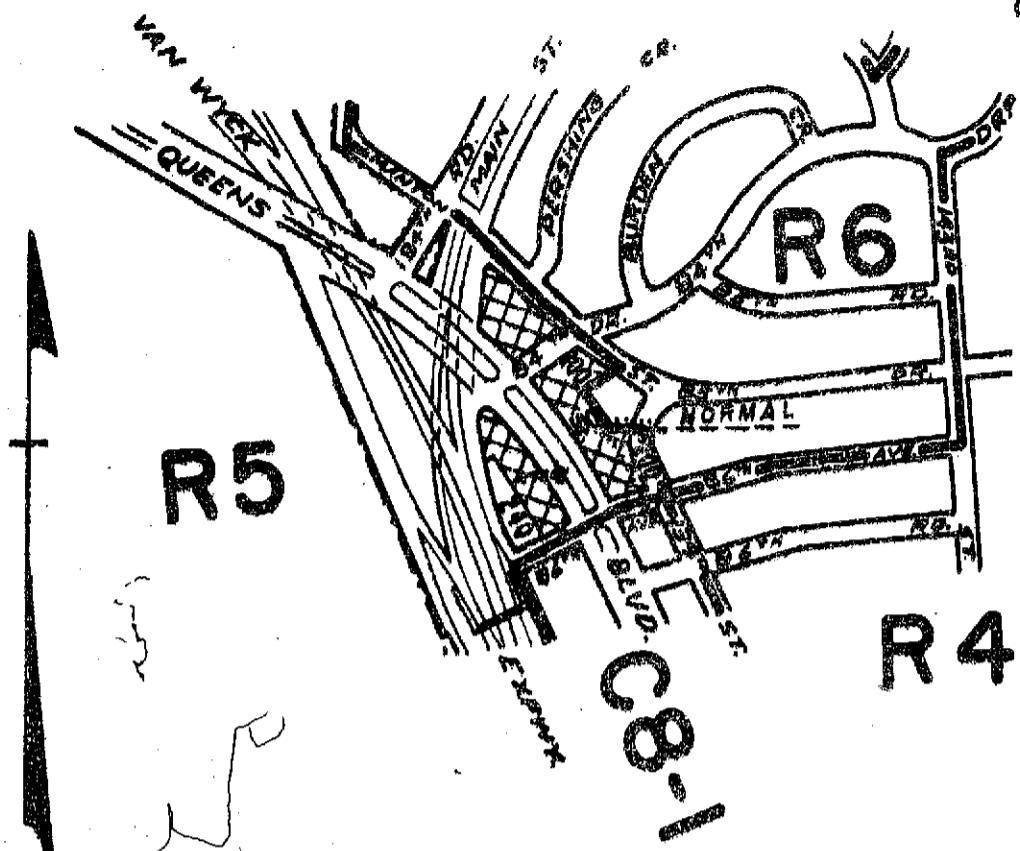

CITY PLANNING COMMISSION  
 CITY OF NEW YORK  
**DIAGRAM SHOWING PROPOSED  
 ZONING CHANGE  
 ON SECTIONAL MAP  
 14d**

BOROUGH OF  
 QUEENS

New York, August 14, 1962

*Fantine J. Malin*  
 Secretary

*Frank De Filippo*  
 Director, Division of Zoning

*J. F. Ashworth*  
 Chief, Office of Technical Control

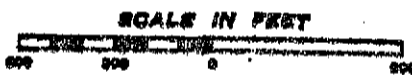

**NOTE:**

- Indicates Zoning District boundary.
- The area enclosed by the fine dotted line is proposed to be changed from an R6 District to an R5 District and establishing a CI-2 District therein.
- Indicates a CI-2 District.

N.A.P. J per RR.

11/21/62 ✓

Rush

OK A261

C.P. 17513

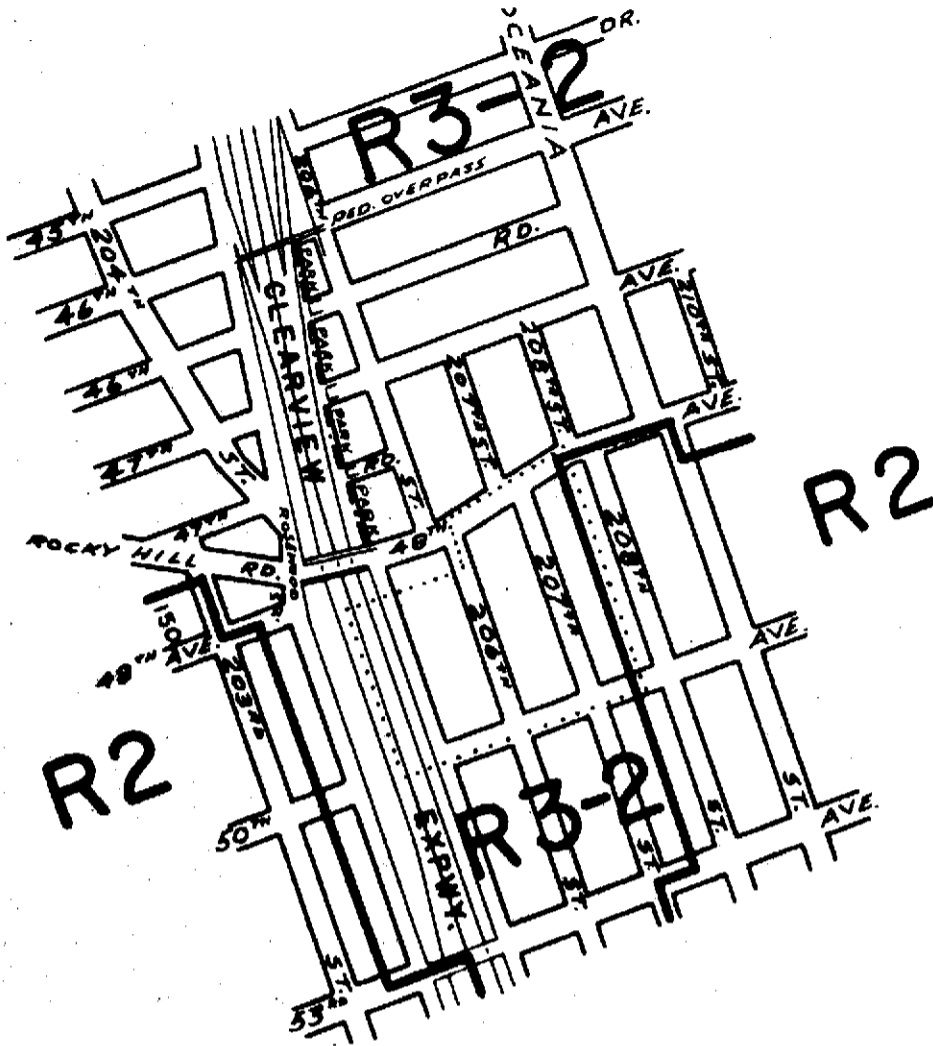

CITY PLANNING COMMISSION  
 CITY OF NEW YORK  
 DIAGRAM SHOWING PROPOSED  
 ZONING CHANGE  
 ON SECTIONAL MAP

11b  
 BOROUGH OF  
 QUEENS

New York, September 19, 1962

*Pauline Matter*  
 Secretary

*Frank DeFilippo*  
 Director, Division of Zoning  
*J. F. Ashworth*  
 Chief, Office of Technical Controls

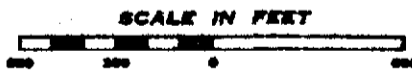

NOTE:

- indicates Zoning District boundary.
- ..... The area enclosed by the fine dotted line is proposed to be changed from an R2 District to an R3-2 District.

N.A.P. F.L. RR ✓

11/21/62 ✓

*Push*

*80 A262*

C. P. 17516



*51*

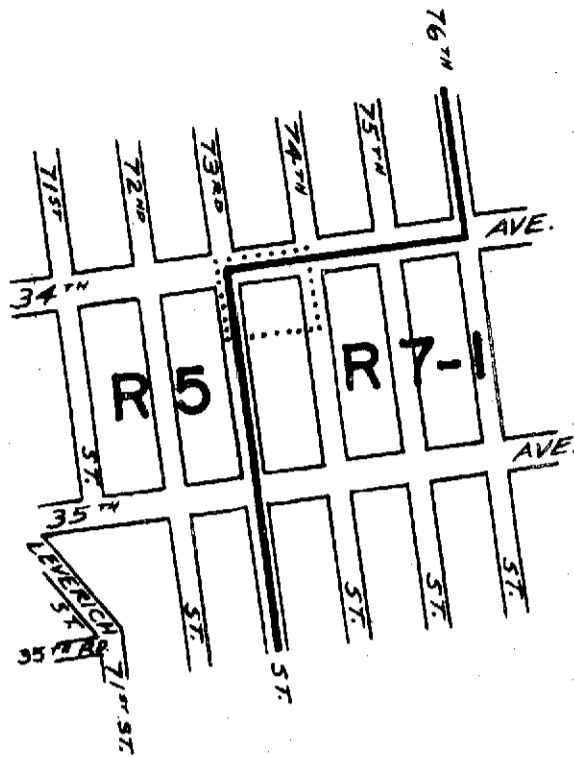

CITY PLANNING COMMISSION  
 CITY OF NEW YORK  
**DIAGRAM SHOWING PROPOSED  
 ZONING CHANGE  
 ON SECTIONAL MAP**

*9d*

BOROUGH OF  
QUEENS

New York, September 19, 1962

*Stanley Miller*  
 Secretary

*Frank De Filippo*  
 Director, Division of Zoning

*J. F. Ashworth*  
 Chief, Office of Technical Controls

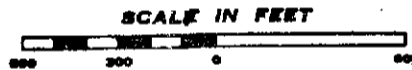

**NOTE:**

- indicates Zoning District boundary.
- .....** The area enclosed by the fine dotted line is proposed to be changed from an R5 District to an R7-1 District.

*C.H. F...*

*NOV 21, 1962*

A269

C.P. 17518

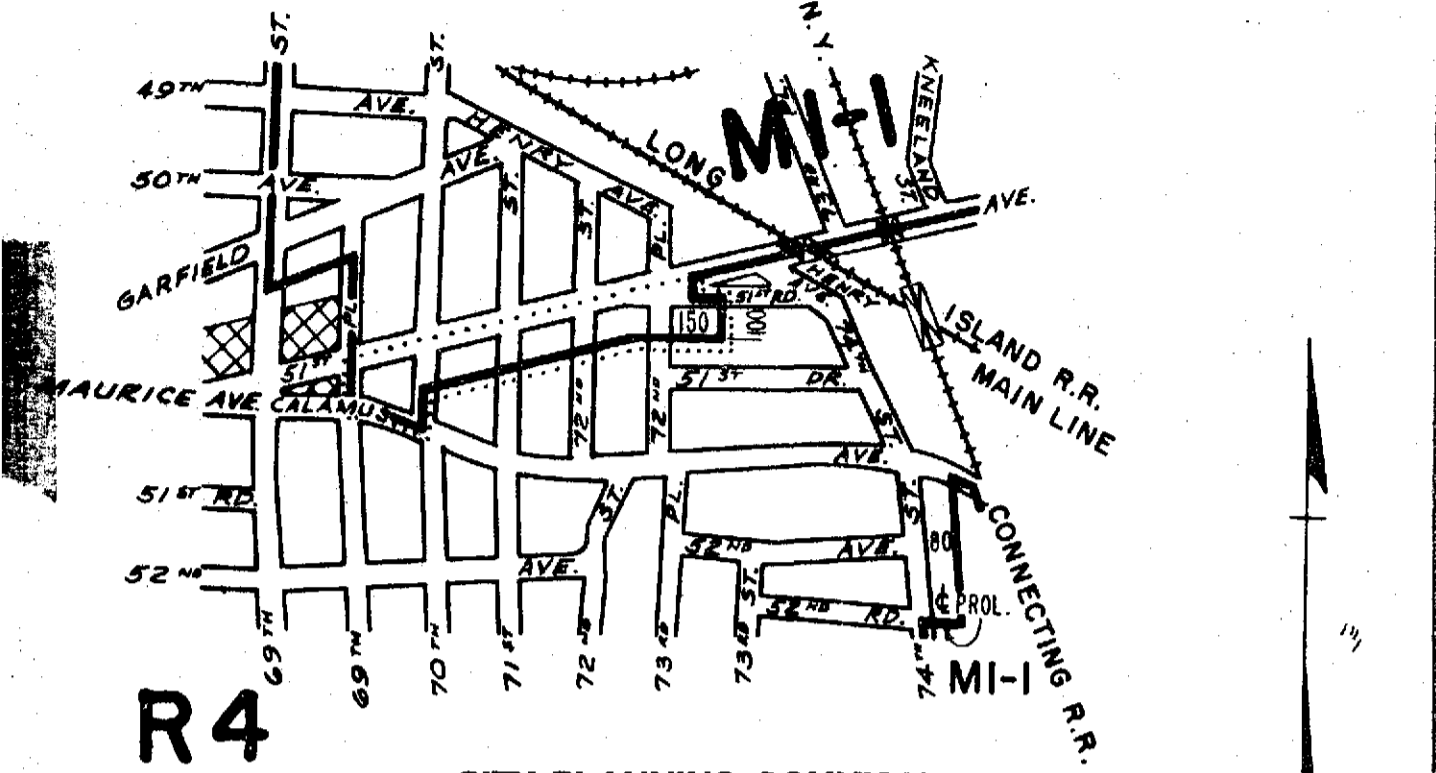

R4

CITY PLANNING COMMISSION  
 CITY OF NEW YORK  
 DIAGRAM SHOWING PROPOSED  
 ZONING CHANGE  
 ON SECTIONAL MAP  
 13c ✓

BOROUGH OF QUEENS

New York, September 19, 1962

*Pauline Matter*  
 Secretary

*Frank De Filippo*  
 Director, Division of Zoning

*J. F. Ashworth*  
 Chief, Office of Technical Controls

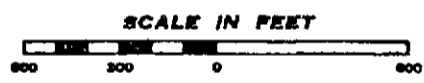

NOTE:

- indicates Zoning District boundary.
- ..... The area enclosed by the fine dotted line is proposed to be changed from an R4 District to an MI-1 District.
- XXXXXX indicates a C1-2 District.

ST. F.L.



A 259

C.P. 17519-7  
AP

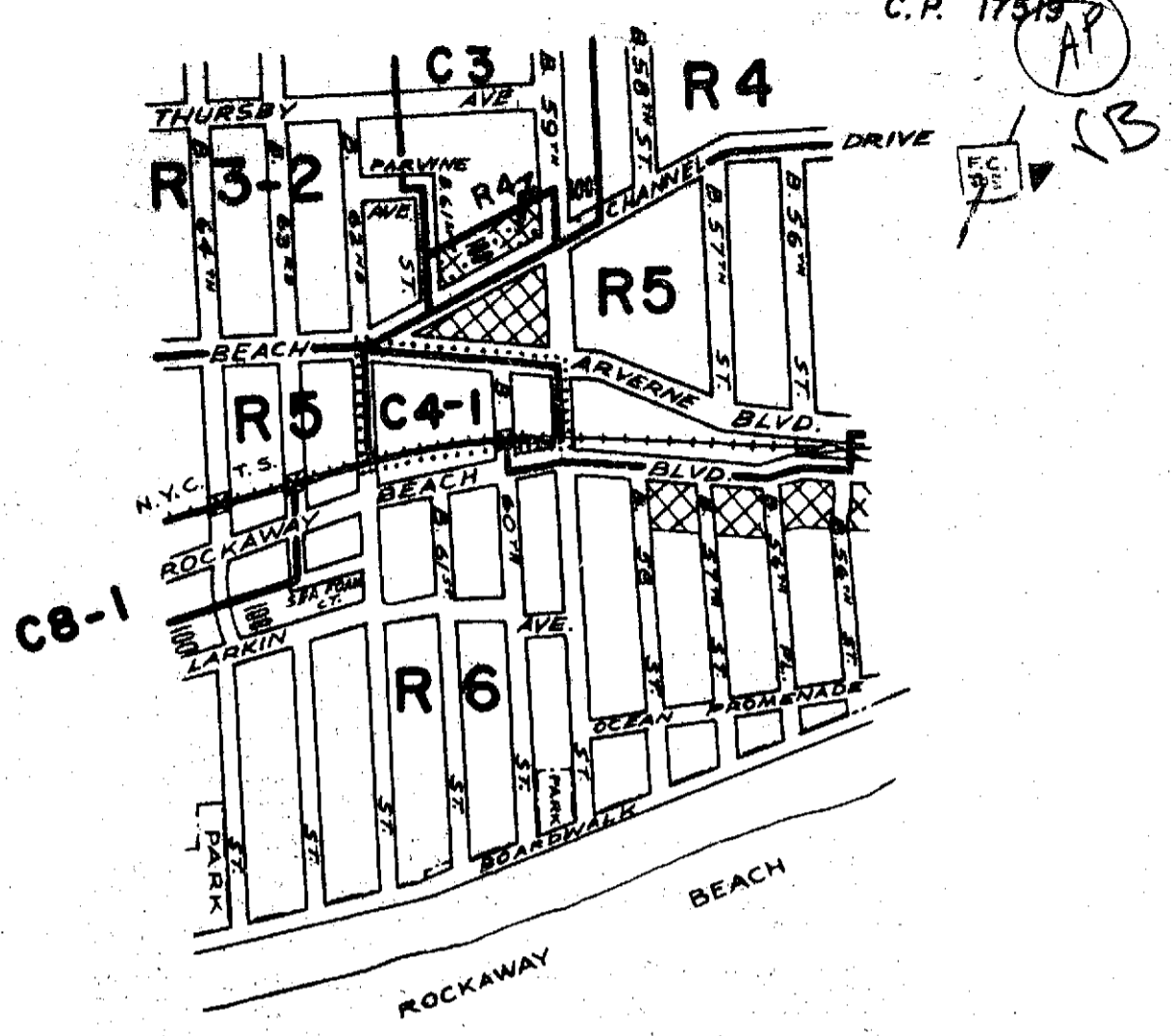

CITY PLANNING COMMISSION  
CITY OF NEW YORK  
**DIAGRAM SHOWING PROPOSED  
ZONING CHANGE  
ON SECTIONAL MAP**

30c ✓

BOROUGH OF  
QUEENS

*Frank De Filippo*  
Director, Division of Zoning

*J. F. Ashworth*  
Chief, Office of Technical Controls

New York, September 19, 1962

*Fauling Martin*  
Secretary

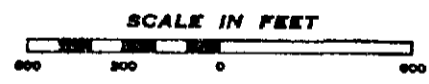

**NOTE:**

- indicates Zoning District boundary.
- The area enclosed by the fine dotted line is proposed to be changed from an R5 District to a C4-1 District.
- indicates a C1-2 District.
- indicates a C2-2 District.

C.H. DC FR W



Rush

A 263  
J.F. 17529

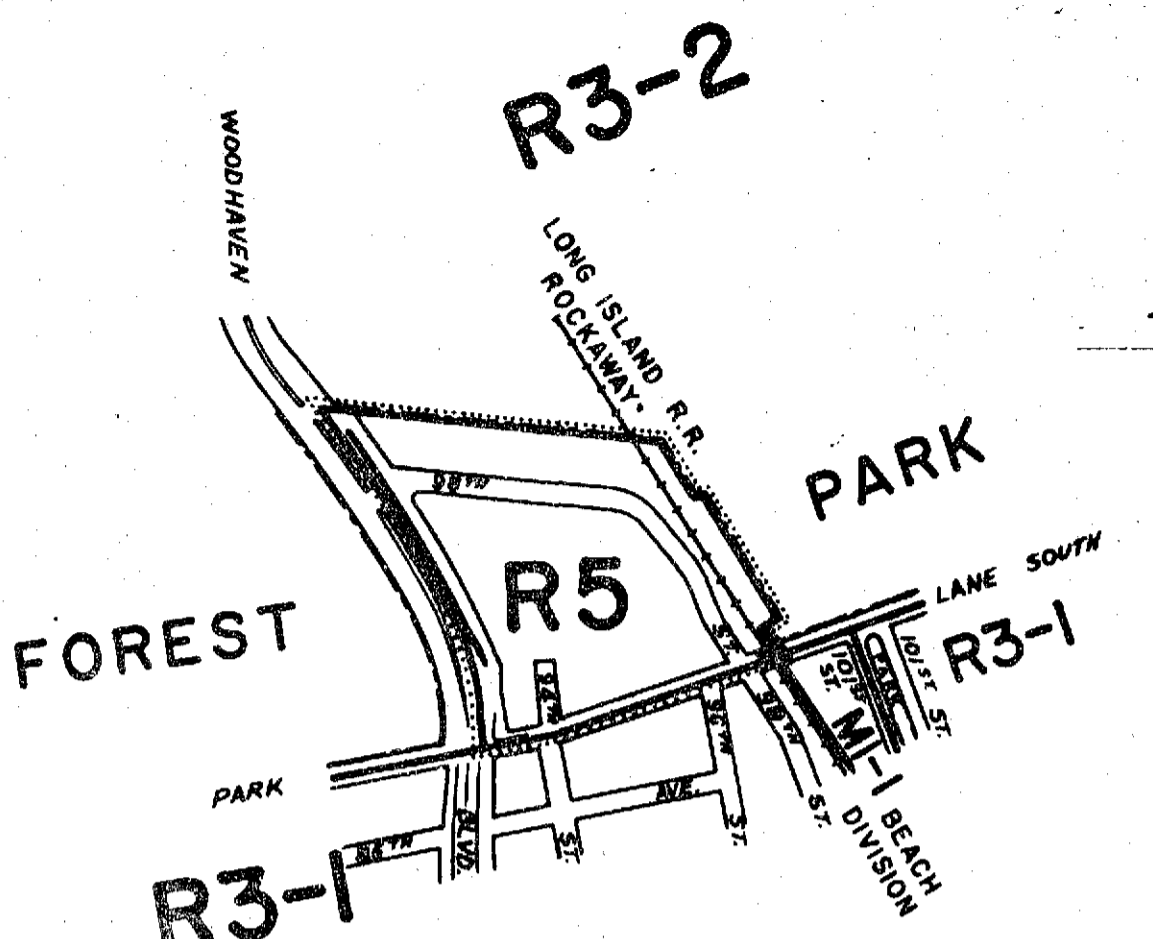

CITY PLANNING COMMISSION  
 CITY OF NEW YORK  
**DIAGRAM SHOWING PROPOSED  
 ZONING CHANGE  
 ON SECTIONAL MAP  
 14 b**  
 BOROUGH OF  
 QUEENS

New York, Sept. 19, 1962

*Tauline Matter*  
Secretary

*Frank De Filippo*  
Director, Division of Zoning

*J. F. Ashworth*  
Chief, Office of Technical Controls



**NOTE:**

- indicates Zoning District boundary.
- ..... The area enclosed by the fine dotted line is proposed to be changed from an R3-2 District to an R5 District.

F.J.L. F.L. V.R. W

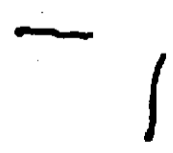
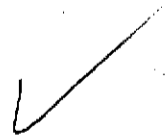

07

A277

C.P. 17539

OKAP

VB

FC

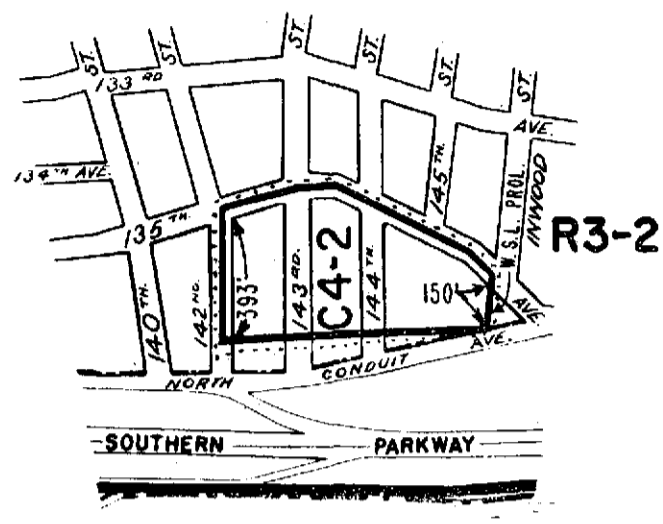

CITY PLANNING COMMISSION  
 CITY OF NEW YORK  
 DIAGRAM SHOWING PROPOSED  
 ZONING CHANGE  
 ON SECTIONAL MAP

18d

BOROUGH OF  
QUEENS

New York, October 3, 1962

*Pauline Matter*  
Secretary

*Louis Roberti*  
Acting Director, Division of Zoning

*J. F. Ashworth*  
Chief, Office of Technical Controls



**NOTE:**

- indicates Zoning District boundary.
- .....** The area enclosed by the fine dotted line is proposed to be changed from an R3-2 District to a C4-2 District.

R.C.



1

OK

A 278

C.P. 17550

OKAP

VB  
4U

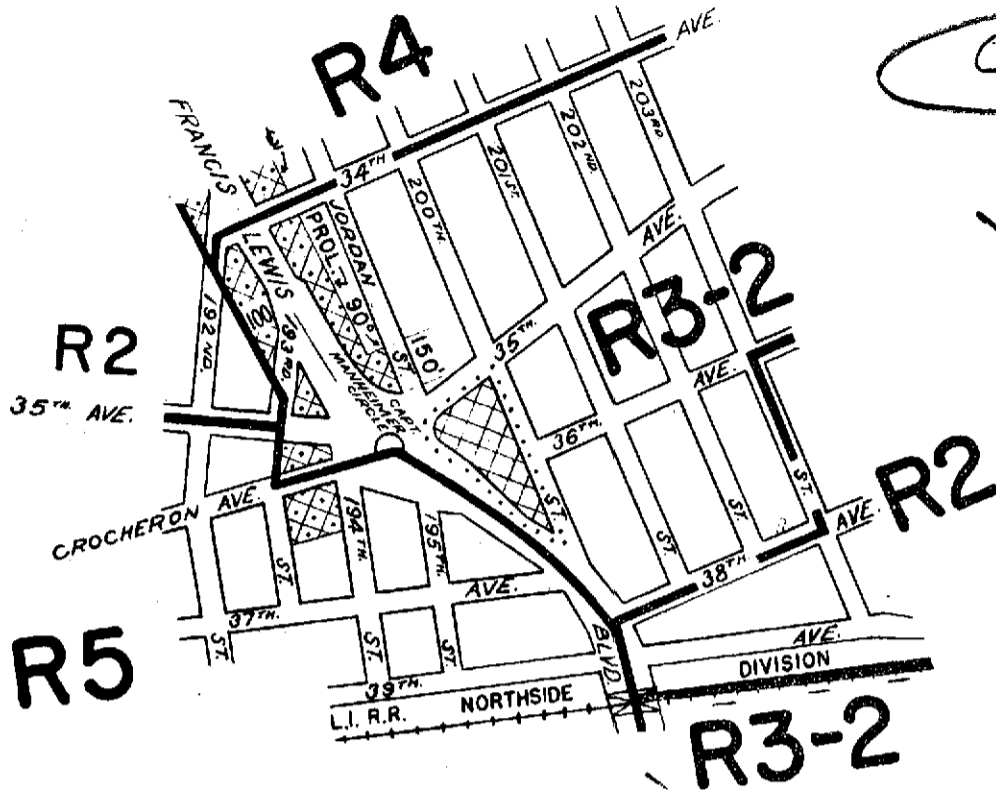

CITY PLANNING COMMISSION  
 CITY OF NEW YORK  
 DIAGRAM SHOWING PROPOSED  
 ZONING CHANGE  
 ON SECTIONAL MAP

✓ 10 c  
 BOROUGH OF  
 QUEENS

New York, October 3, 1962

*Pauline Mueller*  
 Secretary

*Frank De Filippo*  
 Director, Division of Zoning

*J. F. Ashworth*  
 Chief, Office of Technical Controls

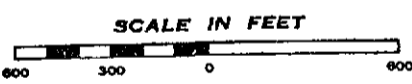

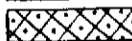
- NOTE:**
- indicates Zoning District boundary.
  - ..... The area enclosed by the fine dotted line is proposed to be changed by the establishment of a CI-2 District within an existing R3-2 District.
  -  indicates a CI-2 District.
  -  indicates a C2-2 District.

R.C.

A270

C. P. 17551

R4

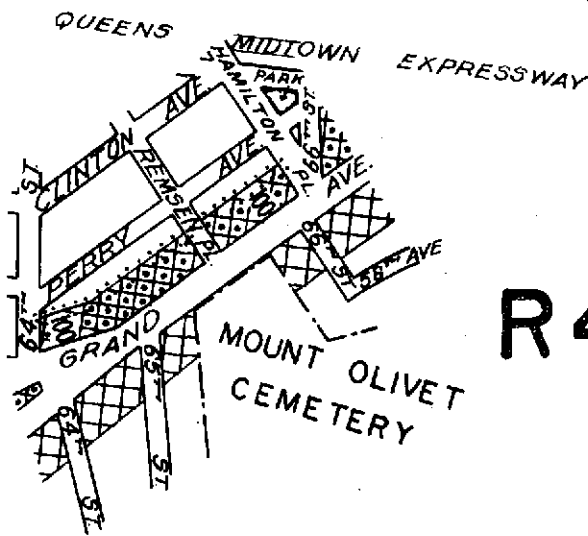

R4

CITY PLANNING COMMISSION  
 CITY OF NEW YORK  
 DIAGRAM SHOWING PROPOSED  
 ZONING CHANGE  
 ON SECTIONAL MAP

13c  
 BOROUGH OF  
 QUEENS



New York, October 3, 1962





*Samuel J. Walter*  
 Secretary

*Frank De Filippo*  
 Director, Division of Zoning

*J. F. Ashworth*  
 Chief, Office of Technical Controls



**NOTE:**

-  indicates Zoning District boundary.
-  The area enclosed by the fine dotted line is proposed to be changed by the establishment of a C2-2 District within an existing R4 District.
-  indicates a C1-2 District.
-  indicates a C2-2 District.

*CSM*

LO

*Handwritten initials*

C. P. 17566

OKAP

JB

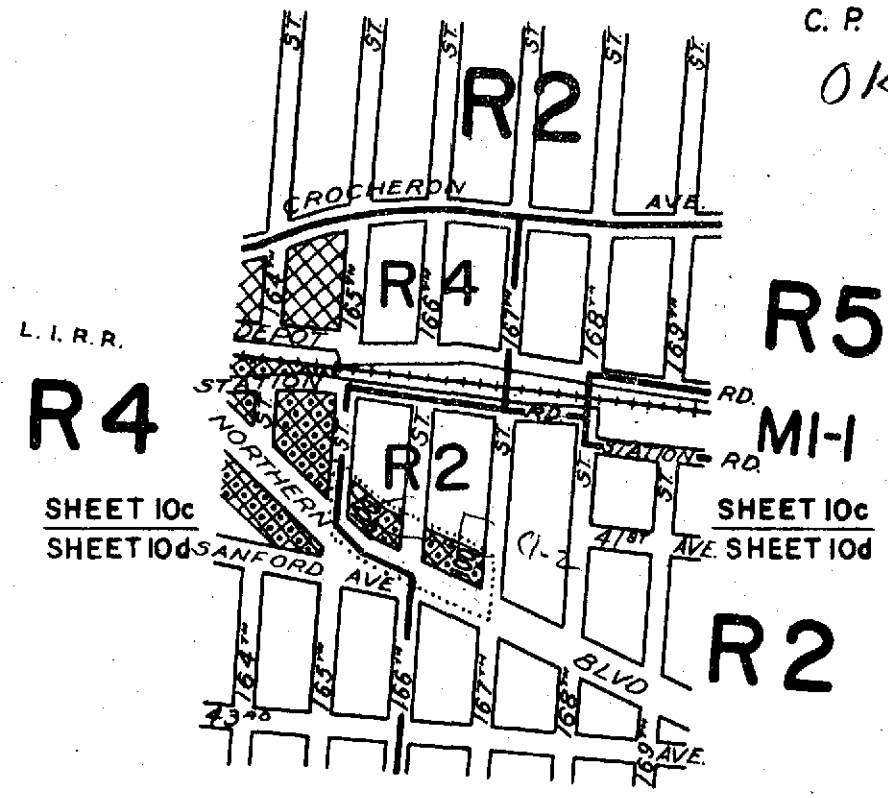
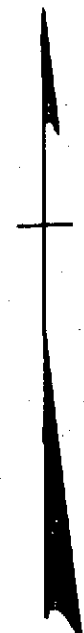

CITY PLANNING COMMISSION  
 CITY OF NEW YORK  
**DIAGRAM SHOWING PROPOSED  
 ZONING CHANGE  
 ON SECTIONAL MAPS  
 10c,d**

Mod. Bd of Est. Jan 24/63 (Cal No. 43)  
 BOROUGH OF QUEENS  
 New York, October 17, 1962

*Pauline J. Maltz*  
 Secretary

*Louis Roberts*  
 Acting Director, Division of Zoning

*Nathan Ginsberg*  
 Acting Chief, Office of Technical Controls



- NOTE:**
- indicates Zoning District boundary.
  - ..... The area enclosed by the fine dotted line is proposed to be changed by the establishment of a C1-2 District in an existing R2 District.
  - indicates a C1-2 District
  - indicates a C2-2 District.

F.L. csm. RB N

A-290

L.O. 1/24/63

JAN, 24, 1963

modification  
 make - C1-2 not C2-2

C.R. 17572

OKAP

VB

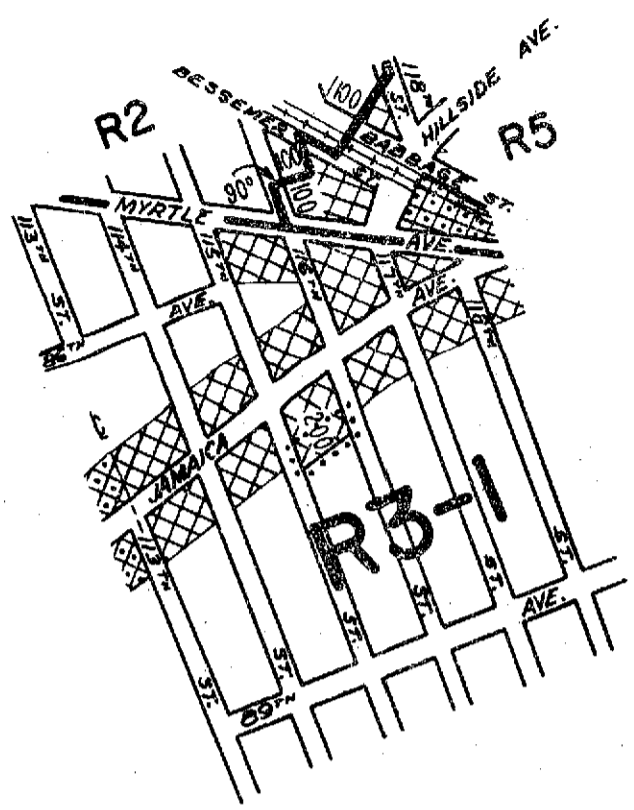

CITY PLANNING COMMISSION  
 CITY OF NEW YORK  
 DIAGRAM SHOWING PROPOSED  
 ZONING CHANGE  
 ON SECTIONAL MAP

14b

BOROUGH OF  
QUEENS

New York, October 17, 1962



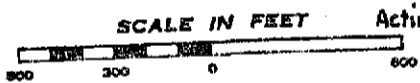

*Pauline J. Matlin*  
 Secretary

*Louis Roberts*  
 Acting Director, Division of Zoning

*Nathan Ginsberg*  
 Acting Chief, Office of Technical Controls



NOTE:

-  indicates Zoning District boundary.
-  The area enclosed by the fine dotted line is proposed to be changed by establishing a C1-2 District within an existing R3-1 District.
-  indicates a C1-2 District.
-  indicates a C2-2 District.

F.L. A.P.

L.O. 1/24/63

A-291  
 JAN 24, 1963

A 276

C.P. 17591

OKAP

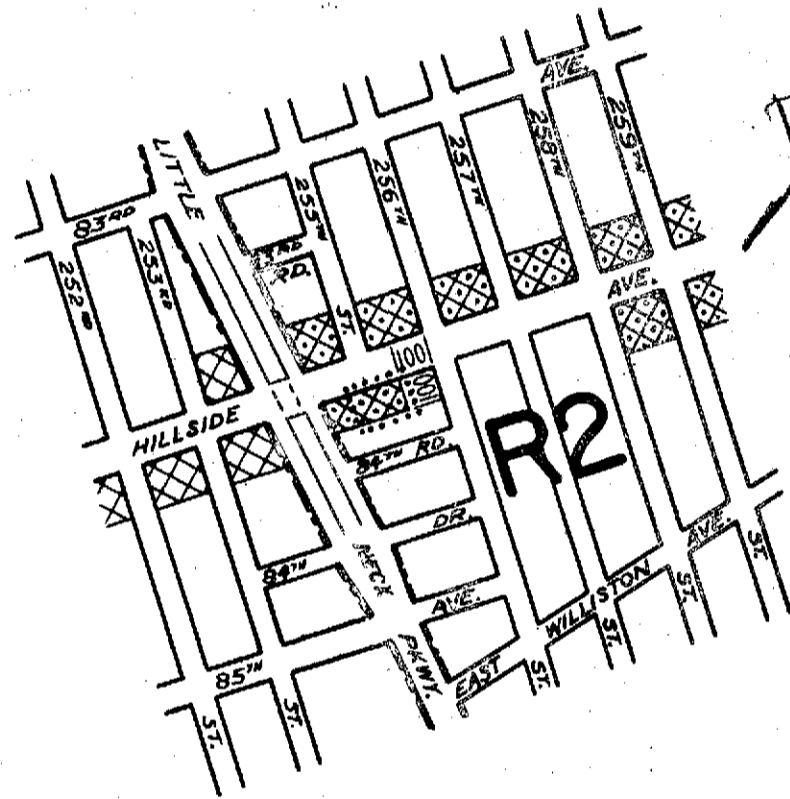
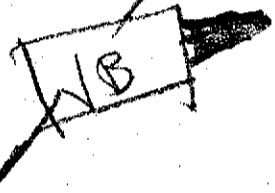

CITY PLANNING COMMISSION  
CITY OF NEW YORK  
DIAGRAM SHOWING PROPOSED  
ZONING CHANGE  
ON SECTIONAL MAP





15c  
BOROUGH OF  
QUEENS

New York, October 17, 1962

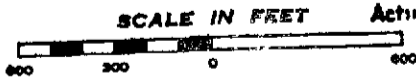
*Pauline J. Walter*  
Secretary

*Louis Roberts*  
Acting Director, Division of Zoning  
*Nathan Ginsberg*  
Acting Chief, Office of Technical Controls



- NOTE:**
-  indicates Zoning District boundary.
  -  The area enclosed by the fine dotted line is proposed to be changed by establishing a C2-2 District within an existing R2 District.
  -  indicates a C1-2 District.
  -  indicates a C2-2 District.

A.P. F.L. W

225

2.0 to 1/10/63

C.P. 17622

OKAP

VB

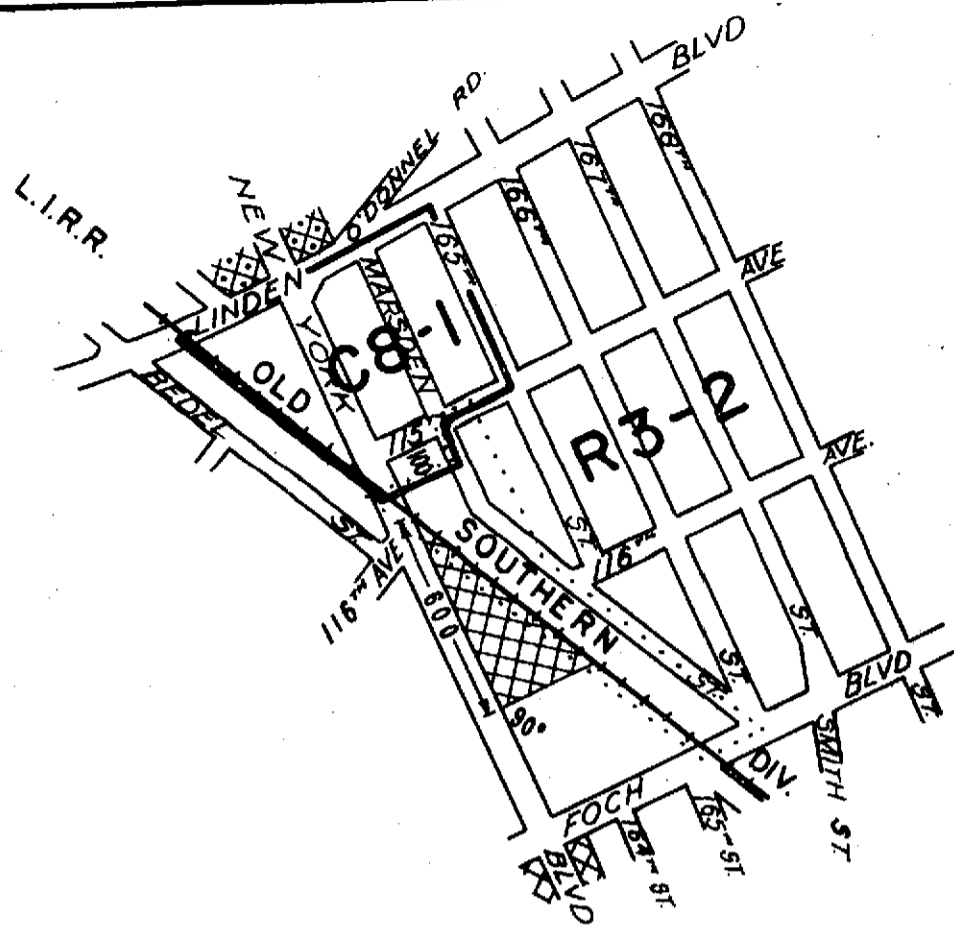

CITY PLANNING COMMISSION  
 CITY OF NEW YORK  
**DIAGRAM SHOWING PROPOSED  
 ZONING CHANGE  
 ON SECTIONAL MAP  
 18c**

BOROUGH OF  
 QUEENS



New York, November 7, 1962

*Ferdinand J. Matter*  
 Secretary

*Frank De Filippo*  
 Director, Division of Planning

*J. F. Ashworth*  
 Chief, Office of Technical Controls



- NOTE:**
- indicates Zoning District boundary.
  - ..... The area enclosed by the fine dotted line is proposed to be changed from a C8-1 District to an R3-2 District.
  -  indicates a C1-2 District.
  -  indicates a C2-2 District.

CLW F.L. RB

A 292

JAN 24, 1963



4283

C. P. 17624

OKAP

B  
FC

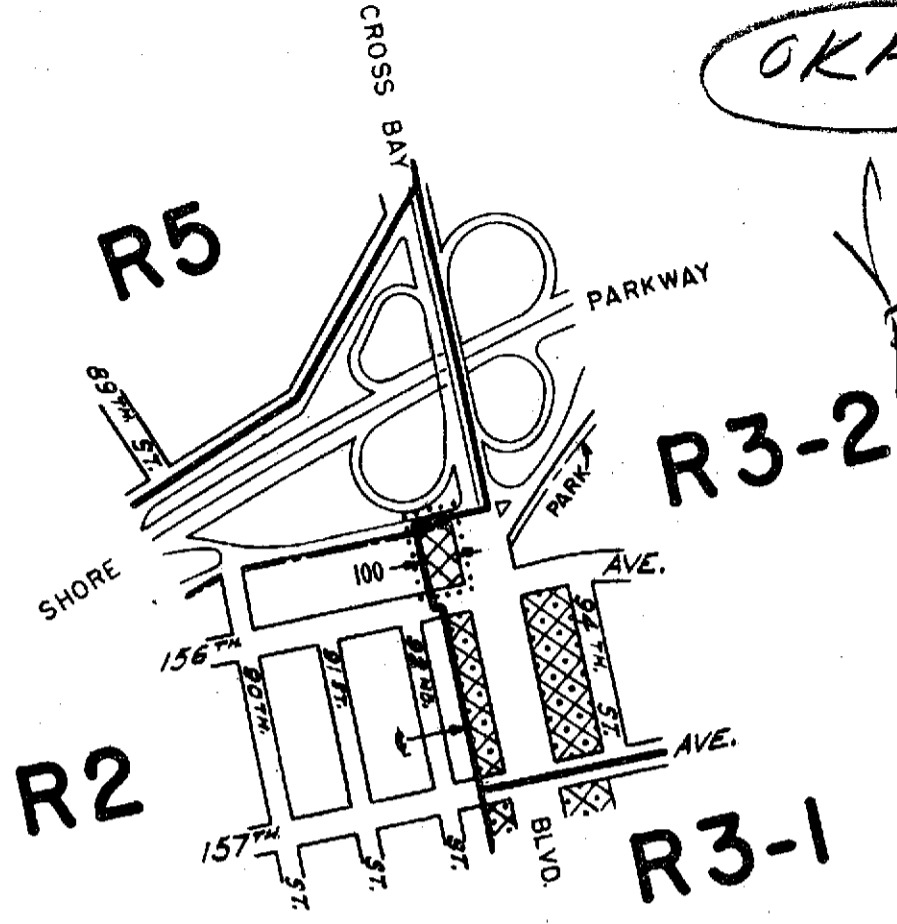

CITY PLANNING COMMISSION  
 CITY OF NEW YORK  
 DIAGRAM SHOWING PROPOSED  
 ZONING CHANGE  
 ON SECTIONAL MAP

18b ✓

BOROUGH OF  
QUEENS

New York, NOVEMBER 7, 1962

*Pauline M. Miller*  
Secretary

*Frank De Tilly*  
Director, Division of Zoning

*J. F. Ashworth*  
Chief, Office of Technical Controls



NOTE:

- indicates Zoning District boundary.
- The area enclosed by the fine dotted line is proposed to be changed by establishing a C1-2 District within an existing R3-2 District.
- indicates a C1-2 District.
- indicates a C2-2 District.

EFF DATE ✓  
DECEMBER 20 1962

A 287

C.P. 17648

OKAP

F.C.  
N.P.

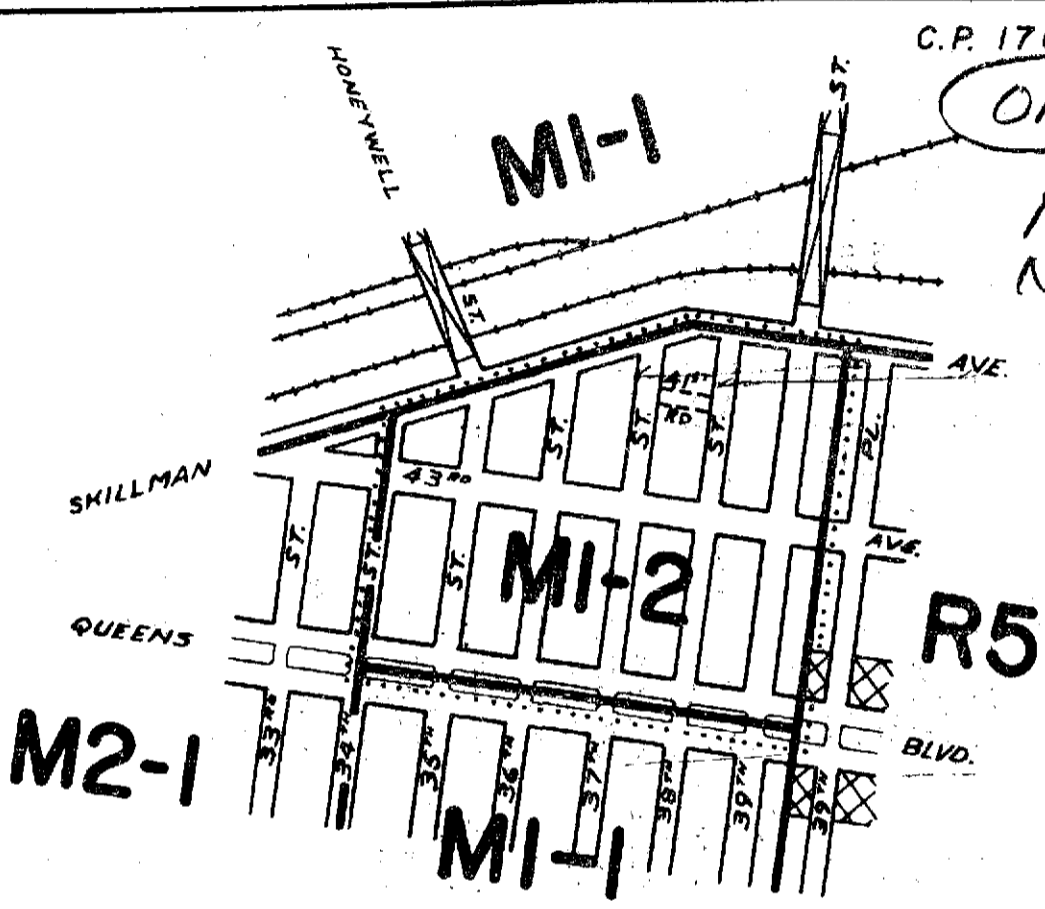

CITY PLANNING COMMISSION  
 CITY OF NEW YORK  
 DIAGRAM SHOWING PROPOSED  
 ZONING CHANGE  
 ON SECTIONAL MAP

9b

BOROUGH OF  
QUEENS

New York, November 28, 1962



*Pauline Malin*  
Secretary

*Frank De Filippo*  
Director, Division of Zoning

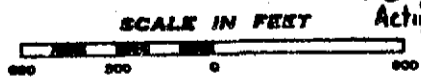
*Katherine Ginstberg*  
Acting Chief, Office of Technical Controls



NOTE:

-  indicates Zoning District boundary.
-  The area enclosed by the fine dotted line is proposed to be changed from an MI-1 District to an MI-2 District.
-  indicates a CI-2 District.

~~N.A.P. [Signature]~~

A 305

OK

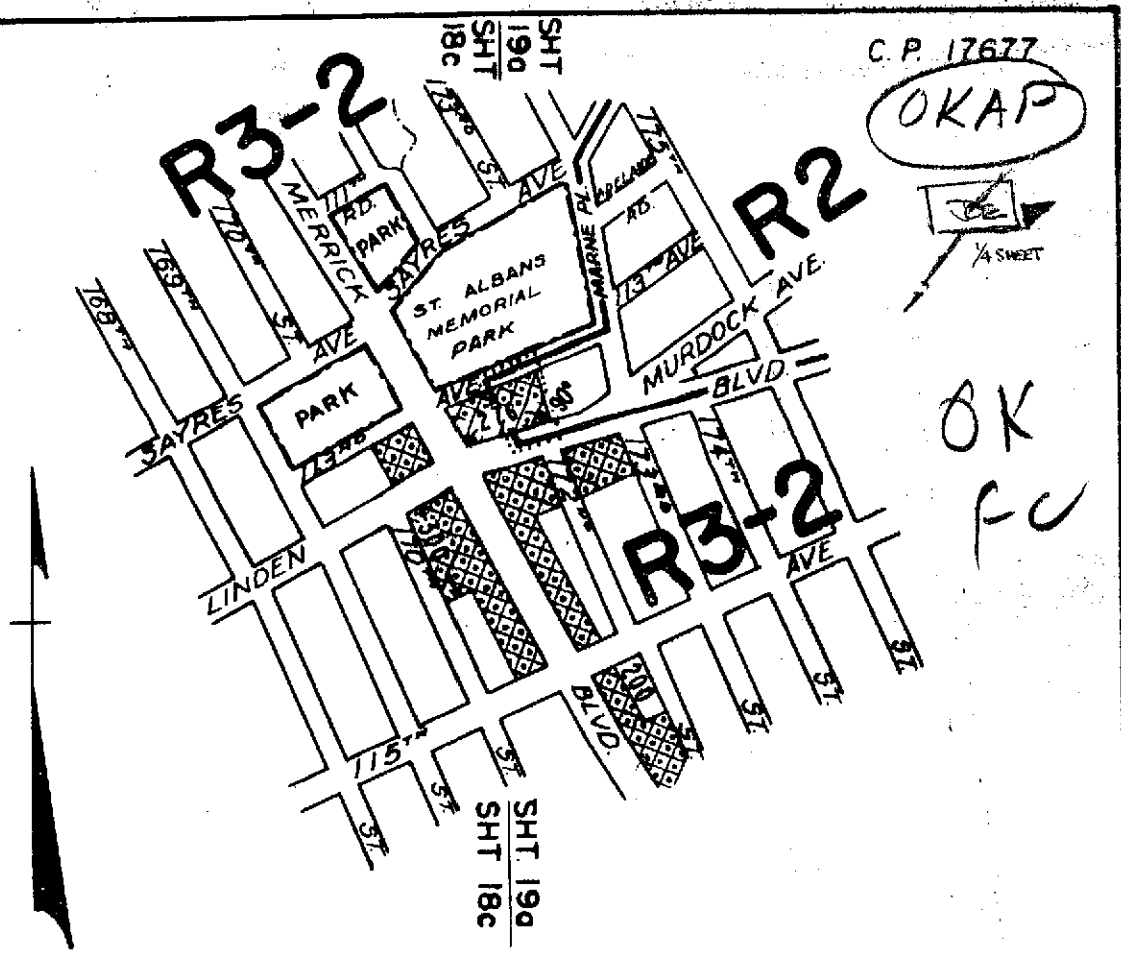

CITY PLANNING COMMISSION  
 CITY OF NEW YORK  
 DIAGRAM SHOWING PROPOSED  
 ZONING CHANGE  
 ON SECTIONAL MAP  
 18c 8 19a  
 BOROUGH OF  
 QUEENS

New York, December 12, 1962  
*Pauline Walter*  
 Secretary

*Frank De Filippo*  
 Director, Division of Zoning  
*J. F. Ashworth*  
 Chief, Office of Technical Controls



- NOTE:**
- indicates Zoning District boundary.
  - The area enclosed by the fine dotted line is proposed to be changed by the establishment of a C2-2 District within an existing R2 District.
  - indicates a C2-2 District.

CMC F.C.

eff 3/7/63

for Plate  
3/8/63

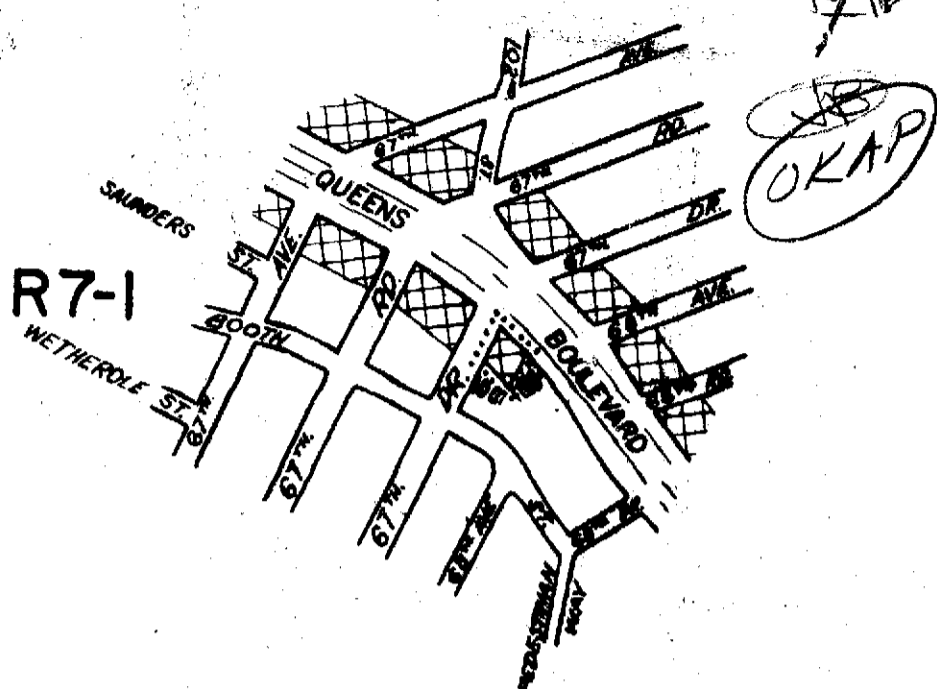

CITY PLANNING COMMISSION  
 CITY OF NEW YORK  
**DIAGRAM SHOWING PROPOSED  
 ZONING CHANGE  
 ON SECTIONAL MAP**

140  
 BOROUGH OF  
 QUEENS

*Frank De Felippis*  
 Director, Division of Zoning  
*J. F. Ashworth*  
 Chief, Office of Technical Controls

New York, January 3, 1963  
*Pauline Malin*  
 Secretary

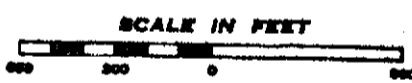

- NOTE:**
- indicates Zoning District boundary.
  - The area enclosed by the fine dotted line is proposed to be changed by the establishment of a CI-2 District within an existing R7-1 District.
  - Indicates a CI-2 District.

R.O. F.L. W 103

A299

*OK*

Feb 7/63

*FC*

R6

C.P. 17708

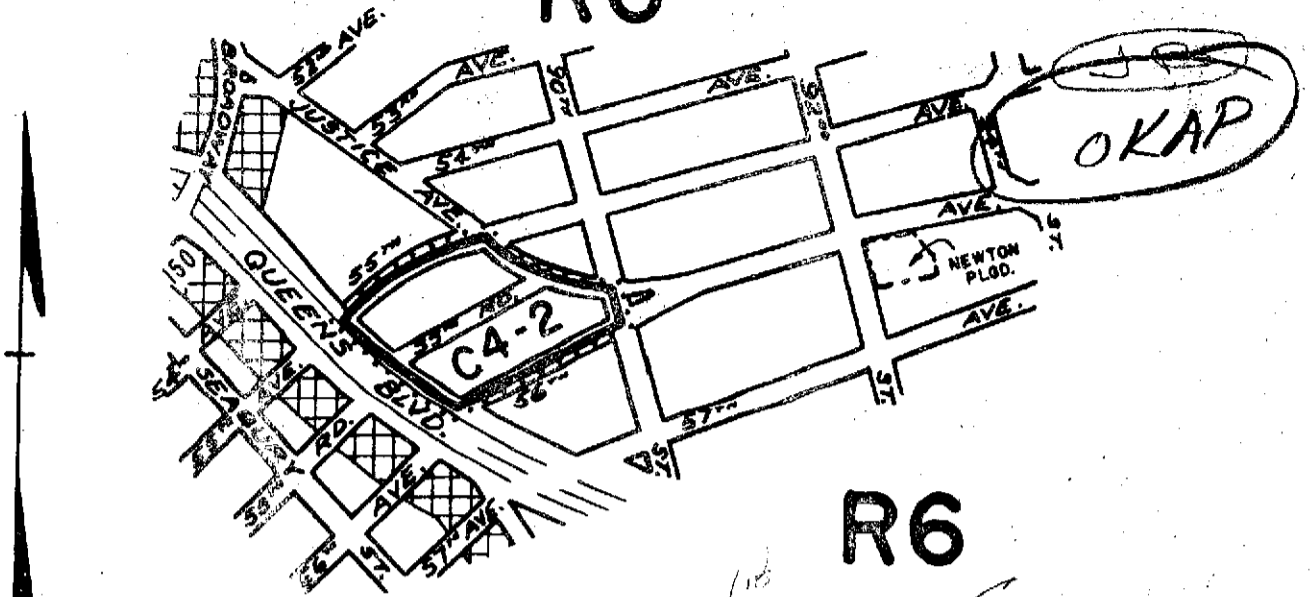

CITY PLANNING COMMISSION  
 CITY OF NEW YORK  
**DIAGRAM SHOWING PROPOSED  
 ZONING CHANGE  
 ON SECTIONAL MAP**

13c ✓  
 BOROUGH OF  
 QUEENS

New York, JANUARY 3, 1963

*Pauline J. Haller*  
 Secretary

*Frank DeFilipp*  
 Director, Division of Zoning  
*J. F. Ashworth*  
 Chief, Office of Technical Controls



**NOTE:**

- indicates Zoning District boundary.
- The area enclosed by the fine dotted line is proposed to be changed from an R6 District to a C4-2 District.
- indicate a C1-2 District.

A.P. FC ✓ JEB ✓

A 300 OK FC  
 Feb 7/63

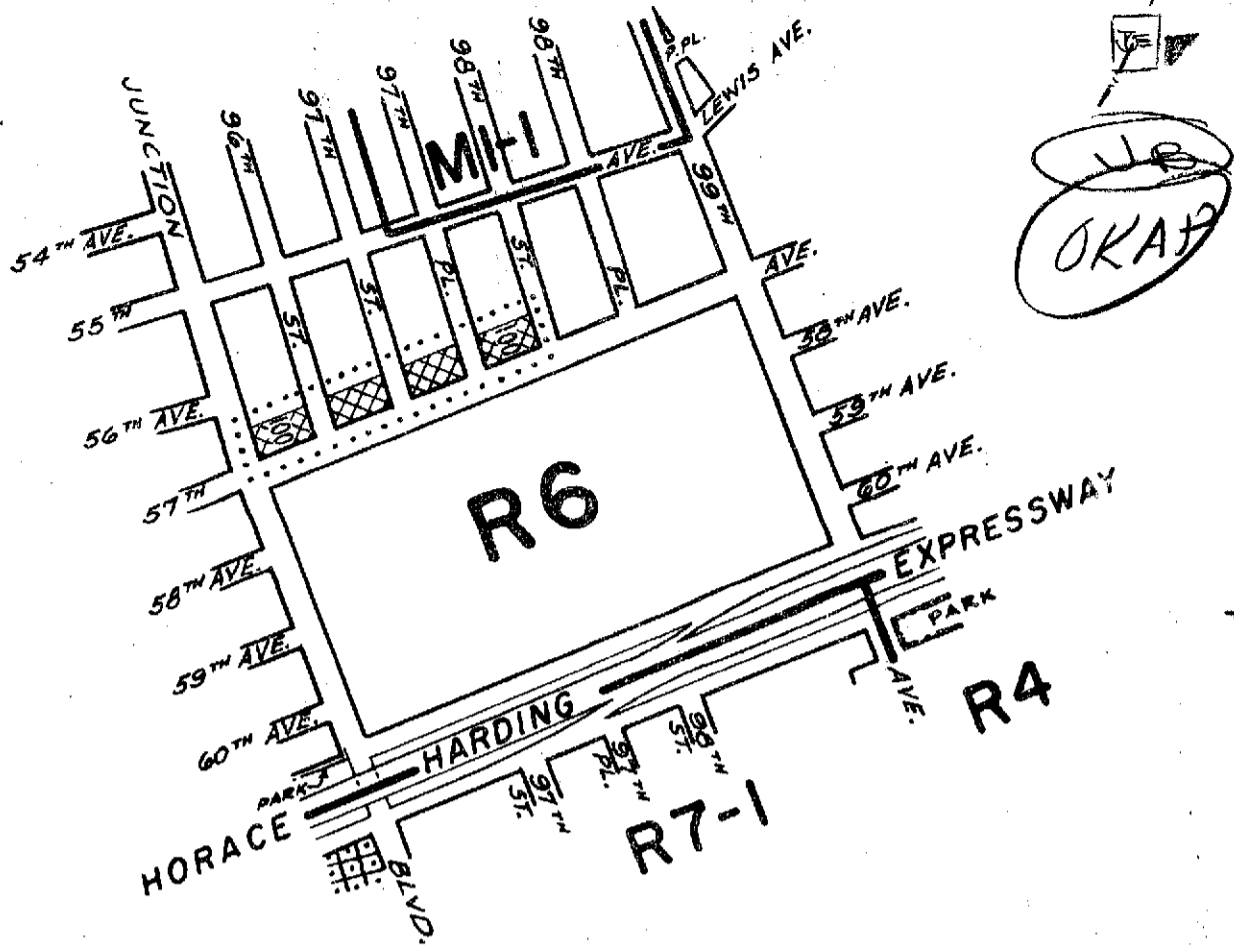

CITY PLANNING COMMISSION  
 CITY OF NEW YORK  
 DIAGRAM SHOWING PROPOSED  
 ZONING CHANGE  
 ON SECTIONAL MAP  
 14a

BOROUGH OF  
 QUEENS

New York, January 3, 1963

*Fauline Matter*  
 Secretary

*Frank De Filippo*  
 Director, Division of Zoning  
*J. F. Ashworth*  
 Chief, Office of Technical Controls



- NOTE:**
- indicates Zoning District boundary.
  - ..... The area enclosed by the fine dotted line is proposed to be changed by establishing a C1-2 District within an existing R6 District.
  - ▣ indicates a C1-2 District.
  - ▣ indicates a C2-2 District.

FC

sr

A 301

OK

Feb 7/63

A 312

C.B. 17762

OKAP

R4 VB

R4

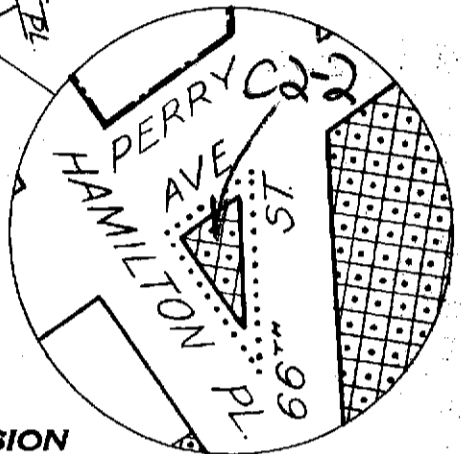
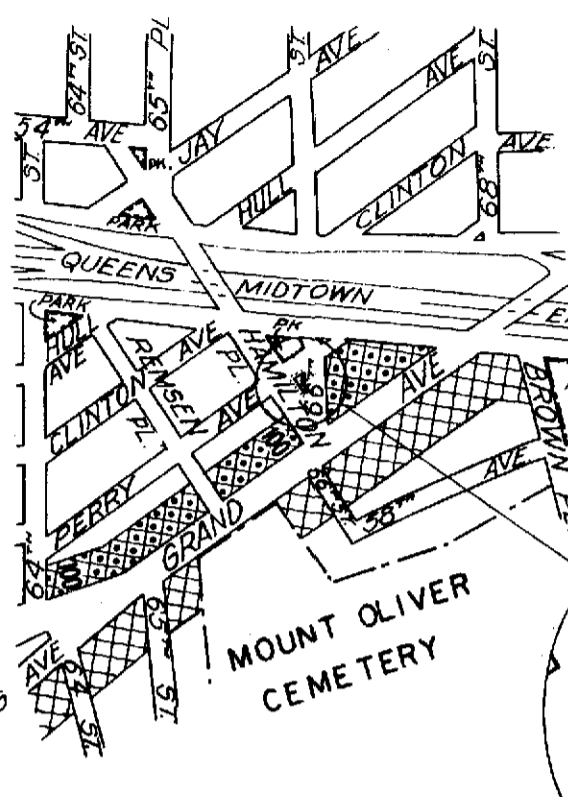

CITY PLANNING COMMISSION  
CITY OF NEW YORK  
DIAGRAM SHOWING PROPOSED  
ZONING CHANGE  
ON SECTIONAL MAP

13c

BOROUGH OF  
QUEENS

*Frank De Filippo*  
Director, Division of Zoning

*J.F. Ashworth*  
Chief, Office of Technical Controls



New York, January 30, 1963

*Benjamin Goldstein*  
Act. Secretary

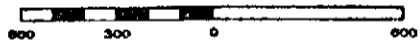
SCALE IN FEET

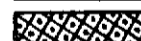

NOTE:

-  indicates Zoning District boundary.
-  The area enclosed by the fine dotted line is proposed to be changed by the establishment of a C2-2 District within an existing R4 District.
-  indicates a C1-2 District.
-  indicates a C2-2 District.

eff 4/4/63

FC

10-2-63

A 310

C.P. 17766

OKAP

VR

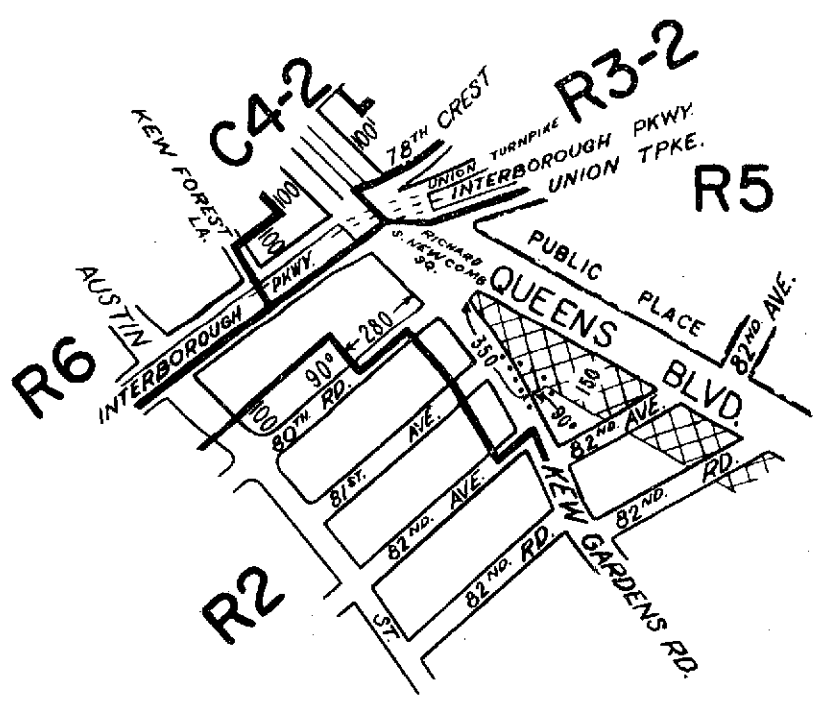

CITY PLANNING COMMISSION  
 CITY OF NEW YORK  
 DIAGRAM SHOWING PROPOSED  
 ZONING CHANGE  
 ON SECTIONAL MAP

14 b ✓

BOROUGH OF  
QUEENS

New York, January 30, 1963

*Augustine Goldstein*  
Act. Secretary

*Frank De Filippo*  
Director, Division of Zoning

*J. F. Ashworth*  
Chief, Office of Technical Controls

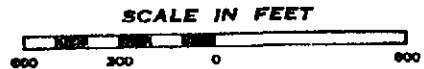

**NOTE:**

- indicates Zoning District boundary.
- The area enclosed by the fine dotted line is proposed to be changed by the establishment of a C1-2 District within an existing R5 District.
- indicates a C1-2 District.

R.C. F.C.

eff 3/7/63

VR



OKAP

Y B

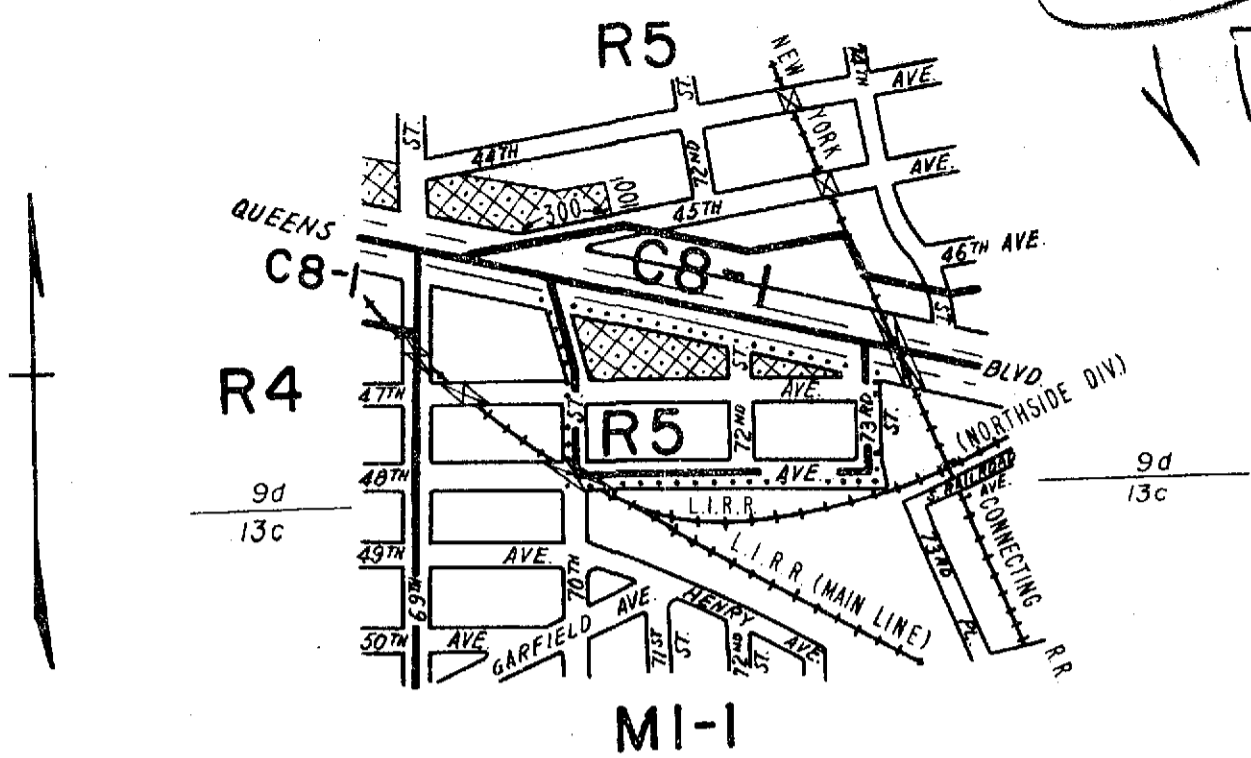

CITY PLANNING COMMISSION  
 CITY OF NEW YORK  
 DIAGRAM SHOWING PROPOSED  
 ZONING CHANGE  
 ON SECTIONAL MAP

9d ✓  
 BOROUGH OF  
 QUEENS

New York, February 27, 1963  
*Josephine Goldstein*  
 Acting Secretary

*Frank De Filippo*  
 Director, Division of Zoning  
*J. F. Ashworth*  
 Chief, Office of Technical Controls



- NOTE:**
- indicates Zoning District boundary.
  - ..... The area enclosed by the fine dotted line is proposed to be changed from an MI-1 District to an R5 District and to establish a C2-2 District within the proposed R5 District
  -  indicates a C2-2 District

A-316

FC

eff 4/4/63 RL

R3-2

OKAP

R3-1

VR

R5

R3-2

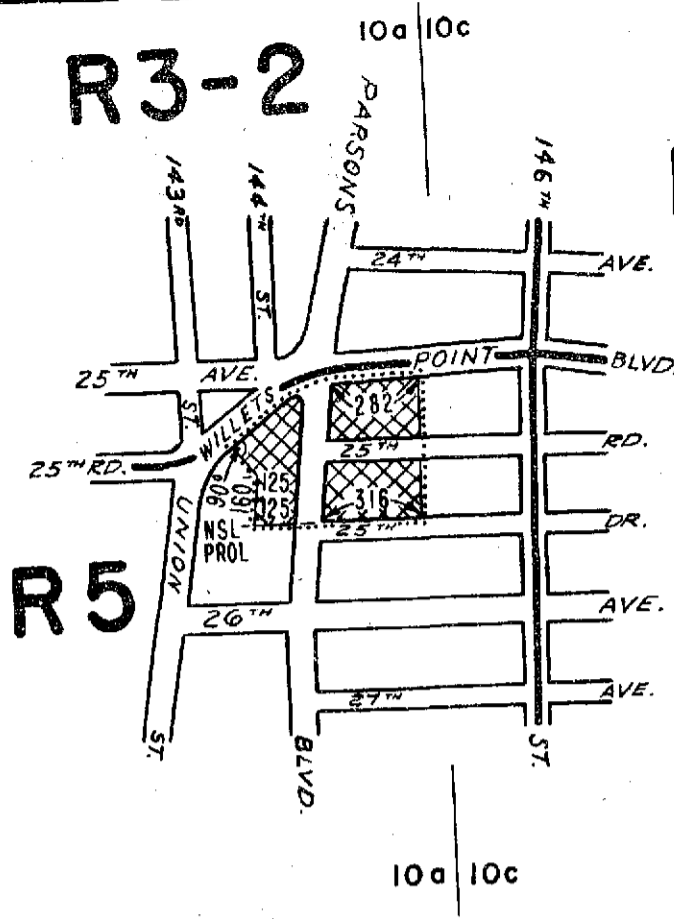

CITY PLANNING COMMISSION  
 CITY OF NEW YORK  
 DIAGRAM SHOWING PROPOSED  
 ZONING CHANGE  
 ON SECTIONAL MAP



10a ✓  
 BOROUGH OF  
 QUEENS

*Frank De Filippo*  
 Director, Division of Zoning

New York, February 27, 1963  
*Benjamin Goldstein*  
 Acting Secretary

*J. F. Ashworth*  
 Chief, Office of Technical Controls



- NOTE:**
-  indicates Zoning District boundary.
  -  The area enclosed by the fine dotted line is proposed to be changed by establishing C1-2 Districts within an existing R5 District.
  -  indicates a C1-2 District.

ST. ...

A-317

eff 4/4/63

R



Petition No. 6

C. P. 17826

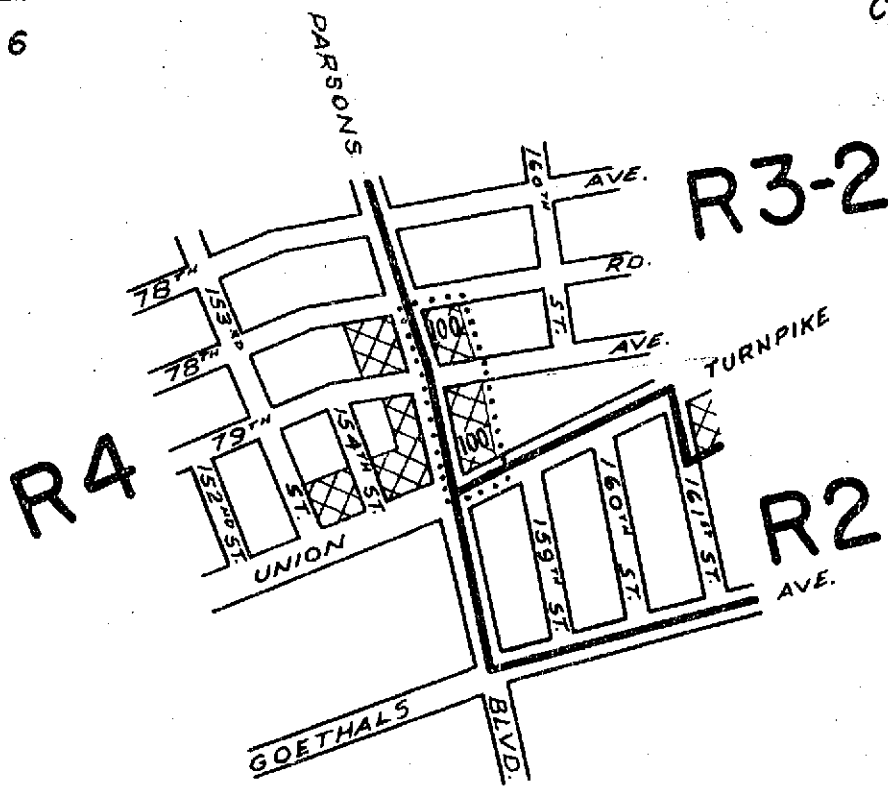
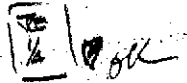

CITY PLANNING COMMISSION  
 CITY OF NEW YORK  
 DIAGRAM SHOWING PROPOSED  
 ZONING CHANGE  
 ON SECTIONAL MAP

14C  
 BOROUGH OF  
 QUEENS

*Frank De Filippo*  
 Director, Div. of Zoning

New York, March 27, 1963

*Samuel Steinberg*  
 Secretary

*J. F. Ashworth*  
 Chief, Office of Technical Controls

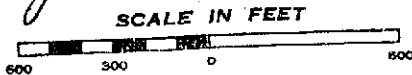

**NOTE:**

- indicates Zoning District boundary.
- The area enclosed by the fine dotted line is proposed to be changed by establishing a CI-2 District within an existing R3-2 District.
- indicates CI-2 District.

N. A. P.

June 27, 1963

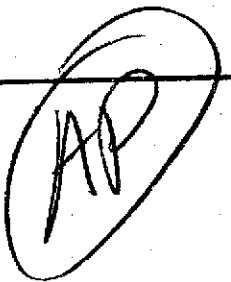

A - 341

R3-2

no dots  
Take out \*\*\* and C8-1

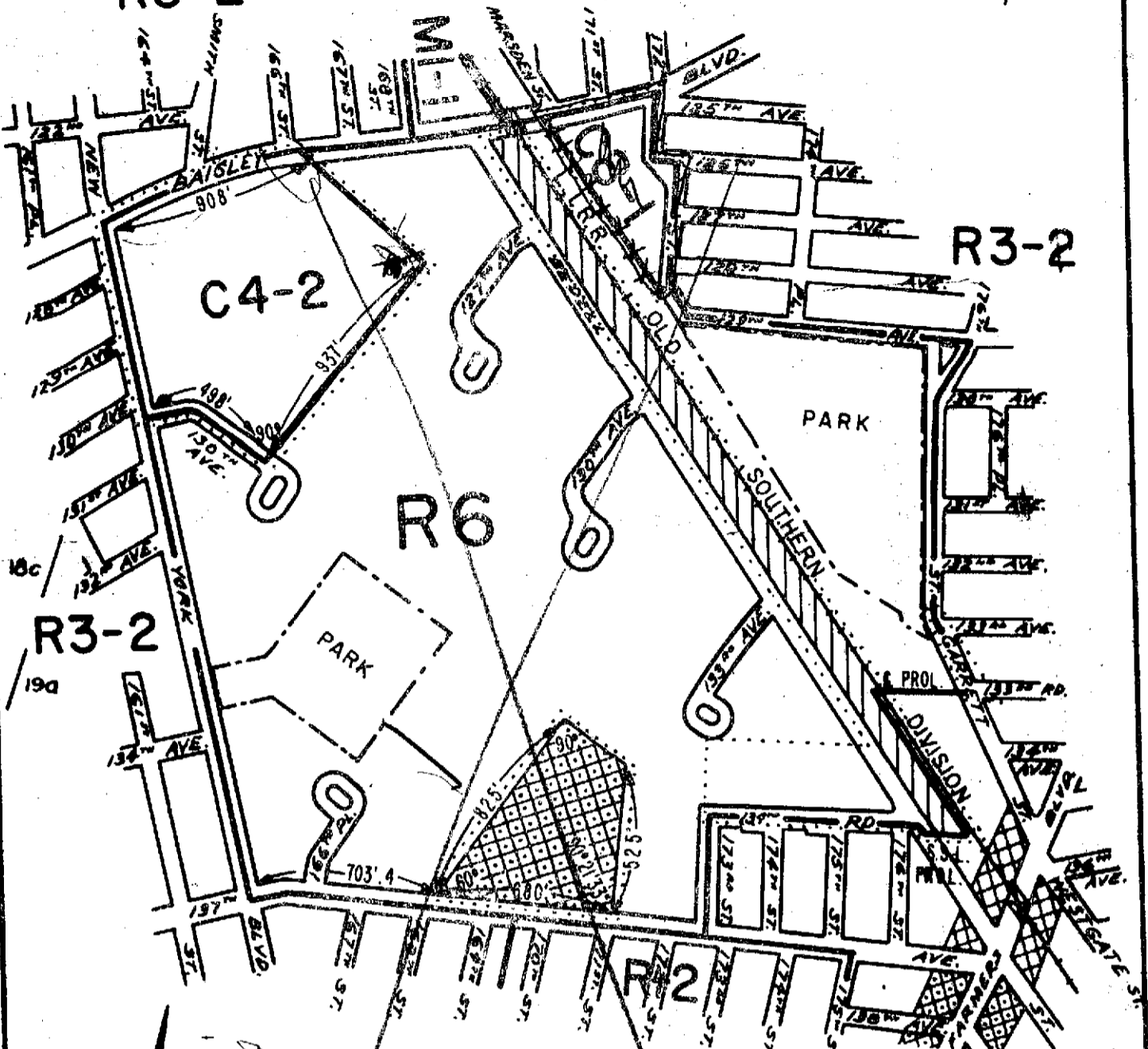

CITY PLANNING COMMISSION  
 CITY OF NEW YORK  
**DIAGRAM SHOWING PROPOSED  
 ZONING CHANGE  
 ON SECTIONAL MAP**

18c & 19a  
 BOROUGH OF  
 QUEENS

*modified*  
 New York, March 13, 1963  
*Benjamin Goldstein*  
 ACTING SECRETARY

*Louis Roberts*  
 ACT. DIRECTOR DIV. ZONING  
*J. F. Ashworth*  
 Chief, Office of Technical Controls

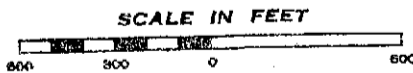

**NOTE:**

- indicates Zoning District boundary.
- The areas enclosed by the fine dotted lines are proposed to be changed from R6 and R3-2 Districts to R2, R6, C1-1, C2-2, C4-2 and C8-1 Districts.
- indicates a C1-1 District.
- indicates a C1-2 District.
- indicates a C2-2 District.

A-223

OKAP

LB

Proc

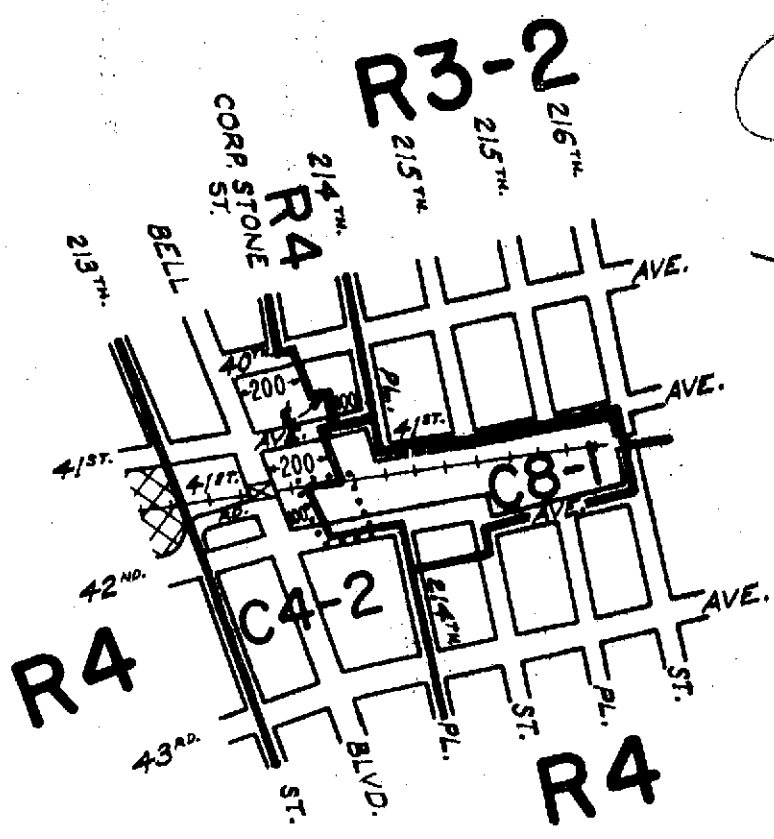

CITY PLANNING COMMISSION  
 CITY OF NEW YORK  
 DIAGRAM SHOWING PROPOSED  
 ZONING CHANGE  
 ON SECTIONAL MAP

11 a

BOROUGH OF QUEENS

New York, March 13, 1963

*Benjamin Goldstein*  
 Acting Secretary

*Louis Robert*  
 Acting Director, Division of Zoning

*J. F. Ashworth*  
 Chief, Office of Technical Controls

SCALE IN FEET



NOTE:

- indicates Zoning District boundary.
- The area enclosed by the fine dotted line is proposed to be changed from a C4-2 District to a C8-1 District.
- indicates a C1-2 District.

J.B. F.C. J

A-321

A-321

-47-

C.P. 17870



OK

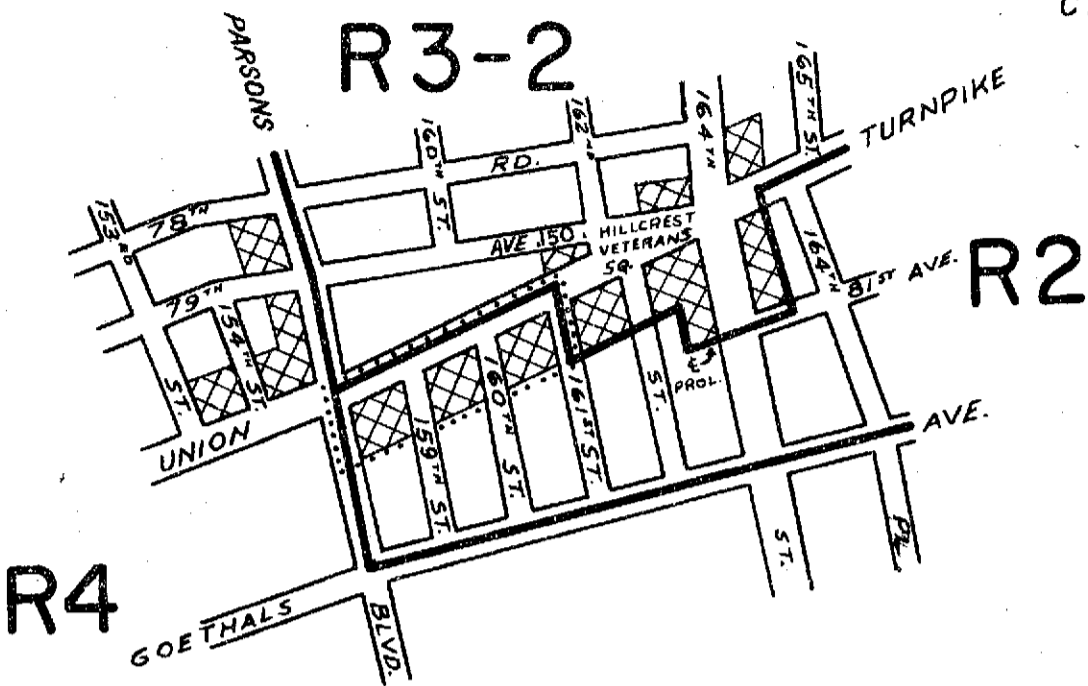

CITY PLANNING COMMISSION  
 CITY OF NEW YORK  
 DIAGRAM SHOWING PROPOSED  
 ZONING CHANGE  
 ON SECTIONAL MAP

14c  
 BOROUGH OF  
 QUEENS

New York, April 17, 1963

*Samuel Steinberg*  
 Secretary

*Frank DeFilippis*  
 Director, Div. of Zoning

*Nathan Ginsberg*  
 Acting Chief, Office of Technical Controls



- NOTE:**
- indicates Zoning District boundary.
  - The area enclosed by the fine dotted line is proposed to be changed by establishing a CI-2 District within an existing R2 District.
  - indicates CI-2 District.

N.A.P. F.C.

AP

June 27, 1963

A-342

C.P. 17903

R3-2

R3-2

R3-2

CITY PLANNING COMMISSION  
 CITY OF NEW YORK  
 DIAGRAM SHOWING PROPOSED  
 ZONING CHANGE  
 ON SECTIONAL MAP

18c

BOROUGH OF QUEENS

*Frank DeFilippis*  
 Director, Div. of Zoning



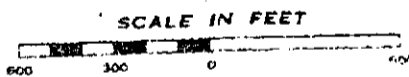

*J. F. Ashworth*  
 Chief, Office of Technical Controls

New York, April 30, 1963

Secretary



NOTE:

-  indicates Zoning District boundary.
-  The area enclosed by the fine dotted line is proposed to be changed by establishing a C1-2 District within an existing R3-2 District.
-  indicates C1-2 District.
-  Indicates C2-2 District.

N.A.P.

*F.C. VRB w*

*June 13, 63*

*A-339*

MI-1

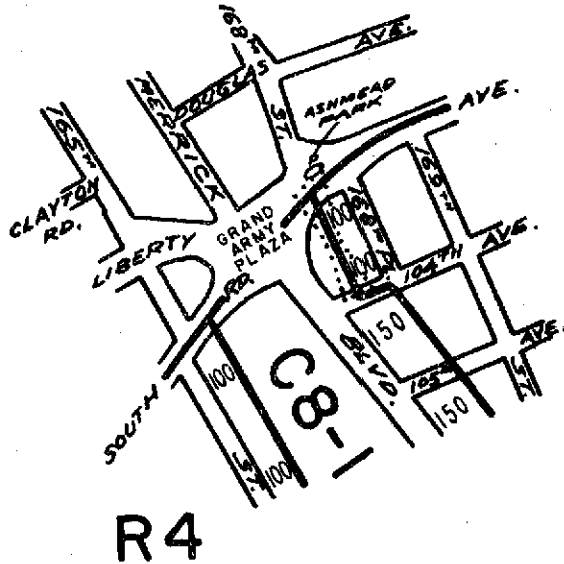

R4

R4

CITY PLANNING COMMISSION  
 CITY OF NEW YORK  
 DIAGRAM SHOWING PROPOSED  
 ZONING CHANGE  
 ON SECTIONAL MAP

14d  
 BOROUGH OF  
 QUEENS

*Frank De Filippo*  
 S.C.E.  
 Director, Division of Zoning  
*J.F. Ashworth*  
 Chief, Office of Technical Controls

New York, May 15, 1963

*Samuel Steinberg*  
 Secretary

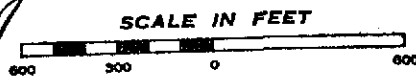

**NOTE:**

- indicates Zoning District boundary.
- .....** The area enclosed by the fine dotted line is proposed to be changed from an R4 District to a CB-1 District and from a CB-1 District to an R4 District.

*FL 118*

*AP*

*June 27, 1963*

*A-344 OK*  
*FL*



C.P. 17919

OKAP

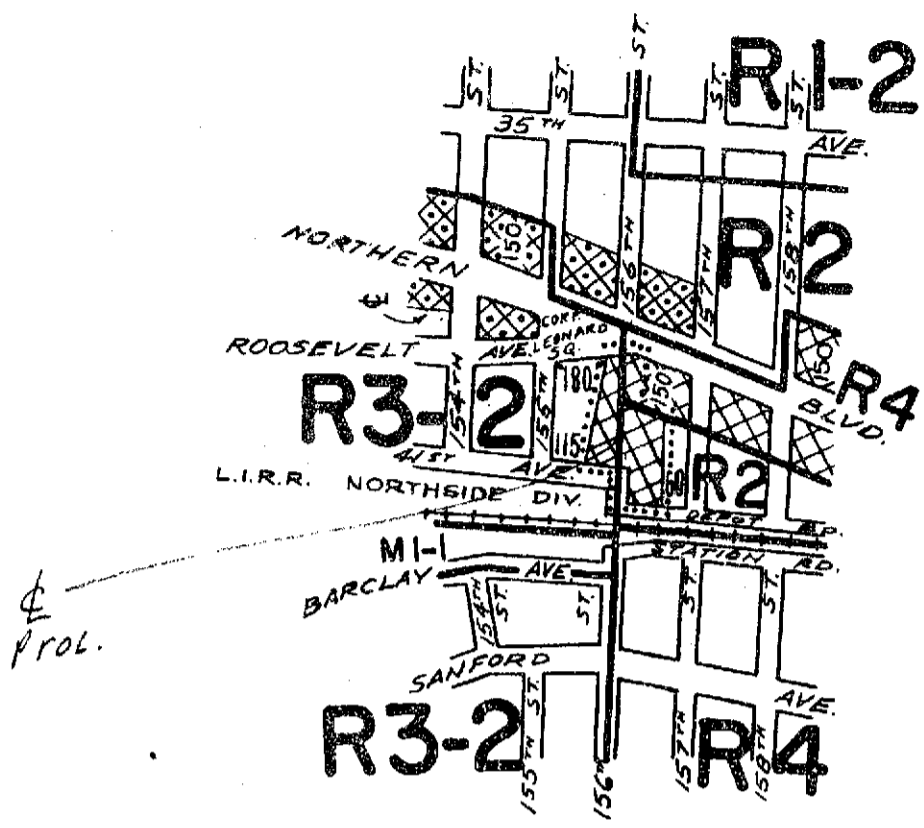

CITY PLANNING COMMISSION  
 CITY OF NEW YORK  
 DIAGRAM SHOWING PROPOSED  
 ZONING CHANGE  
 ON SECTIONAL MAP

10c

BOROUGH OF  
QUEENS

New York, July 17, 1963

*Samuel Steiner*  
 Secretary

*F. He Filippini*  
 Director, Division of Zoning

*Nathan Ginsberg*  
 Acting Chief, Office of Technical Controls

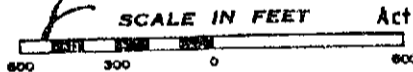

NOTE:

- indicates Zoning District boundary.
- ..... The area enclosed by the fine dotted line is proposed to be changed by establishing a C1-2 District within R2 and R3-2 Districts.



indicates a C1-2 District.



indicates a C2-2 District.

C.H.

*FC*

17919

A-369

Sept 26, 63

*FC*

*DL*

*C*

C.P. 17920

OKAP

15b  
19a

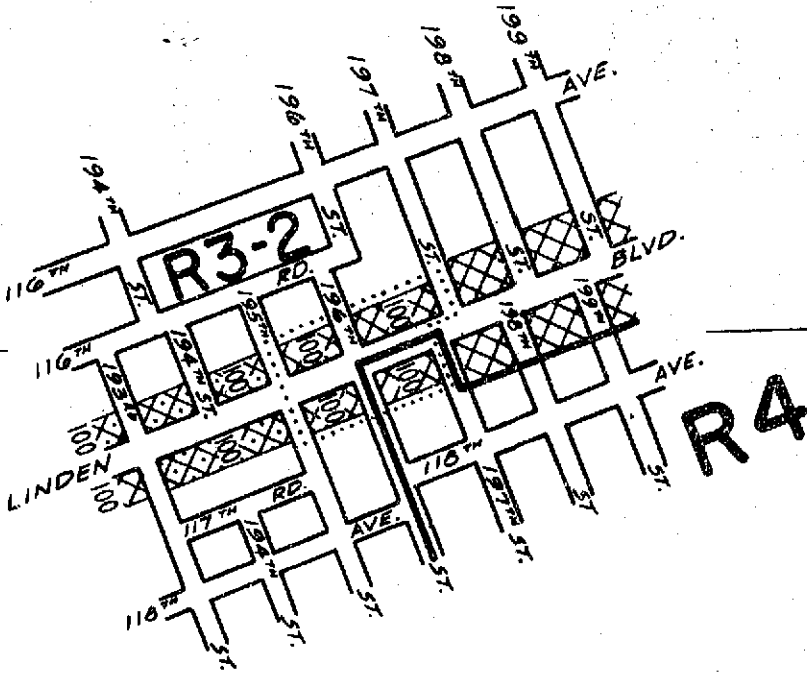

CITY PLANNING COMMISSION  
CITY OF NEW YORK  
DIAGRAM SHOWING PROPOSED  
ZONING CHANGE  
ON SECTIONAL MAPS  
15b & 19a  
BOROUGH OF  
QUEENS

New York, June 5, 1963





*Samuel Steinberg*  
Secretary

*Frank De Filippo*  
J.C.E.  
Director, Division of Zoning

*J.F. Ashworth*  
Chief, Office of Technical Controls



**NOTE:**

-  indicates Zoning District boundary.
-  The area enclosed by the fine dotted line is proposed to be changed by establishing a C1-2 District within existing R3-2 and R4 Districts.
-  Indicates a C1-2 District.
-  indicates a C2-2 District.

sr

F.C.

50b

A-352

Aug - 22, 1963

5

OKAP

VR

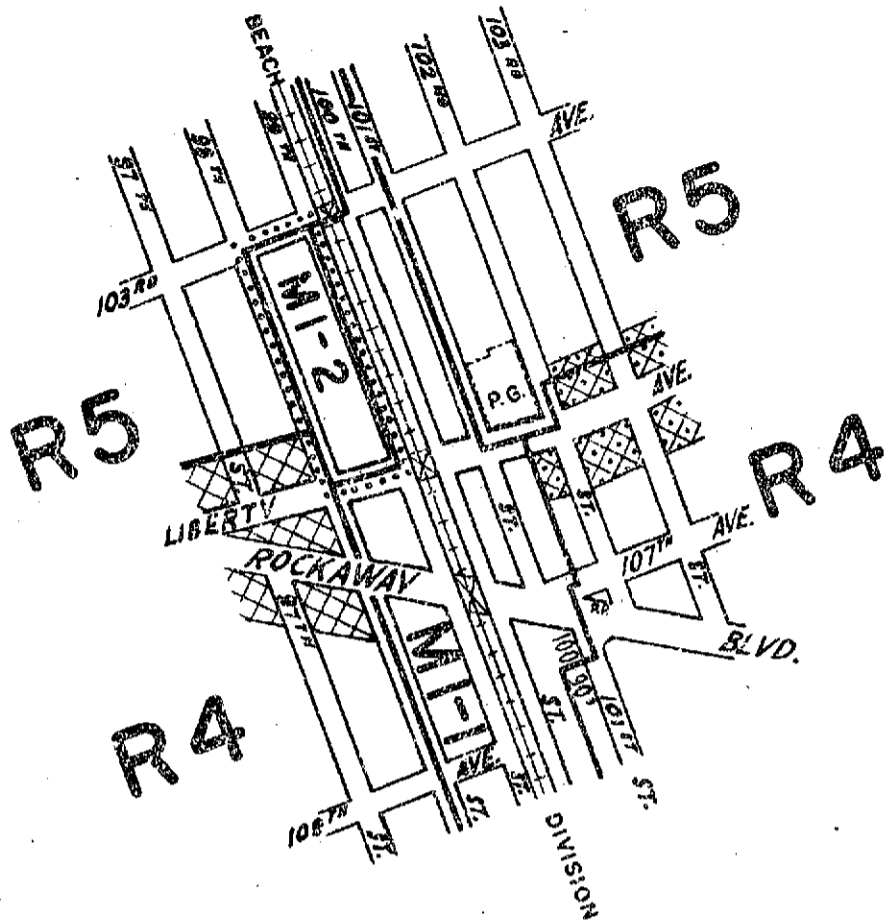

FILE

CITY PLANNING COMMISSION  
 CITY OF NEW YORK  
 DIAGRAM SHOWING PROPOSED  
 ZONING CHANGE  
 ON SECTIONAL MAP  
 18a

BOROUGH OF QUEENS

New York, June 19, 1963

*Samuel Steinberg*  
 Secretary

*F. DeFilippo*  
 S.A.C.E.  
 Director, Div. of Zoning

*J.F. Ashworth*  
 Chief, Office of Technical Controls

SCALE IN FEET

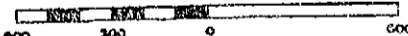

NOTE:

- indicates Zoning District boundary.
- ..... The area enclosed by the fine dotted line is proposed to be changed from an MI-1 District to an MI-2 District
- indicates a C1-2 District
- indicates a C2-2 District

*VR*

Sept 26, 63 A-360

*CR*

C.P. 17949

OKAP

NB

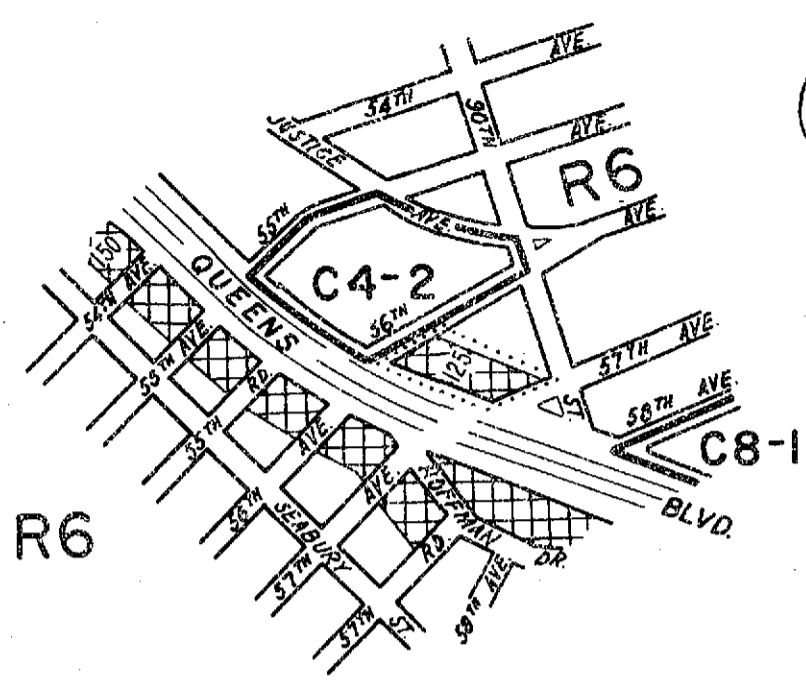

371/1

CITY PLANNING COMMISSION  
 CITY OF NEW YORK  
**DIAGRAM SHOWING PROPOSED  
 ZONING CHANGE  
 ON SECTIONAL MAP**

13c

BOROUGH OF  
QUEENS

New York, June 19, 1963

*Samuel Steinberg*  
 Secretary

*F. De Filippo*  
 Director, Div. of Zoning

*J. F. Ashworth*  
 Chief, Office of Technical Controls

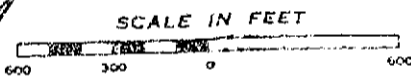

- NOTE:**
- indicates Zoning District boundary.
  - ..... The area enclosed by the fine dotted line is proposed to be changed by establishing a C1-2 District within an existing R6 District
  -  indicates a C1-2 District

13c

30 day ends  
 10/18/63  
 for A-363 to  
 A-369

A-363

Sept 26, 63

PC.

411-2

C.P. 17950

OKAP

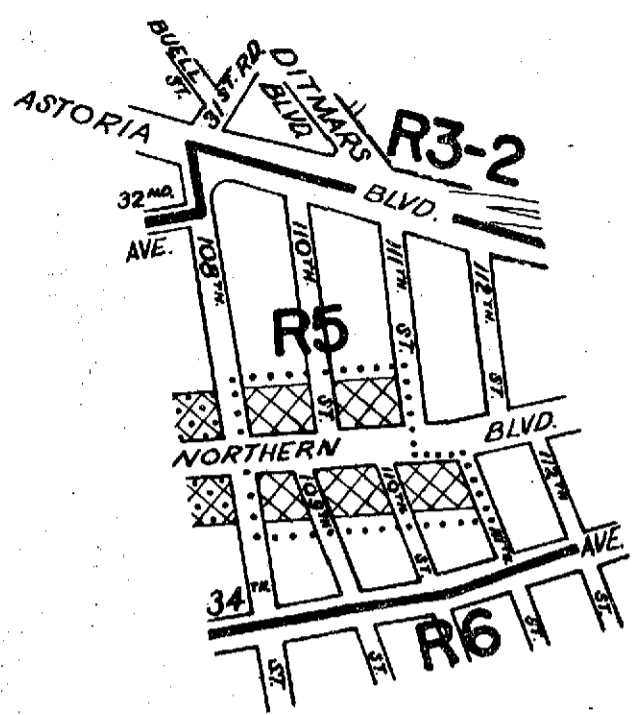

1/2 E

**CITY PLANNING COMMISSION  
CITY OF NEW YORK  
DIAGRAM SHOWING PROPOSED  
ZONING CHANGE  
ON SECTIONAL MAP  
10b ✓**

**BOROUGH OF  
QUEENS**

New York, June 19, 1963



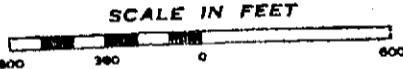

*Samuel Humberg*  
Secretary

*F. De Filippo*  
Director, Div. of Zoning

*J. F. Ashworth*  
Chief, Office of Technical Controls



**NOTE:**

-  indicates Zoning District boundary.
-  The area enclosed by the fine dotted line is proposed to be changed by establishing a C1-2 District within an existing R5 District.
-  indicates a C1-2 District.
-  indicates a C2-2 District.

R.C. FC JR W

appd 8/22/63

358

*[Handwritten signature]*

✓

OKAP

VR

1/1/63

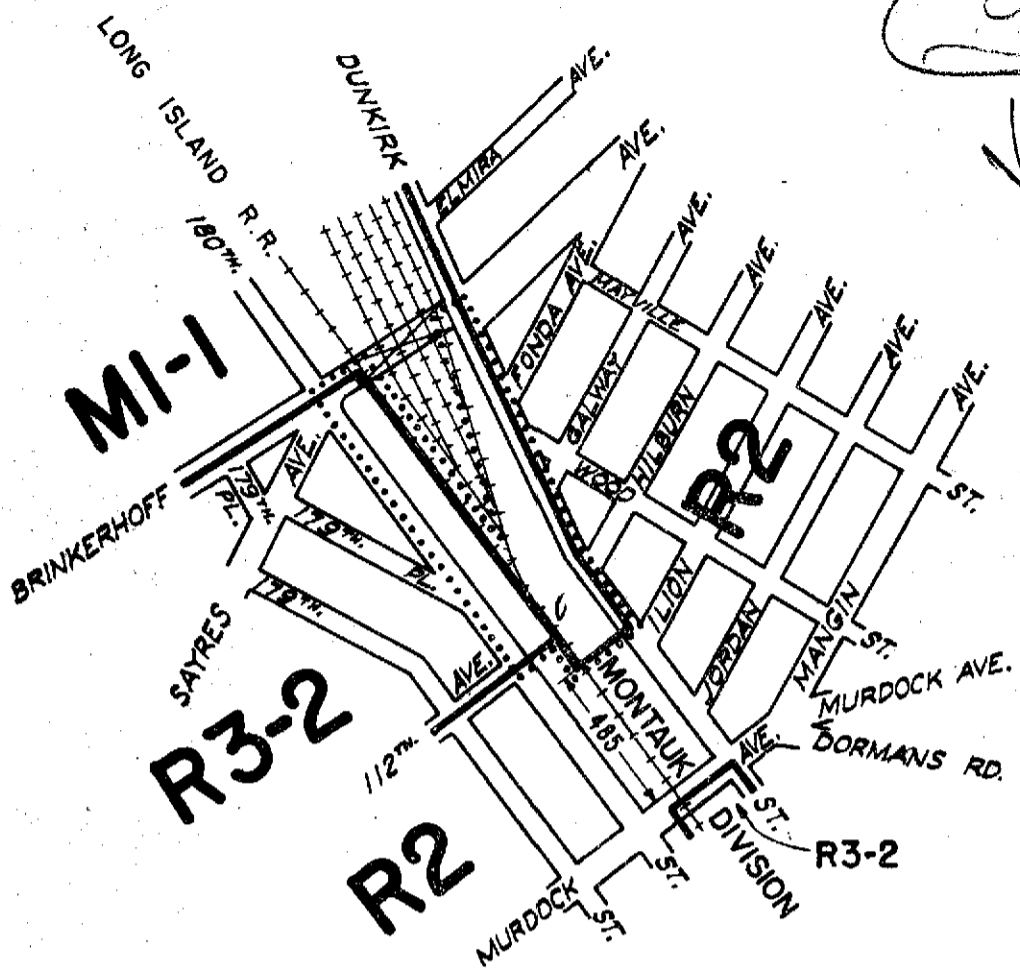

CITY PLANNING COMMISSION  
 CITY OF NEW YORK  
**DIAGRAM SHOWING PROPOSED  
 ZONING CHANGE  
 ON SECTIONAL MAP  
 15b**

BOROUGH OF QUEENS

New York, June 19, 1963

*Samuel Steinberg*  
 Secretary

*F. De Filippo*  
 Director, Div. of Zoning

*J. F. Ashworth*  
 Chief, Office of Technical Controls

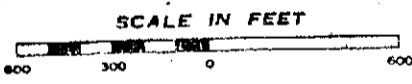

- NOTE:**
- indicates Zoning District boundary.
  - ..... The area enclosed by the fine dotted line is proposed to be changed from an R2 District to an MI-1 District and from an MI-1 District to an R3-2 District.

J.B. *F.E. RR*

A-361

Sept 26-63 R

*VR*

A-362

- 4 1/2 -

CR 17954

OKAP

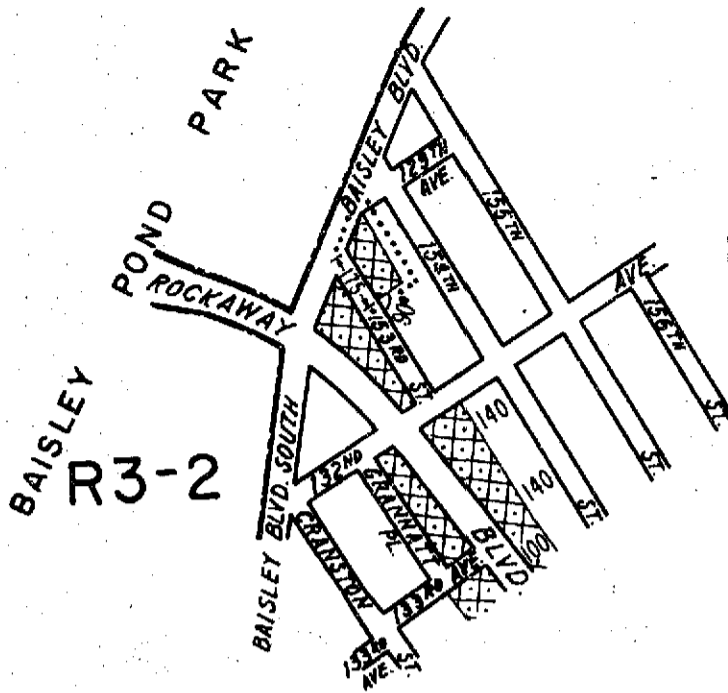

5/1/63

CITY PLANNING COMMISSION  
 CITY OF NEW YORK  
 DIAGRAM SHOWING PROPOSED  
 ZONING CHANGE  
 ON SECTIONAL MAP

18c  
 BOROUGH OF  
 QUEENS

*F. DeLuca*  
 Director, Division of Zoning



New York, June 19, 1963

*Samuel Steinberg*  
 Secretary

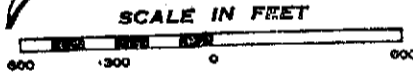
*J. F. Ashworth*  
 Chief, Office of Technical Controls



**NOTE:**

-  indicates Zoning District boundary.
-  The area enclosed by the fine dotted line is proposed to be changed by establishing a C2-2 District within an existing R3-2 District.
-  indicates a C2-2 District

A-362

Sept. 26, 63

*[Handwritten mark]*



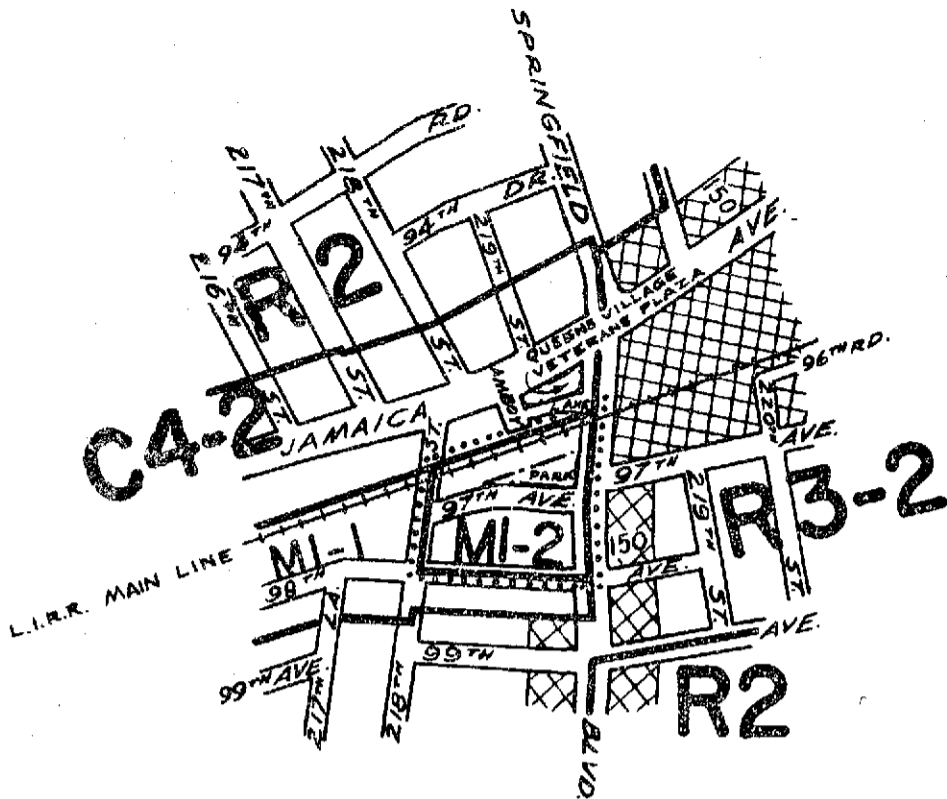
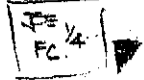

CITY PLANNING COMMISSION  
 CITY OF NEW YORK  
**DIAGRAM SHOWING PROPOSED  
 ZONING CHANGE  
 ON SECTIONAL MAP**

15 a

BOROUGH OF  
QUEENS

*F. De Tilly*  
 S.C.E.  
 Director, Division of Zoning

New York, July 17, 1963

*Edward Steubing*  
 Secretary

*Kathleen Ginstery*  
 Acting Chief, Office of Technical Controls

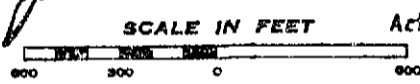

**NOTE:**

- indicates Zoning District boundary.
- The area enclosed by the fine dotted line is proposed to be changed from MI-1 and R3-2 Districts to an MI-2 District.
- indicates a C1-2 District.

S.H. FC RR.

A 377 *OK*  
 10/31/63



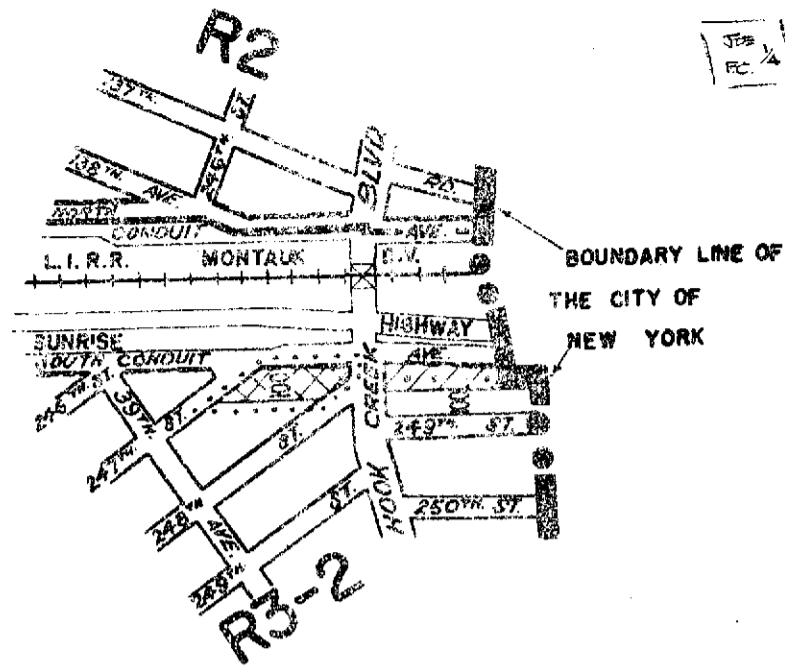
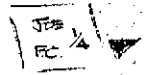

CITY PLANNING COMMISSION  
 CITY OF NEW YORK  
 DIAGRAM SHOWING PROPOSED  
 ZONING CHANGE  
 ON SECTIONAL MAP

19 d  
 BOROUGH OF  
 QUEENS

New York, July 17, 1963

*Sam Rosenberg*  
 Secretary

*F. De... S.C.E.*  
 Director, Division of Zoning

*Nathan Ginsberg*  
 Acting Chief, Office of Technical Controls

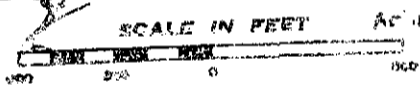

- NOTE:**
- ..... indicates Zoning District boundary.
  - ..... The area enclosed by the fine dotted line is proposed to be changed by establishing a C1-2 District within an existing R3-2 District.
  - indicates a C2-1 District.
  - indicates a C1-2 District.

R.C. F.C. KB

A 378 OR  
 10/31/63

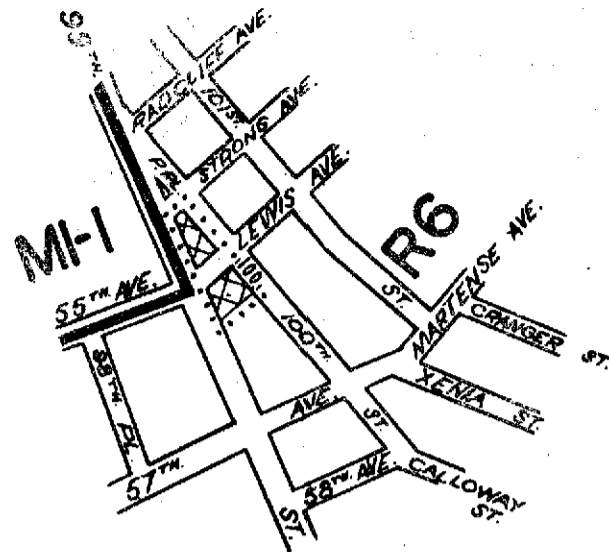

OKAP  
 NB  
 V.T.

**CITY PLANNING COMMISSION  
 CITY OF NEW YORK  
 DIAGRAM SHOWING PROPOSED  
 ZONING CHANGE  
 ON SECTIONAL MAP**

**10 b  
 BOROUGH OF  
 QUEENS**



New York, August 14, 1963

*Samuel Steinberg*  
 Secretary

*Louis Roberts*  
 Acting Director, Division of Zoning

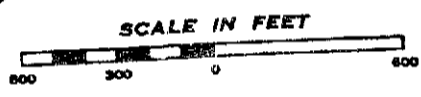
*J.F. Ashworth*  
 Chief, Office of Technical Controls



- NOTE:**
-  indicates Zoning District boundary.
  -  The area enclosed by the fine dotted line is proposed to be changed by establishing a CI-2 District within an existing R6 District.
  -  indicates a CI-2 District.

R.C. FC

A 374  
 10/17/63

OKAP



R3-2

R3-2

VB

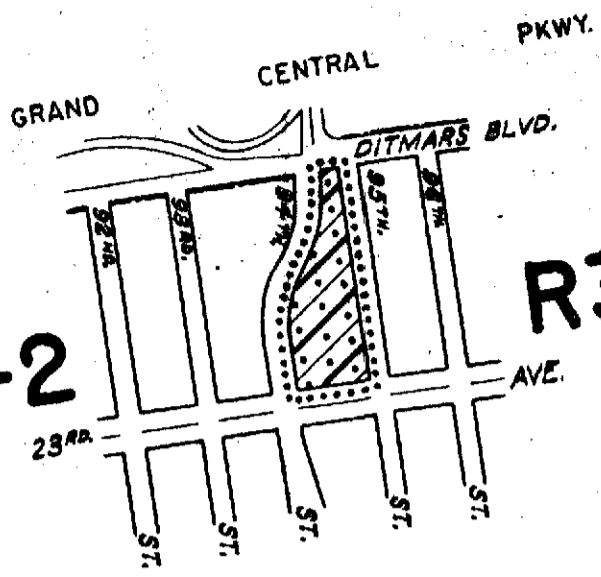

CITY PLANNING COMMISSION  
 CITY OF NEW YORK  
**DIAGRAM SHOWING PROPOSED  
 ZONING CHANGE  
 ON SECTIONAL MAP**

9c

BOROUGH OF QUEENS

New York, August 14, 1963

*Louis Roberts*  
 Acting Director, Division of Zoning

*Samuel Steinberg*  
 Secretary

*J.F. Ashworth*  
 Chief, Office of Technical Controls

SCALE IN FEET

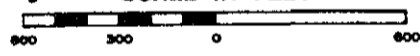

**NOTE:**

- indicates Zoning District boundary.
- The area enclosed by the fine dotted line is proposed to be changed by establishing a C2-3 District within an existing R3-2 District.
- indicates a C2-3 District.

J.B.

FC

*J*  
*U*  
*FC*

A375

10/17/63



C.P. 18047

OKAP

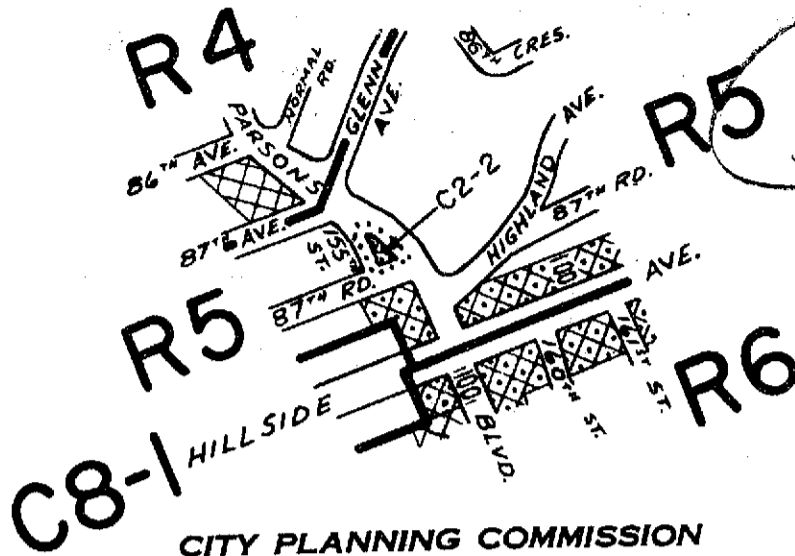

CITY PLANNING COMMISSION  
 CITY OF NEW YORK  
 DIAGRAM SHOWING PROPOSED  
 ZONING CHANGE  
 ON SECTIONAL MAP

14d  
 BOROUGH OF  
 QUEENS

*Louis Roberts*  
 Acting Director, Division of Zoning



*J.F. Ashworth*  
 Chief, Office of Technical Controls

New York, August 14, 1963

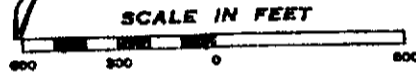
*Samuel Steinbock*  
 Secretary



NOTE:

- indicates Zoning District boundary.
- ..... The area enclosed by the fine dotted line is proposed to be changed by establishing a C2-2 District within an existing R5 District.
-  indicates a C1-2 District.
-  indicates a C2-2 District.

N.A.P. FC HC

FC

A 376

10/17/63

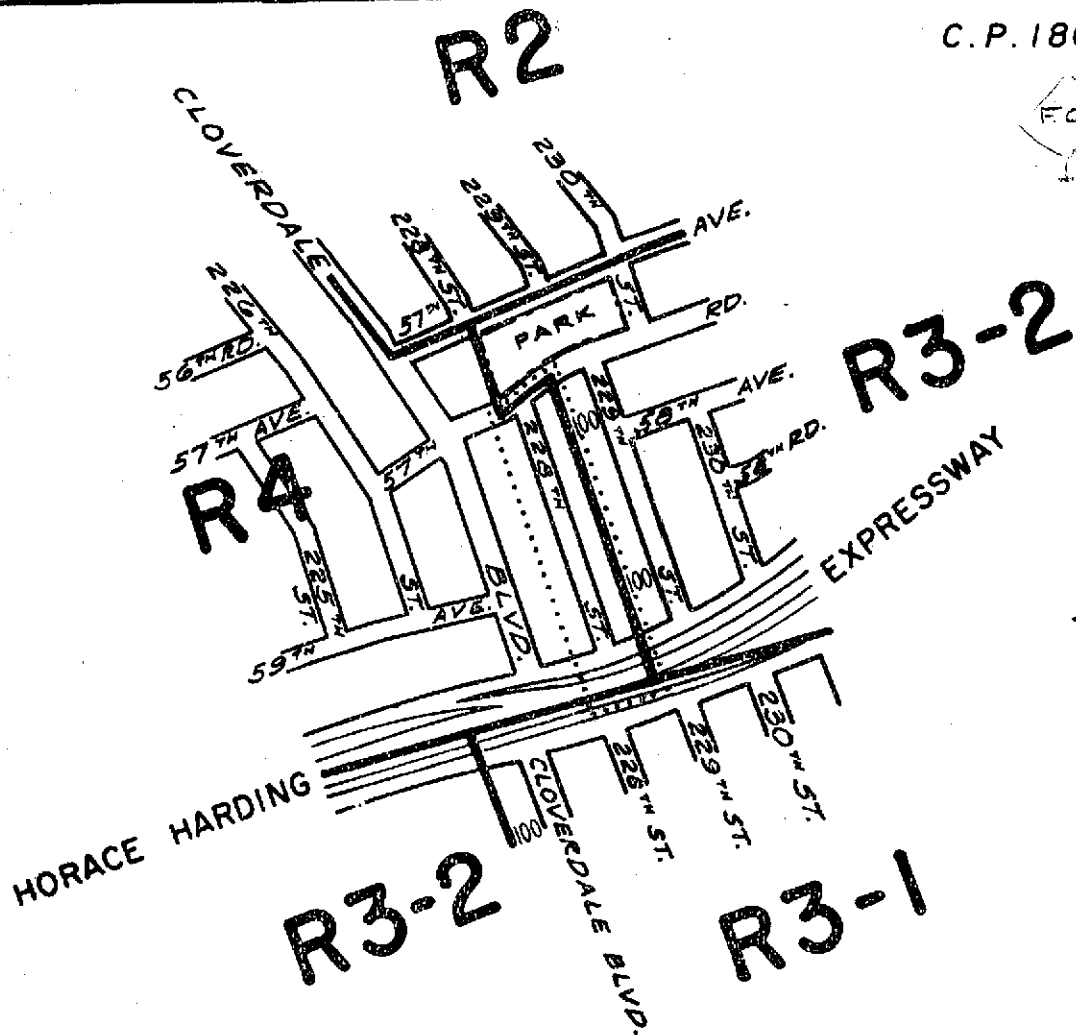

CITY PLANNING COMMISSION  
 CITY OF NEW YORK  
 DIAGRAM SHOWING PROPOSED  
 ZONING CHANGE  
 ON SECTIONAL MAP

11b

BOROUGH OF QUEENS

New York, September 4, 1963

*Samuel Stanberg*  
Secretary

*F. De Filippo*  
S.I.C.E.  
Director, Division of Zoning

*J. F. Ashworth*  
Chief, Office of Technical Controls



NOTE:

- indicates Zoning District boundary.
- ..... The area enclosed by the fine dotted line is proposed to be changed from an R3-2 District to an R4 District.

FC 51

*See Down on this  
Get later Print*

A 379  
10/31/63 *62*

JFB 1/4  
FC 1/4

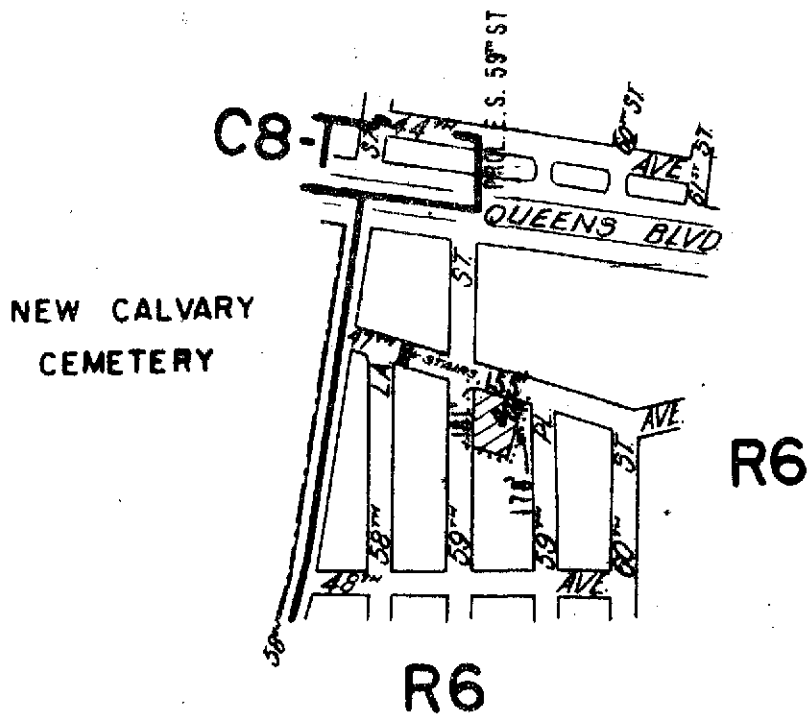

CITY PLANNING COMMISSION  
CITY OF NEW YORK  
DIAGRAM SHOWING PROPOSED  
ZONING CHANGE  
ON SECTIONAL MAP

9d  
BOROUGH OF  
QUEENS

New York, September 18, 1963

Secretary

*J. F. Ashworth*  
S.C.E.  
Director, Division of Zoning

*J. F. Ashworth*  
Chief, Office of Technical Controls

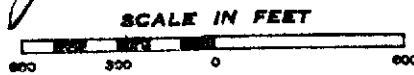

NOTE:

- indicates Zoning District boundary.
- The area enclosed by the fine dotted line is proposed to be changed by establishing a C1-1 District within an existing R6 District.
- indicates a C1-1 District.

CSM FC VP W

A382 OK WR

10/31/63

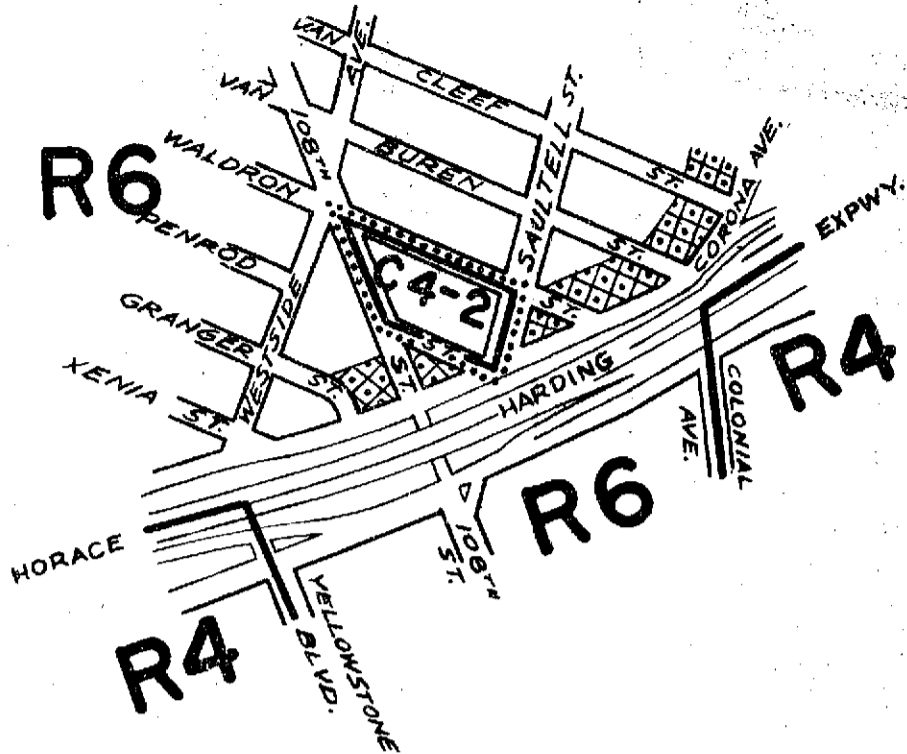

**CITY PLANNING COMMISSION  
CITY OF NEW YORK  
DIAGRAM SHOWING PROPOSED  
ZONING CHANGE  
ON SECTIONAL MAP**

**10b ✓  
BOROUGH OF  
QUEENS**

New York, September 18, 1963

*Samuel Stanbury*  
Secretary

*J. De Filippo*  
S.C.E.  
Division of Zoning

*J.F. Ashworth*  
Chief, Office of Technical Controls

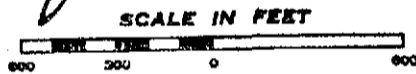

**NOTE:**

- indicates Zoning District boundary.
- The area enclosed by the fine dotted line is proposed to be changed from R6 and C1-2 Districts to a C4-2 District.
- indicates a C2-2 District.

C.H.

*FC*

*A383* *OK*

*10/31/63*

JOE  
P.C.  
1/4

# R3-2

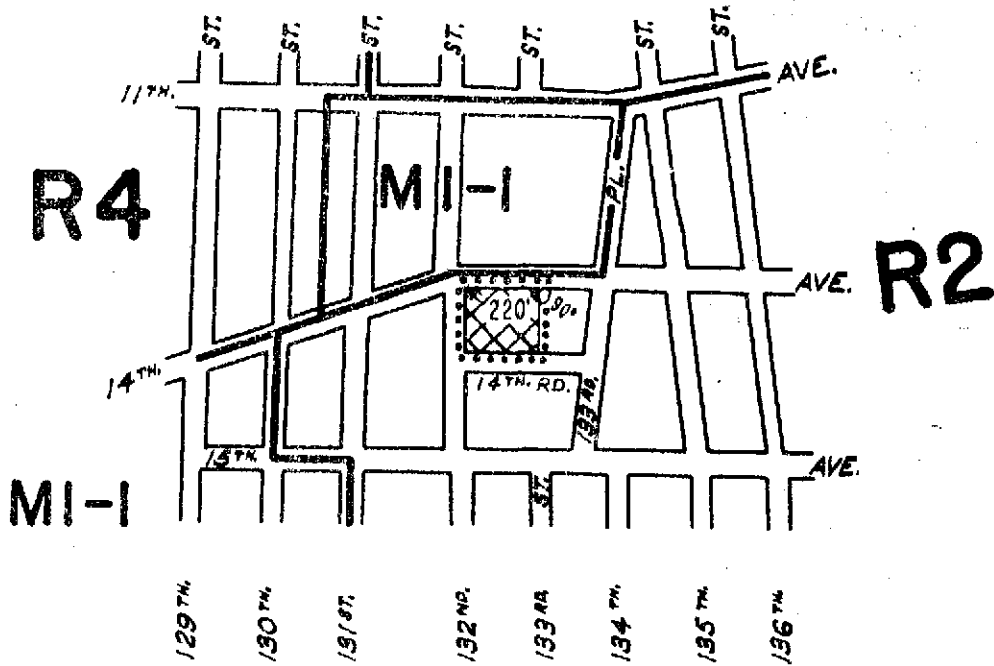

CITY PLANNING COMMISSION  
CITY OF NEW YORK  
**DIAGRAM SHOWING PROPOSED  
ZONING CHANGE  
ON SECTIONAL MAP**

7b ✓

BOROUGH OF  
QUEENS

New York, September 18, 1963

*Samuel Steinberg*  
Secretary

*F. De Zilpp*  
S.C.E.  
Director, Division of Zoning

*J.F. Ashworth*  
Chief, Office of Technical Controls

SCALE IN FEET

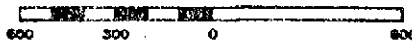

**NOTE:**

- indicates Zoning District boundary.
- .....** The area enclosed by the fine dotted line is proposed to be changed by establishing a CI-2 District within an existing R2 District.
- XXXXXX** indicates a CI-2 District.

J.B. P.C. ✓ RB ✓

A 384 or  
10/31/63



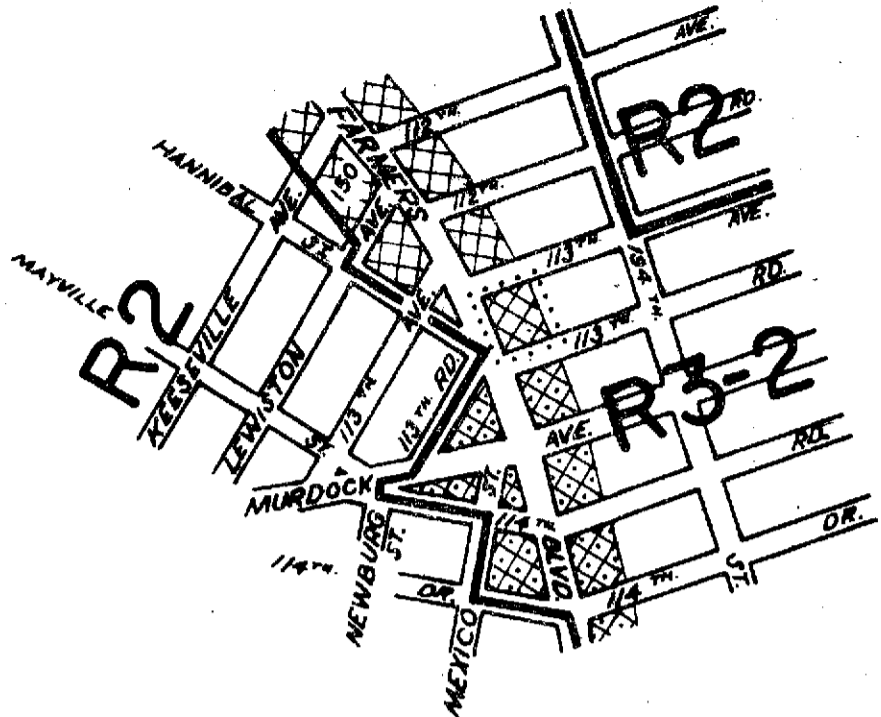

CITY PLANNING COMMISSION  
 CITY OF NEW YORK  
**DIAGRAM SHOWING PROPOSED  
 ZONING CHANGE  
 ON SECTIONAL MAP**

15 b

BOROUGH OF  
QUEENS

*J. F. Ashworth*  
 S.I.C.E.  
 Director, Div. of Zoning



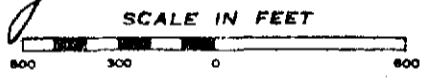

*J. F. Ashworth*  
 Chief, Office of Technical Controls

New York, September 18, 1963

*Samuel Starobin*  
 Secretary



**NOTE:**

-  indicates Zoning District boundary.
-  The area enclosed by the fine dotted line is proposed to be changed by establishing a C1-2 District within an existing R3-2 District.
-  Indicates a C1-2 District.
-  indicates a C2-2 District.

R.C. F.C. ✓ RB ✓

A-396 ✓  
 F.C.  
 ✓

12/19/63

3

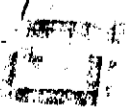

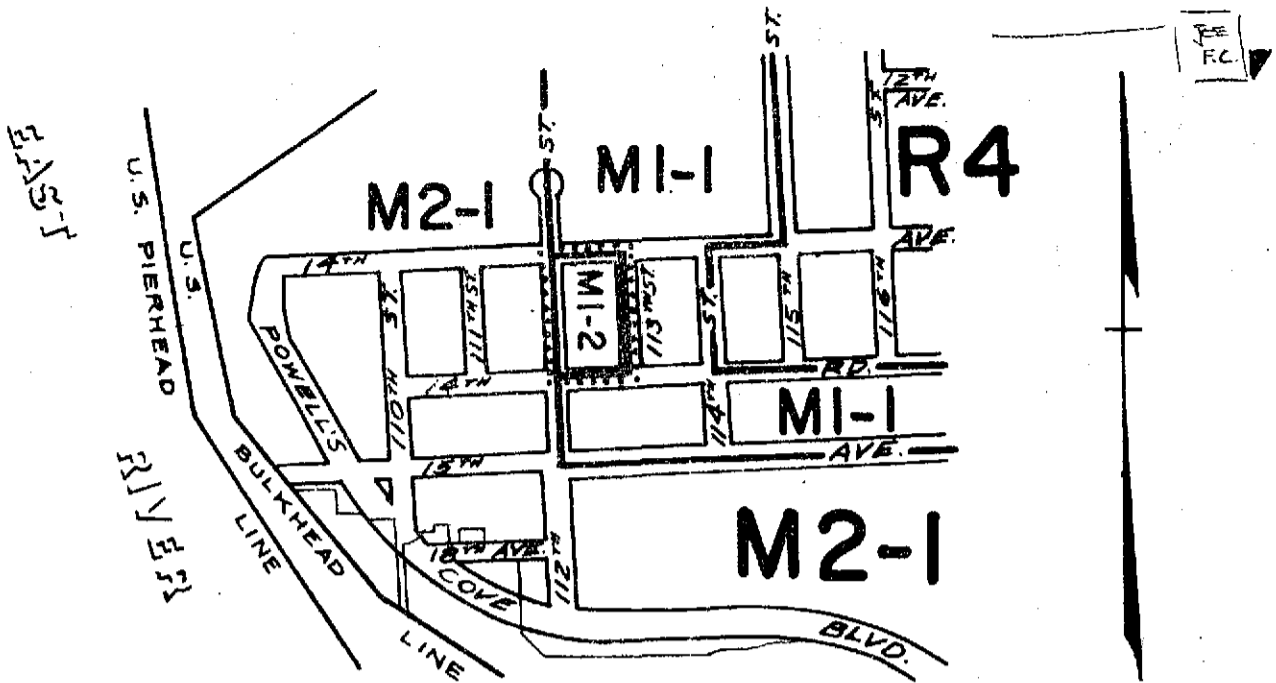

CITY PLANNING COMMISSION  
 CITY OF NEW YORK  
**DIAGRAM SHOWING PROPOSED  
 ZONING CHANGE  
 ON SECTIONAL MAP  
 7b**

BOROUGH OF  
 QUEENS

New York, September 18, 1963

*Samuel Steinberg*  
 Secretary

*The Mayor*  
 S.A.C.E.  
 Director, Division of Zoning

*J. F. Ashworth*  
 Chief, Office of Technical Controls



- NOTE:**
- indicates Zoning District boundary.
  - ..... The area enclosed by the fine dotted line is proposed to be changed from an MI-1 District to an MI-2 District.

A 385 OK  
 10/31/63

C.H. W

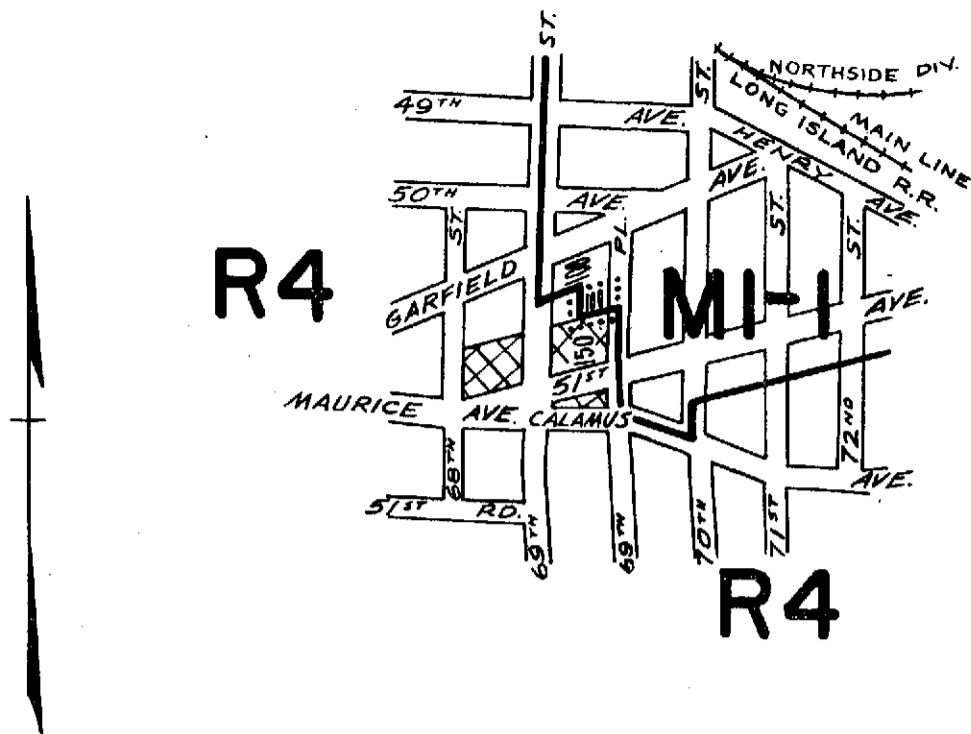

CITY PLANNING COMMISSION  
CITY OF NEW YORK  
DIAGRAM SHOWING PROPOSED  
ZONING CHANGE  
ON SECTIONAL MAP

13c  
BOROUGH OF  
QUEENS

New York, October 9, 1963



*Samuel Stenberg*  
Secretary

*F. De Filippo*  
S.C.E.  
Director, Division of Zoning

*J. F. Ashworth*  
Chief, Office of Technical Controls



NOTE:

-  indicates Zoning District boundary.
-  The area enclosed by the fine dotted line is proposed to be changed from an R4 District to an MI-1 District.
-  indicates a C1-2 District.

G.H. FC JRB

A-404  
EFF. January 9, 1964

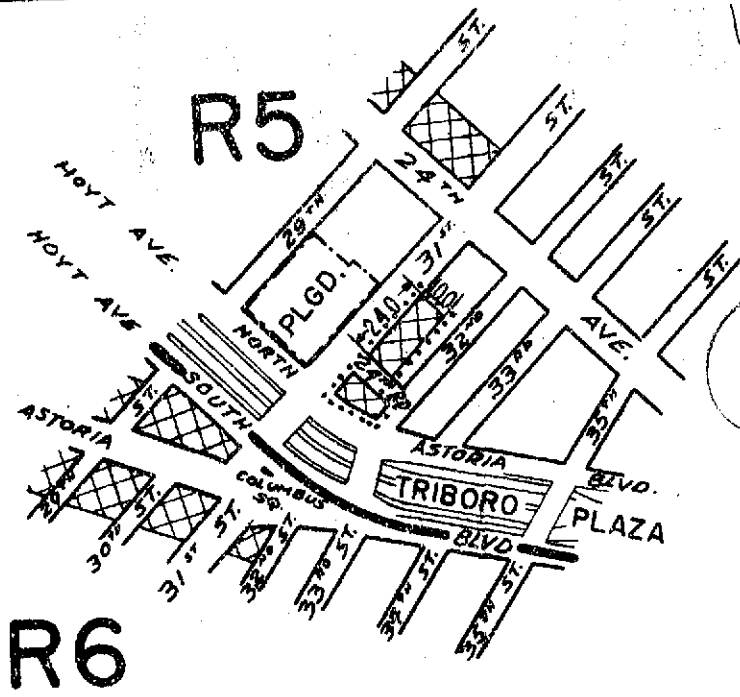

*OKAP*  
**R5**  
*[Handwritten signature]*

**CITY PLANNING COMMISSION  
CITY OF NEW YORK  
DIAGRAM SHOWING PROPOSED  
ZONING CHANGE  
ON SECTIONAL MAP**

**90  
BOROUGH OF  
QUEENS**

New York, November 13, 1963

*Samuel Steinberg*  
Secretary

*[Handwritten signature]*  
Director, Division of Zoning

*J. F. Ashworth*  
Chief, Office of Technical Controls

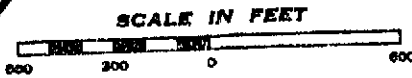

**NOTE:**

- indicates Zoning District boundary.
- The area enclosed by the fine dotted line is proposed to be changed by establishing a Cl-2 District within an existing R5 District.
- indicates a Cl-2 District

N.A.P. *FC*

*106*

*A-409 ✓*

*January 23, 1964*



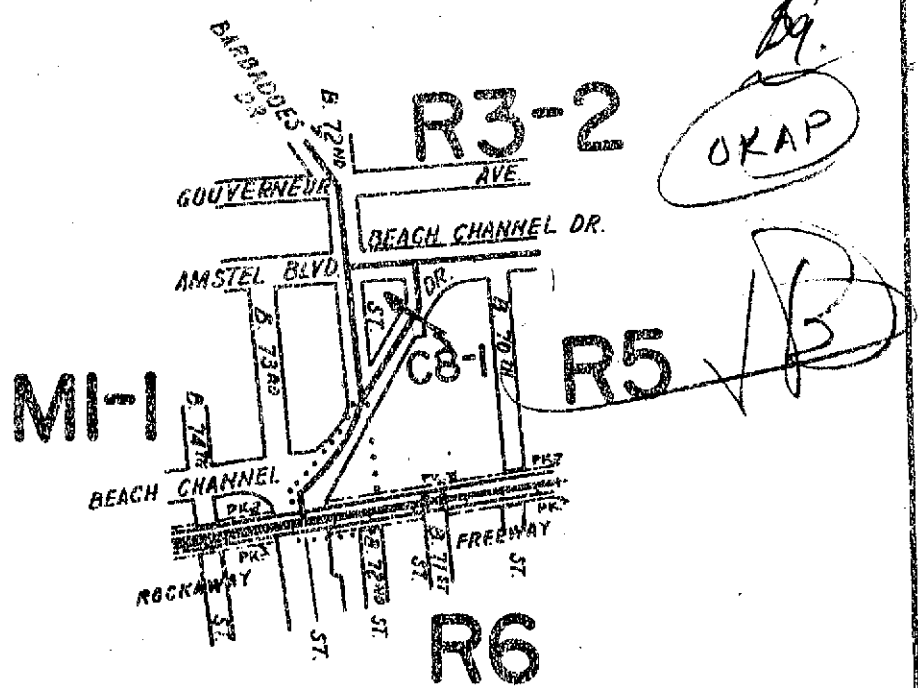

CITY PLANNING COMMISSION  
 CITY OF NEW YORK  
 DIAGRAM SHOWING PROPOSED  
 ZONING CHANGE  
 ON SECTIONAL MAP

30c  
 BOROUGH OF  
 QUEENS

New York, November 13, 1963

*Samuel Steinberg*  
 Secretary

*F. DeWitt*  
 S.C.E.  
 Director, Division of Zoning

*J. F. Ashworth*  
 Chief, Office of Technical Controls

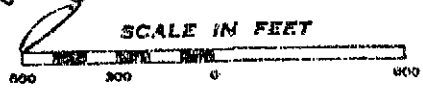

- NOTE:**
- \_\_\_\_\_ indicates Zoning District boundary.
  - ..... The area enclosed by the fine dotted line is proposed to be changed from an MI-1 District to an R5 District.

JOE

*F.C. - RR W*

*A-406*

*January 23, 1969*



C.P. 182150

R3-2

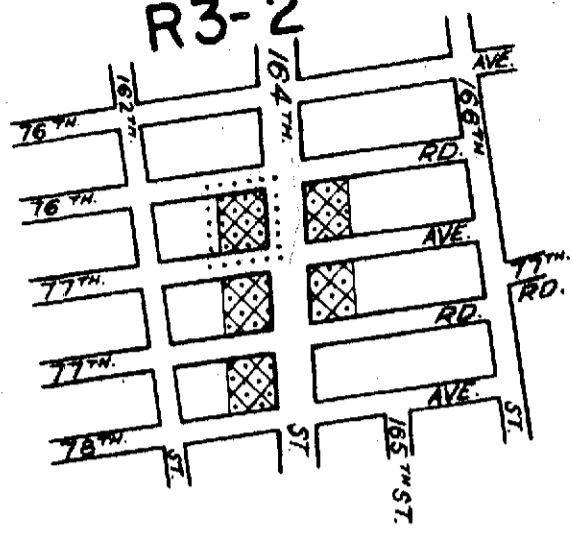

CITY PLANNING COMMISSION  
CITY OF NEW YORK  
DIAGRAM SHOWING PROPOSED  
ZONING CHANGE  
ON SECTIONAL MAP  
14c

BOROUGH OF  
QUEENS

New York, January 2, 1964

*Samuel Steinberg*  
Secretary

*J. F. Ashworth*  
Director, Division of Zoning  
*J. F. Ashworth*  
Chief, Office of Technical Controls

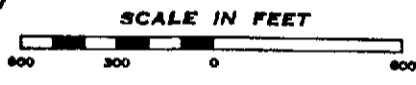

NOTE:

- indicates Zoning District boundary.
- ..... The area enclosed by the fine dotted line is proposed to be changed by establishing a C2-2 District within an existing R3-2 District.
- indicates a C2-2 District.

RC

FC / HC ✓

OKAP

A-416

Feb 20 64

OK

C.P. 18216

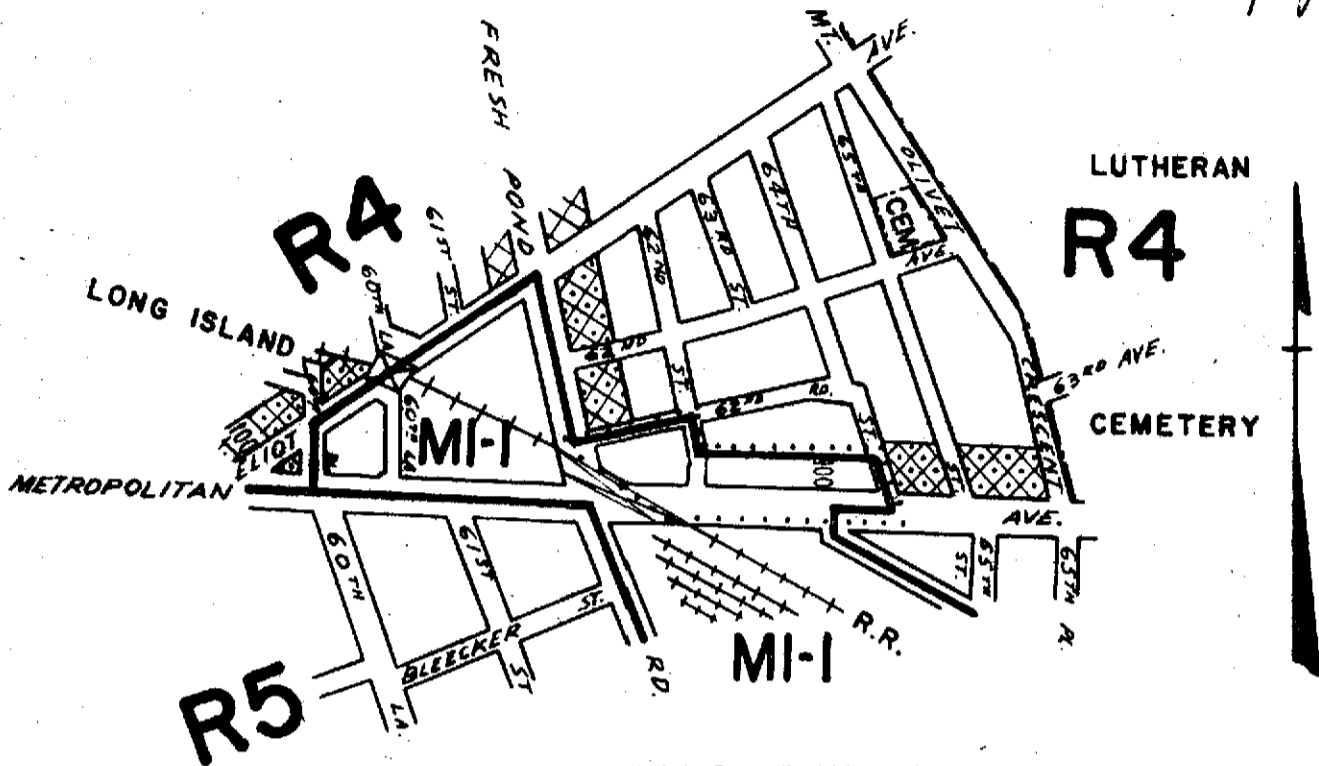

CITY PLANNING COMMISSION  
 CITY OF NEW YORK  
 DIAGRAM SHOWING PROPOSED  
 ZONING CHANGE  
 ON SECTIONAL MAP

13 d

BOROUGH OF  
 QUEENS

New York, January 2, 1964

*Samuel Steinberg*

Secretary

*J. F. Ashworth*  
 Director, Division of Zoning

*J. F. Ashworth*  
 Chief, Office of Technical Controls



NOTE:

- indicates Zoning District boundary.
- The area enclosed by the fine dotted line is proposed to be changed from a C8-1 District to an MI-1 District.
- indicates a C1-2 District.
- indicates a C2-2 District.

FC VAC W

OK FC

OKAP

A-422

EFF date

3/19/64

22

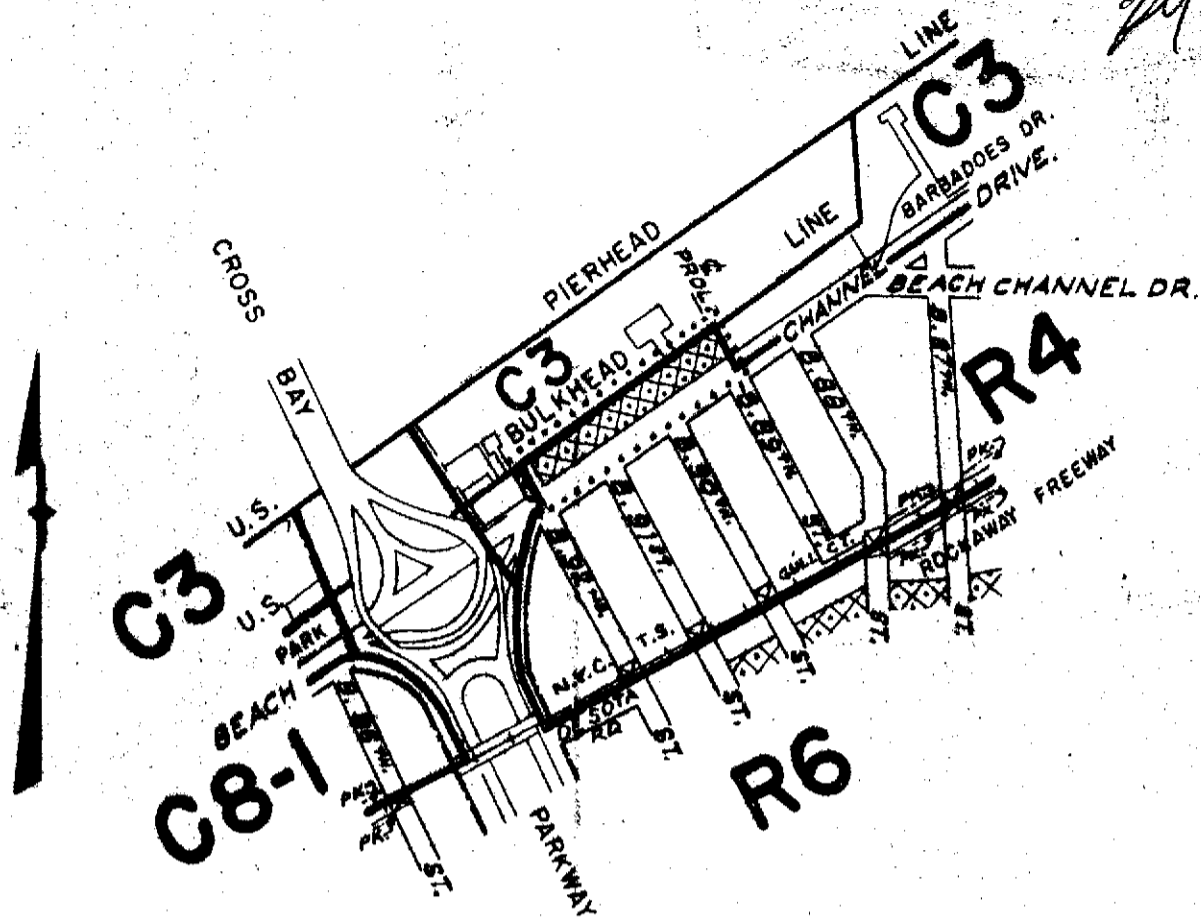

**CITY PLANNING COMMISSION  
CITY OF NEW YORK  
DIAGRAM SHOWING PROPOSED  
ZONING CHANGE  
ON SECTIONAL MAP**

30c

**BOROUGH OF  
QUEENS**

New York, January 2, 1964

*Samuel Steinberg*  
Secretary

*Theophilus*  
Director, Division of Zoning

*J. F. Ashworth*  
Chief, Office of Technical Controls

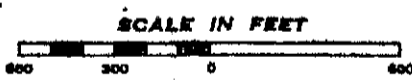

**NOTE:**

- indicates Zoning District boundary.
- The area enclosed by the fine dotted line is proposed to be changed from a C3 District to R4 and C2-2 Districts.
- indicates a C2-2 District.

J.B.

F.C. W

OKAP

SES

A-417

OK

Eff. date Feb. 20-69



C.P. 1822

*[Handwritten signature]*

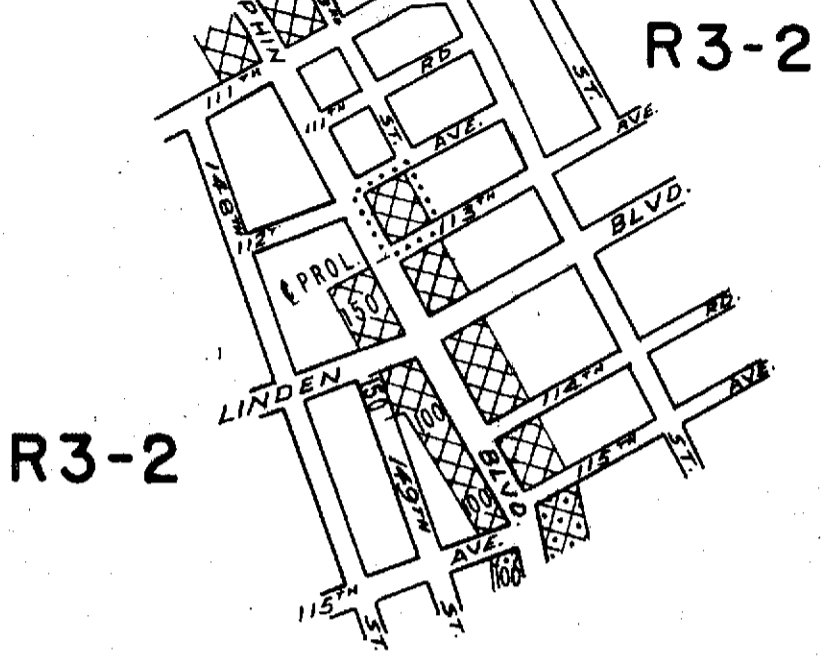

**CITY PLANNING COMMISSION  
CITY OF NEW YORK  
DIAGRAM SHOWING PROPOSED  
ZONING CHANGE  
ON SECTIONAL MAP**

18c ✓

**BOROUGH OF  
QUEENS**

New York, January 2, 1964





*Samuel Steinberg*  
Secretary

*F. De Filippo*  
Director, Division of Zoning

*J. F. Ashworth*  
Chief, Office of Technical Controls



**NOTE:**

-  indicates Zoning District boundary.
-  The area enclosed by the fine dotted line is proposed to be changed by establishing a C1-2 District within an existing R3-2 District.
-  indicates an C1-2 District.
-  indicates an C2-2 District.

*OKAP*

*F C W*  
*OB*  
*A-415*

*OR*

*Feb. 6, 1964*



OKAP

VB

C. P. 18255

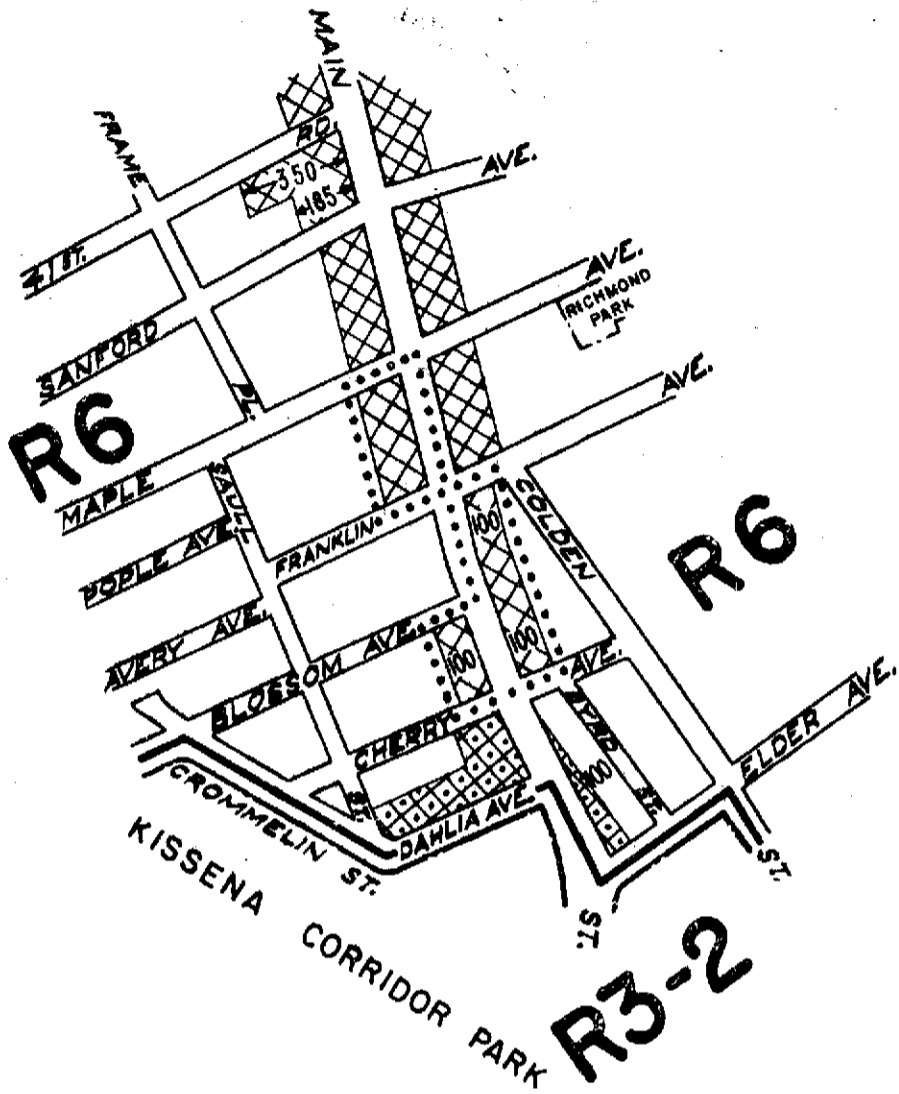

CITY PLANNING COMMISSION  
 CITY OF NEW YORK  
**DIAGRAM SHOWING PROPOSED  
 ZONING CHANGE  
 ON SECTIONAL MAP**

10b

BOROUGH OF  
QUEENS

New York, January 29, 1964

Acting  
Secretary

*Louie Roberts*  
Acting Director, Div. of Zoning

*J. F. Ashworth*  
Chief, Office of Technical Controls

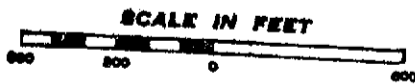

**NOTE:**

- Indicates Zoning District boundary.
- ..... The area enclosed by the fine dotted line is proposed to be changed by Establishing a C1-2 District within an existing R6 District
- ▣ Indicates a C1-2 District
- ▣ indicates a C2-2 District.

4/9/64

A-426

*Jol*

OKAP

C. P. 18256

VB

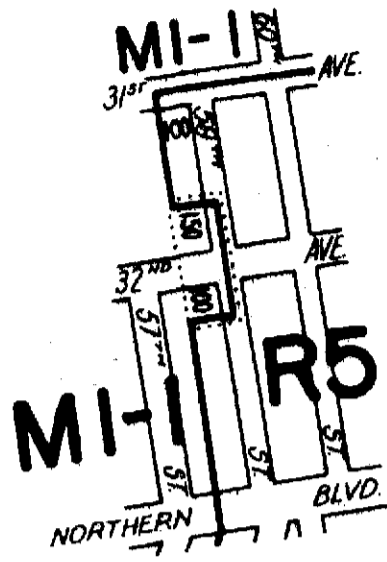

**CITY PLANNING COMMISSION  
CITY OF NEW YORK  
DIAGRAM SHOWING PROPOSED  
ZONING CHANGE  
ON SECTIONAL MAP**

**9d**

**BOROUGH OF  
QUEENS**

New York, January 29, 1964  
*Regina J. Goldstein*  
**ACTING  
Secretary**

*Louie Roberts*  
**Acting Director, Division of Zoning**

*J.F. Ashworth*  
**Chief, Office of Technical Controls**

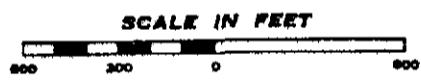

**NOTE:**

- indicates Zoning District boundary.
- .....** The area enclosed by the fine dotted line is proposed to be changed from an R5 District to an MI-1 District.

*AM FC*

*102*

A-427

*JR*

4/9/69

*FC*

VB.  
OKAP

C.P. 1827  
*[Signature]*

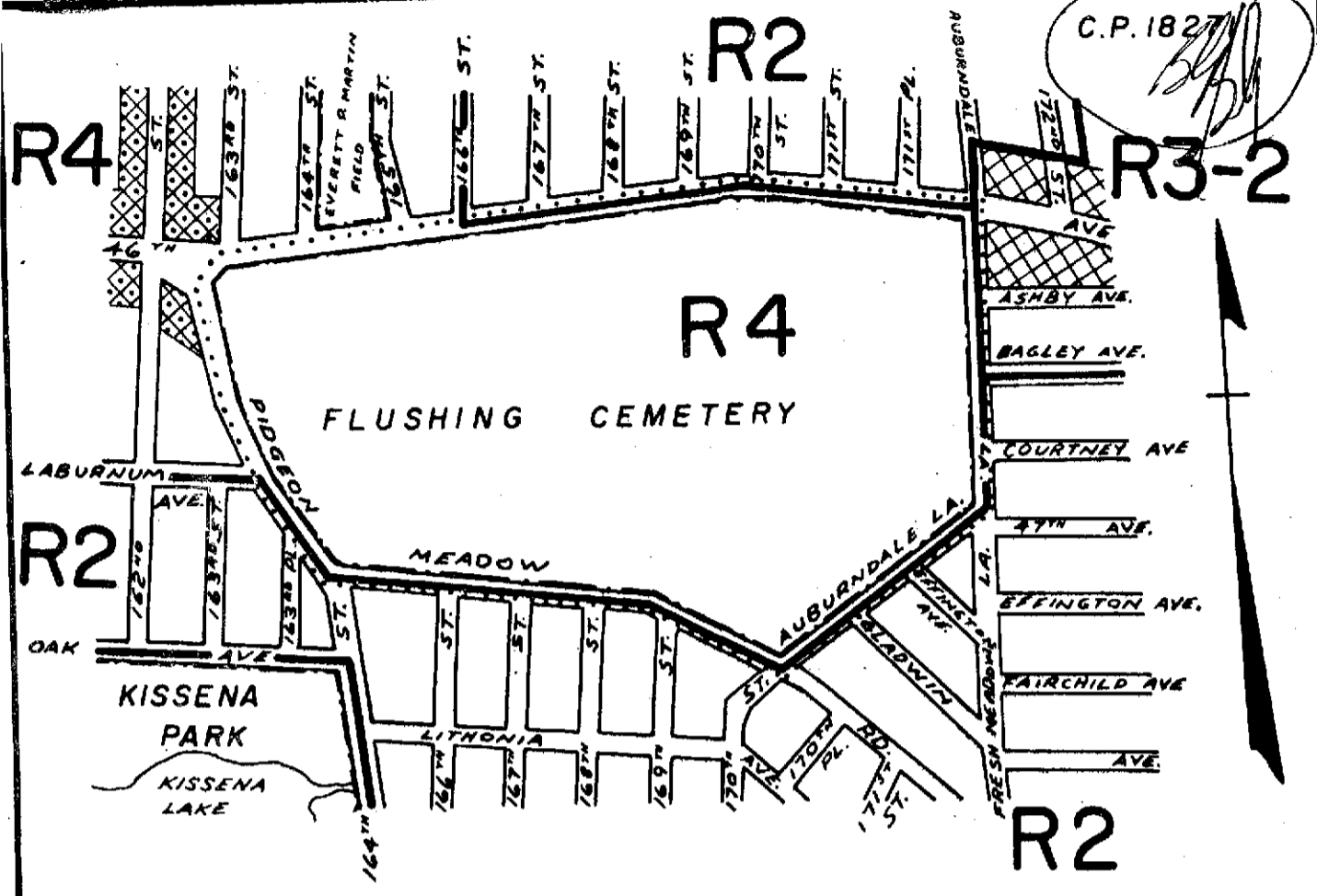

CITY PLANNING COMMISSION  
CITY OF NEW YORK  
**DIAGRAM SHOWING PROPOSED  
ZONING CHANGE  
ON SECTIONAL MAP**

10d ✓  
BOROUGH OF  
QUEENS

*[Signature]*  
S.C.E.  
Director, Division of Zoning

New York, February 11, 1964

*[Signature]*  
Secretary

*[Signature]*  
Chief, Office of Technical Controls

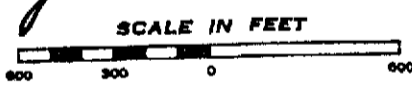

- NOTE:**
- indicates Zoning District boundary.
  - The area enclosed by the fine dotted line is proposed to be changed from an R2 District to an R4 District.
  - indicates a C1-2 District.
  - indicates a C2-2 District.

N.A.P. ✓ HC FC ✓

*[Signature]*

A-435

OK

4/9/64

SKAP

VB

C. P. 8315

C4-2

R7-1

R7-1

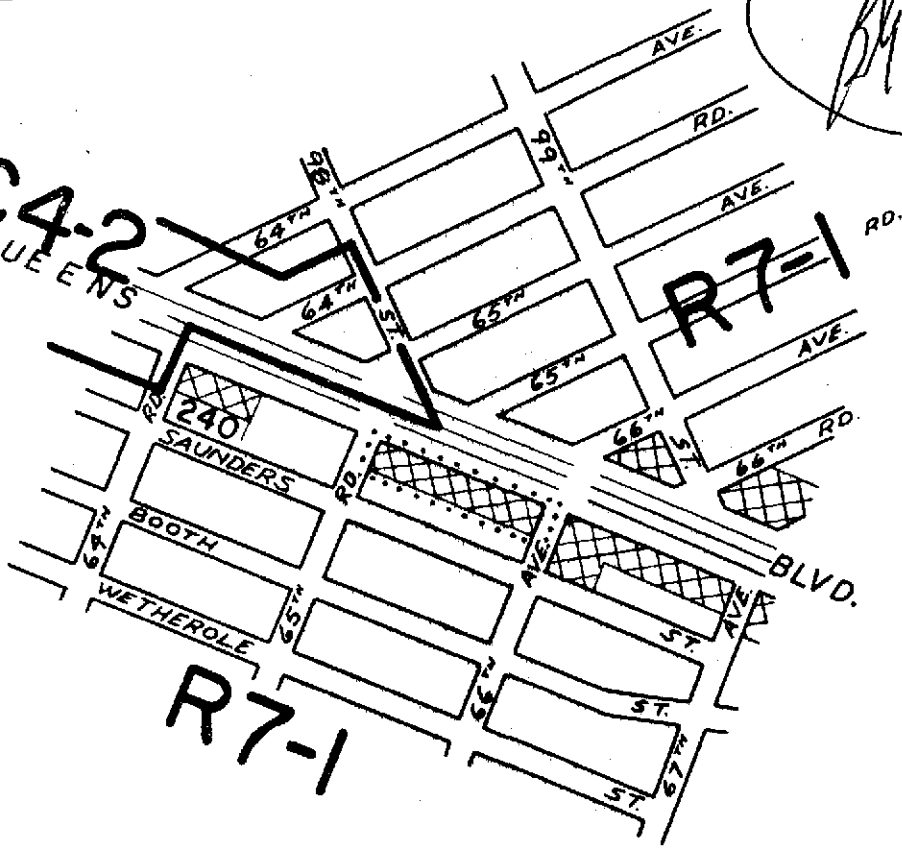

CITY PLANNING COMMISSION  
 CITY OF NEW YORK  
 DIAGRAM SHOWING PROPOSED  
 ZONING CHANGE  
 ON SECTIONAL MAP

140  
 BOROUGH OF  
 QUEENS

New York, February 26, 1964

Secretary

*J. DeT...*  
 S.C.E.  
 Director, Division of Zoning

*J. F. Ashworth*  
 Chief, Office of Technical Controls

SCALE IN FEET

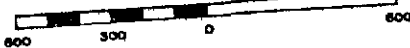

NOTE:

- indicates Zoning District boundary.
- The area enclosed by the fine dotted line is proposed to be changed by establishing a C1-2 District within an existing R7-1 District.
- indicates an C1-2 District.

N.A.P.

FC

A-436

9/9/64

F.C.

OK

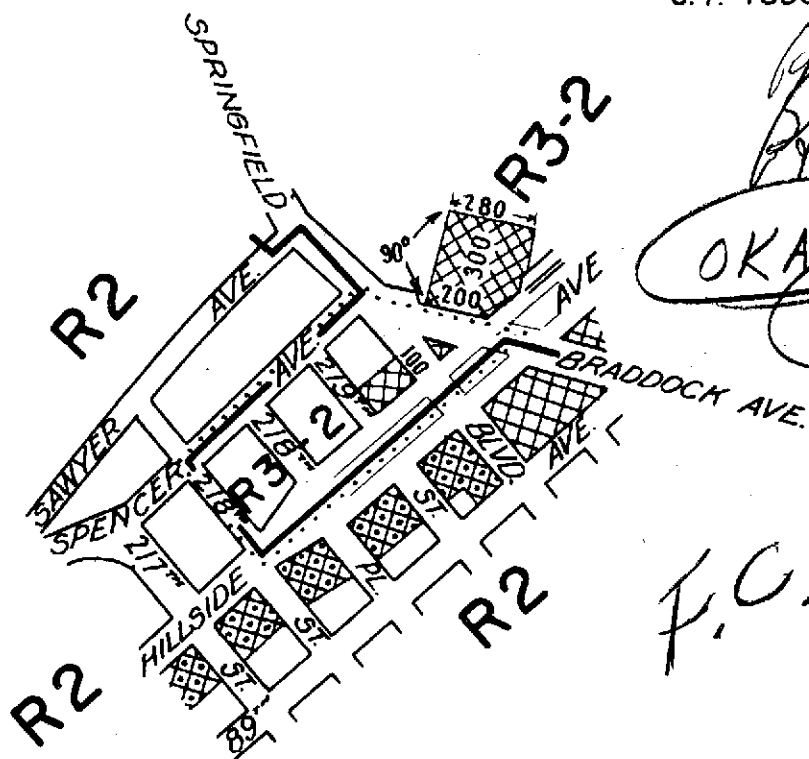

OKAR  
V

F.C.

CITY PLANNING COMMISSION  
 CITY OF NEW YORK  
 DIAGRAM SHOWING PROPOSED  
 ZONING CHANGE  
 ON SECTIONAL MAP

15a

BOROUGH OF QUEENS

New York, March 11, 1964

Samuel Stenberg  
Secretary

F. DeToloff  
Director, Division of Zoning

J. F. Ashworth  
Chief, Office of Technical Controls

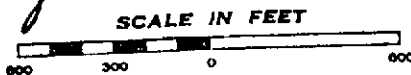

NOTE:

- indicates Zoning District boundary.
- The area enclosed by the fine dotted line is proposed to be changed from an R2 District to R3-2 and C1-2 Districts.
- indicates a C1-2 District.
- indicates a C2-2 District.

REM FC vH

OK

of Date June 11, 1964

A-455

Rush out

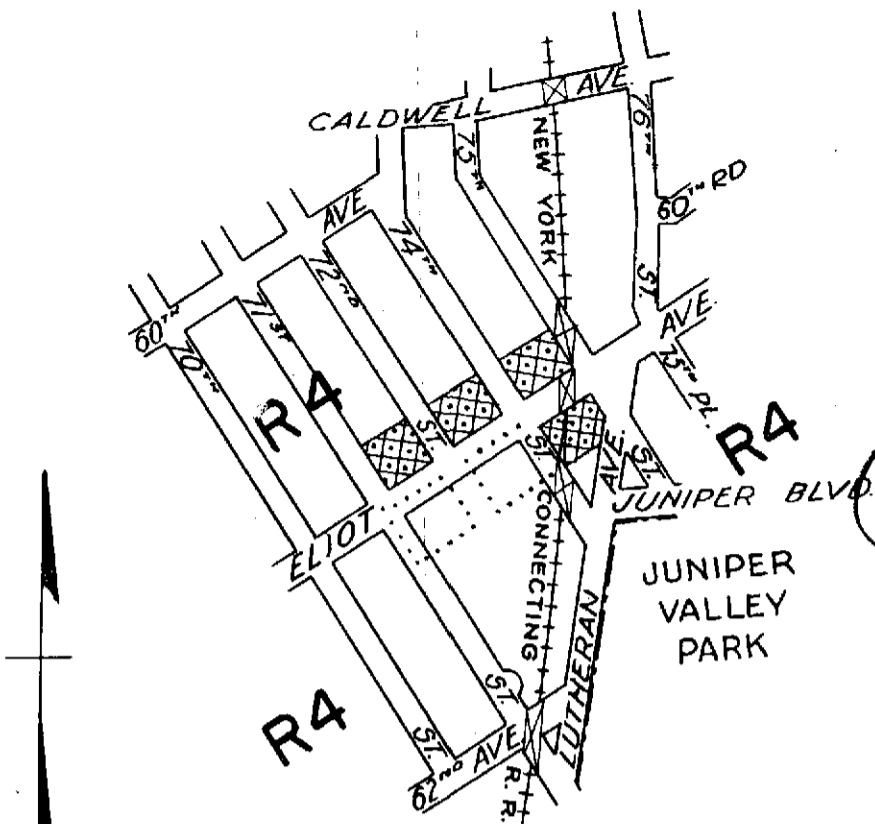

VB  
 OKAP

CITY PLANNING COMMISSION  
 CITY OF NEW YORK  
 DIAGRAM SHOWING PROPOSED  
 ZONING CHANGE  
 ON SECTIONAL MAP

13c  
 BOROUGH OF  
 QUEENS

New York, April 1, 1964



*Samuel Steinberg*  
 Secretary

*F. De Filippo*  
 S.A.C.E.  
 Director, Division of Zoning

*J. F. Ashworth*  
 Chief, Office of Technical Controls



NOTE:

-  indicates Zoning District boundary.
-  The area enclosed by the fine dotted line is proposed to be changed by the elimination of a C2-2 District within an existing R4 District.
-  indicates a C2-2 District.

*CSM*

*F.C.*

*5/14/69*

*A-449*

3

C.P. 18392

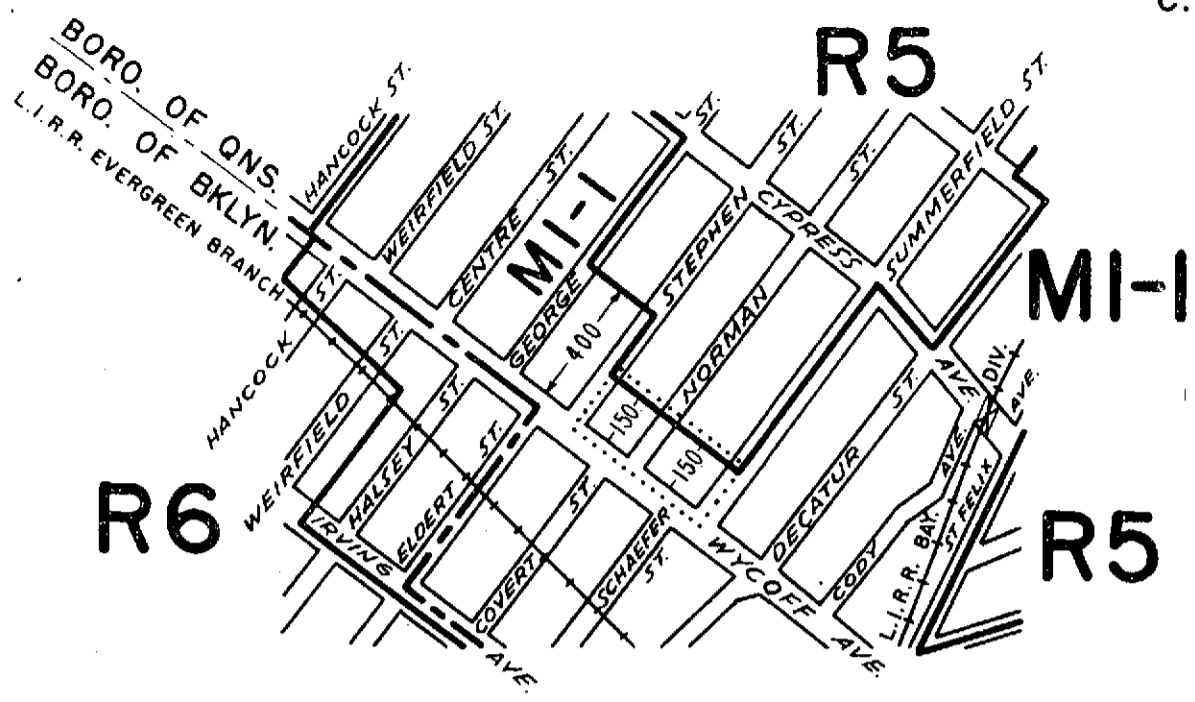

CITY PLANNING COMMISSION  
 CITY OF NEW YORK  
**DIAGRAM SHOWING PROPOSED  
 ZONING CHANGE  
 ON SECTIONAL MAP**

13 d ✓  
 BOROUGH OF  
 QUEENS

New York, April 29, 1964

*Samuel Steinberg*  
 Secretary

*F. De Filippo*  
 Director, Division of Zoning  
*Nathan Ginsberg*  
 Act. Chief, Office of Technical Controls

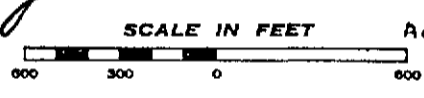

**NOTE:**

- indicates Zoning District boundary.
- .....** The area enclosed by the fine dotted line is proposed to be changed from an R5 District to an MI-1 District.

A-464      E Date June 25, 64  
 30 day ends July 4, 64



4

C.P. 18397

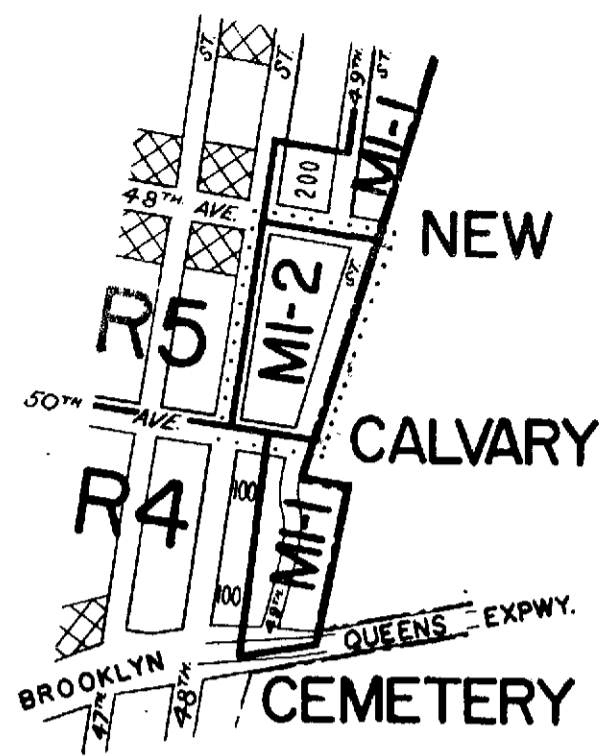

*[Handwritten signature]*



CITY PLANNING COMMISSION  
 CITY OF NEW YORK  
**DIAGRAM SHOWING PROPOSED  
 ZONING CHANGE  
 ON SECTIONAL MAP**

9b & 13a ✓  
 BOROUGH OF  
 QUEENS

New York, April 29, 1964

*Samuel Steinberg*  
 Secretary

*F. De Filippo*  
 Director, Division of Zoning

*Nathan Ginsberg*  
 Act. Chief, Office of Technical Controls

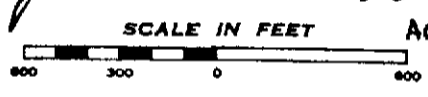

**NOTE:**

- indicates Zoning District boundary.
- The area enclosed by the fine dotted line is proposed to be changed from an MI-1 District to an MI-2 District.
- indicates an C1-2 District.

R.C.

A-465

OK

E.D.

E.D.

~~June~~ June 25, 64

30 day ends July 4, 64

① first

C.P. 18431

R3-2

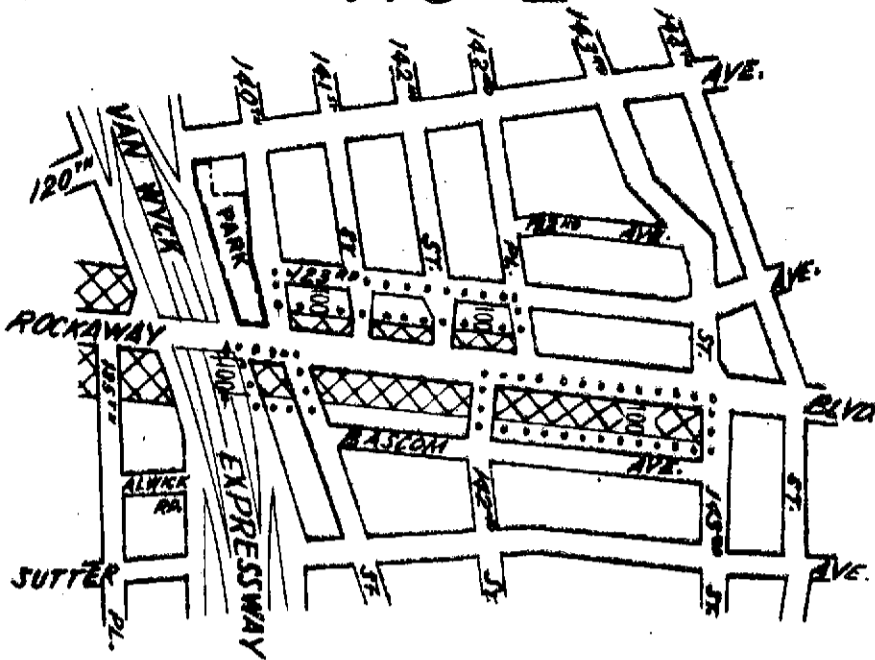

R3-2

CITY PLANNING COMMISSION  
 CITY OF NEW YORK  
 DIAGRAM SHOWING PROPOSED  
 ZONING CHANGE  
 ON SECTIONAL MAP  
 18c ✓

BOROUGH OF  
QUEENS

New York, May 20, 1964

*Samuel Steinberg*  
Secretary



*Frank J. Felippa*  
Director, Division of Zoning

*J. F. Ashworth*  
Chief, Office of Technical Controls

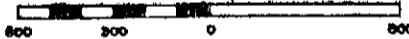
SCALE IN FEET



**NOTE:**

-  indicates Zoning District boundary.
-  The area enclosed by the fine dotted line is proposed to be changed by eliminating and establishing C1-2 Districts within an existing R3-2 District.
-  indicates an C1-2 District.

B.G.

*of date July 23, 1964*

*A-473*

*300 day ends July 18, 1964*

2

C.P. 18437

B.G.P.

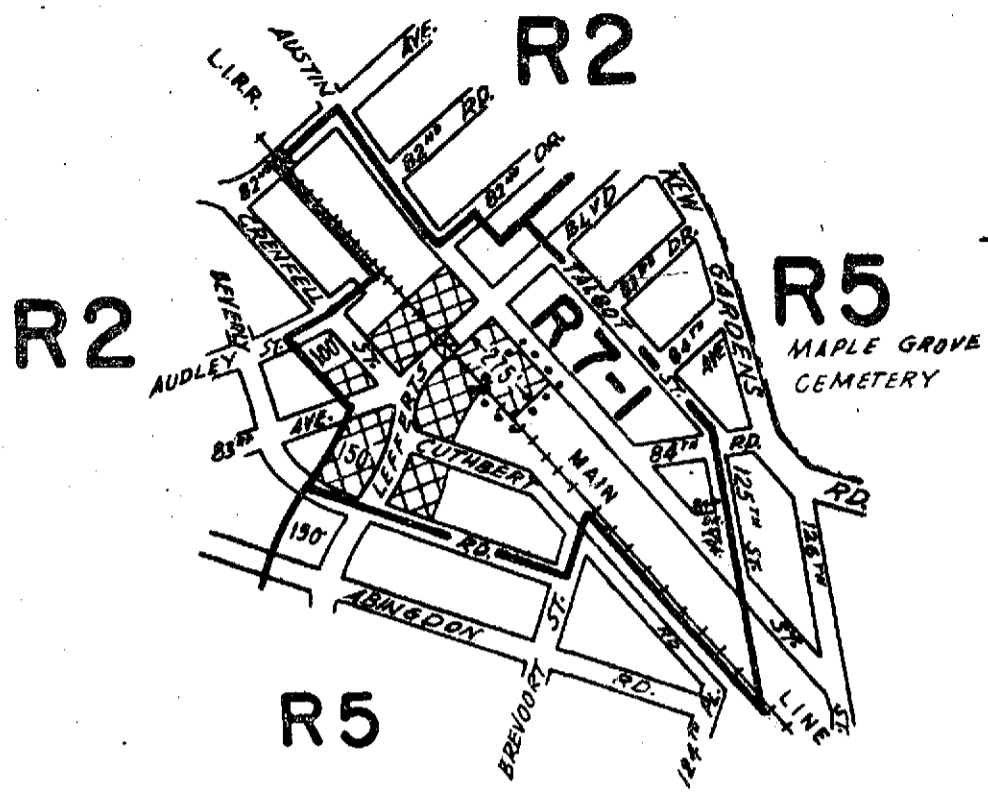

CITY PLANNING COMMISSION  
 CITY OF NEW YORK  
**DIAGRAM SHOWING PROPOSED  
 ZONING CHANGE  
 ON SECTIONAL MAP  
 14 b**

BOROUGH OF  
 QUEENS

New York, May 20, 1964

*Samuel Steinberg*  
 Secretary

*F. DeFilippo*  
 Director, Division of Zoning

*J.F. Ashworth*  
 Chief, Office of Technical Controls



- NOTE:**
- indicates Zoning District boundary.
  - ..... The area enclosed by the fine dotted line is proposed to be changed by establishing a CI-2 District within an existing R7-1 District.
  - ▨ indicates a CI-2 District.

B.G. F.C. S.C.D.W

A-474

E. Date  
 July 23 1964

30 day ends July 18, 64

9

C.P. 18438

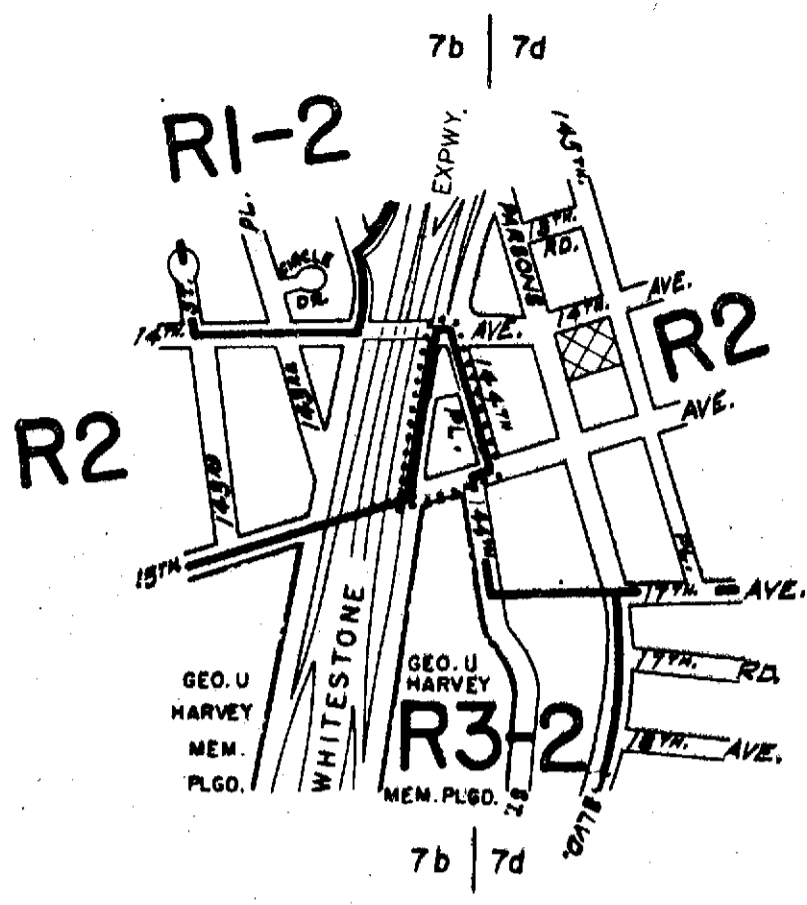

CITY PLANNING COMMISSION  
 CITY OF NEW YORK  
**DIAGRAM SHOWING PROPOSED  
 ZONING CHANGE  
 ON SECTIONAL MAP**

7b  
 BOROUGH OF  
 QUEENS

New York, May 20, 1964

*Samuel Stariberg*  
 Secretary

*F. DeFilippis*  
 Director, Division of Zoning  
*J.F. Ashworth*  
 Chief, Office of Technical Controls

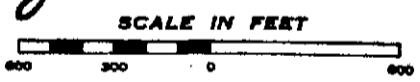

- NOTE:**
- indicates Zoning District boundary.
  - The area enclosed by the fine dotted line is proposed to be changed from an R2 District to an R3-2 District.
  - indicates a CI-2 District.

J.B. F.C. ✓

A-469 E.D. June 25, 1964  
 30 day ends July 18-1964

C. P. 18461

*89/DA*

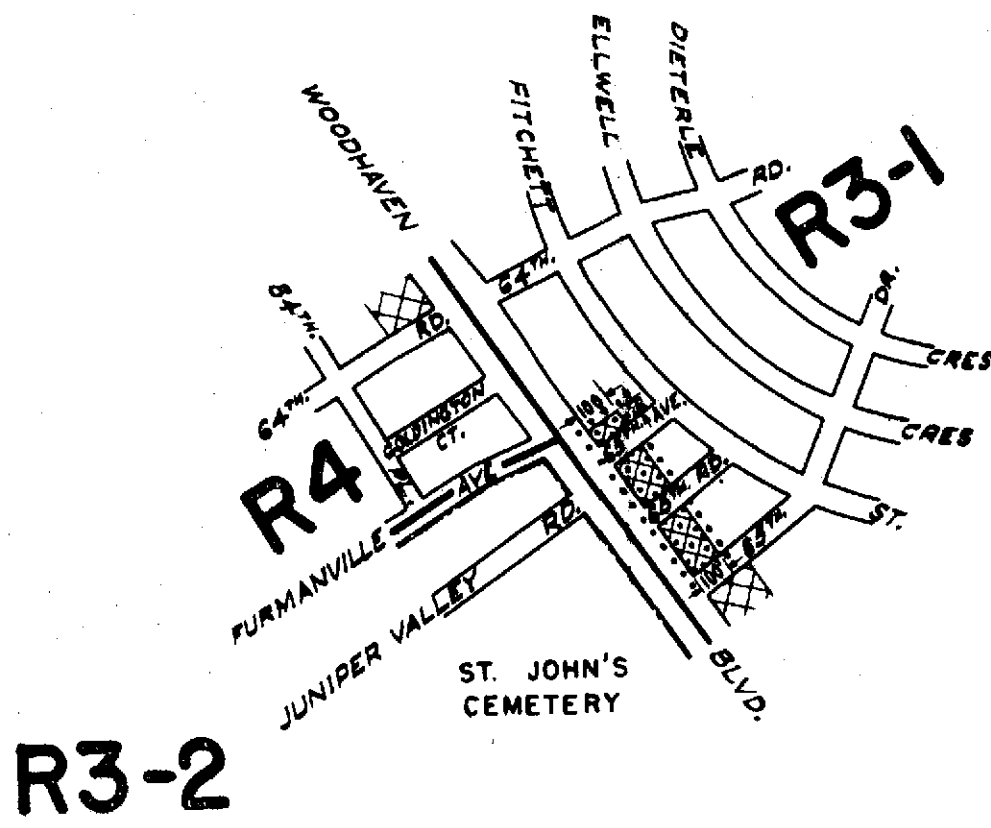

CITY PLANNING COMMISSION  
 CITY OF NEW YORK  
**DIAGRAM SHOWING PROPOSED  
 ZONING CHANGE  
 ON SECTIONAL MAP**

140

BOROUGH OF  
QUEENS



New York, June 3, 1964

*Stephanie Goldstein*  
Acting  
Secretary

*John J. Lippe*  
Director, Division of Zoning

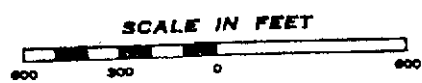
*J. F. Ashworth*  
Chief, Office of Technical Controls



- NOTE:**
- indicates Zoning District boundary.
  - ..... The area enclosed by the fine dotted line is proposed to be changed by establishing a C2-2 District within an existing R3-1 District.
  -  indicates a C1-2 District.
  -  indicates a C2-2 District.

*JB F.C. VHC W*

*A-480*

*Aug. 20, 64*

*③ Rush*

*VJT  
FC*

3

C. P. 18462

*[Handwritten initials]*

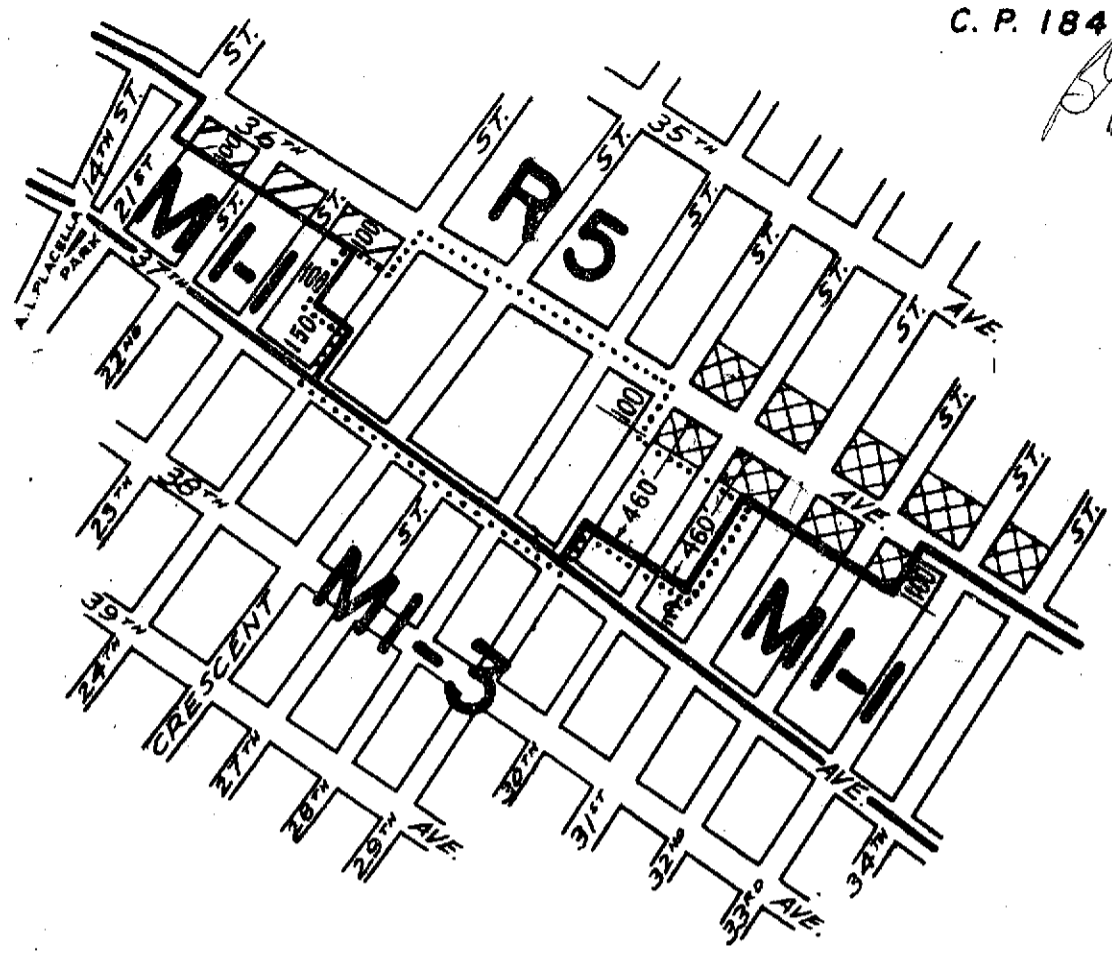

**CITY PLANNING COMMISSION  
CITY OF NEW YORK  
DIAGRAM SHOWING PROPOSED  
ZONING CHANGE  
ON SECTIONAL MAP**

**9 b**

**BOROUGH OF  
QUEENS**

*[Signature]*  
Director, Division of Zoning

*[Signature]*  
Chief, Office of Technical Controls

New York, June 3, 1964  
*[Signature]*  
Acting Secretary



- NOTE:**
- indicates Zoning District boundary.
  - The area enclosed by the fine dotted line is proposed to be changed from an MI-1 District to an R-5 District.
  - Indicates a CI-2 District.
  - indicates a CI-3 District.

C.H. F.C. VRB ✓

E.D. July 23, 64 ✓  
30 day ends Aug. 15, 64

82  
m  
A-477 ✓

4

C.P. 18469

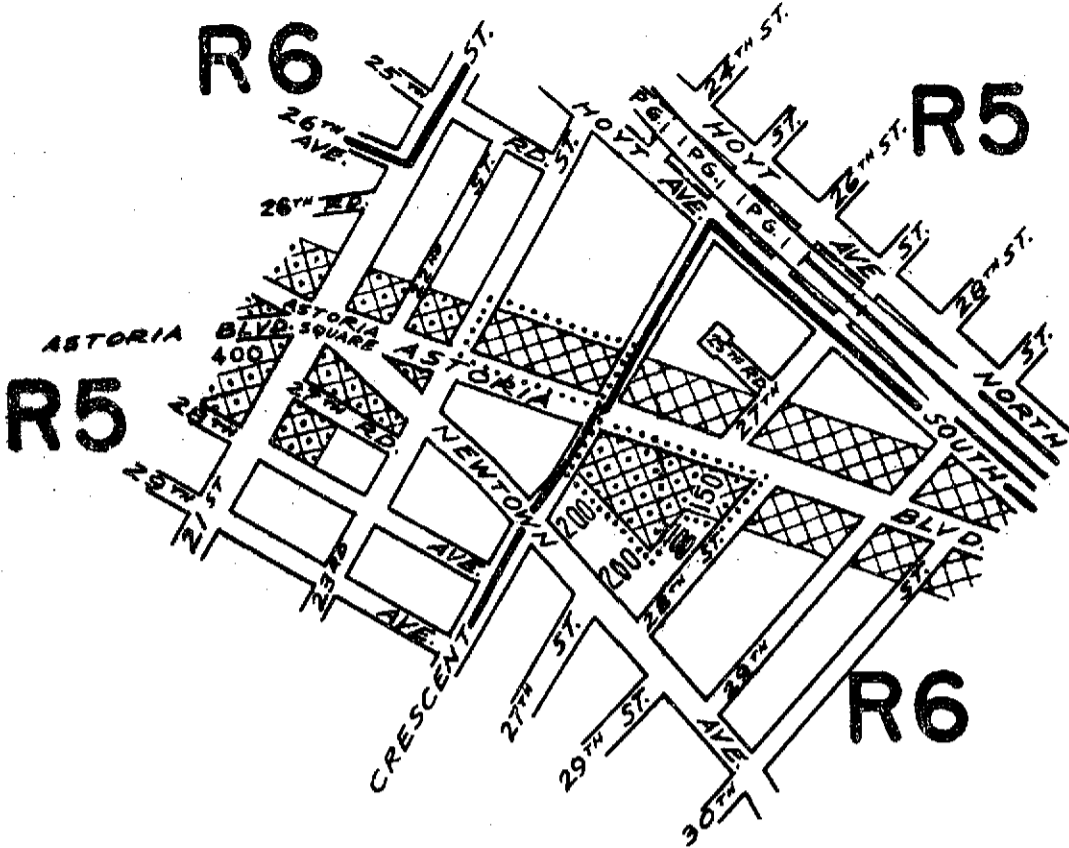

CITY PLANNING COMMISSION  
 CITY OF NEW YORK  
**DIAGRAM SHOWING PROPOSED  
 ZONING CHANGE  
 ON SECTIONAL MAP**

90 ✓  
 BOROUGH OF  
 QUEENS

New York, June 3, 1964



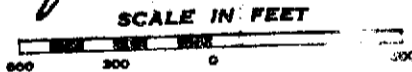

*Samuel Steinberg*  
 Secretary

*F. De Filippo*  
 Director, Division of Zoning

*J. F. Ashworth*  
 Chief, Office of Technical Controls



**NOTE:**

-  indicates Zoning District boundary.
-  The area enclosed by the fine dotted line is proposed to be changed by establishing a C1-2 District within an existing R-5 District and by eliminating a C1-2 District and establishing a C2-2 District within an existing R6 District.
-  indicates a C1-2 District.
-  indicates a C2-2 District.

C.H.

F.C. W

OK

ED. July 23, 64 ✓

OK

A-47P ✓

30 day ends Aug. 15, 64

C.P. 18470

MI-1

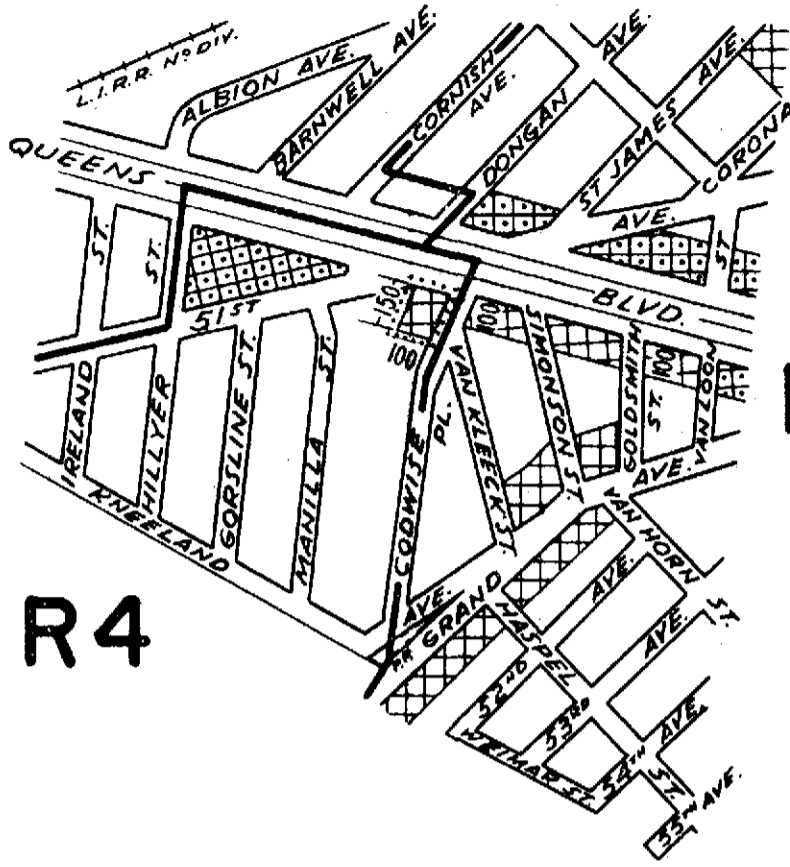

R6

R4

CITY PLANNING COMMISSION  
 CITY OF NEW YORK  
 DIAGRAM SHOWING PROPOSED  
 ZONING CHANGE  
 ON SECTIONAL MAP  
 13c ✓

BOROUGH OF  
QUEENS

New York, June 3, 1964

*A. J. Goldstein*  
 Acting Secretary

*J. F. Ashworth*  
 Director, Div. Mapping & Zoning

*J. F. Ashworth*  
 Chief, Office of Technical Controls

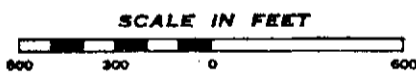

NOTE:

- indicates Zoning District boundary.
- ..... The area enclosed by the fine dotted line is proposed to be changed by establishing a C1-2 District within an existing R4 District.
- ▣ indicates a C1-2 District.
- ▣ indicates a C2-2 District.

④

A-481

*Rush*

Aug 20, 1964

*VJT  
f.c.*



C.P. 18491

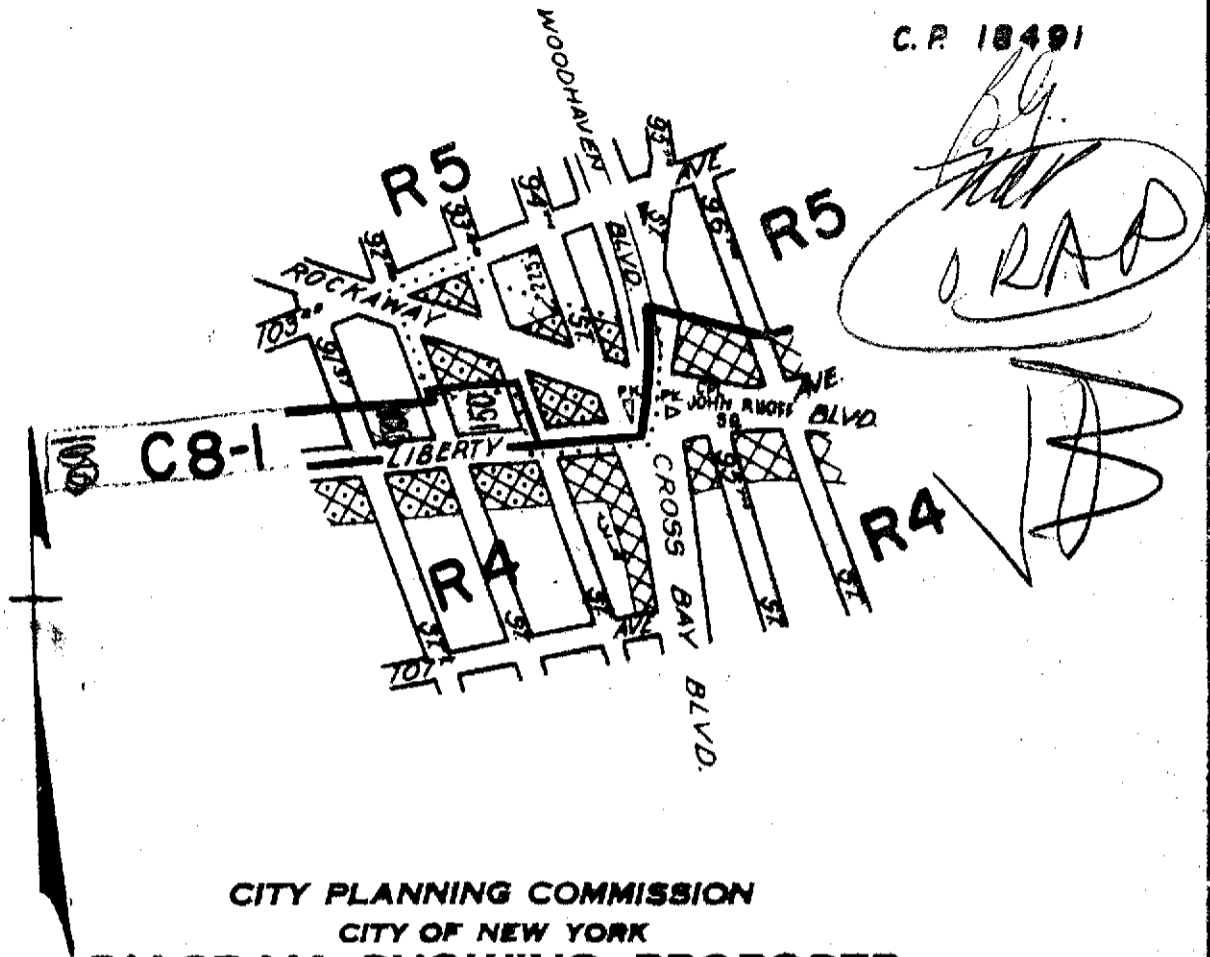

CITY PLANNING COMMISSION  
 CITY OF NEW YORK  
**DIAGRAM SHOWING PROPOSED  
 ZONING CHANGE  
 ON SECTIONAL MAP**

MODIFIED BY BD OF EST.  
 SEPT. 24 1964 (CAL NO 28)

18a  
 BOROUGH OF  
 QUEENS

New York, June 17, 1964.

*Louis Steinberg*  
 Secretary

*F. J. Ashworth*  
 Director, Division of Zoning

*J. F. Ashworth*  
 Chief, Office of Technical Controls

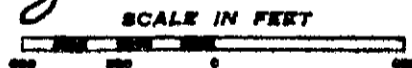

**NOTE:**

- Indicates Zoning District boundary.
- The area enclosed by the fine dotted line is proposed to be changed from a C8-1 District to R5 and C2-2 Districts.
- indicates a C1-2 District.
- indicates a C2-2 District.

*cm F.C. / HC*

*A-488*

*E Date  
 Sept 24, 1964*

*30 day  
 ends 9-12-64*

OKAP  
✓  
WLP 8/16

R3-2

R4

R4

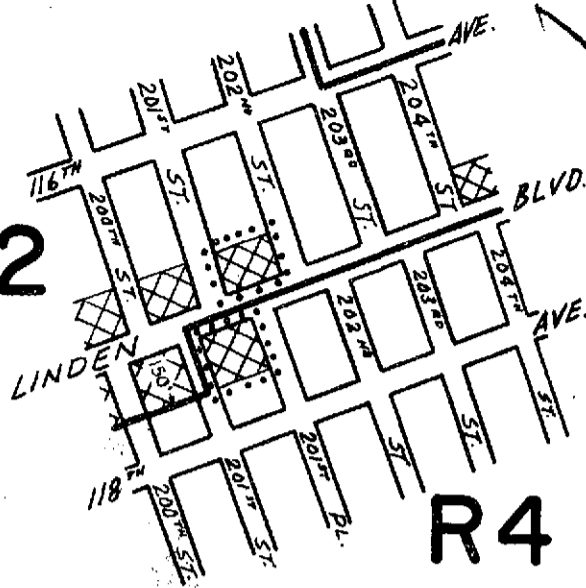

CITY PLANNING COMMISSION  
CITY OF NEW YORK  
DIAGRAM SHOWING PROPOSED  
ZONING CHANGE  
ON SECTIONAL MAP

15b ✓  
BOROUGH OF  
QUEENS

New York, July 15, 1964

*Samuel Steinberg*  
Secretary

*The Filippini-S. Co.*  
Director, Division of Zoning

*J. F. Ashworth*  
Chief, Office of Technical Controls

SCALE IN FEET



NOTE:

- indicates Zoning District boundary.
- ..... The area enclosed by the fine dotted line is proposed to be changed by establishing a C1-2 District within existing R3-2 and R4 Districts.
- ▣ indicates a C1-2 District.

B.G.

F

OK

30 day order

10-17-64

A-493

08 8, 64  
/

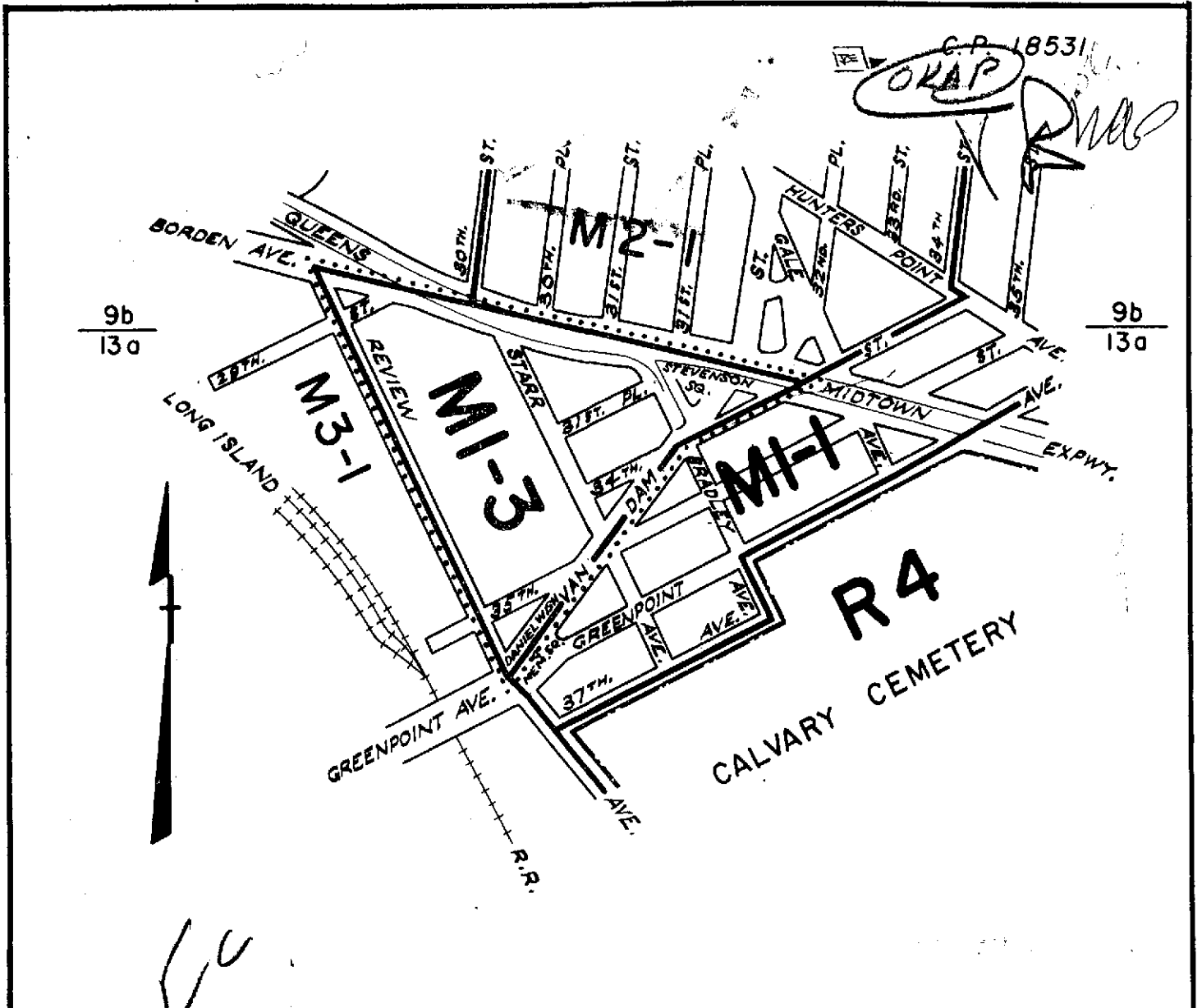

CITY PLANNING COMMISSION  
CITY OF NEW YORK  
**DIAGRAM SHOWING PROPOSED  
ZONING CHANGE  
ON SECTIONAL MAP**

**9b & 13a** ✓  
BOROUGH OF  
QUEENS

New York, JULY 15, 1964

*Samuel Starobin*  
Secretary

*F. De Filippo, Sr. C.E.*  
Director, Division of Zoning

*J. F. Ashworth*  
Chief, Office of Technical Controls



- NOTE:**
- indicates Zoning District boundary.
  - ..... The area enclosed by the fine dotted line is proposed to be changed from an M1-1 District to an M1-3 District.

J.B. K

A - 499

30 day order  
10-17, 64

Oct 8, 64 *mm*

OKAP C.P. 18532

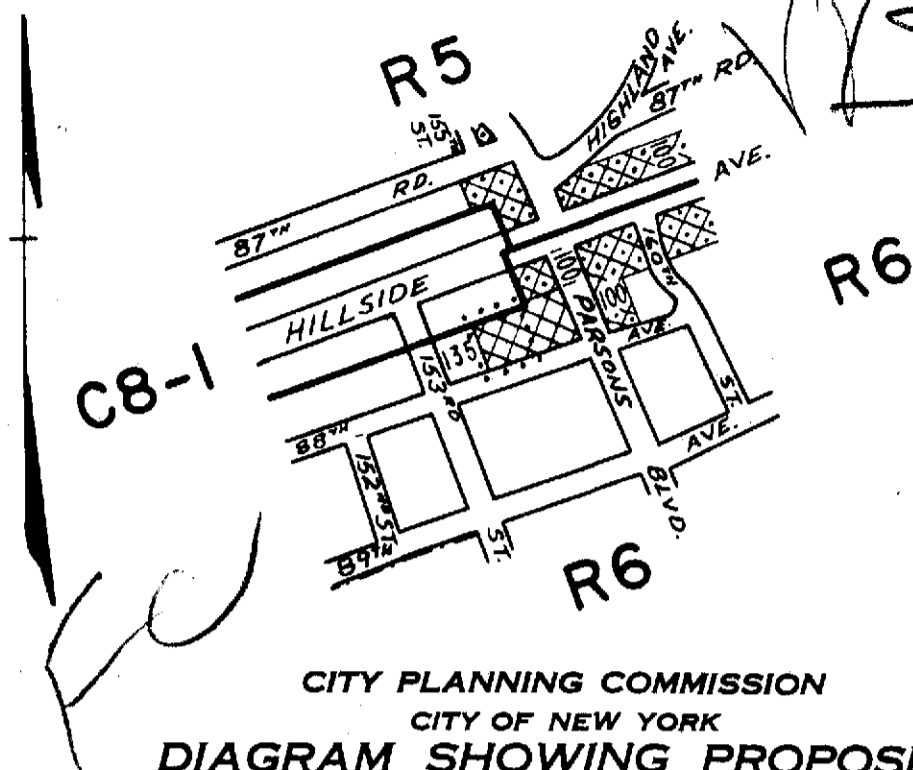

CITY PLANNING COMMISSION  
 CITY OF NEW YORK  
**DIAGRAM SHOWING PROPOSED  
 ZONING CHANGE  
 ON SECTIONAL MAP**

14d ✓

BOROUGH OF  
QUEENS

New York, July 15, 1964

*Samuel Steinberg*

Secretary

*F. De Filippo, S.C.E.*  
Director, Division of Zoning

*J. F. Ashworth*

Chief, Office of Technical Controls

SCALE IN FEET



**NOTE:**

- indicates Zoning District boundary.
- ..... The area enclosed by the fine dotted line is proposed to be changed by establishing a C1-2 District within an existing R6 District.
- ⊠ indicates a C1-2 District.
- ◊ indicates a C2-2 District.

N.A.P. *J.P.*

*or*

*30 day ends*

*10-17-64*

*A-495*

*Oct 8, 64*

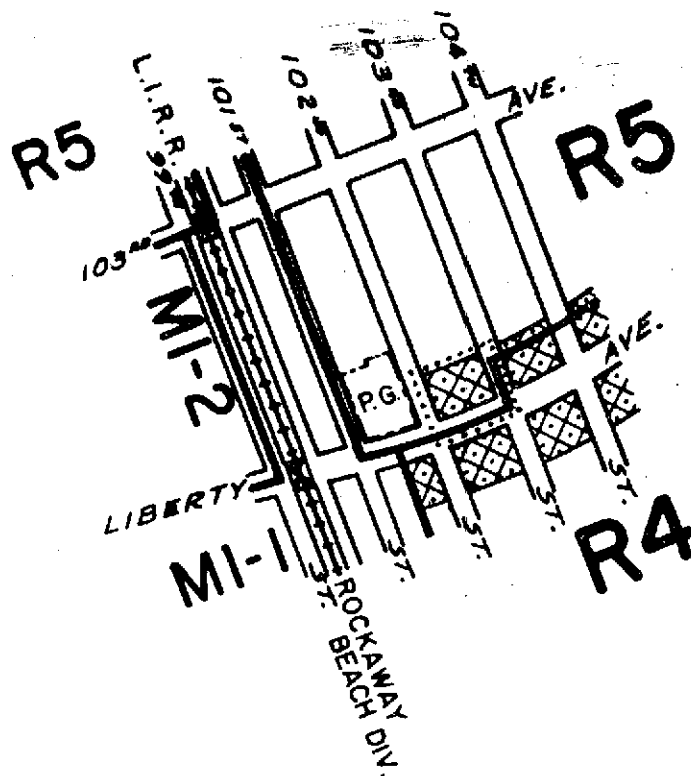

*Handwritten signatures and initials:*  
 Top right: *W. J. ...*  
 Middle right: *FC*  
 Below *FC*: *OK MR* (circled) and *VB*  
 Right side: North arrow pointing up.

**CITY PLANNING COMMISSION  
 CITY OF NEW YORK  
 DIAGRAM SHOWING PROPOSED  
 ZONING CHANGE  
 ON SECTIONAL MAP  
 18a**

**BOROUGH OF  
 QUEENS**

New York, August 12, 1964



*Samuel Steinberg*  
 Secretary

*F. De Filippo, Sr.*  
 Director, Division of Zoning

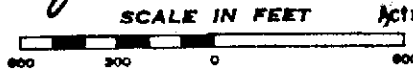
*Nathan Ginzberg*  
 Acting Chief, Office of Technical Controls



**NOTE:**

-  indicates Zoning District boundary.
-  The area enclosed by the fine dotted line is proposed to be changed from an R4 District to an R5 District.
-  indicates a C2-2 District.

*sr F.C. 806*

*30 day  
 10/31/69*

*A-506*

*E.D. 11/19/69*

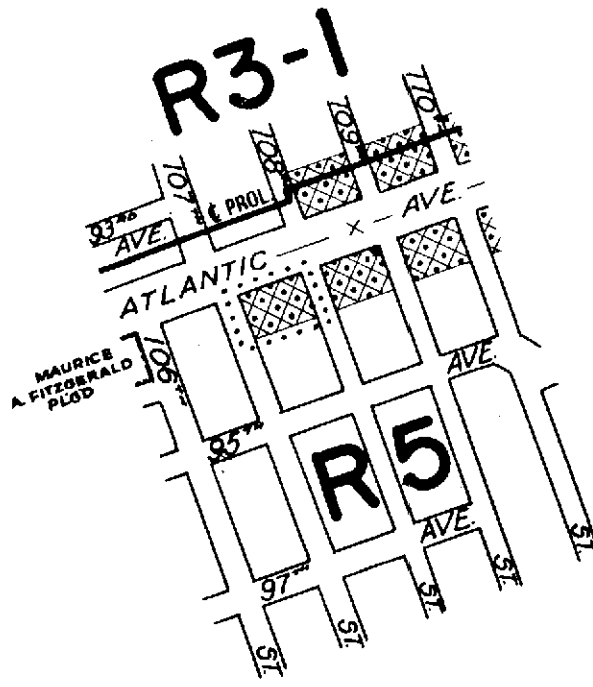

*map*  
*OKAP*  
*F.C.*

CITY PLANNING COMMISSION  
 CITY OF NEW YORK  
 DIAGRAM SHOWING PROPOSED  
 ZONING CHANGE  
 ON SECTIONAL MAP  
 18a

BOROUGH OF  
 QUEENS

New York, September 15, 1964

*Samuel Steinberg*  
 Secretary

*J. F. Ashworth*  
 Director, Division of Zoning

*J. F. Ashworth*  
 Chief, Office of Technical Controls



NOTE:

- indicates Zoning District boundary.
- ..... The area enclosed by the fine dotted line is proposed to be changed by establishing a C2-2 District within an existing R5 District.
-  indicates a C2-2 District.

*CSM F.C. 11/19/64*

*A-507*

*E. D. 11/19/64*

*30 day ends  
 11/19/64*

*OR*

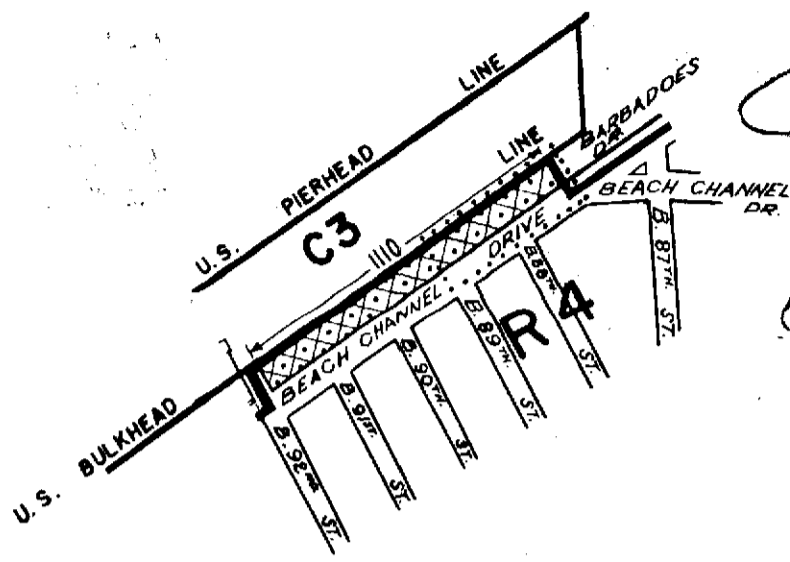

OKAP  
 VB  
 CP. 18585

CITY PLANNING COMMISSION  
 CITY OF NEW YORK  
**DIAGRAM SHOWING PROPOSED  
 ZONING CHANGE  
 ON SECTIONAL MAP**

30c  
 BOROUGH OF  
 QUEENS

New York, September 15, 1964

*Samuel Steinberg*  
 Secretary

*F. De Filippo*  
 Director, Division of Zoning

*J. F. Ashworth*  
 Chief, Office of Technical Controls

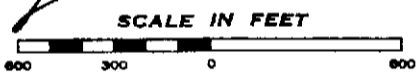

- NOTE:**
- indicates Zoning District boundary.
  - The area enclosed by the fine dotted line is proposed to be changed from a C3 District to C2-2 and R4 Districts.
  - indicate a C2-2 District.

R.C. F.C.

30 day  
 11/27/69

A-508

E.D. 11/19/69.

OKAP

C.P. 18589

R2

VB

Handwritten initials and a small diagram.

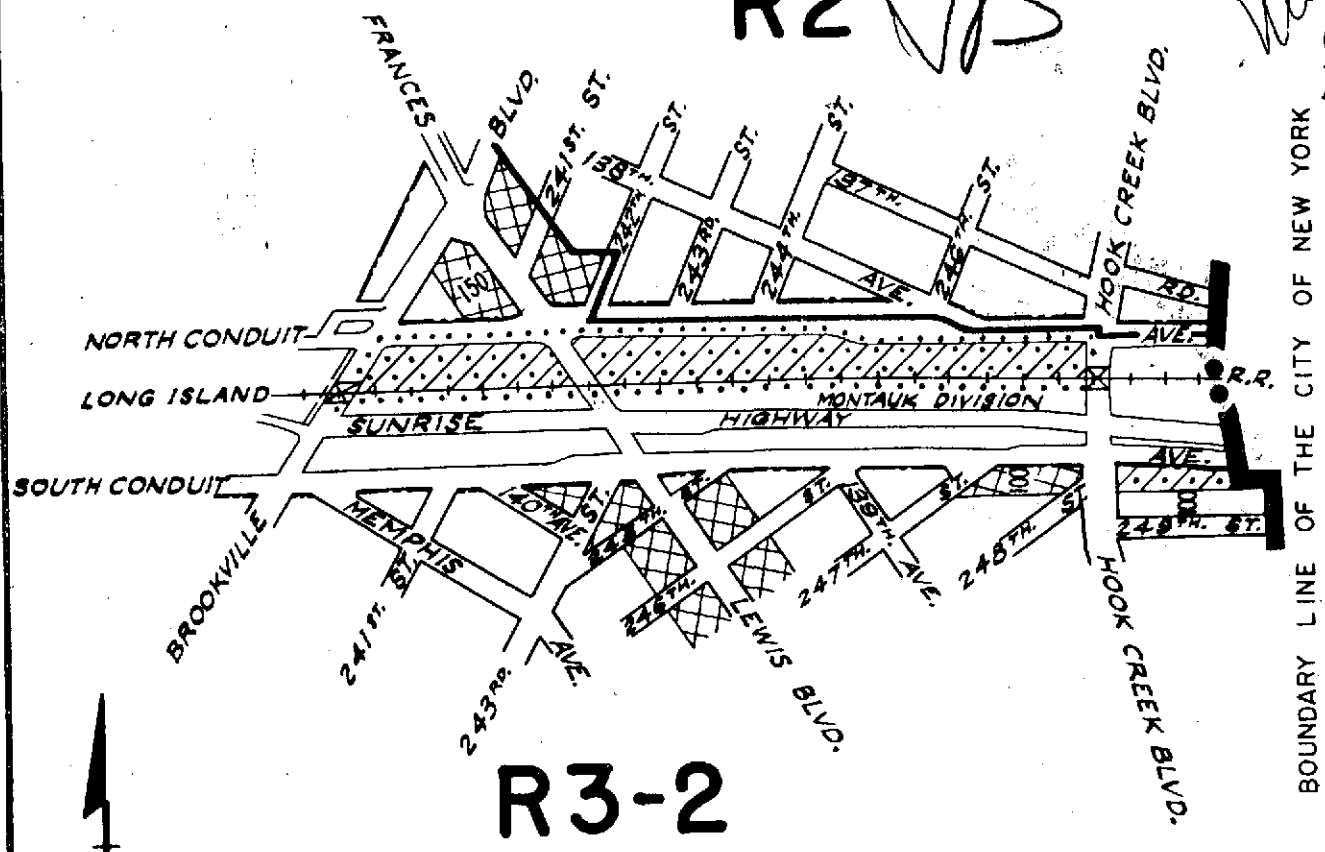

R3-2

CITY PLANNING COMMISSION  
 CITY OF NEW YORK  
**DIAGRAM SHOWING PROPOSED ZONING CHANGE**  
**ON SECTIONAL MAP**  
 19b & 19d  
 BOROUGH OF QUEENS

New York, September 15, 1964

*Samuel Steinberg*  
 Secretary

*F. De Filippo*  
 Director, Division of Zoning

*J. F. Ashworth*  
 Chief, Office of Technical Controls



**NOTE:**

- indicates Zoning District boundary.
- The area enclosed by the fine dotted line is proposed to be changed by establishing a C2-1 district within an existing R3-2 district.
- indicates a C2-1 district.
- indicates a C1-2 district.

J.B. F.C.

A-502 ✓  
 E.F. Date 10/22/64 ✓  
 30 day ends. 11/14/69

OK



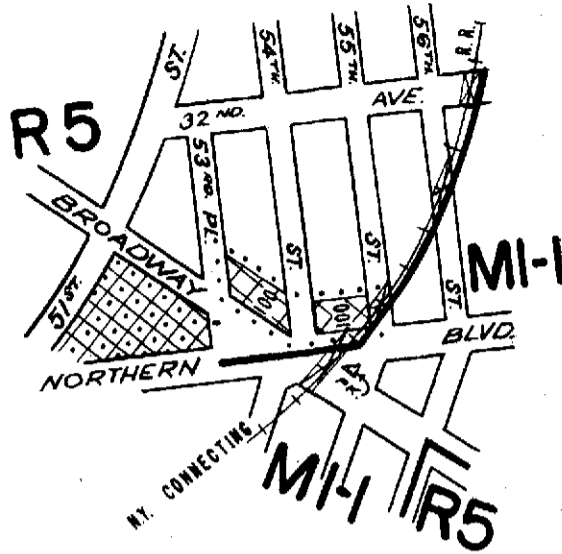

*Ver* *W*

**OKAP**

*VIS*

**CITY PLANNING COMMISSION  
CITY OF NEW YORK  
DIAGRAM SHOWING PROPOSED  
ZONING CHANGE  
ON SECTIONAL MAP**

9d

**BOROUGH OF  
QUEENS**

New York, September 30, 1964

*Samuel Steinberg*  
Secretary

*F. De Filippo, S.C.E.*  
Director, Division of Zoning

*J. F. Ashworth*  
Chief, Office of Technical Controls



**NOTE:**

- indicates Zoning District boundary.
- The area enclosed by the fine dotted line is proposed to be changed by the establishment of a C1-2 District within an existing R5 District.
- indicates a C1-2 District.
- indicates a C2-2 District.

R.C. ✓

A-509  
E.D. NOV. 19, 1964

30 day  
11/27/64

JK

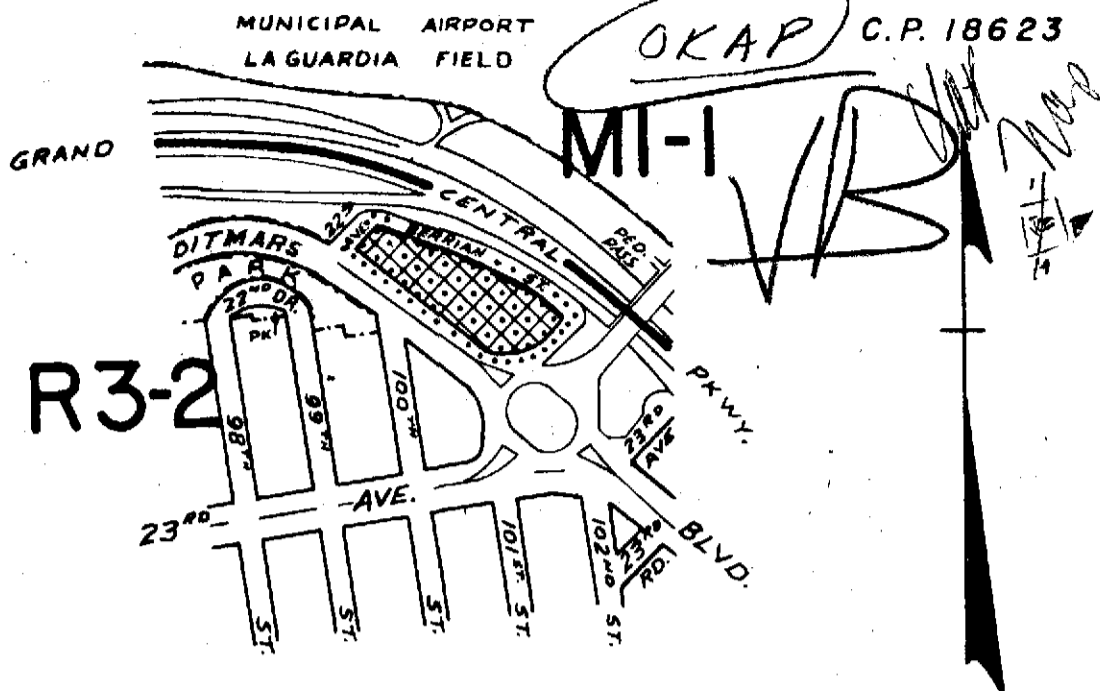

CITY PLANNING COMMISSION  
 CITY OF NEW YORK  
 DIAGRAM SHOWING PROPOSED  
 ZONING CHANGE  
 ON SECTIONAL MAP

9c  
 BOROUGH OF  
 QUEENS

New York, September 30, 1964

*Samuel Steinberg*  
 Secretary

*F. De Filippo*  
 Director, Division of Zoning

*J. F. Ashworth*  
 Chief, Office of Technical Controls

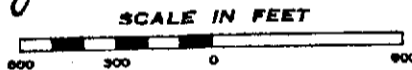

**NOTE:**

- indicates Zoning District boundary.
- The area enclosed by the fine dotted line is proposed to be changed by establishing a C2-2 District within an existing R3-2 District.
- indicates a C2-2 District.

N.A.P.

W

A-505

E. Date. Nov. 6, 64

30 day ends - 11/27/64

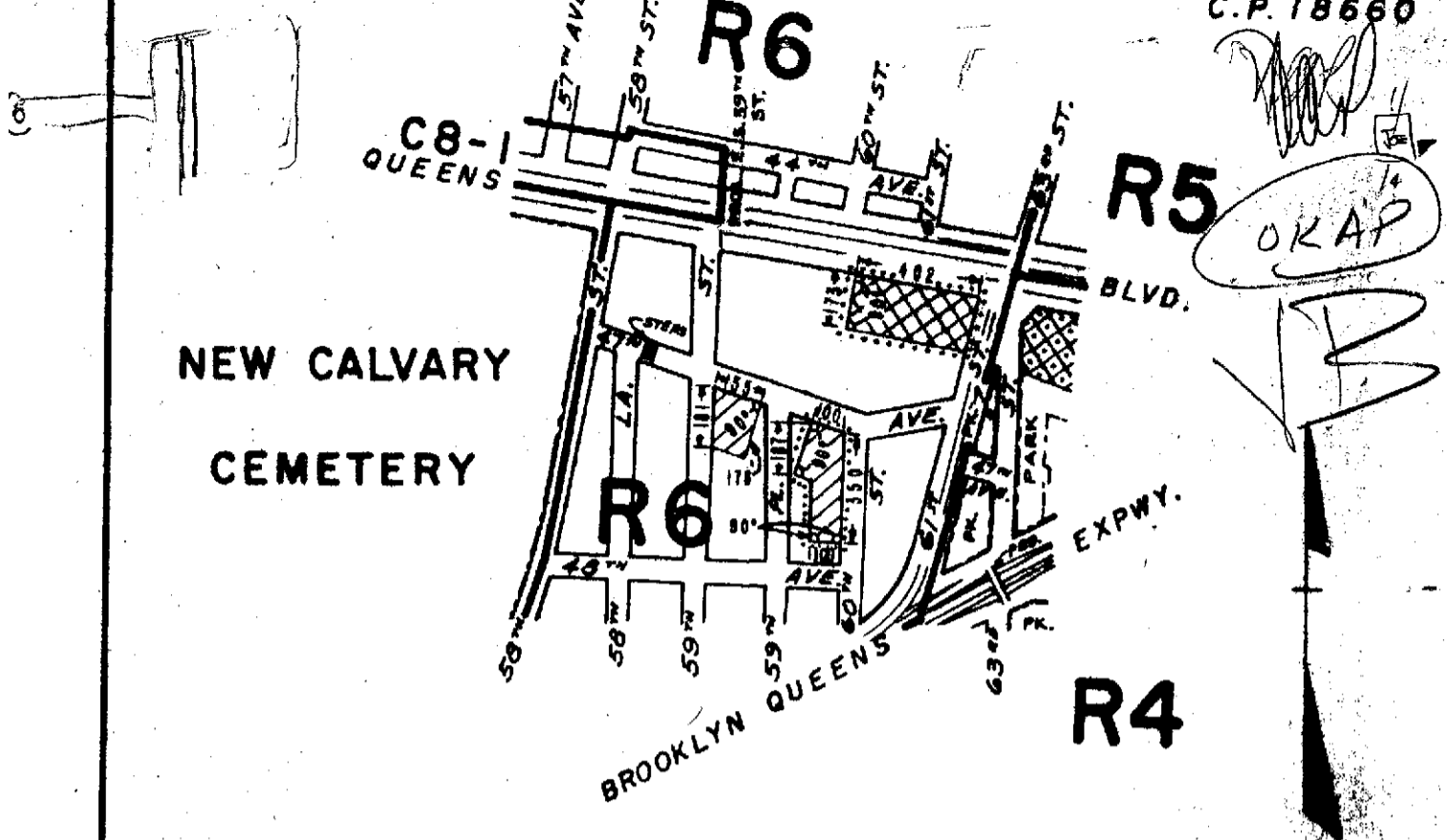

CITY PLANNING COMMISSION  
 CITY OF NEW YORK  
 DIAGRAM SHOWING PROPOSED  
 ZONING CHANGE  
 ON SECTIONAL MAP  
 9d

BOROUGH OF  
 QUEENS

New York, October 14, 1964

*Samuel Steinberg*

Secretary



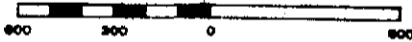

*Louise Roberts*  
 Acting Director, Division of Zoning

*J. F. Ashworth*  
 Chief, Office of Technical Controls

SCALE IN FEET



NOTE:

-  indicates Zoning District boundary.
-  The areas enclosed by the fine dotted line are proposed to be changed by establishing C1-1 and C1-2 Districts within an existing R6 District.
-  indicates a C1-1 District.
-  indicates a C1-2 District.
-  indicates a C2-2 District.

sr FC Sec. 1

30 day

12/12/69

A- 513

E.D. 11/19/69

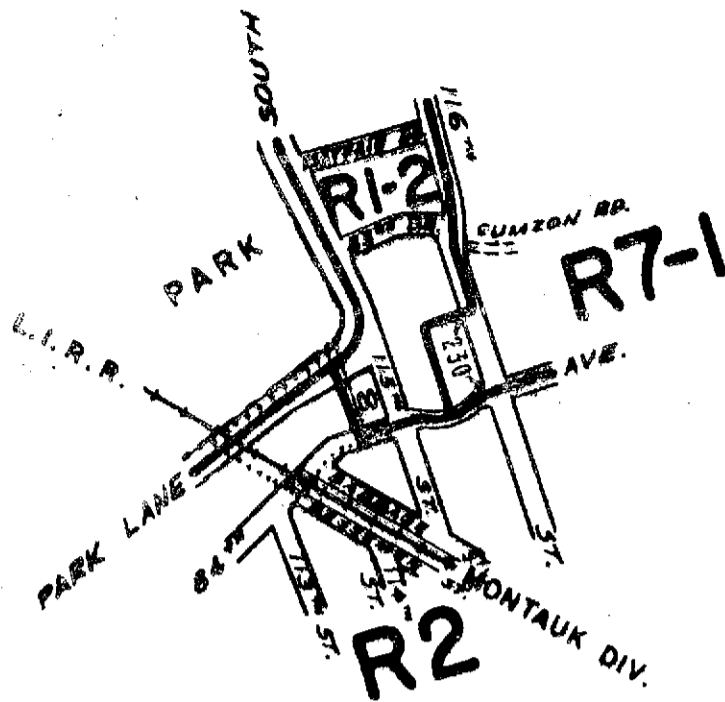

*[Handwritten signature]*  
 OKAR  
*[Handwritten signature]*

CITY PLANNING COMMISSION  
 CITY OF NEW YORK  
**DIAGRAM SHOWING PROPOSED  
 ZONING CHANGE  
 ON SECTIONAL MAP  
 14b**

BOROUGH OF  
 QUEENS

New York, October 28, 1964

*Benjamin Goldstein*  
 Acting Secretary

*F. DeLipio*  
 Director, Division of Zoning  
*J. F. Ashworth*  
 Chief, Office of Technical Controls

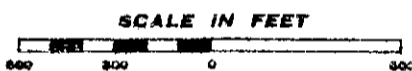

**NOTE:**

- indicates Zoning District boundary.
- ..... The area enclosed by the fine dotted line is proposed to be changed from an RI-2 District to an R2 District.

FC. 516 W

A- 518

30 day ends  
 12-25-64

E date  
 Jan-14, 1965

C. P. 18664

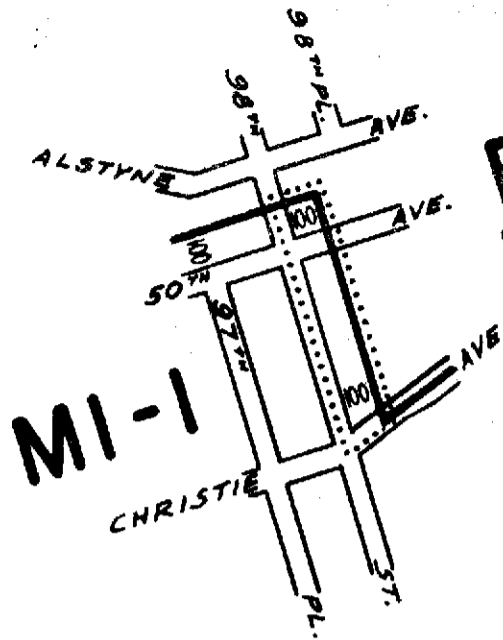

*Handwritten:* OKAP  
*Handwritten:* [Signature]  
*Handwritten:* [Large stylized signature]

**CITY PLANNING COMMISSION  
 CITY OF NEW YORK  
 DIAGRAM SHOWING PROPOSED  
 ZONING CHANGE  
 ON SECTIONAL MAP  
 10b**

**BOROUGH OF  
 QUEENS**

New York, October 28, 1964

*Handwritten:* Benjamin Goldstein  
 Acting Secretary

*Handwritten:* J. De Filippo & Co  
 Director, Division of Zoning  
*Handwritten:* J. F. Ashworth  
 Chief, Office of Technical Controls

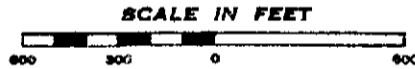

**NOTE:**

- - - - - indicates Zoning District boundary.
- ..... The area enclosed by the fine dotted line is proposed to be changed from an R6 District to an MI-1 District.

*Handwritten:* W sr F.C. 529

*Handwritten:* A - 529

*Handwritten:* (30 days ends Feb 20 65)

*Handwritten:* E.D. Jan 28, 65

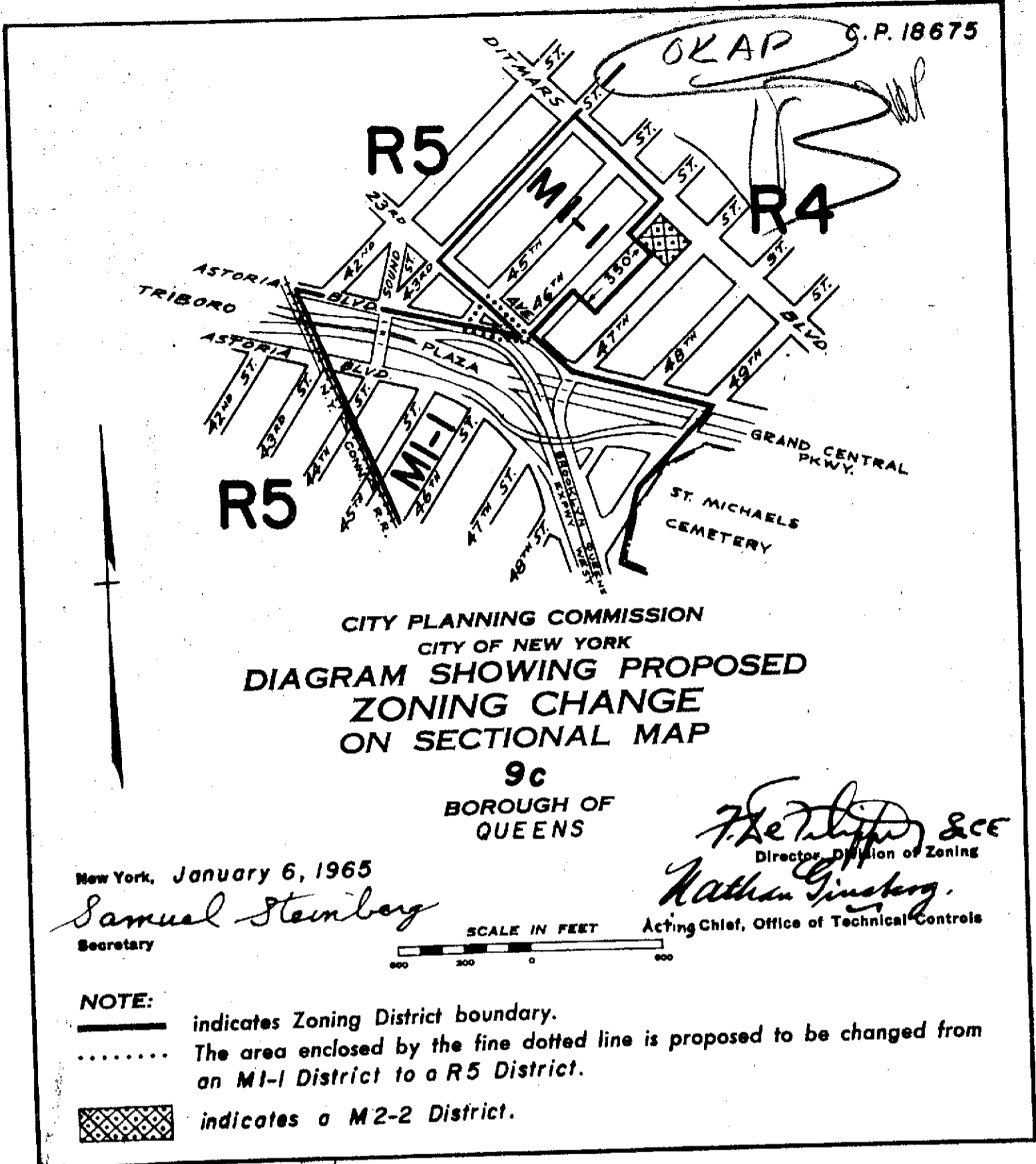

CITY PLANNING COMMISSION  
 CITY OF NEW YORK  
 DIAGRAM SHOWING PROPOSED  
 ZONING CHANGE  
 ON SECTIONAL MAP

9c  
 BOROUGH OF  
 QUEENS

New York, January 6, 1965

*Samuel Steinberg*  
 Secretary

*Frederick S. ...* & C.E.  
 Director, Division of Zoning  
*Nathan Ginsberg*  
 Acting Chief, Office of Technical Controls

- NOTE:**
- indicates Zoning District boundary.
  - ..... The area enclosed by the fine dotted line is proposed to be changed from an MI-1 District to a R5 District.
  - ▣ indicates a M2-2 District.

C.N. F.C. 565

A-534

Off. date *max*  
 feb. 11, 1965

30 day *or*  
 march 5, 65



*OKAD*

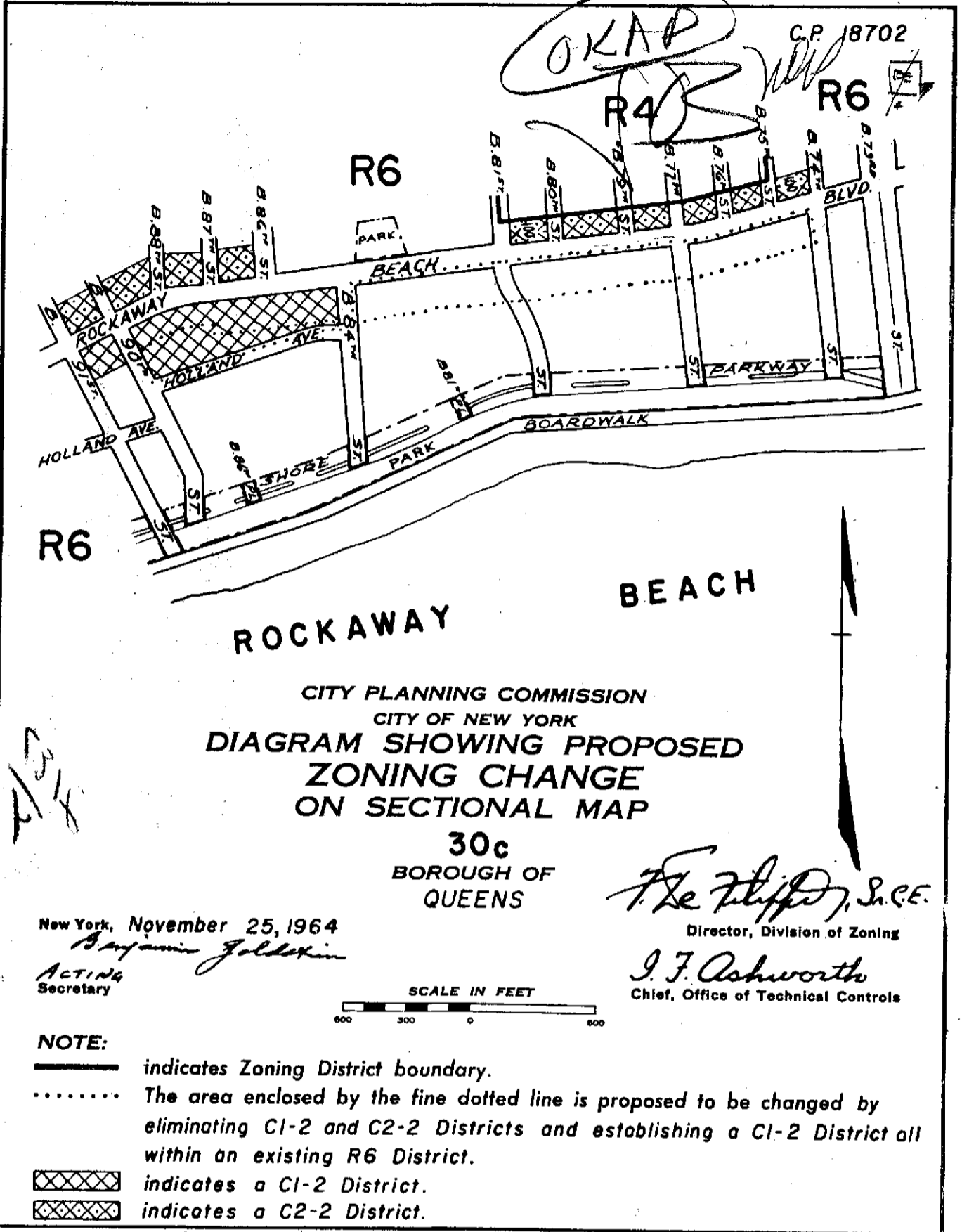

CITY PLANNING COMMISSION  
 CITY OF NEW YORK  
**DIAGRAM SHOWING PROPOSED ZONING CHANGE ON SECTIONAL MAP**

**30c**  
 BOROUGH OF QUEENS

*F. De Filippo, S.C.E.*  
 Director, Division of Zoning  
*J. F. Ashworth*  
 Chief, Office of Technical Controls

New York, November 25, 1964  
*Benjamin Goldstein*  
 ACTING Secretary



A.J.P. F.C. W

*A-523 ✓*  
*OK*

*(30 day ends 2-5-65)*

*E Date Jan 14, 1965 ✓*

*OKAP*

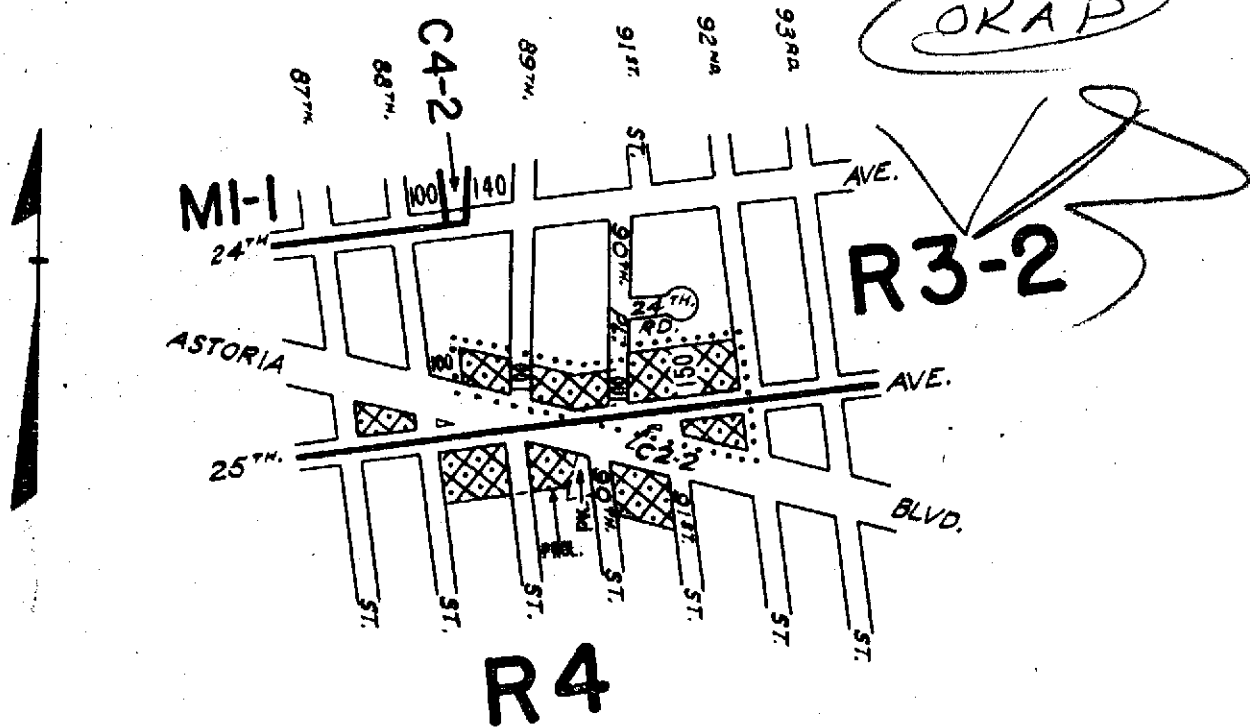

**CITY PLANNING COMMISSION  
CITY OF NEW YORK  
DIAGRAM SHOWING PROPOSED  
ZONING CHANGE  
ON SECTIONAL MAP**

9c

BOROUGH OF  
QUEENS

New York, December 9, 1964

*Samuel Steinberg*  
Secretary



*F. E. Ashworth, Jr.*  
Director, Division of Zoning

*J. F. Ashworth*  
Chief, Office of Technical Controls

SCALE IN FEET



**NOTE:**

-  indicates Zoning District boundary.
-  The area enclosed by the fine dotted line is proposed to be changed by establishing a C2-2 District within existing R3-2 and R4 Districts.
-  indicates a C2-2 District.

*J.B. F.C., etc.*

*Please Push*

*A-531*

*2/11/65*



*30 day  
2/20/65*

*OK*



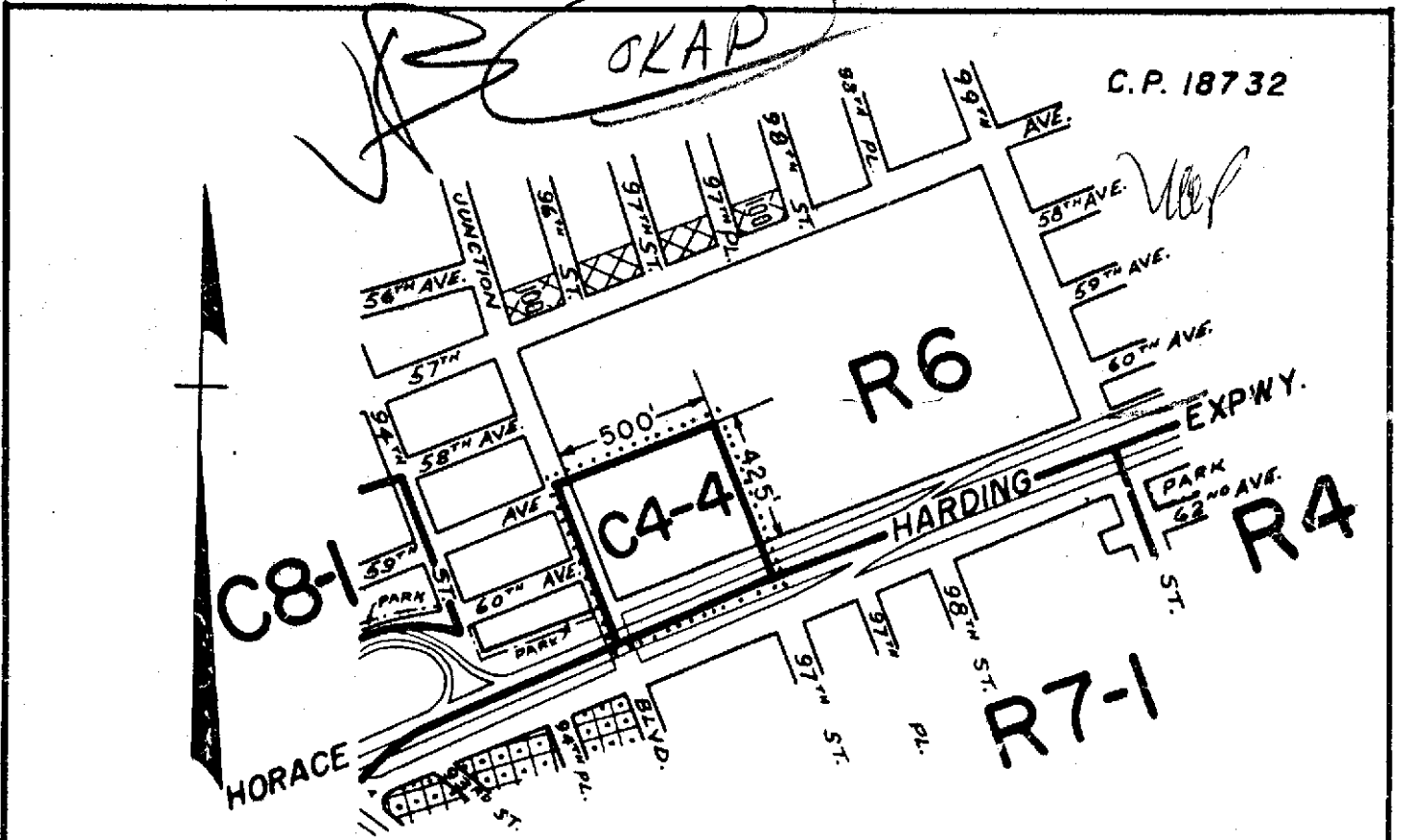

CITY PLANNING COMMISSION  
CITY OF NEW YORK  
**DIAGRAM SHOWING PROPOSED  
ZONING CHANGE  
ON SECTIONAL MAP**

**14a**

BOROUGH OF  
QUEENS

New York, December 18, 1964

*Benjamin Goldstein*

Acting  
Secretary

*Frederick S. ...*  
Director, Division of Zoning

*J. F. Ashworth*

Chief, Office of Technical Controls

SCALE IN FEET



**NOTE:**

- indicates Zoning District boundary.
- The area enclosed by the fine dotted line is proposed to be changed from an R6 District to a C4-4 District.
- indicates a C1-2 District.
- indicates a C2-2 District.

A-530V  
E.D. Jan 28 1965

(30 day ends)  
Feb. 20, 65

C.P. 18737

*OKAP*

R3-2

R3-2

C4-2

C4-2

MI-1

JOHN F. KENNEDY INTERNATIONAL AIRPORT

CITY PLANNING COMMISSION  
CITY OF NEW YORK  
DIAGRAM SHOWING PROPOSED  
ZONING CHANGE  
ON SECTIONAL MAP

18d  
BOROUGH OF QUEENS

New York, January 6, 1965

*Samuel Steinberg*  
Secretary

*F. De Filippo* & C.E.  
Director, Division of Zoning

*Nathan Grinstberg*  
Acting Chief, Office of Technical Controls

SCALE IN FEET



NOTE:

- indicates Zoning District boundary.
- .....** The area enclosed by the fine dotted line is proposed to be changed from an R3-2 District to a C4-2 District.

*J.B. F.C. M.P.*

*Rush*

*A-544*

*E.D. March 25, 65*

*30 day ends March 5, 65*

*OKAD*

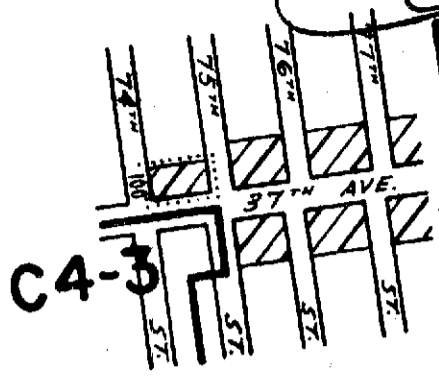

*map*

CITY PLANNING COMMISSION  
 CITY OF NEW YORK  
**DIAGRAM SHOWING PROPOSED  
 ZONING CHANGE  
 ON SECTIONAL MAP**

**9d**

**BOROUGH OF  
 QUEENS**

New York, January 20, 1965

*Samuel Steinberg*  
 Secretary

*F. DeFilippo*  
 Director, Division of Zoning

*J.F. Ashworth*  
 Chief, Office of Technical Controls



**NOTE:**

- indicates Zoning District boundary.
- The area enclosed by the fine dotted line is proposed to be changed by establishing a C1-3 District within an existing R7-1 District.
- indicates C1-3 District.

*14 8/4*

*A-542*

*4/3/65*

*March 11, 1965 29*

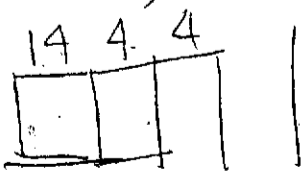

OKAP

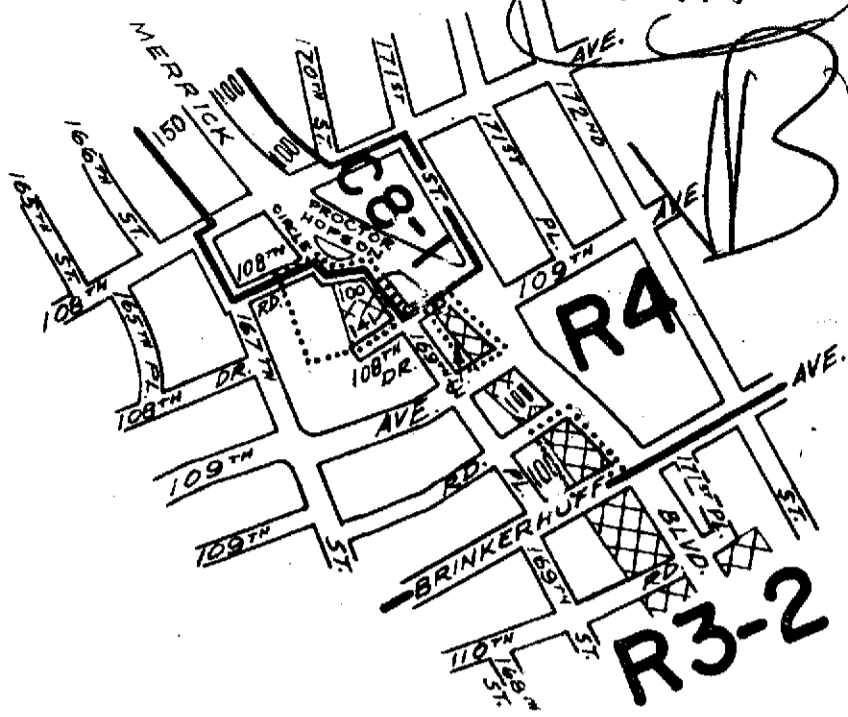

*Wagner*

CITY PLANNING COMMISSION  
CITY OF NEW YORK  
DIAGRAM SHOWING PROPOSED  
ZONING CHANGE  
ON SECTIONAL MAP

14d  
BOROUGH OF  
QUEENS

New York, January 20, 1965

*Samuel Steinberg*  
Secretary

*F. DeLapp*  
Director, Division of Zoning

*J.F. Ashworth*  
Chief, Office of Technical Controls



NOTE:

- indicates Zoning District boundary.
- The area enclosed by the fine dotted line is proposed to be changed from a CB-1 District to an R4 District and establishing CI-2 Districts within the proposed and existing R4 District.
- indicates a CI-2 District.

G.H.

A-543

*Ends 9, 3, 65*

*March 11, 1965*

*OK*

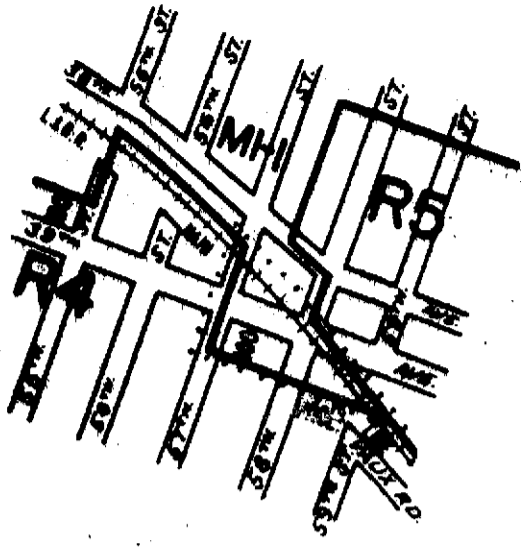

CITY PLANNING COMMISSION  
CITY OF NEW YORK  
DIAGRAM SHOWING PROPOSED  
ZONING CHANGE  
ON SECTIONAL MAP

9d  
BOROUGH OF  
QUEENS

New York, March 3, 1965

*Samuel Steinberg*  
Secretary

*F. Theophilus* S.C.E.  
Director, Division of Zoning

*J. F. Ashworth*  
Chief, Office of Technical Controls

SCALE IN FEET



**NOTE:**

- Indicates Zoning District boundary.
- The area enclosed by the fine dotted line is proposed to be changed from an R4 District to an M1-1 District.

R.C. FC DV

*Indefinite for review*

A-552

E. Date  
April 22, 65

Ends 5/1/65

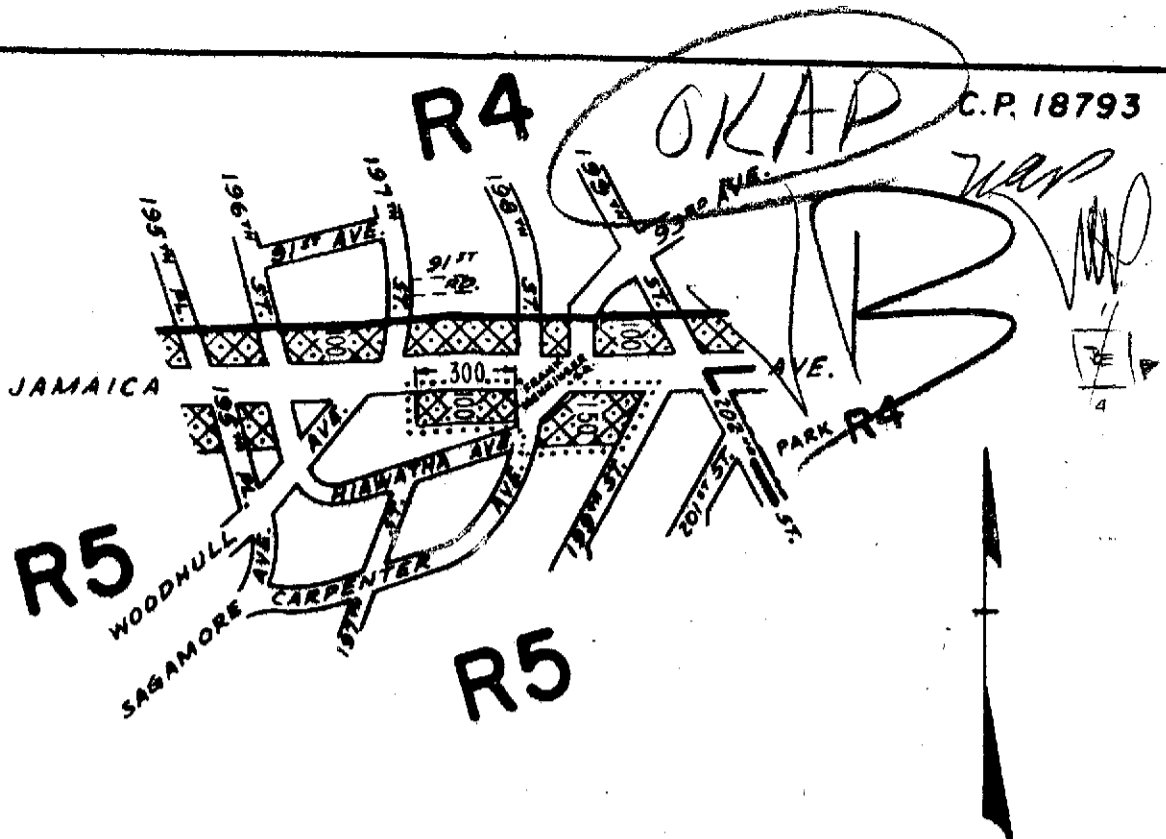

CITY PLANNING COMMISSION  
 CITY OF NEW YORK  
 DIAGRAM SHOWING PROPOSED  
 ZONING CHANGE  
 ON SECTIONAL MAP  
 15b

BOROUGH OF  
 QUEENS

New York, March 3, 1965

*Samuel Steinberg*  
 Secretary

*F. DeTilly, S.C.E.*  
 Director, Division of Zoning

*J. F. Ashworth*  
 Chief, Office of Technical Controls

SCALE IN FEET



NOTE:

- indicates Zoning District boundary.
- ..... The area enclosed by the fine dotted line is proposed to be changed by establishing a C2-2 District within an existing R5 District.
- ▣ indicates a C2-2 District.

Sr F.C. 1241

A-551 ✓

April 8, 65 ✓

ends  
 5, 1, 65

OK  
 J.T.

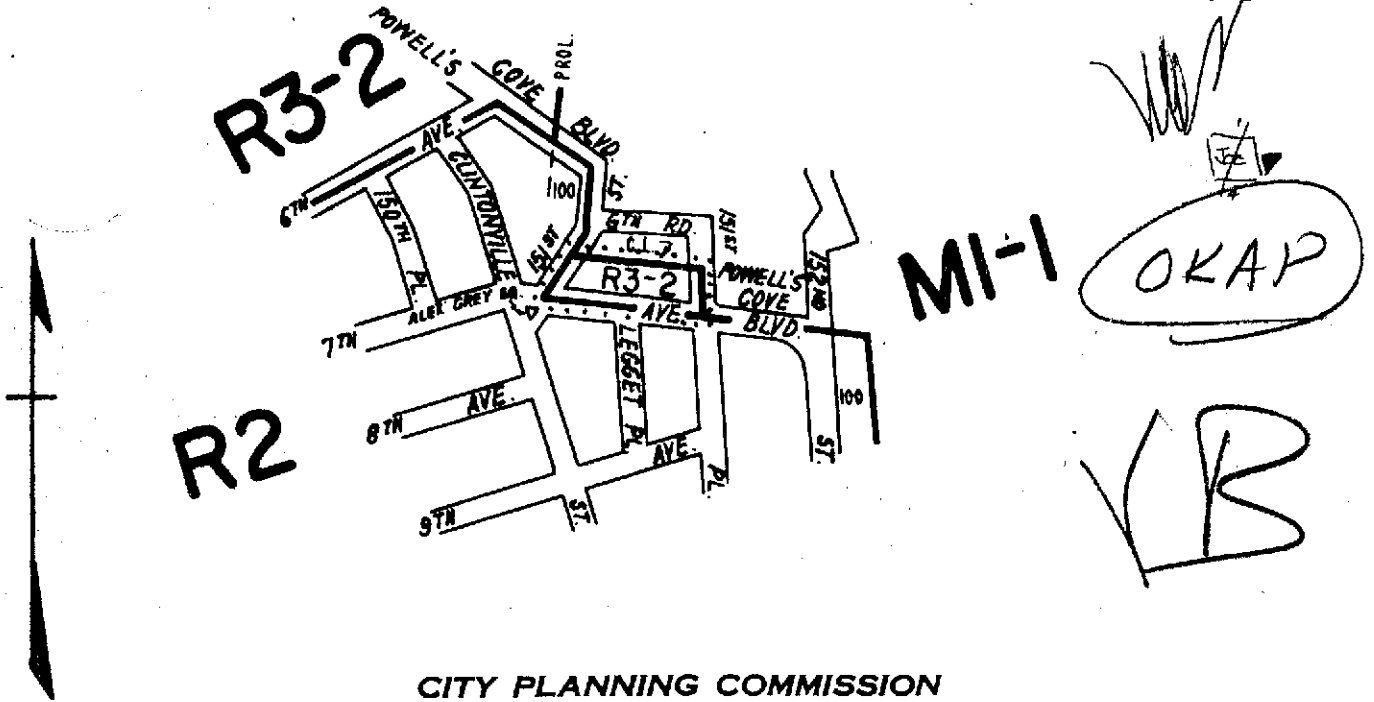

CITY PLANNING COMMISSION  
 CITY OF NEW YORK  
**DIAGRAM SHOWING PROPOSED  
 ZONING CHANGE  
 ON SECTIONAL MAP  
 -7d**

BOROUGH OF

Mod. by C.P.C. - May 12, 1965 (Cal. No. 29) QUEENS  
 New York, March 31, 1965

*F. DeFilippo, Jr. & Co.*  
 Director, Division of Zoning

*Samuel Steinberg*  
 Secretary

*J. F. Ashworth*  
 Chief, Office of Technical Controls



**NOTE:**

- indicates Zoning District boundary.
- .....** The area enclosed by the fine dotted line is proposed to be changed from an MI-1 District to an R3-2 District.

A-556

OK

May 20, 65

6/12/65

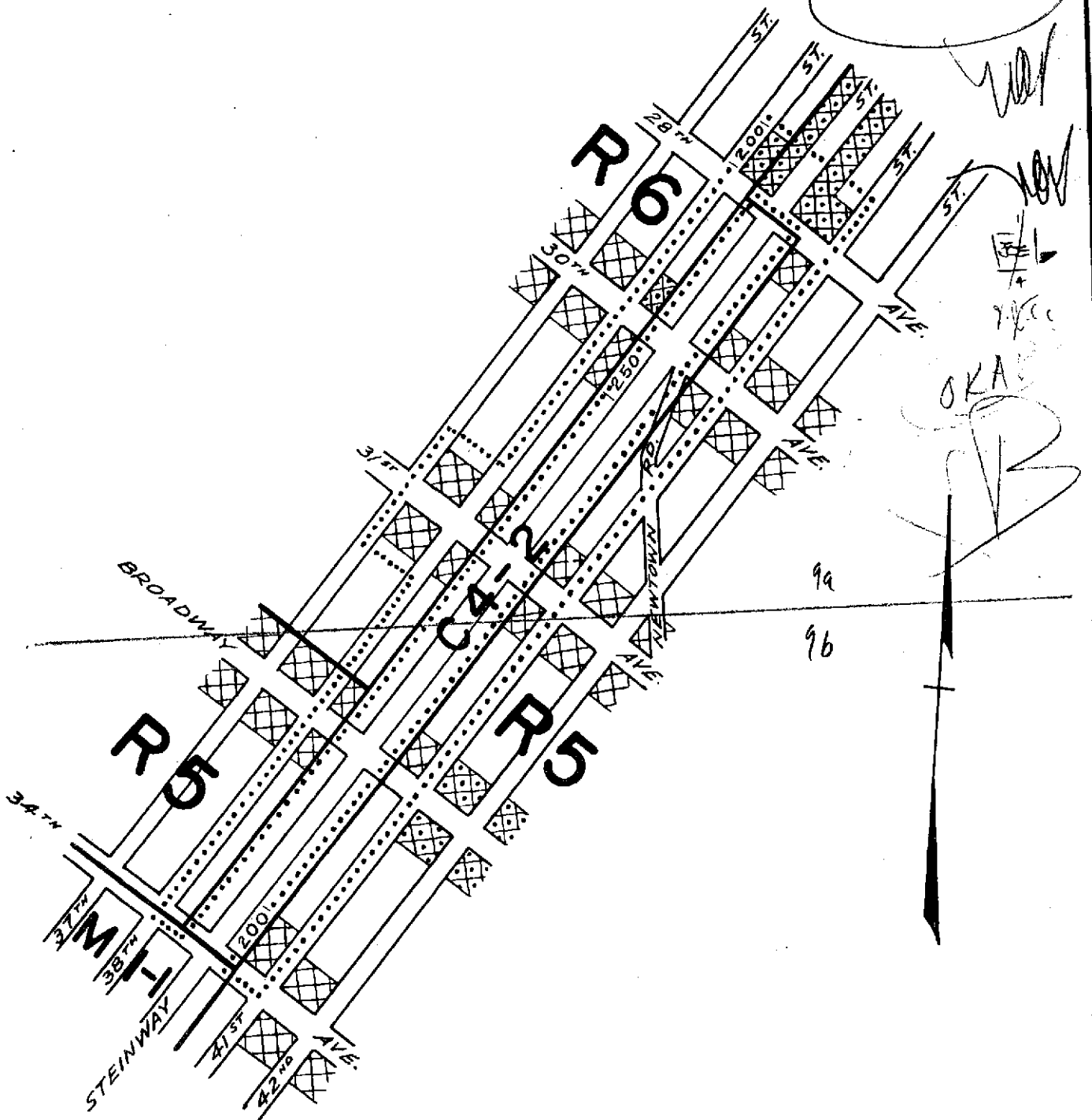

CITY PLANNING COMMISSION  
 CITY OF NEW YORK  
**DIAGRAM SHOWING PROPOSED  
 ZONING CHANGE  
 ON SECTIONAL MAPS  
 9a & 9b**  
 BOROUGH OF  
 QUEENS

New York, April 14, 1965

*Samuel Steinberg*  
 Secretary



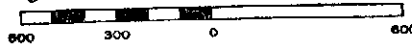

*F. De Filippo, & Co.*  
 Director, Division of Zoning

*J. F. Ashworth*  
 Chief, Office of Technical Controls

SCALE IN FEET



**NOTE:**

-  indicates Zoning District boundary.
-  The area enclosed by the fine dotted line is proposed to be changed from a C4-2 District to R5 and R6 Districts, and establishing within the proposed R5 and R6 Districts, C1-2 and C2-2 Districts.
-  indicates a C1-2 District.
-  indicates a C2-2 District.

C.H.

A-574  
 June 24, 65

July 2, 65



C. P. 18940

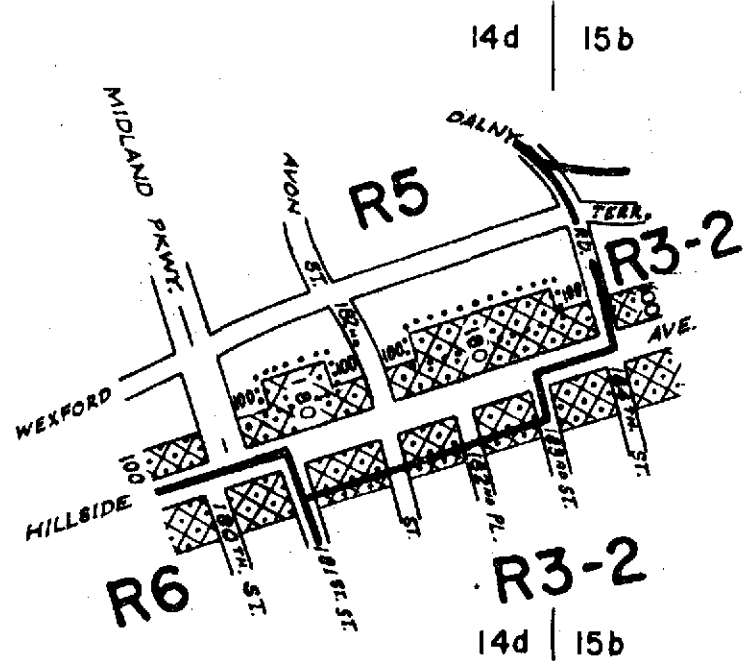

*Wally*  
  
 OKAP

CITY PLANNING COMMISSION  
 CITY OF NEW YORK  
**DIAGRAM SHOWING PROPOSED  
 ZONING CHANGE  
 ON SECTIONAL MAPS  
 14d & 15b**

BOROUGH OF  
 QUEENS

Modified C.P.C July 14, 1965 (Cal. No. 22)  
 New York, June 2, 1965

*Samuel Steinberg*  
 Secretary

*F. de Filippo*  
 Director, Division of Zoning  
*J. F. Ashworth*  
 Chief, Office of Technical Controls



- NOTE:**
- indicates Zoning District boundary.
  - The area enclosed by the fine dotted line is proposed to be changed by establishing a C2-2 District within an existing R5 District.
  - indicates a C2-2 District.

J.B. F.C. VRB

A-587

*ends.*  
 Aug 14 65  
 /

July 22, 1965

OK

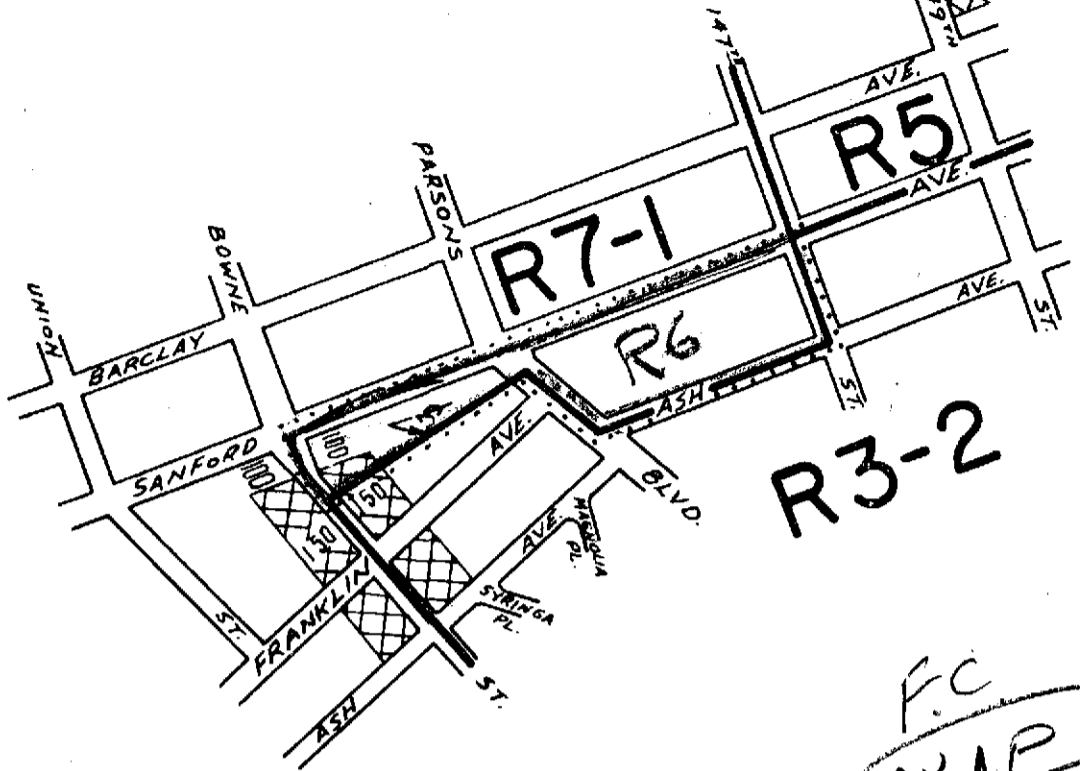

F.C.  
OKAP  
*[Handwritten signature]*

CITY PLANNING COMMISSION  
CITY OF NEW YORK  
DIAGRAM SHOWING PROPOSED  
ZONING CHANGE  
ON SECTIONAL MAP  
10d

BOROUGH OF  
QUEENS

Mod. by Bd. of Est. Oct 14, 1965 (Lal No 37)  
New York, July 14, 1965

*Samuel Steinberg*  
Secretary

*F. De Filippo*  
Director, Division of Zoning  
*J. F. Ashworth*  
Chief, Office of Technical Controls

SCALE IN FEET



NOTE:

- indicates Zoning District boundary.
- The area enclosed by the fine dotted line is proposed to be changed from an R3-2 District to an ~~R3-2~~ District.
- indicates a C1-2 District.

N.A.P.

**MODIFICATION**

A-597

Oct 14 1965

end Oct 16, 65

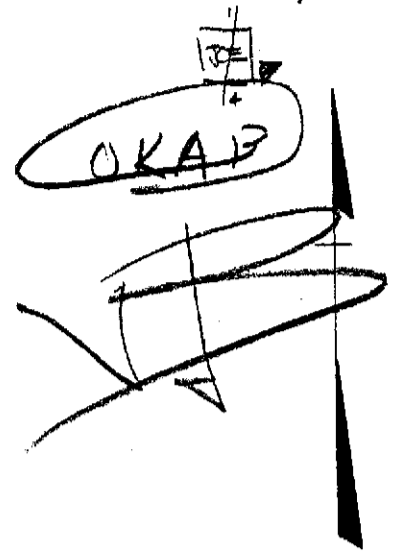
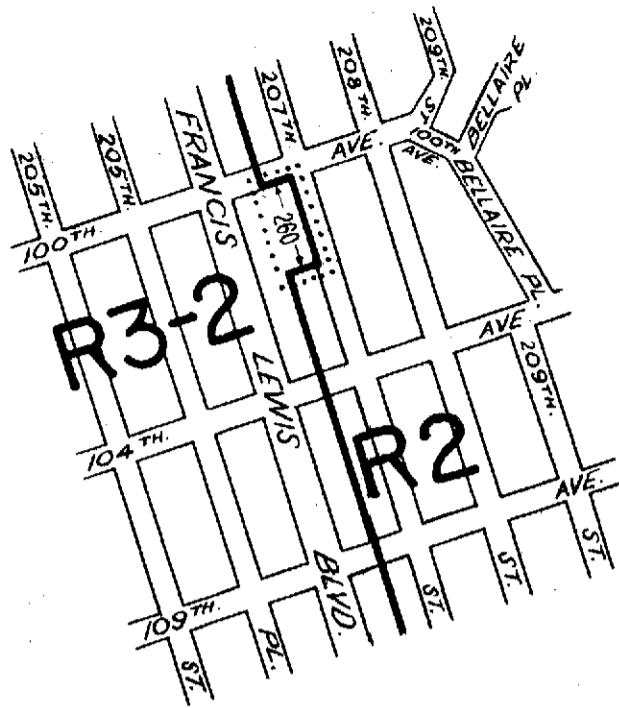

CITY PLANNING COMMISSION  
 CITY OF NEW YORK  
 DIAGRAM SHOWING PROPOSED  
 ZONING CHANGE  
 ON SECTIONAL MAP

15b

BOROUGH OF  
 QUEENS

New York, Sept. 15, 1965

Secretary

*Samuel Stenberg*

SCALE IN FEET

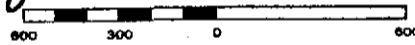

NOTE:

- indicates Zoning District boundary.
- ..... The area enclosed by the fine dotted line is proposed to be changed from an R2 District to an R3-2 District.

*F. De Filippo*  
 Director, Division of Zoning

*J.F. Ashworth*  
 Chief, Office of Technical Controls

RC. 100

A-607      @ 2865

OR ends      11/19/65

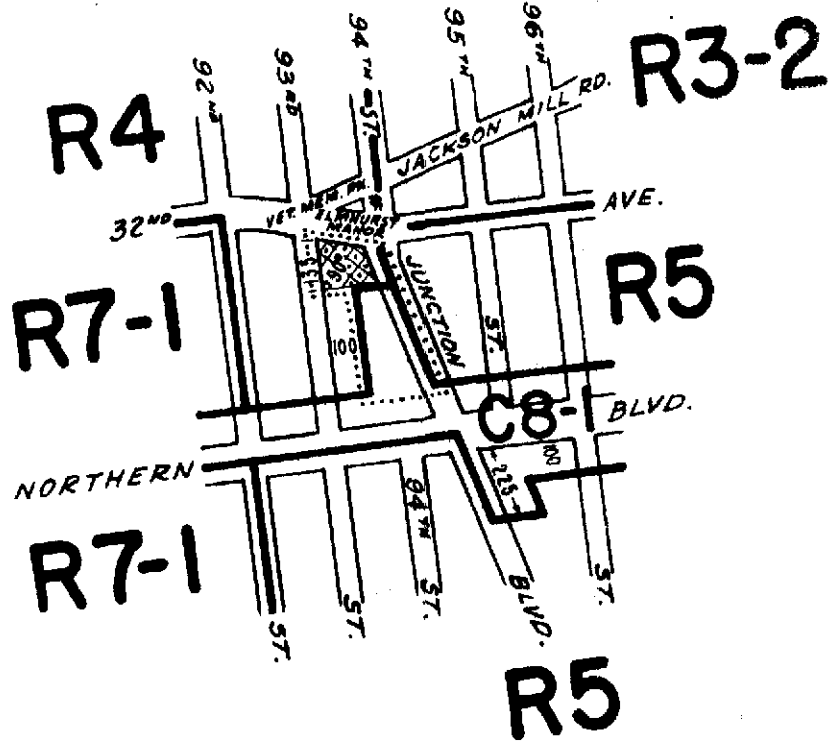

*WV*  
 1  
 4  
 OKAP  
 JB

CITY PLANNING COMMISSION  
 CITY OF NEW YORK  
 DIAGRAM SHOWING PROPOSED  
 ZONING CHANGE  
 ON SECTIONAL MAP  
 9d

BOROUGH OF  
 QUEENS

New York, September 15, 1965

*Samuel Steinberg*  
 Secretary

*F. De Filippo*  
 Director, Division of Zoning

*J. F. Ashworth*  
 Chief, Office of Technical Controls



NOTE:

- indicates Zoning District boundary.
- .....** The area enclosed by the fine dotted line is proposed to be changed from an R4 District to a C8-1 District and establishing a C2-2 District within an existing R4 District.
- ▨** indicates a C2-2 District.

sr

BR

*Finished*

A-608

E.D. Nov. 18, 65

End Nov 19 65

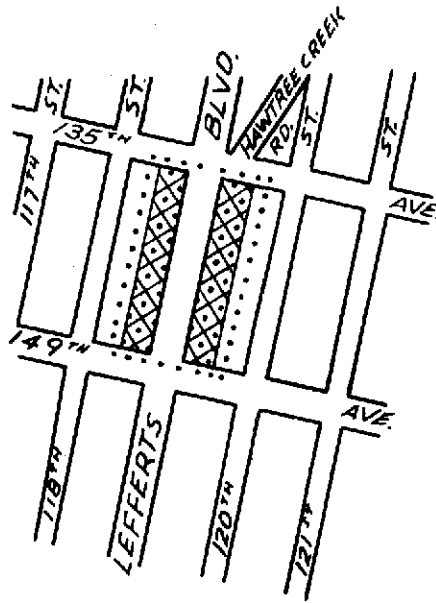

R3-2

*[Handwritten signatures and initials]*  
OKAP  
FC  
OK

CITY PLANNING COMMISSION  
CITY OF NEW YORK  
DIAGRAM SHOWING PROPOSED  
ZONING CHANGE  
ON SECTIONAL MAP

18d  
BOROUGH OF  
QUEENS

New York, October 20, 1965  
*Benjamin Goldstein*  
ACTING  
Secretary

*F. De Filippo*  
Director, Division of Zoning

*J. F. Ashworth*  
Chief, Office of Technical Controls



NOTE:

- indicates Zoning District boundary.
- The area enclosed by the fine dotted line is proposed to be changed by eliminating a C1-2 District and establishing C2-2 District within an existing R3-2 District.
- indicates an C2-2 District.

OK Rush

A-625  
Jan 13, 66

ends Dec 24 -

C.P. 19096

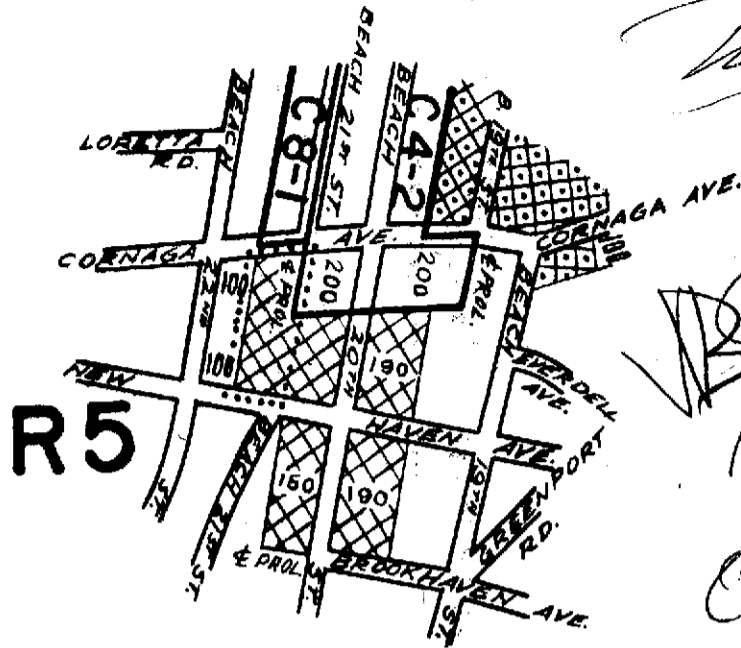

OKAP  
 FC  
 OK

CITY PLANNING COMMISSION  
 CITY OF NEW YORK  
**DIAGRAM SHOWING PROPOSED  
 ZONING CHANGE  
 ON SECTIONAL MAP  
 31a**  
 BOROUGH OF  
 QUEENS

New York, October 20, 1965  
*Reginald Goldstein*  
 Acting  
 Secretary

*F. DeFilippis*  
 Director, Division of Zoning  
*J. F. Ashworth*  
 Chief, Office of Technical Controls



**NOTE:**

- indicates Zoning District boundary.
- The area enclosed by the fine dotted line is proposed to be changed by establishing a C1-2 District within an existing R5 District.
- indicates a C1-2 District.
- indicates a C2-2 District.

G.M. F.C. S.C.S.

*Push.*

A-626  
 626

*ends 12/24/65*

*Jan 13, 66*

T

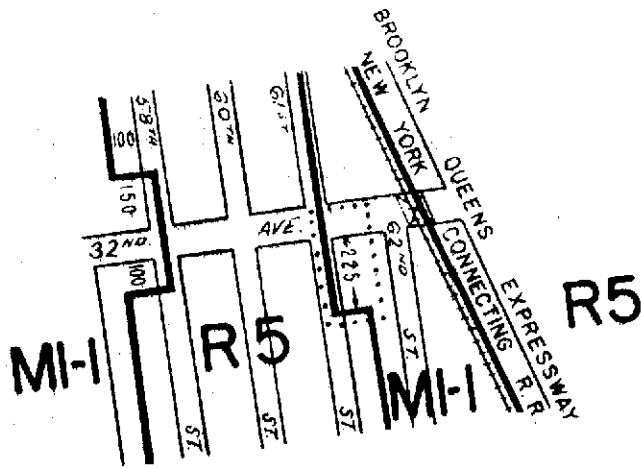

*[Handwritten signature]*  
 OKAP  
 JB

CITY PLANNING COMMISSION  
 CITY OF NEW YORK  
 DIAGRAM SHOWING PROPOSED  
 ZONING CHANGE  
 ON SECTIONAL MAP

9 d  
 BOROUGH OF  
 QUEENS

New York, October 5, 1965

*Samuel Steinberg*  
 Secretary

*F. De Felippis*  
 Director, Division of Zoning

*J. F. Ashworth*  
 Chief, Office of Technical Controls



NOTE:

- indicates Zoning District boundary.
- ..... The area enclosed by the fine dotted line is proposed to be changed from an R5 District to an MI-1 District.

R.C.

A-614

E.D. Nov. 18, 65

OK

End Dec. 10, 65

*Fenced*

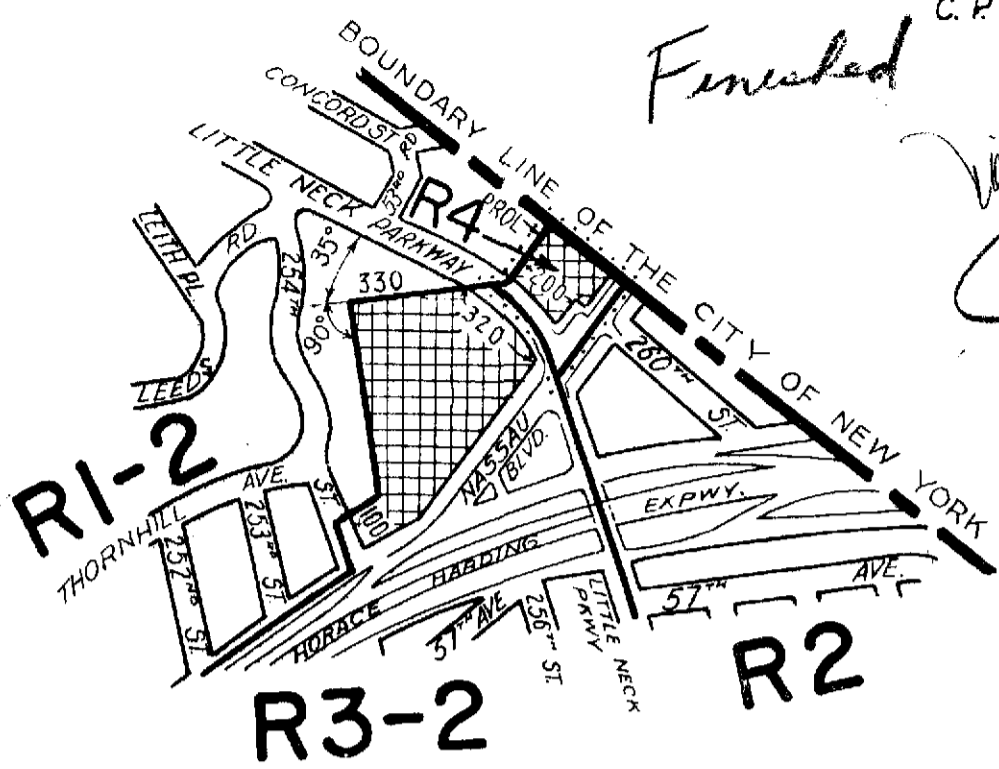

CITY PLANNING COMMISSION  
 CITY OF NEW YORK  
**DIAGRAM SHOWING PROPOSED  
 ZONING CHANGE  
 ON SECTIONAL MAP**

**11c**  
 BOROUGH OF  
 QUEENS

New York, October 5, 1965

*Samuel Steinberg*  
 Secretary

*F. De Filippo*  
 Director, Division of Zoning

*J. F. Ashworth*  
 Chief, Office of Technical Controls



- NOTE:**
- indicates Zoning District boundary.
  - The area enclosed by the fine dotted line is proposed to be changed from an R3-2 District to an R4 District.
  - indicates a C1-2 District.

*CSM*      *FR RR*

*A-615*

*ende - 12-10-65*

*E.D. 12/2/65*

*Push*



C. P. 1910!

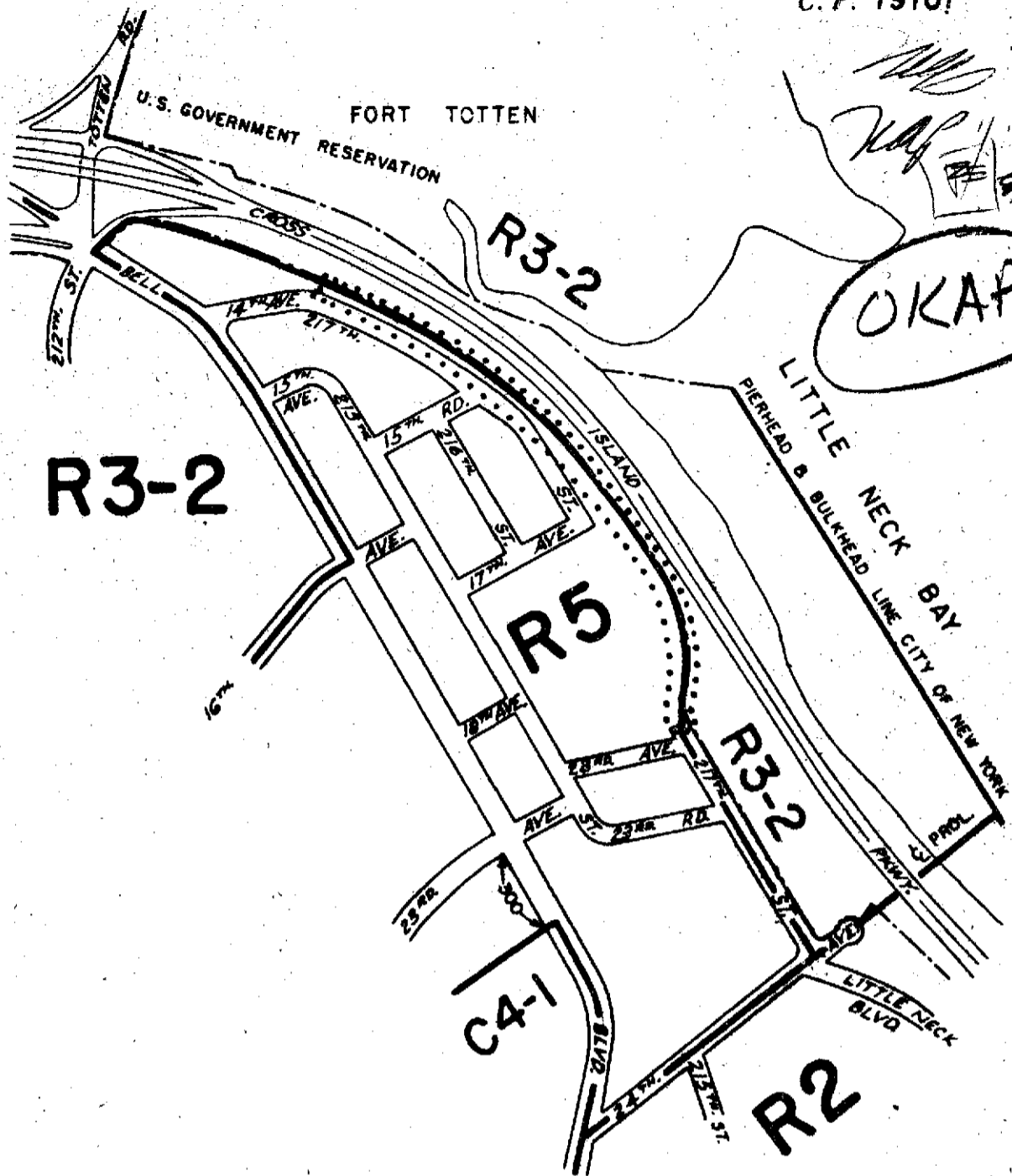

CITY PLANNING COMMISSION  
 CITY OF NEW YORK  
**DIAGRAM SHOWING PROPOSED  
 ZONING CHANGE  
 ON SECTIONAL MAPS  
 7d & 11c  
 BOROUGH OF  
 QUEENS**

New York, July 20, 1966

*John A. Vetrutti*  
 Secretary

*Louie Roberts*  
 Act. Director, Division of Zoning  
*J.F. Ashworth*  
 Chief, Office of Technical Controls

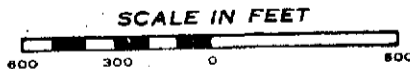

**NOTE:**

- indicates Zoning District boundary
- ..... The area enclosed by the fine dotted line is proposed to be changed from an R3-2 District to an R5 District.

A-689 *Push*

JR

Sept 22, 66

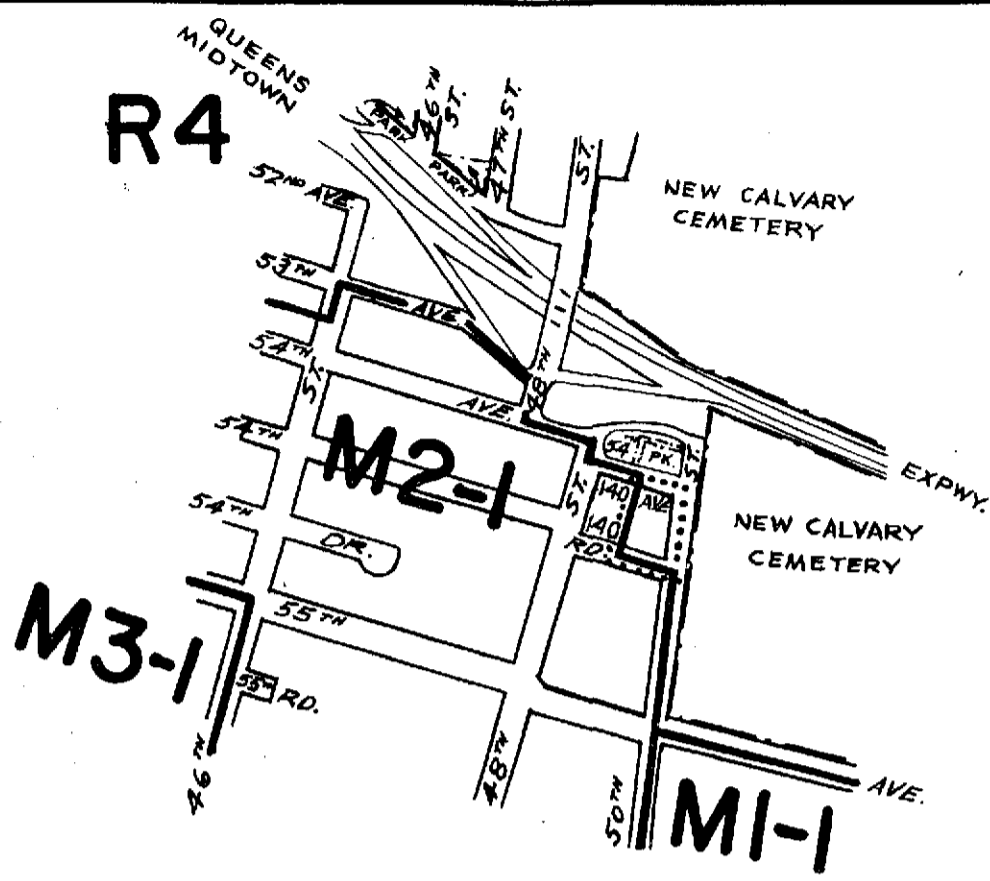

*W.P.*

*W.P.*

*121*

**OKAP**

CITY PLANNING COMMISSION  
 CITY OF NEW YORK  
**DIAGRAM SHOWING PROPOSED  
 ZONING CHANGE  
 ON SECTIONAL MAP**

**13a**  
 BOROUGH OF  
 QUEENS

New York, November 10, 1965

*Samuel Steinberg*  
 Secretary

*F. De Luff*  
 Director, Division of Zoning

*J. F. Ashworth*  
 Chief, Office of Technical Controls



- NOTE:**
- indicates Zoning District boundary.
  - .....** The area enclosed by the fine dotted line is proposed to be changed from an M2-1 District to an R4 District.

C.H.

F.C.

145

A-624

E.D. 12/16/65

E. nds 1/7/66

*FCM*  
*[Handwritten signature]*

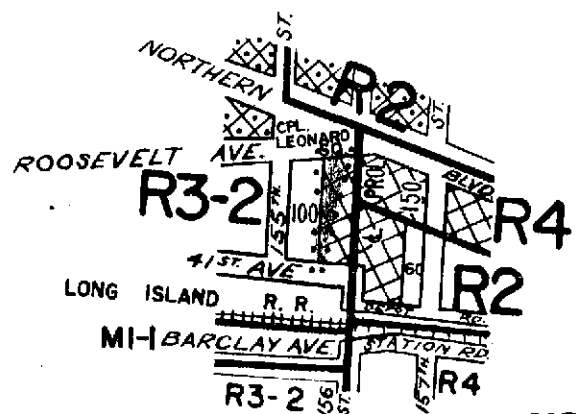

CITY PLANNING COMMISSION  
CITY OF NEW YORK  
**DIAGRAM SHOWING PROPOSED  
ZONING CHANGE  
ON SECTIONAL MAP**

10 c  
BOROUGH OF  
QUEENS

*F. De Filippo*  
Director, Division of Zoning  
*J. F. Ashworth*  
Chief, Office of Technical Controls

New York, November 24, 1965.  
*Benjamin Goldstein*  
ACTING  
Secretary

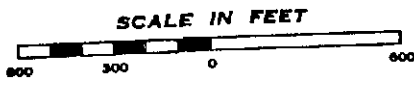

- NOTE:**
- indicates Zoning District boundary.
  - The area enclosed by the fine dotted line is proposed to be changed by establishing a C1-2 District within an existing R3-2 District.
  - indicates a C1-2 District.
  - indicates a C2-2 District.

R.C. F.C. P.P.

A-737

March 16, 1967

Rush. F.C.  
O.K.

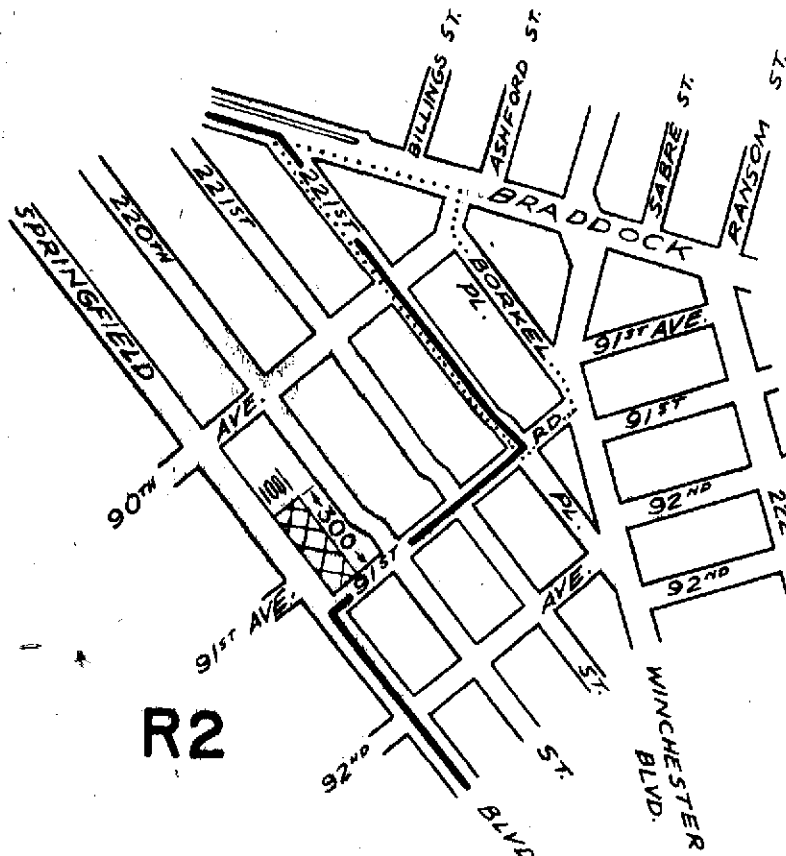

R3-2

OKAP

*[Handwritten scribble]*

R2

CITY PLANNING COMMISSION  
 CITY OF NEW YORK  
**DIAGRAM SHOWING PROPOSED  
 ZONING CHANGE  
 ON SECTIONAL MAP**

15a

BOROUGH OF  
QUEENS

New York, December 7, 1965

*Samuel Steinberg*  
 Secretary



*F. De Filippo*  
 Director, Div. of Zoning

*Walter Ginsberg*  
 Acting Chief, Office of Technical Controls

SCALE IN FEET



**NOTE:**

-  indicates Zoning District boundary.
-  The area enclosed by the fine dotted line is proposed to be changed from an R2 District to an R3-2 District.
-  indicates a C1-2 District.

C.H.

*cm FC*

*or*

*Push.*

A-643

E.D. 2/10/66

ends 2/4/66

*K.C.*

*1*

*MM*

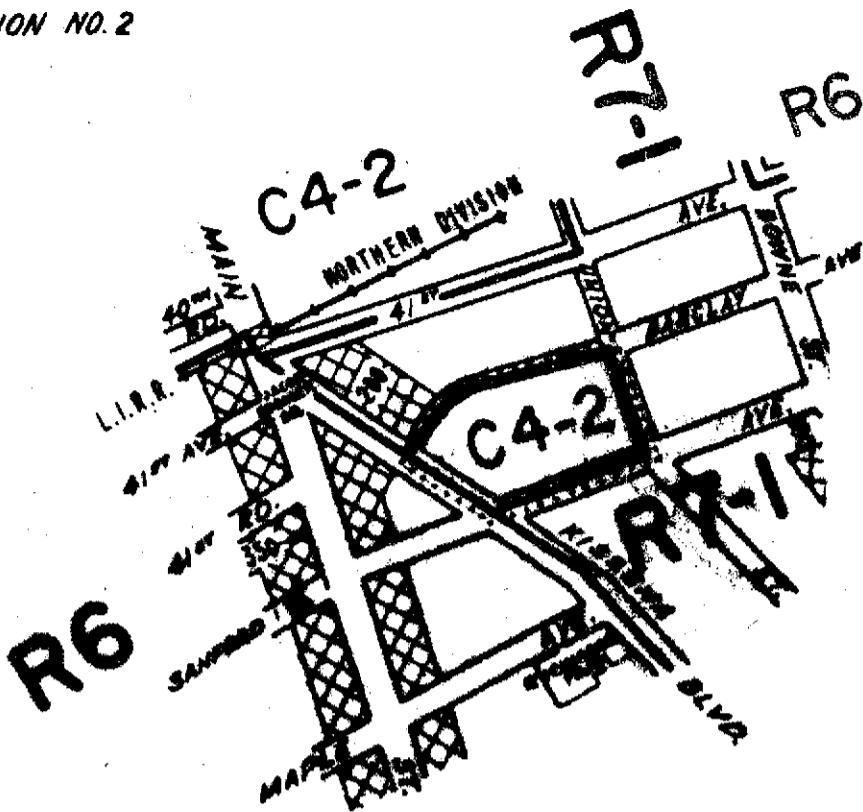

CITY PLANNING COMMISSION  
 CITY OF NEW YORK  
**DIAGRAM SHOWING PROPOSED  
 ZONING CHANGE  
 ON SECTIONAL MAP  
 10b**

BOROUGH OF QUEENS



New York, March 30, 1966

*John A. Viteritti*  
 Secretary

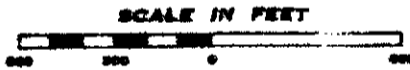
*Louis Roberts*  
 Asst. Director, Division of Zoning  
*J.F. Ashworth*  
 Chief, Office of Technical Controls



**NOTE:**

-  indicates Zoning District boundary.
-  The area enclosed by the fine dotted line is proposed to be changed from an R7-1 District to a C4-2 District.
-  Indicates a C1-2 District.

sr PL 10b

A-765 July 27, 67

ends. Aug 19, 67

1-

FC  
N.P.

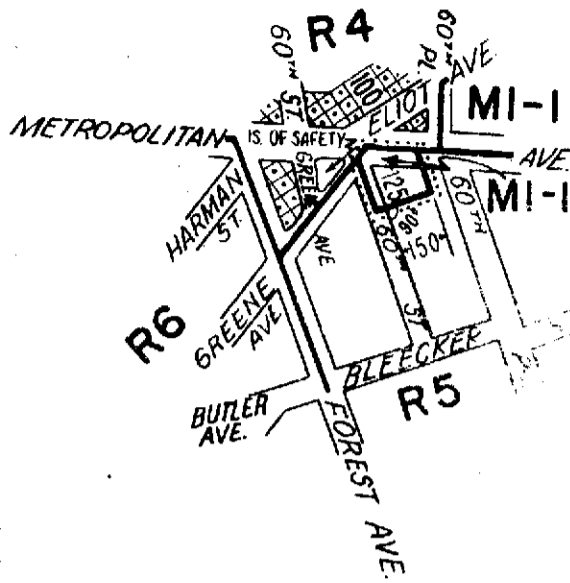

*WLP*

*OKAD*

*JB*



CITY PLANNING COMMISSION  
 CITY OF NEW YORK  
**DIAGRAM SHOWING PROPOSED  
 ZONING CHANGE  
 ON SECTIONAL MAP**

13d

BOROUGH OF  
QUEENS

New York, June 15, 1966

*John A. Vitentini*  
 Secretary

*Louis Roberti*  
 Actg. Director, Division of Zoning

*J. F. Ashworth*  
 Chief, Office of Technical Controls

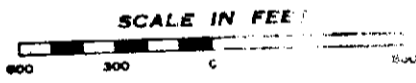

**NOTE:**

- indicates Zoning District boundary.
- The area enclosed by the fine dotted line is proposed to be changed from an R5 District to an MI-1 District.
- indicates a C2-2 District.

*CSM FC, VRB*

*A-686*

*OK.*  
*FC*  
*V.T.*

*Aug 25, 66*

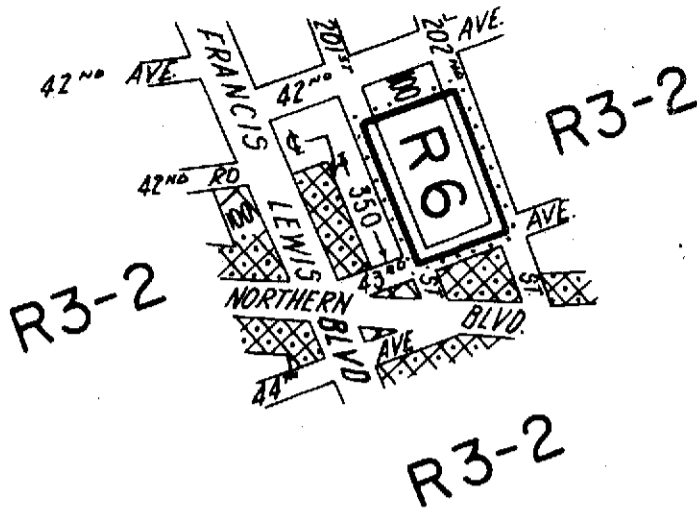

*Handwritten notes:*  
 OKAP  
 VB

CITY PLANNING COMMISSION  
 CITY OF NEW YORK  
**DIAGRAM SHOWING PROPOSED  
 ZONING CHANGE  
 ON SECTIONAL MAP  
 10d  
 BOROUGH OF  
 QUEENS**

New York, June 15, 1966

*John A. Vitentia*  
 Secretary

*Salvo Lewicki*  
 Acting Director, Division of Zoning  
*J. F. Ashworth*  
 Chief, Office of Technical Controls

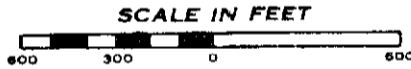

- NOTE:**
- indicates Zoning District boundary.
  - The area enclosed by the fine dotted line is proposed to be changed from an R3-2 District to an R6 District.
  - indicates a C2-2 District.

*CSM*

*Handwritten notes:*  
 OK  
 F.C.  
 V.T.  
 A-687  
 Aug 25, 66

C.P. 19451

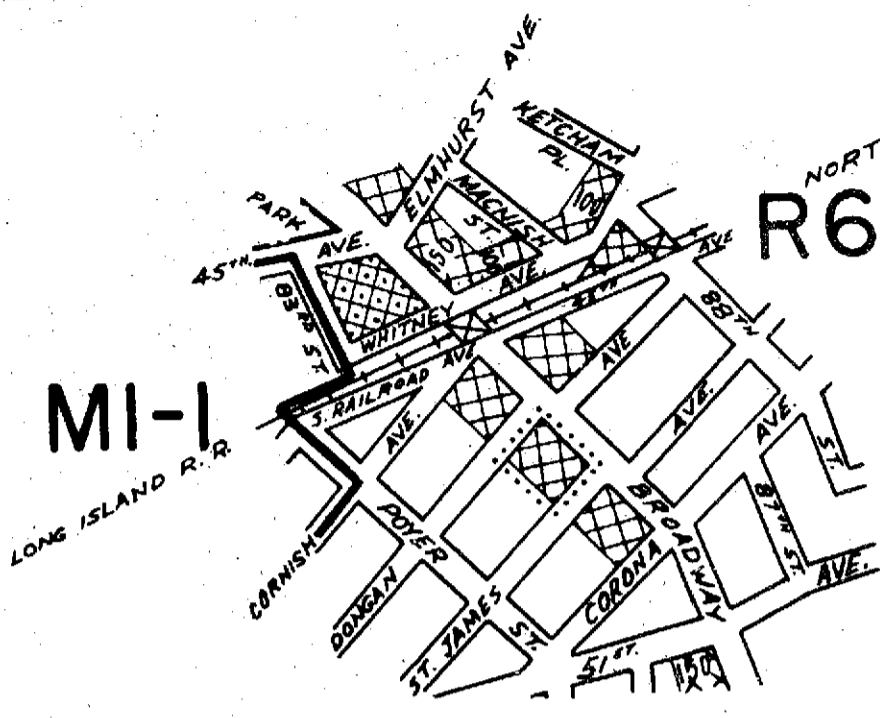

MI-1  
LONG ISLAND R.R.

CITY PLANNING COMMISSION  
CITY OF NEW YORK  
DIAGRAM SHOWING PROPOSED  
ZONING CHANGE  
ON SECTIONAL MAP





9d  
BOROUGH OF  
QUEENS

New York, July 20, 1966

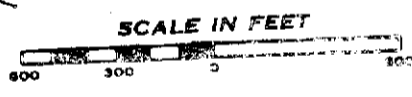
*John A. Viteritti*  
Secretary

*John P. ...*  
Acting Director, Division of Zoning  
*J. F. Ashworth*  
Chief, Office of Technical Controls



- NOTE:**
-  indicates Zoning District boundary.
  -  The area enclosed by the fine dotted line is proposed to be changed by establishing a CI-2 District within an existing R6 District.
  -  indicates a CI-2 District.
  -  indicates a C2-2 District.

N.A.P. 197

X-690

ED. Sept 22, 66

Rush



-44-

C.P. 19566

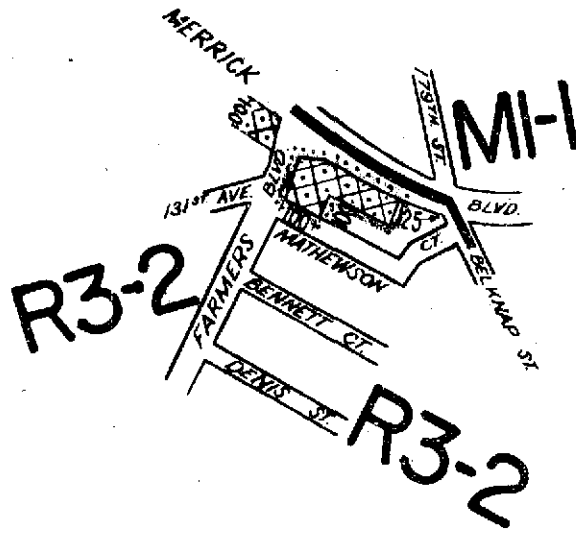

CITY PLANNING COMMISSION  
 CITY OF NEW YORK  
**DIAGRAM SHOWING PROPOSED  
 ZONING CHANGE  
 ON SECTIONAL MAP**

19 a  
 BOROUGH OF  
 QUEENS

New York, October 19, 1966

*John A. Viteitter*  
 Secretary

*Louis Roberts*  
 Director, Division of Zoning

*J.F. Ashworth*  
 Chief, Office of Technical Controls



**NOTE:**

- indicates Zoning District boundary.
- The area enclosed by the fine dotted line is proposed to be changed by establishing a C2-2 District within an existing R3-2 District.
- Indicates a C2-2 District.

RC. F.C. ✓ HC

O.F.  
 A-723 ✓  
 Jan 26, 67  
 ends 12, 31, 66

- 411 -

C.P. 19603

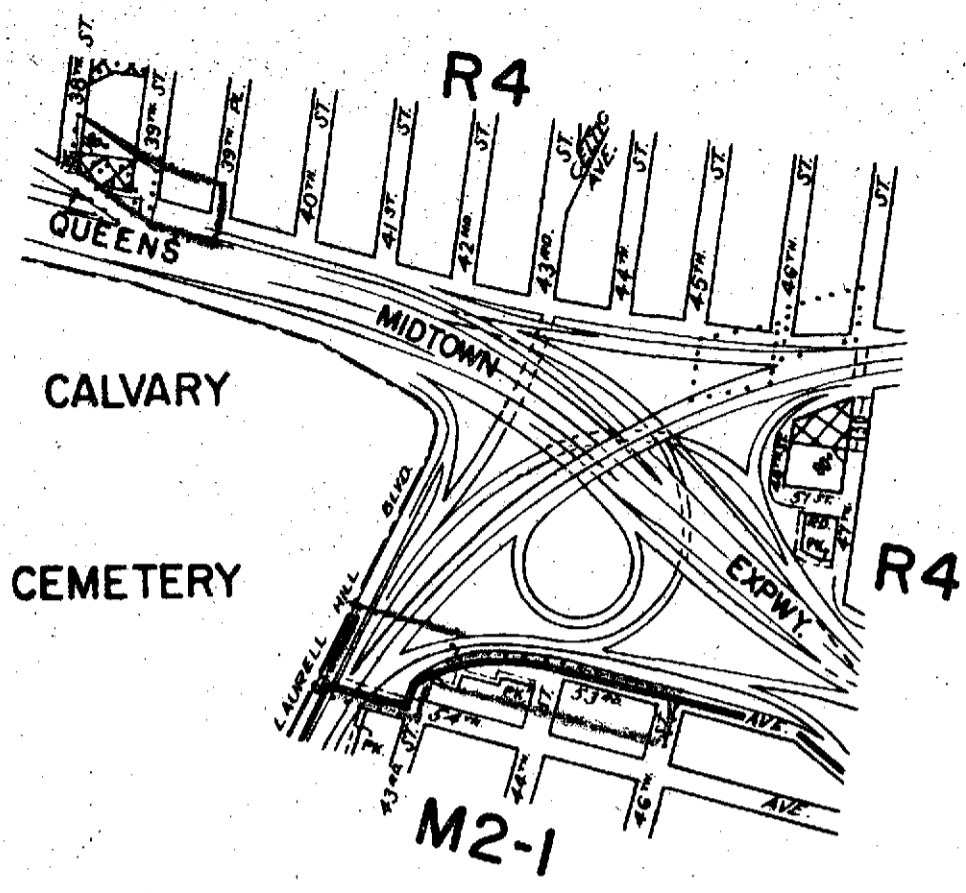

CITY PLANNING COMMISSION  
 CITY OF NEW YORK  
**DIAGRAM SHOWING PROPOSED  
 ZONING CHANGE  
 ON SECTIONAL MAP**

13a  
 BOROUGH OF  
 QUEENS

New York, November 30, 1966

*J. A. Vitiello*  
 Secretary

*Louis Robert*

Director, Division of Zoning  
*J. F. Ashworth*  
 Chief, Office of Technical Controls

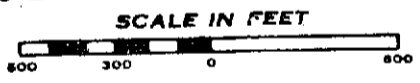

- NOTE:**
- indicates Zoning District boundary.
  - The areas enclosed by the fine dotted lines are proposed to be changed from an R4 District to an M2-1 District and by eliminating C1-2 and C2-2 Districts from an existing R4 District.
  - Indicates a C2-2 District.
  - Indicates a C1-2 District.

R.C. F.C. M2.

A-724  
 Jan 26, 67  
 Ends 2/3/67

C.P. 19633

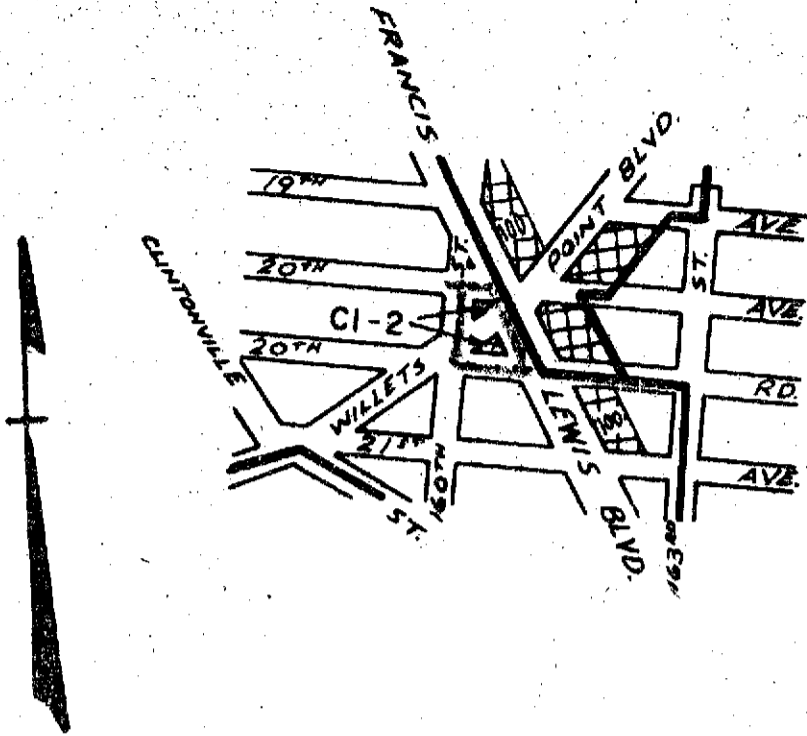

CITY PLANNING COMMISSION  
 CITY OF NEW YORK  
**DIAGRAM SHOWING PROPOSED  
 ZONING CHANGE  
 ON SECTIONAL MAP**

10c  
 BOROUGH OF  
 QUEENS

New York, December 14, 1966

*John A. Vititti*  
 Secretary

*Louis Roberts*  
 Director, Division of Zoning

*J. F. Ashworth*  
 Chief, Office of Technical Controls

SCALE IN FEET



**NOTE:**

- indicates Zoning District boundary.
- The area enclosed by the fine dotted line is proposed to be changed by establishing a CI-2 District within an existing R3-1 District.
- indicates a CI-2 District.

N.A.P.

*FK*

*A-731*

*[Signature]*

*3/2/67*

*ends 2/8/67*

C.P. 19684

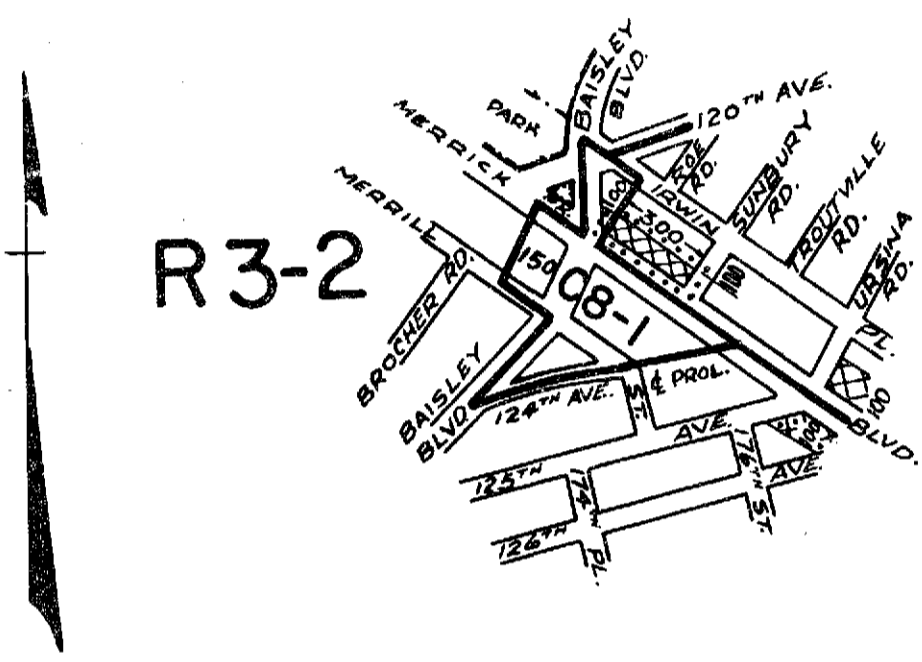

CITY PLANNING COMMISSION  
 CITY OF NEW YORK  
 DIAGRAM SHOWING PROPOSED  
 ZONING CHANGE  
 ON SECTIONAL MAP

19a  
 BOROUGH OF  
 QUEENS

New York, February 2, 1967  
*John A. Vitiello*  
 Secretary

*Louis Roberti*  
 Director, Division of Zoning  
*J. F. Ashworth*  
 Chief, Office of Technical Controls



- NOTE:**
- indicates Zoning District boundary.
  - The area enclosed by the fine dotted line is proposed to be changed by establishing a C1-2 District within an existing R4 District.
  - indicates a C1-2 District.
  - indicate a C2-2 District.

N. A. P.

A-740  
 E.D. April 20, 67

~~ends May 12, 67~~  
 ends 9/8/67  
Revised

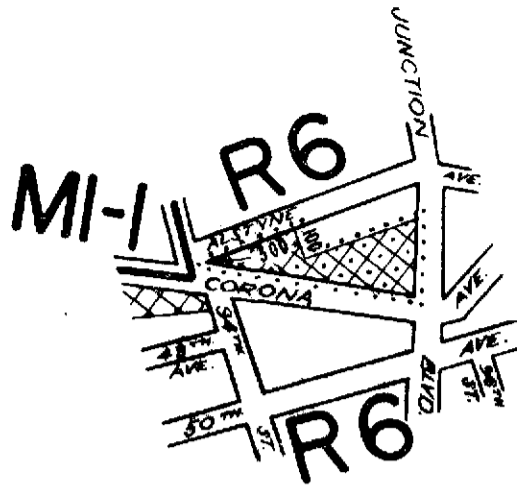

CITY PLANNING COMMISSION  
CITY OF NEW YORK  
**DIAGRAM SHOWING PROPOSED  
ZONING CHANGE  
ON SECTIONAL MAPS**

9d & 10b  
BOROUGH OF  
QUEENS

New York, February 21, 1967

*John A. Vitell*  
Secretary

*Louia Roberts*  
Director, Division of Zoning

*J. F. Ashworth*  
Chief, Office of Technical Controls

SCALE IN FEET

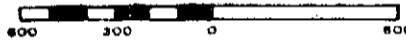

**NOTE:**

- indicates Zoning District boundary.
- The area enclosed by the fine dotted line is proposed to be changed by establishing a C2-2 District within an existing R6 District.
- indicates a C1-2 District.
- indicates a C2-2 District.

R.C.

FC

102

A-745

May 18, 1967

E. D. April 29, 67

R6

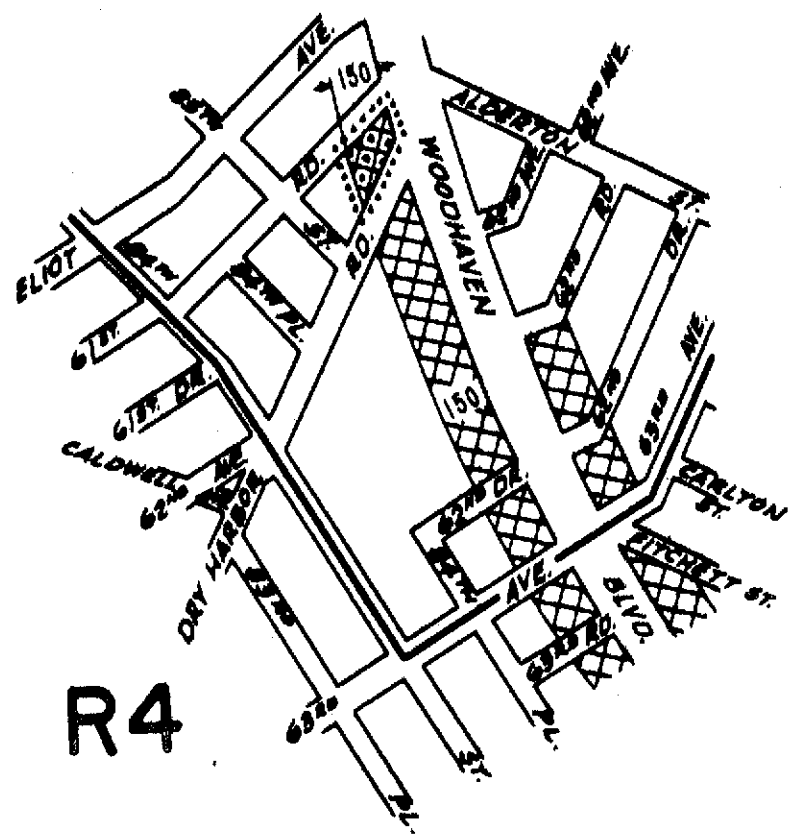

R4

CITY PLANNING COMMISSION  
 CITY OF NEW YORK  
 DIAGRAM SHOWING PROPOSED  
 ZONING CHANGE  
 ON SECTIONAL MAP

13c  
 BOROUGH OF  
 QUEENS

New York, March 29, 1967

*John A. Vitentini*  
 Secretary

*Louis Roberts*  
 Director, Division of Zoning

*J. F. Ashworth*  
 Chief, Office of Technical Controls

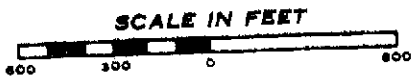

- NOTE:**
- indicates Zoning District boundary.
  - The area enclosed by the fine dotted line is proposed to be changed by establishing a C2-2 District within an existing R6 District.
  - indicates a C1-2 District.
  - indicates a C2-2 District.

\* F.C. RR

F.D. June 22, 67

A- 755

end June 3,

412-

C.R. 19719

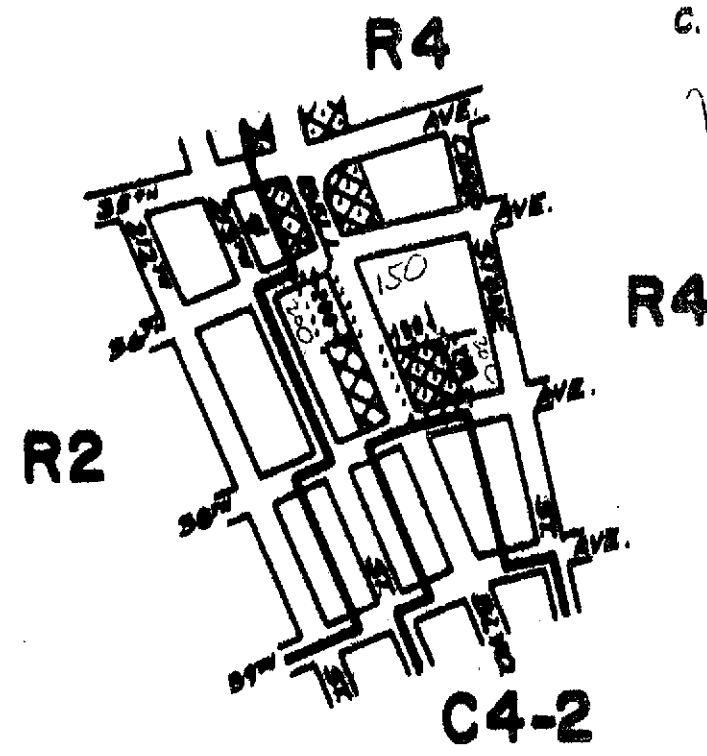

CITY PLANNING COMMISSION  
 CITY OF NEW YORK  
**DIAGRAM SHOWING PROPOSED  
 ZONING CHANGE  
 ON SECTIONAL MAP**

11a  
 BOROUGH OF  
 QUEENS

New York, March 29, 1967

*John A. Vitelli*  
 Secretary

*Louis Roberts*  
 Director, Division of Zoning  
*J. F. Ashworth*  
 Chief, Office of Technical Controls



- NOTE:**
- indicates Zoning District boundary.
  - ..... The area enclosed by the fine dotted line is proposed to be changed by eliminating a C1-2 District and establishing a C2-2 District within an existing R4 District.
  - XXXXXX indicates a C1-2 District.
  - XXXXXX indicates a C2-2 District.

A.J.P. F.C. Mc

A-751  
 E.D. 6/9/67  
 and June 3, 67  
 OK  
 F.C.  
 J.T.

411c-

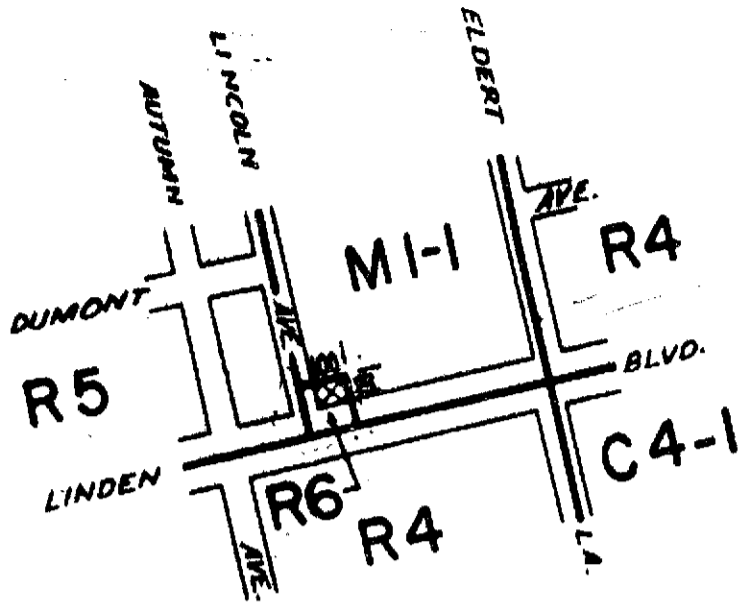

CITY PLANNING COMMISSION  
 CITY OF NEW YORK  
 DIAGRAM SHOWING PROPOSED  
 ZONING CHANGE  
 ON SECTIONAL MAP

18b

BOROUGH OF QUEENS

New York, March 29, 1967

*John A. Vitelli*  
 Secretary

*Louis Robert*  
 Director, Division of Zoning

*J. F. Ashworth*  
 Chief, Office of Technical Controls

SCALE IN FEET



- NOTE:**
- indicates Zoning District boundary.
  - The area enclosed by the fine dotted line is proposed to be changed from an MI-1 District to R6 and C1-2 Districts.
  - indicates a CI-2 District.

*J.B. F.C. Mc*

*A-748*

*Date filed*

*May 18, 67*

*Ends June 3, 67*



C.P. 19771

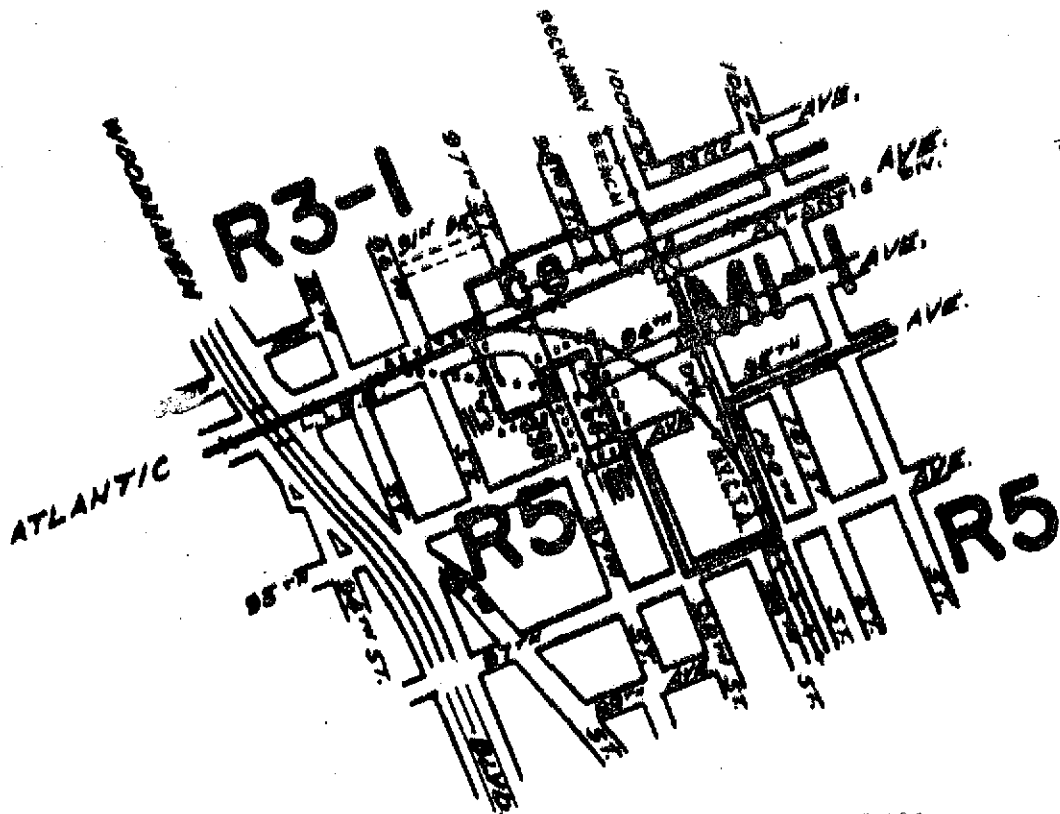

CITY PLANNING COMMISSION  
 CITY OF NEW YORK  
**DIAGRAM SHOWING PROPOSED  
 ZONING CHANGE  
 ON SECTIONAL MAP  
 180**  
 BOROUGH OF  
 QUEENS

New York, April 12, 1967

*John A. Vitelliti*  
 Secretary

*Louis Robert*  
 Director, Division of Zoning

*J. F. Ashworth*  
 Chief, Office of Technical Controls



**NOTE:**  
 ————— indicates Zoning District boundary.  
 ..... The area enclosed by the fine dotted line is proposed to be changed from MI-1 and R5 Districts to R5 and MI-1 Districts.

G.M. F.C. - JRB

A-756  
 E.D. June 22, 67 OK  
 ends June 25, 67 F.C.

MI-1

C4-2

R6

R7-1

R6

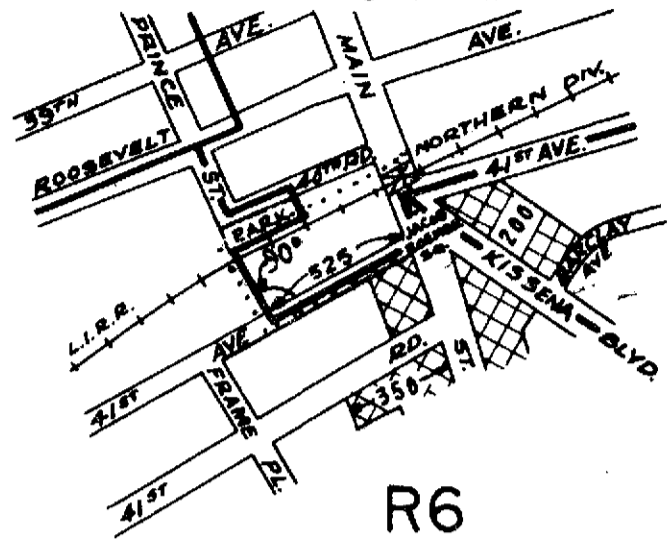
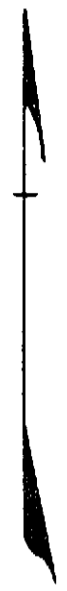

CITY PLANNING COMMISSION  
CITY OF NEW YORK  
DIAGRAM SHOWING PROPOSED  
ZONING CHANGE  
ON SECTIONAL MAP



10b  
BOROUGH OF  
QUEENS

New York, May 3, 1967

*John A. Vitentti*  
Secretary

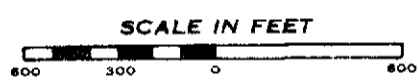
*Louis Roberti*  
Director, Division of Zoning  
*J. F. Ashworth*  
Chief, Office of Technical Controls



- NOTE:**
-  indicates Zoning District boundary.
  -  The area enclosed by the fine dotted line is proposed to be changed from R6 and C1-2 Districts to a C4-2 District.
  -  indicates a C1-2 District.

A.J.P. F.C. 4

A-758 F.C.  
E.D. June 22, 67 V.T.  
encl 7, 9, 67

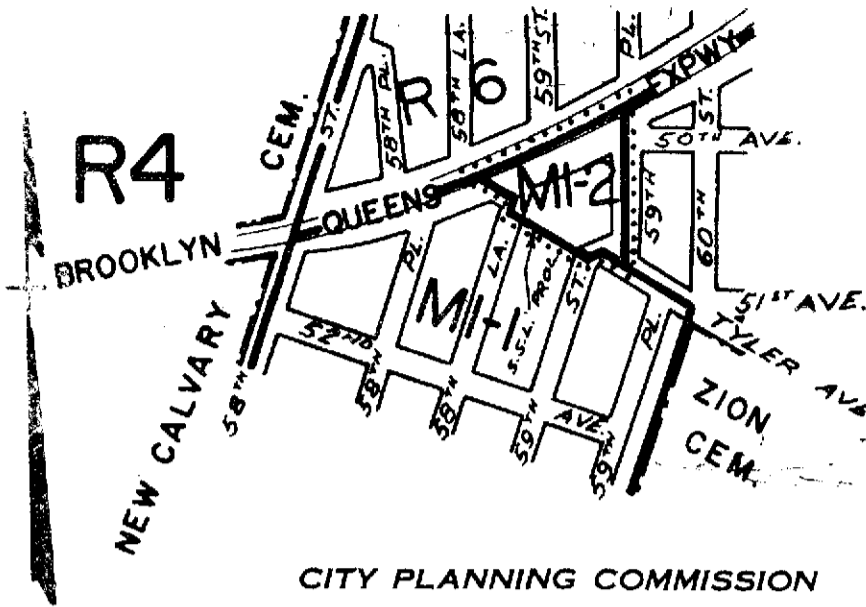

CITY PLANNING COMMISSION  
 CITY OF NEW YORK  
 DIAGRAM SHOWING PROPOSED  
 ZONING CHANGE  
 ON SECTIONAL MAP

13c  
 BOROUGH OF  
 QUEENS

New York, May 3, 1967

*John G. Vitetta*  
 Secretary

*Louie Roberts*  
 Director, Division of Zoning

*J. F. Ashworth*  
 Chief, Office of Technical Controls



NOTE:

- indicates Zoning District boundary.
- ..... The area enclosed by the fine dotted line is proposed to be changed from R4 and MI-1 Districts to an MI-2 District.

N.A.P.  
 R.

*double check mapping in  
 This Area OK on Tracing*

*A-824  
 9/25/68*

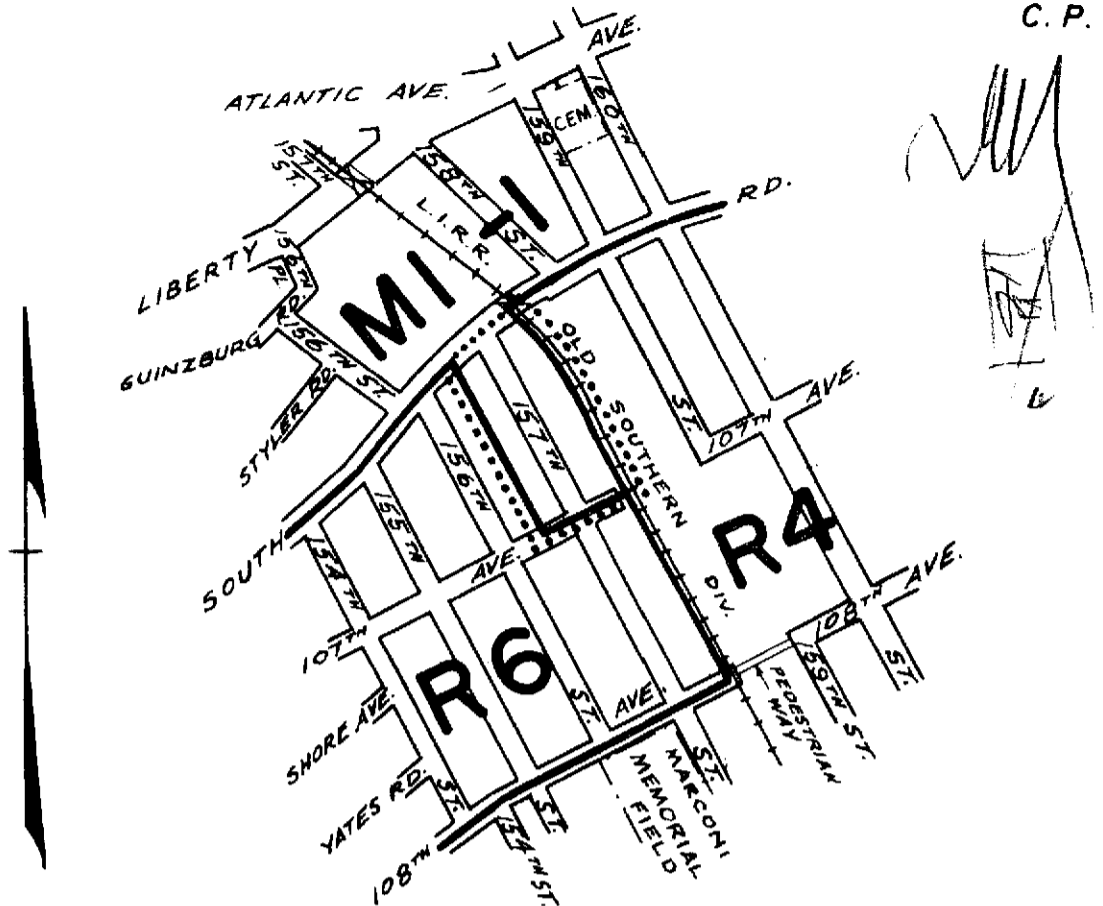

CITY PLANNING COMMISSION  
 CITY OF NEW YORK  
 DIAGRAM SHOWING PROPOSED  
 ZONING CHANGE  
 ON SECTIONAL MAP

14 d  
 BOROUGH OF  
 QUEENS

New York, May 24, 1967  
*John A. Vitinetti*  
 Secretary

*Louie Roberts*  
 Director, Division of Zoning  
*J. F. Ashworth*  
 Chief, Office of Technical Controls



**NOTE:**  
 ————— indicates Zoning District boundary.  
 ..... The area enclosed by the fine dotted line is proposed to be changed from  
 an R6 District to an MI-1 District.

C.H.  
 A-768  
 Aug. 29, 1967  
 ends Aug 19, 67

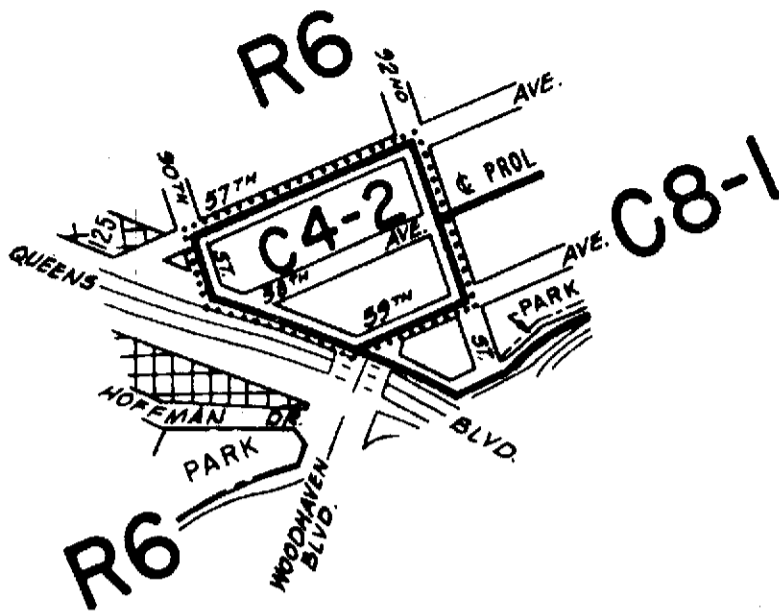

CITY PLANNING COMMISSION  
 CITY OF NEW YORK  
 DIAGRAM SHOWING PROPOSED  
 ZONING CHANGE  
 ON SECTIONAL MAP

13c  
 BOROUGH OF  
 QUEENS



New York, July 19, 1967

*John C. Vitti*  
 Secretary

*Louis Roberts*  
 Director, Division of Zoning

*J. F. Ashworth*  
 Chief, Office of Technical Controls

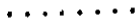

- NOTE:**
-  indicates Zoning District boundary.
  -  The area enclosed by the fine dotted line is proposed to be changed from R6 and C8-1 Districts to a C4-2 District.
  -  indicates a C1-2 District.

HC

A-904

Sept 18, 69

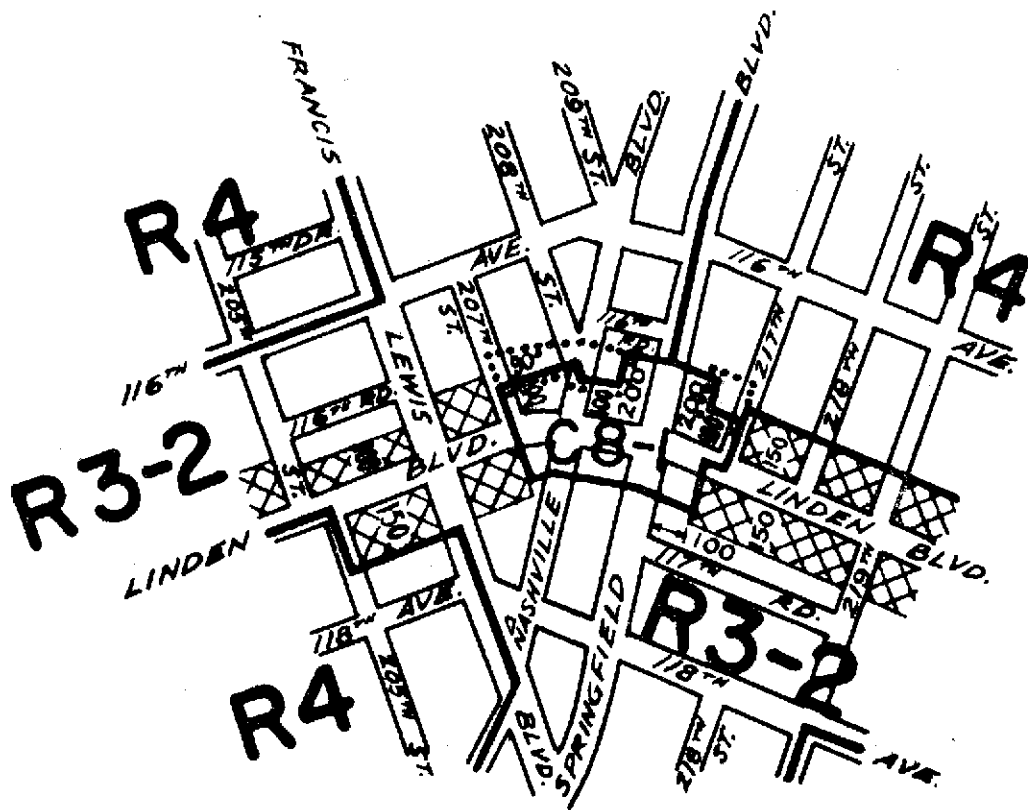

CITY PLANNING COMMISSION  
 CITY OF NEW YORK  
**DIAGRAM SHOWING PROPOSED  
 ZONING CHANGE  
 ON SECTIONAL MAP**

**15b**  
 BOROUGH OF  
 QUEENS

New York, August 16, 1967



*John G. Vitti*  
 Secretary

*Louisa Roberts*  
 Director, Division of Zoning

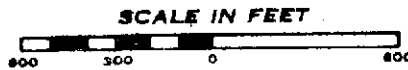
*J.F. Ashworth*  
 Chief, Office of Technical Controls



**NOTE:**

-  indicates Zoning District boundary.
-  The areas enclosed by the fine dotted lines are proposed to be changed from a C1-2 District to R3-2 and R4 Districts.
-  indicates a C1-2 District.

*C.H. YIT. hls*

A-796

E.D. NOV. 22, 67

ends Nov. 8, 67

*Rush*

TO BE INDEXED  
INDEXED ✓

C.P. 19925

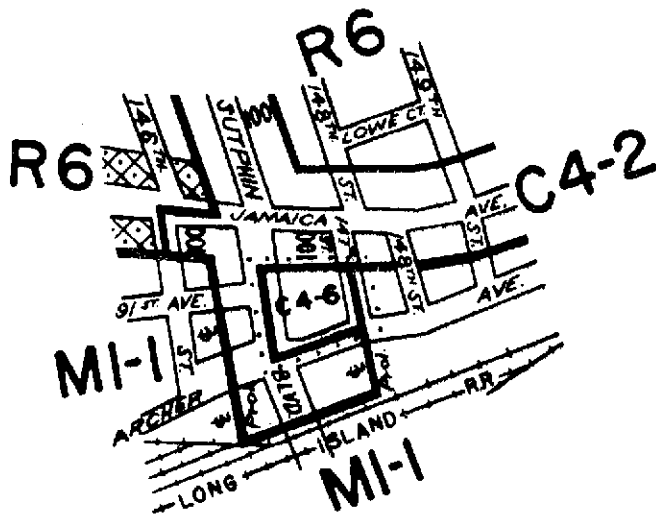

CITY PLANNING COMMISSION  
 CITY OF NEW YORK  
**DIAGRAM SHOWING PROPOSED  
 ZONING CHANGE  
 ON SECTIONAL MAP  
 14 d**

BOROUGH OF  
QUEENS

New York, August 16, 1967



*James A. Vitell*  
 Secretary

*Louis Roberti*  
 Director, Division of Zoning

*J.F. Ashworth*  
 Chief, Office of Technical Controls



**NOTE:**

-  indicates Zoning District boundary.
-  The area enclosed by the fine dotted line is proposed to be changed from a C4-2 District to a C4-6 District.
-  Indicates a C2-2 District.

PC

AP

A-783 - Oct 25, 67

Ends 11/8/67 ✓

*[Handwritten initials]*

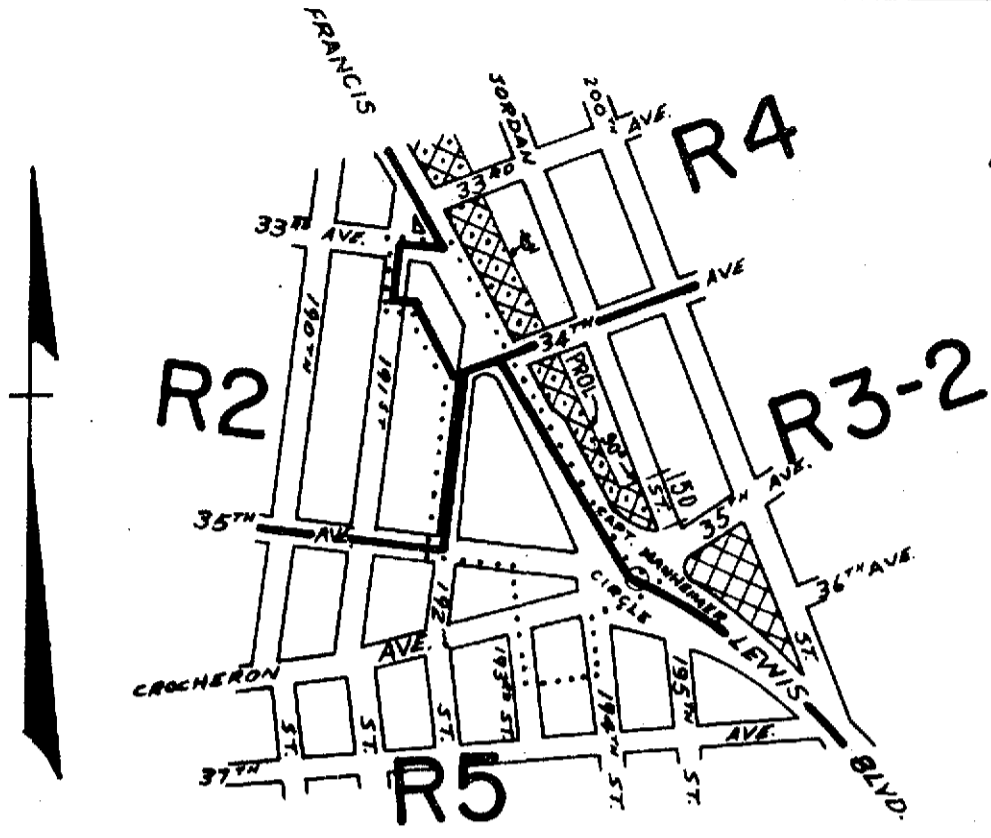

CITY PLANNING COMMISSION  
 CITY OF NEW YORK  
**DIAGRAM SHOWING PROPOSED  
 ZONING CHANGE  
 ON SECTIONAL MAP**  
 10c  
 BOROUGH OF  
 QUEENS

New York, August 16, 1967

*James A. Vitenti*  
 Secretary

*Louie Roberts*  
 Director, Division of Zoning

*J.F. Ashworth*  
 Chief, Office of Technical Controls



- NOTE:**
- indicates Zoning District boundary.
  - The area enclosed by the fine dotted line is proposed to be changed by eliminating a C2-2 District from R3-2, R4 and R5 Districts and by changing R2 and R3-2 Districts to an R5 District.
  - indicates a C1-2 Districts
  - indicates a C2-2 District.

N.A.P. 79

A-784 /  
 Oct 25, 67  
 Bonds - Nov 8, 67



R3-2

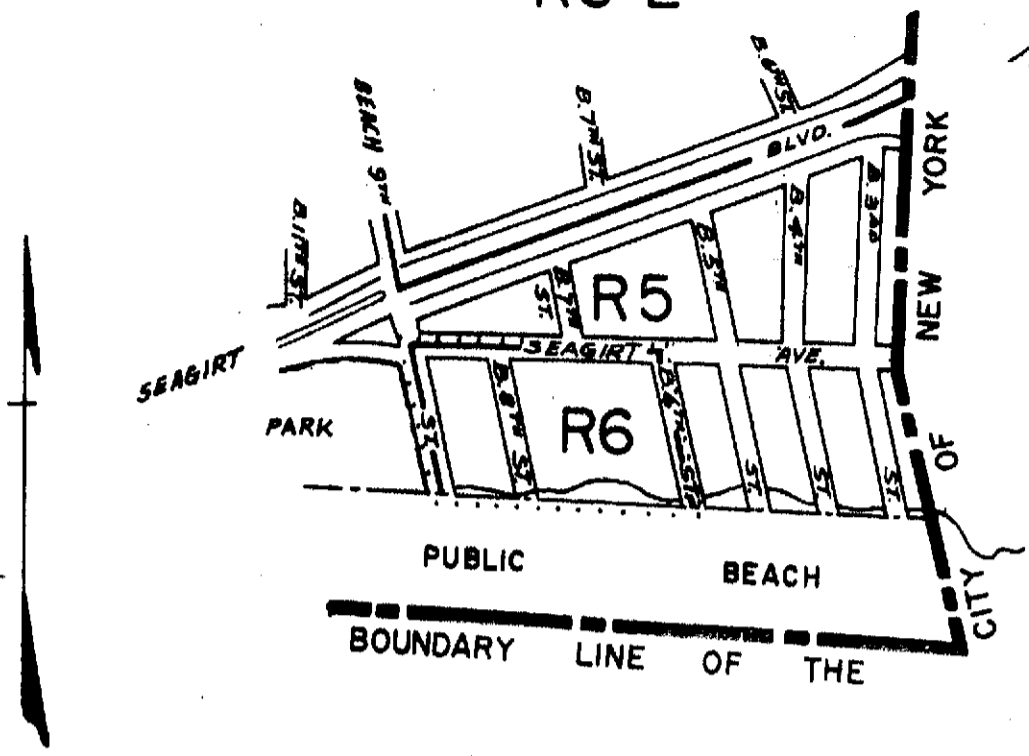

CITY PLANNING COMMISSION  
 CITY OF NEW YORK  
**DIAGRAM SHOWING PROPOSED  
 ZONING CHANGE  
 ON SECTIONAL MAP**

**31a**  
 BOROUGH OF  
 QUEENS

MODIFIED OCTOBER 18, 1967  
 New York, August 16, 1967

*John C. Vitelli*  
 Secretary

*Louis Roberts*  
 Director, Division of Zoning

*J.F. Ashworth*  
 Chief, Office of Technical Controls



**NOTE:**

- indicates Zoning District boundary.
- .....** The area enclosed by the fine dotted line is proposed to be changed from an R5 District to an R6 District.

A.J.P. F.C.

MODIFICATION

A-787

Oct 25, 1967 E.D.

NOV. 17, 67 ends

*Handwritten initials/signature*

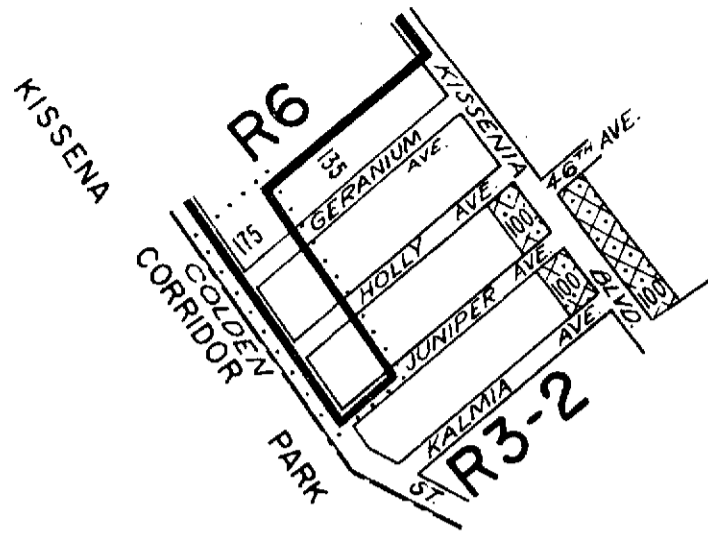
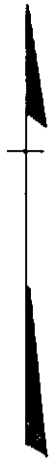

*Map*

CITY PLANNING COMMISSION  
 CITY OF NEW YORK  
**DIAGRAM SHOWING PROPOSED  
 ZONING CHANGE  
 ON SECTIONAL MAP  
 10 d**  
 BOROUGH OF  
 QUEENS

New York, August 24, 1967  
*Benjamin Goldstein*  
 Actg. Secretary

*Julius Loewenthal*  
 Acting Director, Division of Zoning  
*J. F. Ashworth*  
 Chief, Office of Technical Controls



- NOTE:**
- indicates Zoning District boundary.
  - The area enclosed by the fine dotted line is proposed to be changed from an R3-2 District to an R6 District.
  - indicates a C2-2 District.

*A-804*  
*Dec. 7, 1967*  
*Completed J.T.*

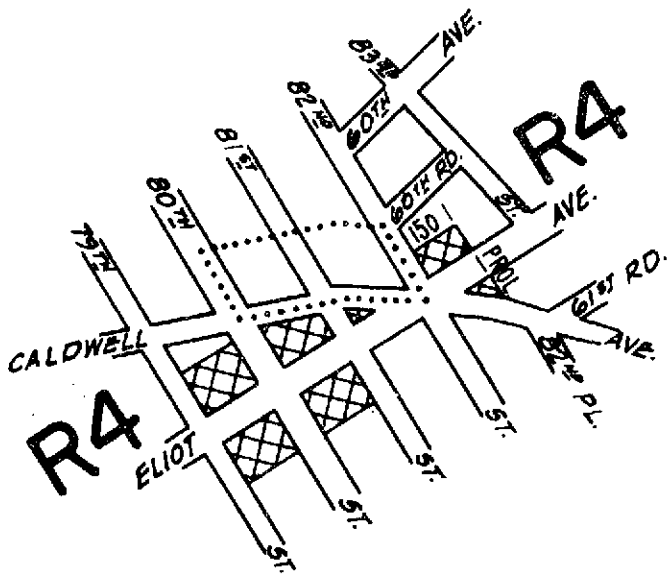

CITY PLANNING COMMISSION  
 CITY OF NEW YORK  
**DIAGRAM SHOWING PROPOSED  
 ZONING CHANGE  
 ON SECTIONAL MAP  
 13c  
 BOROUGH OF  
 QUEENS**

New York, September 11, 1967

*John G. Vitenti*  
 Secretary

*Louise Roberts*  
 Director, Division of Zoning

*J. F. Ashworth*  
 Chief, Office of Technical Controls



- NOTE:**
- indicates Zoning District boundary.
  - The area enclosed by the fine dotted line is proposed to be changed by eliminating a CI-2 District within an existing R4 District.
  - indicates a CI-2 District.

HC ✓ HC

A- 786

Oct 25, 67

ends Nov. 17, 67

*[Handwritten mark]*

*not* *not*

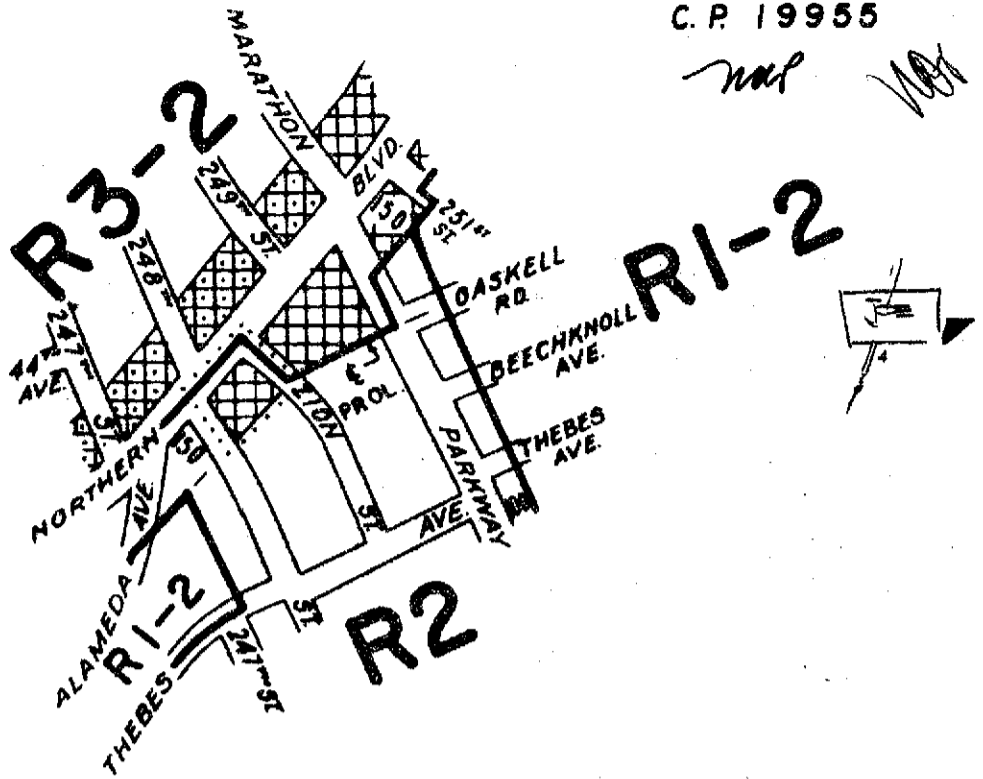

CITY PLANNING COMMISSION  
 CITY OF NEW YORK  
**DIAGRAM SHOWING PROPOSED  
 ZONING CHANGE  
 ON SECTIONAL MAP  
 11a**

BOROUGH OF QUEENS

New York, September 11, 1967

*John C. Vitell*  
 Secretary

*Louise Roberts*  
 Director, Division of Zoning

*J. F. Ashworth*  
 Chief, Office of Technical Controls

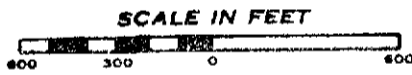

- NOTE:**
- indicates Zoning District boundary.
  - The area enclosed by the fine dotted line is proposed to be changed by establishing a C1-2 District within an existing R2 District.
  - indicates a C1-2 District.
  - indicates a C2-2 District.

C. S. M.

OK.

A-790

Nov. 9, 1967

ends Nov 17, 67

-4112-

C. P. 19987

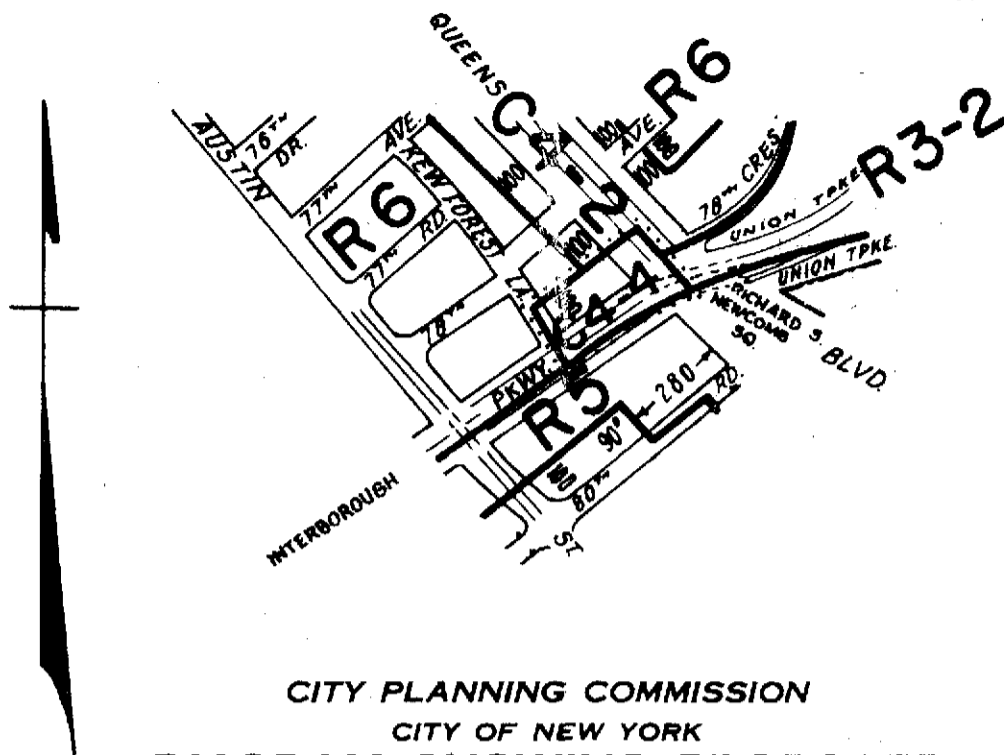

CITY PLANNING COMMISSION  
 CITY OF NEW YORK  
**DIAGRAM SHOWING PROPOSED  
 ZONING CHANGE  
 ON SECTIONAL MAP  
 14b**

BOROUGH OF  
QUEENS

New York, October 4, 1967

*John A. Vitelli*  
Secretary

*Louis Roberts*  
Director, Division of Zoning

*J. F. Ashworth*  
Chief, Office of Technical Controls

SCALE IN FEET



**NOTE:**

- indicates Zoning District boundary.
- .....** The area enclosed by the fine dotted line is proposed to be changed from a C4-2 District to a C4-4 District.

*CSM 817-*

*A-801*

*Dec. 7, 67*

*Completed*  
*J.F.T.* ✓

*OK.*  
*F.C.*  
*V.T.*

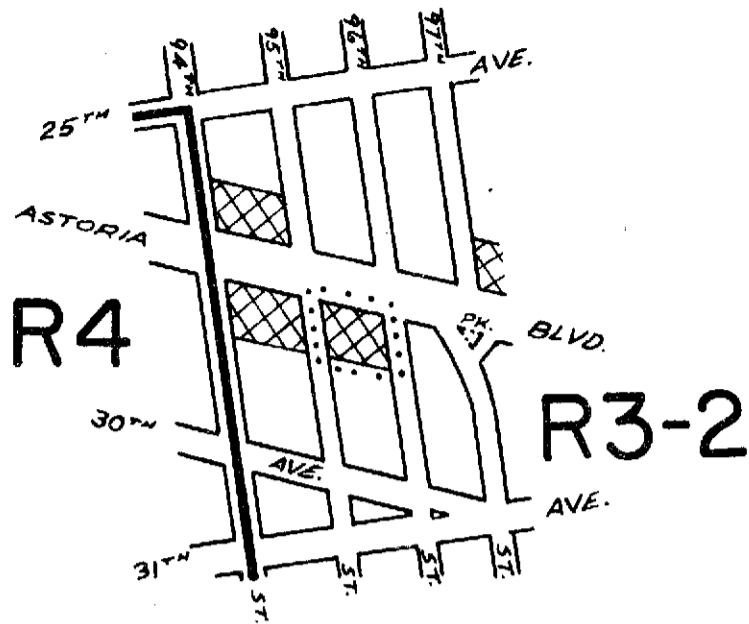

CITY PLANNING COMMISSION  
 CITY OF NEW YORK  
**DIAGRAM SHOWING PROPOSED  
 ZONING CHANGE  
 ON SECTIONAL MAP**

**9c**  
 BOROUGH OF  
 QUEENS

New York, October 4, 1967

*John A. Vitaitti*  
 Secretary

*Louis Robert*  
 Director, Division of Zoning

*J.F. Ashworth*  
 Chief, Office of Technical Controls



**NOTE:**

- indicates Zoning District boundary.
- The area enclosed by the fine dotted line is proposed to be changed by establishing a CI-2 District within an existing R3-2 District.
- indicates a CI-2 District.

N.A.P. 7-1 S.C.

A-930

F.C.

JAN 8, 70

ends 1, 28, 70

*Handwritten initials*

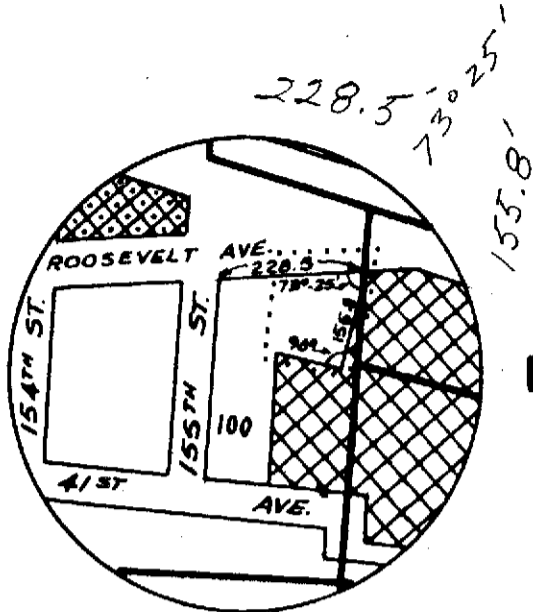

**EXAGGERATED SKETCH**

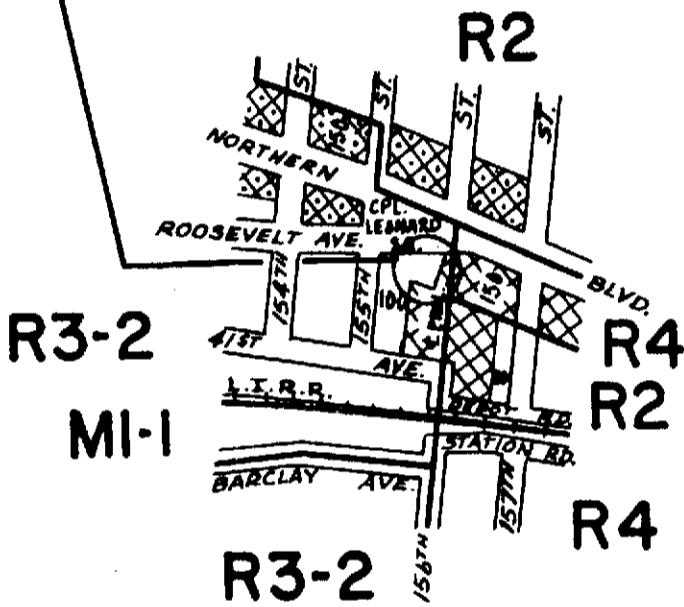

**CITY PLANNING COMMISSION  
CITY OF NEW YORK  
DIAGRAM SHOWING PROPOSED  
ZONING CHANGE  
ON SECTIONAL MAP**

**10c**

**BOROUGH OF  
QUEENS**

New York, October 4, 1967

*John G. Vicentini*  
Secretary

*Louise Roberts*  
Director, Division of Zoning

*J. F. Ashworth*  
Chief, Office of Technical Controls

SCALE IN FEET

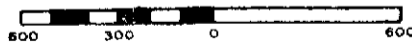

**NOTE:**

- indicates Zoning District boundary.
- The area enclosed by the fine dotted line is proposed to be changed by eliminating a C1-2 District from within an existing R3-2 District.
- indicates a C1-2 District.
- indicates a C2-2 District.

*Completed*  
*A-802*  
*Y.H.T.*  
*555*  
*Dec. 7, 67*  
*FC*  
*ST*

C. P. 20016

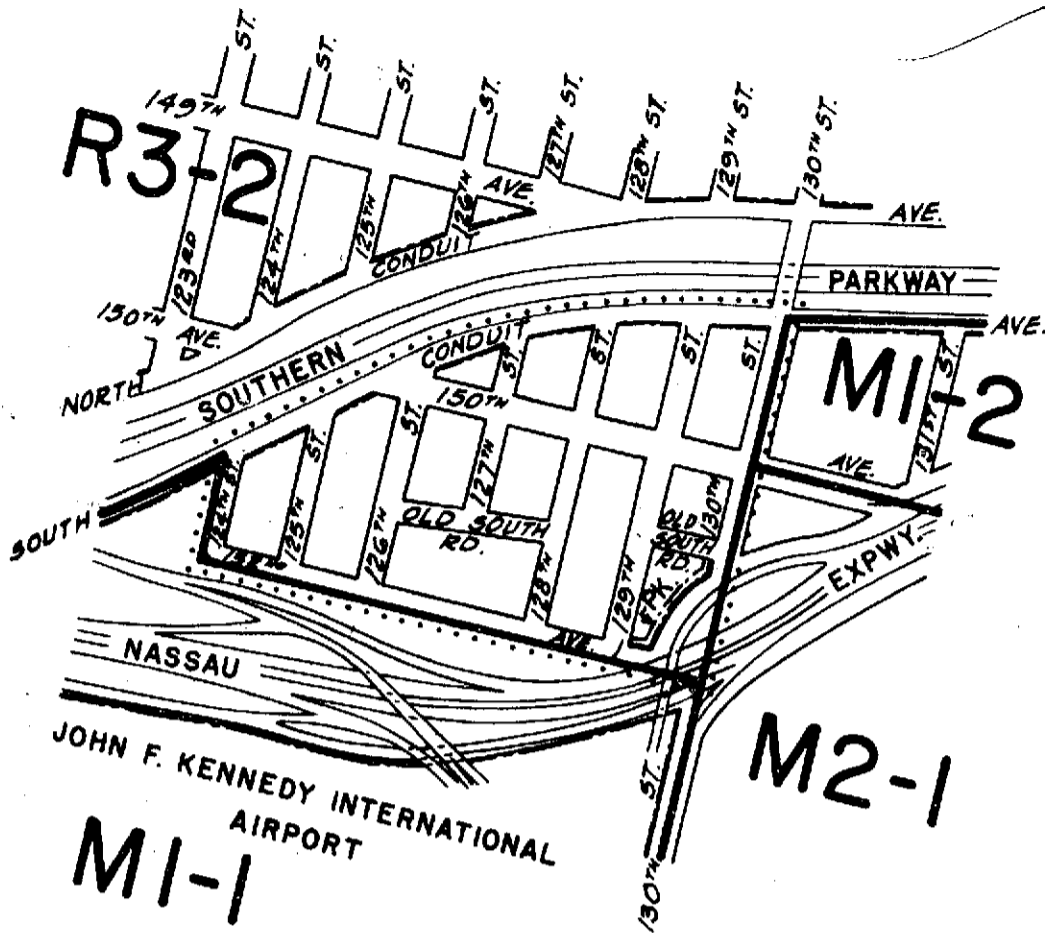

CITY PLANNING COMMISSION  
 CITY OF NEW YORK  
**DIAGRAM SHOWING PROPOSED  
 ZONING CHANGE  
 ON SECTIONAL MAP  
 18d**  
 BOROUGH OF  
 QUEENS

New York, October 18, 1967

*John A. Vicauti*  
 Secretary

*Louis Roberts*  
 Director, Division of Zoning

*J. F. Ashworth*  
 Chief, Office of Technical Controls

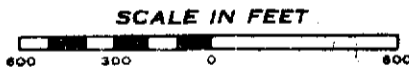

**NOTE:**  
 ————— indicates Zoning District boundary.  
 ..... The area enclosed by the fine dotted line is proposed to be changed from  
 an MI-1 District to an R3-2 District.

*Hc Hc ✓ Hc*

*A-826*



C. P. 20025

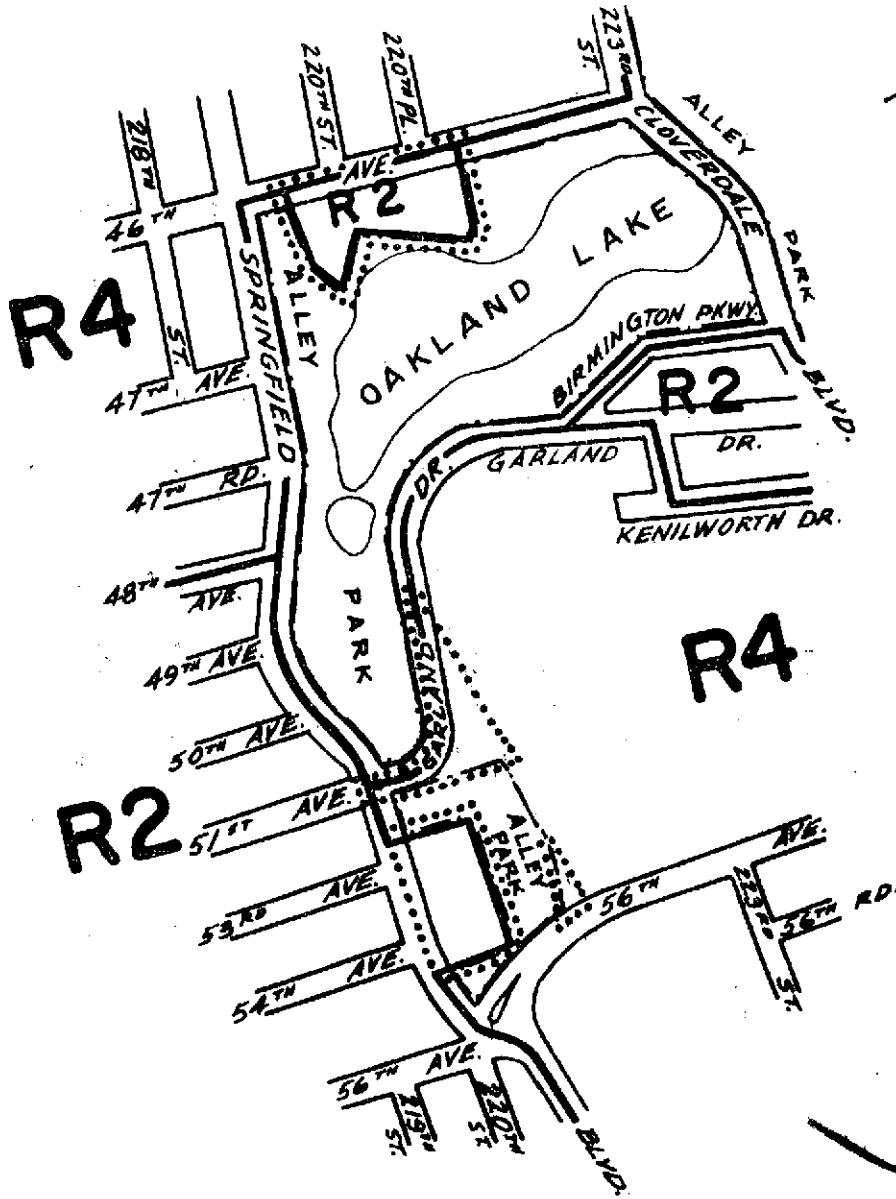

CITY PLANNING COMMISSION  
 CITY OF NEW YORK  
 DIAGRAM SHOWING PROPOSED  
 ZONING CHANGE  
 ON SECTIONAL MAP

11b

BOROUGH OF  
 QUEENS

New York, November 1, 1967

*Benjamin Goldstein*  
 Acting Secretary

*Louie Roberts*  
 Director, Division of Zoning

*J.F. Ashworth*  
 Chief, Office of Technical Controls

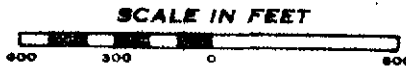

NOTE:

- indicates Zoning District boundary.
- .....** The areas enclosed by the fine dotted lines are proposed to be designated as R2 and R4 Districts.

*E.H. V.H.*

A-805

Completed  
 11/7/67

FC Dec. 7, 1967

*Met*

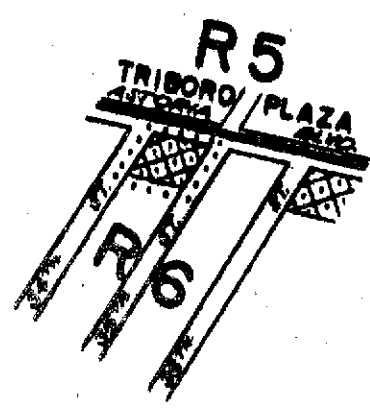

CITY PLANNING COMMISSION  
CITY OF NEW YORK  
**DIAGRAM SHOWING PROPOSED  
ZONING CHANGE  
ON SECTIONAL MAP**

9a

BOROUGH OF  
QUEENS

New York, November 15, 1967



*John A. Vitelli*  
Secretary

*Louis Robert*  
Director, Division of Zoning

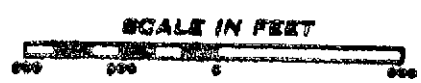
*J.F. Ashworth*  
Chief, Office of Technical Controls



**NOTE:**

-  Indicates Zoning District boundary.
-  The area enclosed by the fine dotted line is proposed to be changed by establishing a C2-2 District within an existing R5 District.
-  Indicates a C2-2 District.

*KC 1/15*

*FC*

*A-809*

*December 21, 67*

*ends ~~Dec 1 67~~ Jan 12 68*

**HAS TO BE DONE.**

- 414 -

C. P. 20141

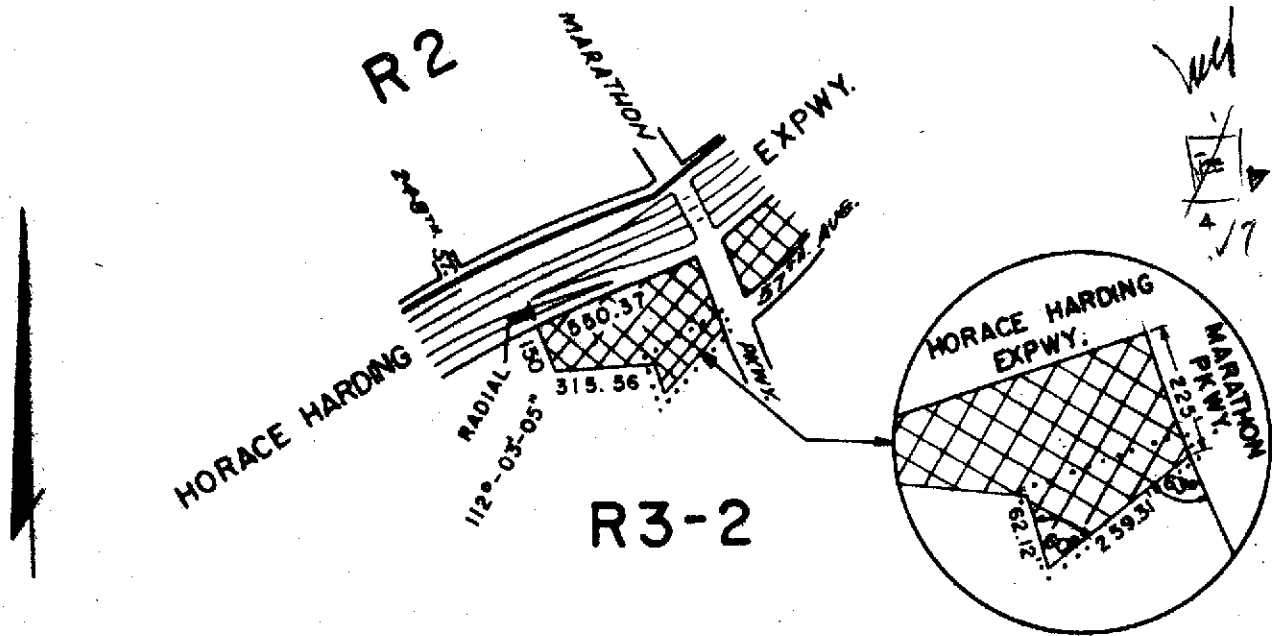

CITY PLANNING COMMISSION  
 CITY OF NEW YORK  
 DIAGRAM SHOWING PROPOSED  
 ZONING CHANGE  
 ON SECTIONAL MAP

11d  
 BOROUGH OF  
 QUEENS

*Louis Roberts*  
 Director, Division of Mapping  
*J. F. Ashworth*  
 Chief, Office of Technical Controls

New York, January 31, 1968  
*Anthony C. Longardo*  
 Acting Secretary



NOTE:

- indicates Zoning District boundary.
- ..... The area enclosed by the fine dotted line is proposed to be changed by establishing a CI-2 District within an existing R3-2 District.
- ▣ indicates a CI-2 District.

J. B. 751.

A-821

ends. 3,29,6P

April 4, 1968

Rush

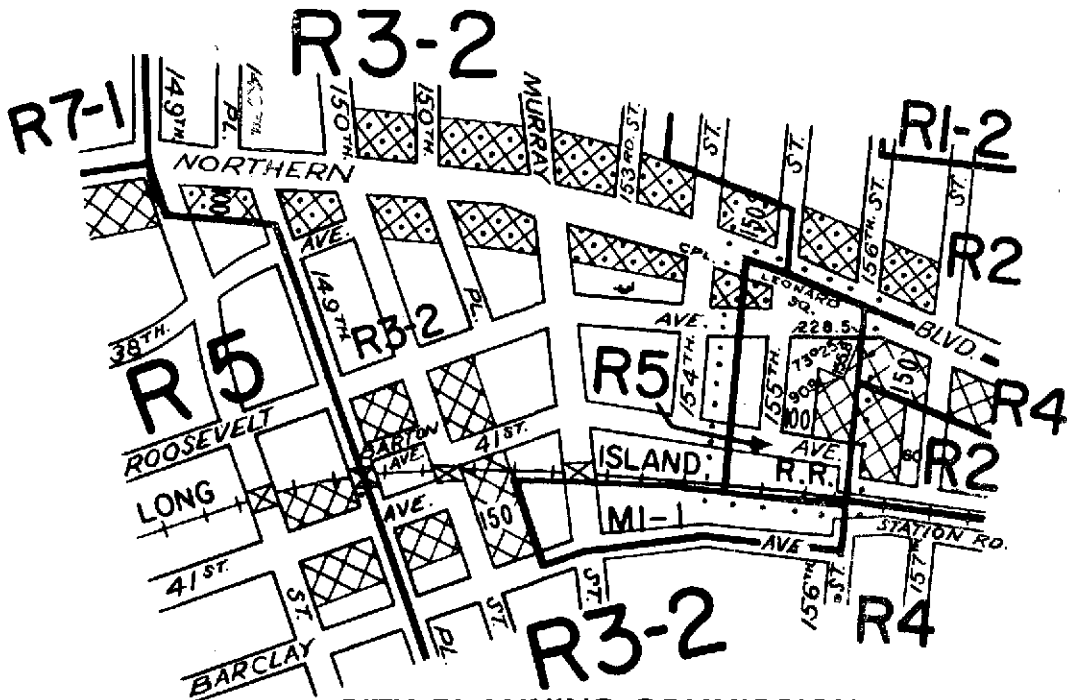



CITY PLANNING COMMISSION  
 CITY OF NEW YORK  
**DIAGRAM SHOWING PROPOSED  
 ZONING CHANGE  
 ON SECTIONAL MAP**

10c  
 BOROUGH OF  
 QUEENS

MODIFIED 6/26/68  
 New York, April 17, 1968  
*Salvatore C. Bagliardo*  
 Acting Secretary

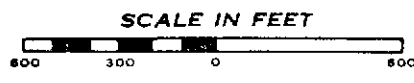
*Louise Roberts*  
 Director, Division of Zoning  
*J. F. Ashworth*  
 Chief, Office of Technical Controls



- NOTE:**
- indicates Zoning District boundary.
  - ..... The area enclosed by the fine dotted line is proposed to be changed from an R3-2 District to an R5 District.
  -  indicates a C1-2 District.
  -  indicates a C2-2 District.

RC

A-841  
 E.D. Aug. 22, 68  
 ends 7, 27, 68

- 411 -

C. P. 20302

50

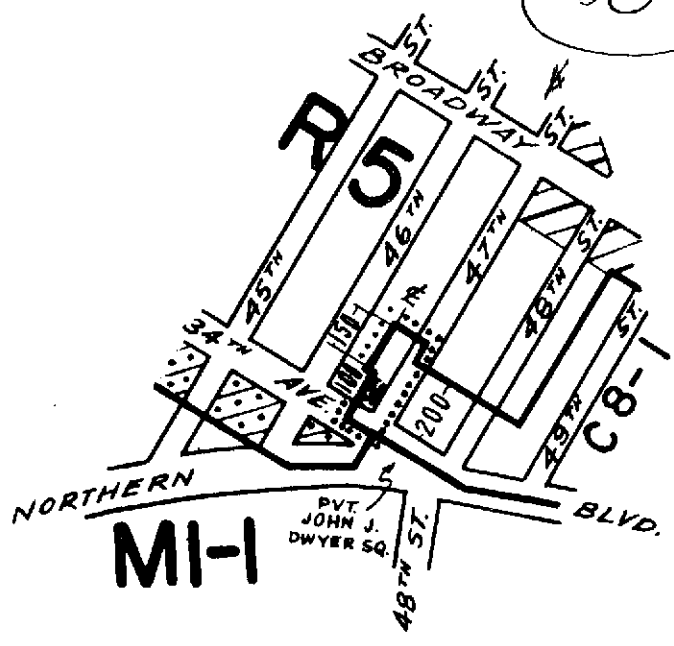
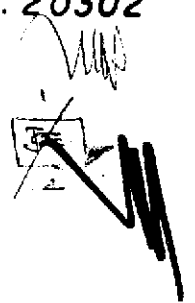

CITY PLANNING COMMISSION  
CITY OF NEW YORK  
DIAGRAM SHOWING PROPOSED  
ZONING CHANGE  
ON SECTIONAL MAP

9b

BOROUGH OF  
QUEENS

*Louis Robert*  
Director, Division of Zoning  
*J.F. Ashworth*  
Chief, Office of Technical Controls

New York, May 15, 1968  
*Salvatore C. Scafardo*  
Acting Secretary



- NOTE:**
- indicates Zoning District boundary.
  - The area enclosed by the fine dotted line is proposed to be changed from an R5 District to a C8-1 District.
  - indicates C1-3 District.
  - indicates C2-1 District.

C.H. 70

A-838

E.D. July 25, 1968

ends July 13, 68

- 4 1/2 -

60

C.P. 20363A

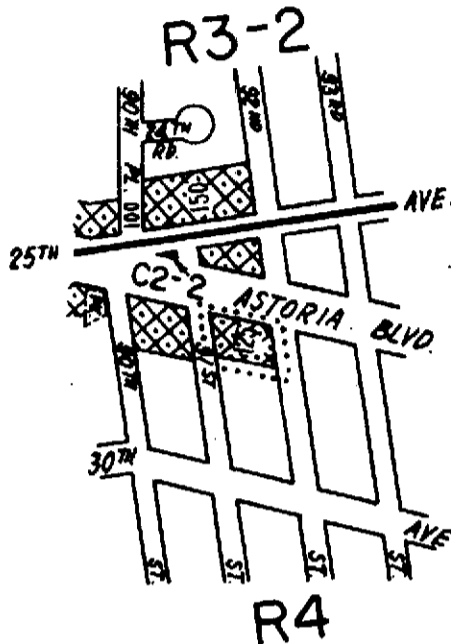

CITY PLANNING COMMISSION  
 CITY OF NEW YORK  
**DIAGRAM SHOWING PROPOSED  
 ZONING CHANGE  
 ON SECTIONAL MAP**

9c  
 BOROUGH OF  
 QUEENS

New York, July 31, 1968

*Salvatore C. Zagardo*  
 Acting Secretary

*Louise Roberts*  
 Director, Division of Zoning

*J.F. Ashworth*  
 Chief, Office of Technical Controls

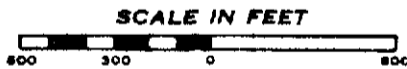

- NOTE:**
- indicates Zoning District boundary.
  - ..... The area enclosed by the fine dotted line is proposed to be changed by establishing a C2-2 District within an existing R4 District.
  -  indicates a C2-2 District.

NR 717 RR

*Correct copy*

*Oct 24, 68*

*A-856*

*encl. 11/15/68*

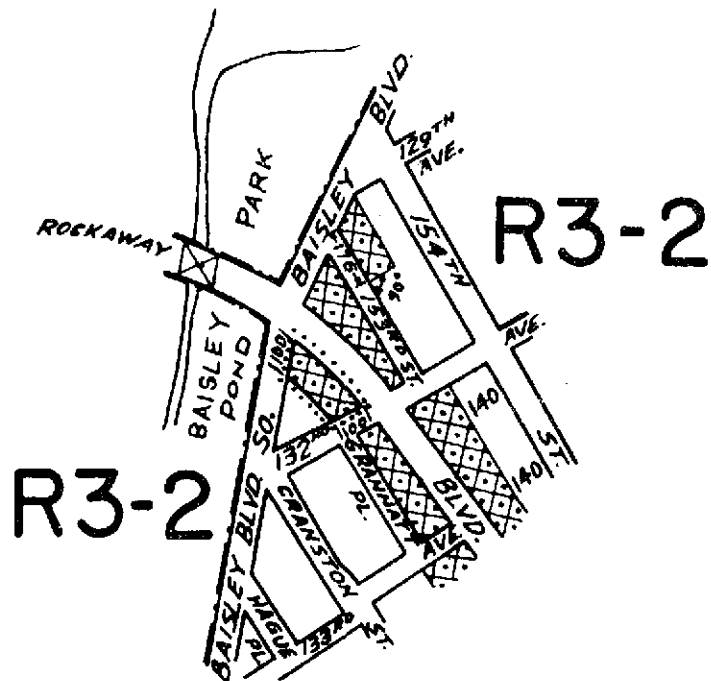

CITY PLANNING COMMISSION  
 CITY OF NEW YORK  
 DIAGRAM SHOWING PROPOSED  
 ZONING CHANGE  
 ON SECTIONAL MAP

18c  
 BOROUGH OF  
 QUEENS

New York, June 26, 1968

*Salvatore C. Bayardo*  
 Acting Secretary



*Louis Roberts*  
 Director, Division of Zoning

*J.F. Ashworth*  
 Chief, Office of Technical Controls

SCALE IN FEET



NOTE:

-  indicates Zoning District boundary.
-  The area enclosed by the fine dotted line is proposed to be changed by establishing a C2-2 District within an existing R3-2 District.
-  indicates a C2-2 District.

N.A.P. 11 *HC*

A-851

OA 10, 1968

ends Nov. 14, 68

C.P. 20505

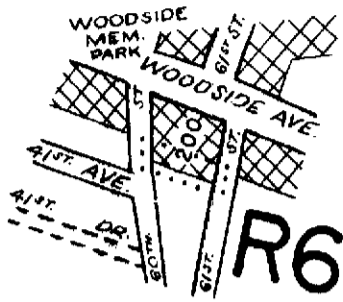
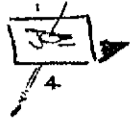

CITY PLANNING COMMISSION  
CITY OF NEW YORK  
DIAGRAM SHOWING PROPOSED  
ZONING CHANGE  
ON SECTIONAL MAP

9d  
BOROUGH OF  
QUEENS

New York, October 30, 1968

*Salvatore C. Bagliardo*  
Acting  
Secretary



*Louis Roberts*  
Director, Division of Zoning

*J. F. Ashworth*  
Chief, Office of Technical Controls

SCALE IN FEET



NOTE:

-  indicates Zoning District boundary.
-  The area enclosed by the fine dotted line is proposed to be changed by establishing a C1-2 District within an existing R6 District.
-  indicates a C1-2 District.

A- 865

12 - 79 - 68

ends. 12-27-68



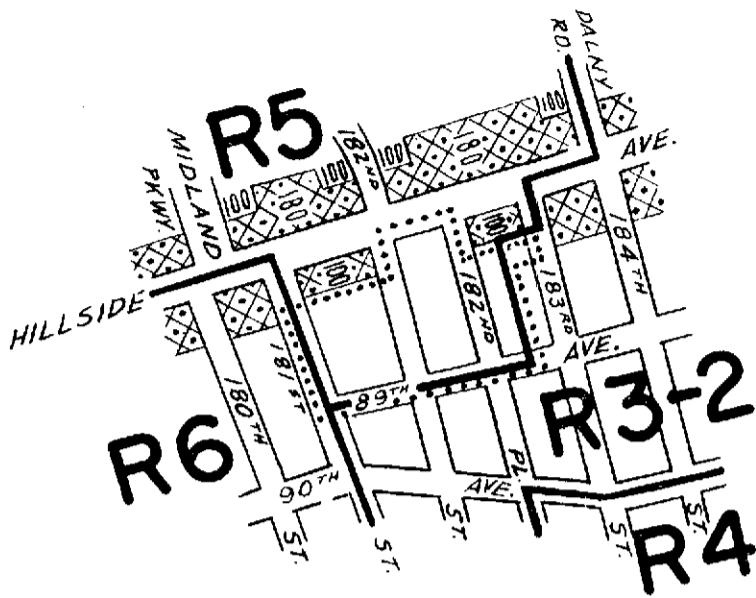

CITY PLANNING COMMISSION  
 CITY OF NEW YORK  
 DIAGRAM SHOWING PROPOSED  
 ZONING CHANGE  
 ON SECTIONAL MAP

14d  
 BOROUGH OF  
 QUEENS

New York, November 13, 1968

*Secretary C. Jagliano*  
 Secretary

*Louisa Roberti*  
 Director, Division of Zoning

*J. F. Ashworth*  
 Chief, Office of Technical Controls

SCALE IN FEET

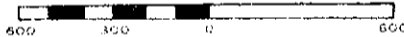

NOTE:

- indicates Zoning District boundary.
- The area enclosed by the fine dotted line is proposed to be changed by eliminating a C2-2 District within R5 and R3-2 Districts and changing an R3-2 District to an R5 District.



indicates a C2-2 District.

C.H.

A-867

F.C.  
 V.T.  
 F.C.

Dec. 19, 1968

end Jan 11, 69

C.P. 20555

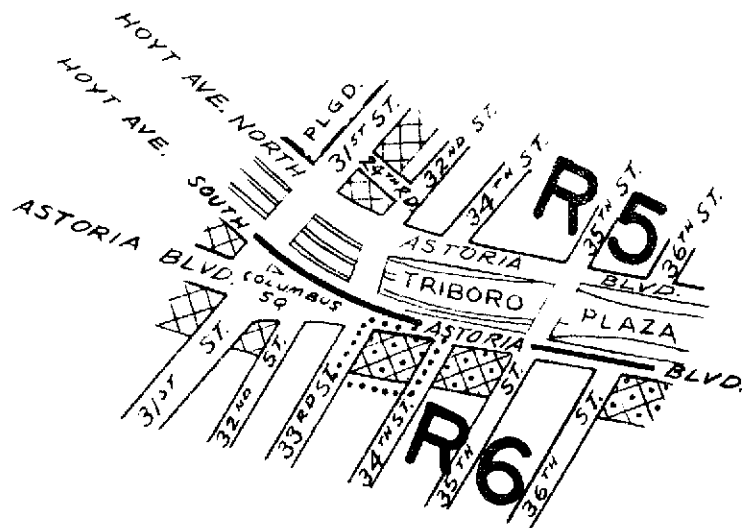

CITY PLANNING COMMISSION  
 CITY OF NEW YORK  
 DIAGRAM SHOWING PROPOSED  
 ZONING CHANGE  
 ON SECTIONAL MAP

9a  
 BOROUGH OF  
 QUEENS

*Louis Roberts*  
 Director, Division of Zoning

New York, January 15, 1969

*Leonard A. Mancusi*  
 Secretary

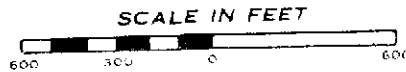

NOTE:

- indicates Zoning District boundary.
- The area enclosed by the fine dotted line is proposed to be changed by establishing a C2-2 District within an existing R6 District.
- indicates a C1-2 District.
- indicates a C2-2 District.

C.H. 111

A-871

E.D. March 13, 69  
 1

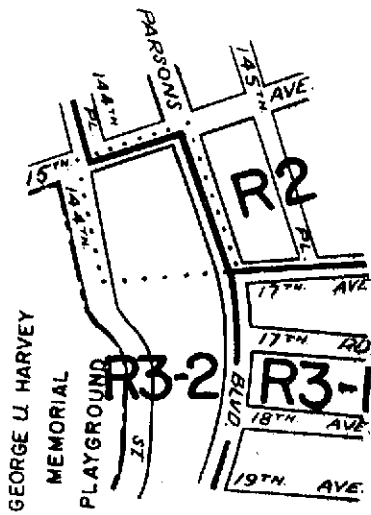

CITY PLANNING COMMISSION  
 CITY OF NEW YORK  
**DIAGRAM SHOWING PROPOSED  
 ZONING CHANGE  
 ON SECTIONAL MAPS**

**7b & 7d**  
 BOROUGH OF  
 QUEENS

New York, December 11, 1968

*Antonio C. Bagliardo*  
 Secretary

*Louie Roberti*  
 Director, Division of Zoning  
*J. F. Ashworth*  
 Chief, Office of Technical Controls

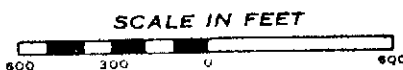

- NOTE:**
- indicates Zoning District boundary.
  - .....** The area enclosed by the fine dotted line is proposed to be changed from an R2 District to an R3-2 District.

R.C.

A-874

E.D. March 13, 69

R3-2

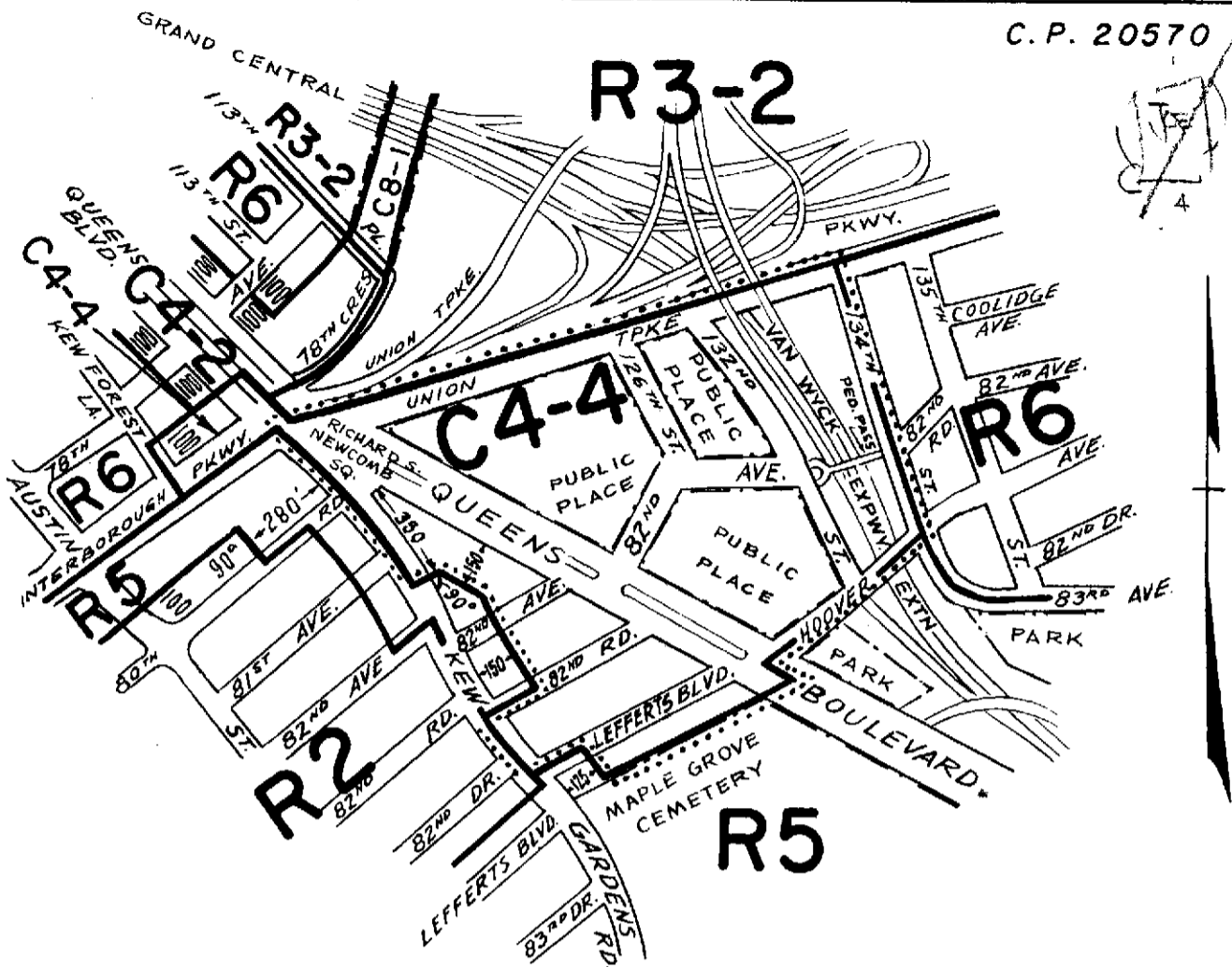

CITY PLANNING COMMISSION  
 CITY OF NEW YORK  
**DIAGRAM SHOWING PROPOSED  
 ZONING CHANGE  
 ON SECTIONAL MAP**

14b

Mod. by Bd. of Est. March 13, 1969 (Cal. No. 40).  
 Modified by C.P.C. February 19, 1969  
 New York, January 15, 1969

BOROUGH OF QUEENS

*Louis Roberti*  
 Director, Division of Zoning

*Leonard A. Mancusi*  
 Secretary

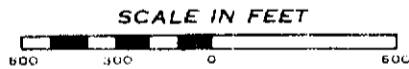

- NOTE:**
- indicates Zoning District boundary.
  - ..... The area enclosed by the fine dotted line is proposed to be changed from R5 and C1-2 Districts to a C4-4 District.

A-872

C.P. 20618  
R.C.

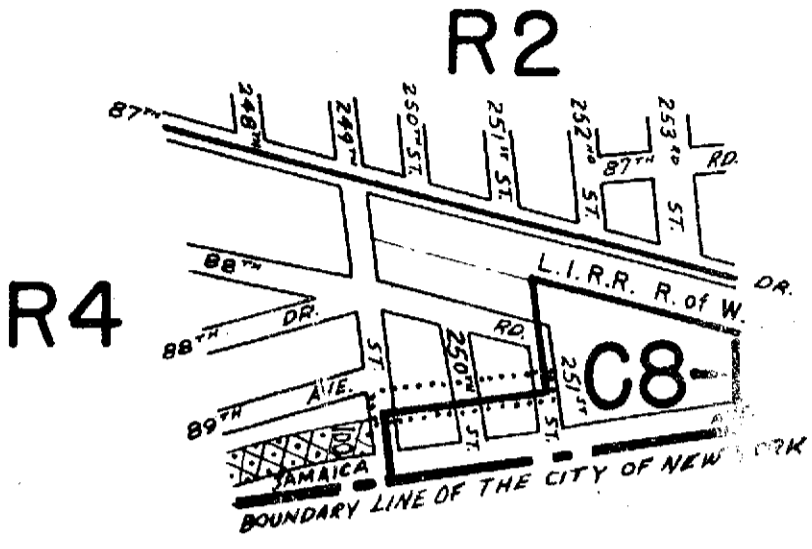

CITY PLANNING COMMISSION  
CITY OF NEW YORK  
DIAGRAM SHOWING PROPOSED  
ZONING CHANGE  
ON SECTIONAL MAP

15c  
BOROUGH OF  
QUEENS

New York, February 19, 1969

*Leonard A. Manousi*  
Secretary

*John Loewenthal*  
Act. Director, Division of Zoning

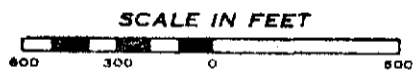

- NOTE:**
- indicates Zoning District boundary.
  - ..... The area enclosed by the fine dotted line is proposed to be changed from a C8-1 District to an R4 District.
  -  indicates a C2-2 District.

N.A.P. W/H

A-885

May 22, 69

ends 5/31/69

Rush

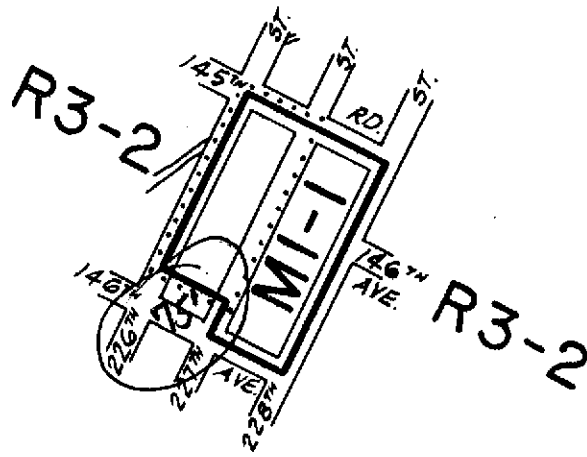

CITY PLANNING COMMISSION  
 CITY OF NEW YORK  
 DIAGRAM SHOWING PROPOSED  
 ZONING CHANGE  
 ON SECTIONAL MAP

19b

BOROUGH OF  
 QUEENS

New York, June 4, 1969

*Louise Roberts*  
 Director, Division of Zoning

*Samuel A. Mancini*  
 Secretary



NOTE:

- indicates Zoning District boundary.
- ..... The area enclosed by the fine dotted line is proposed to be changed from an R3-2 District to an MI-1 District.

*HC*

A-947

May 7, 1970

5/8/70 Rush

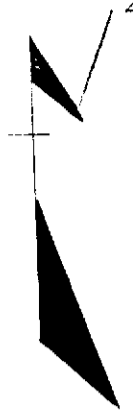
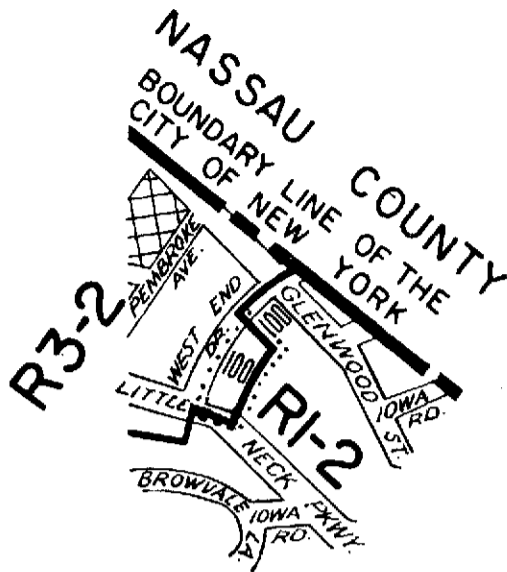

CITY PLANNING COMMISSION  
 CITY OF NEW YORK  
 DIAGRAM SHOWING PROPOSED  
 ZONING CHANGE  
 ON SECTIONAL MAP

11c

BOROUGH OF  
 QUEENS

*Julius Lowenthal*  
 Acting Director, Division of Zoning

New York, April 16, 1969

*Leonard A. Mancusi*  
 Secretary

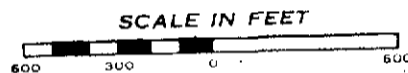

NOTE:

- indicates Zoning District boundary.
- The area enclosed by the fine dotted line is proposed to be changed from an RI-2 District to an R3-2 District.
- indicates a C1-2 District.

✓ OK  
 F.C.

A-895  
 July 24, 69  
 ends Sept 16, 69

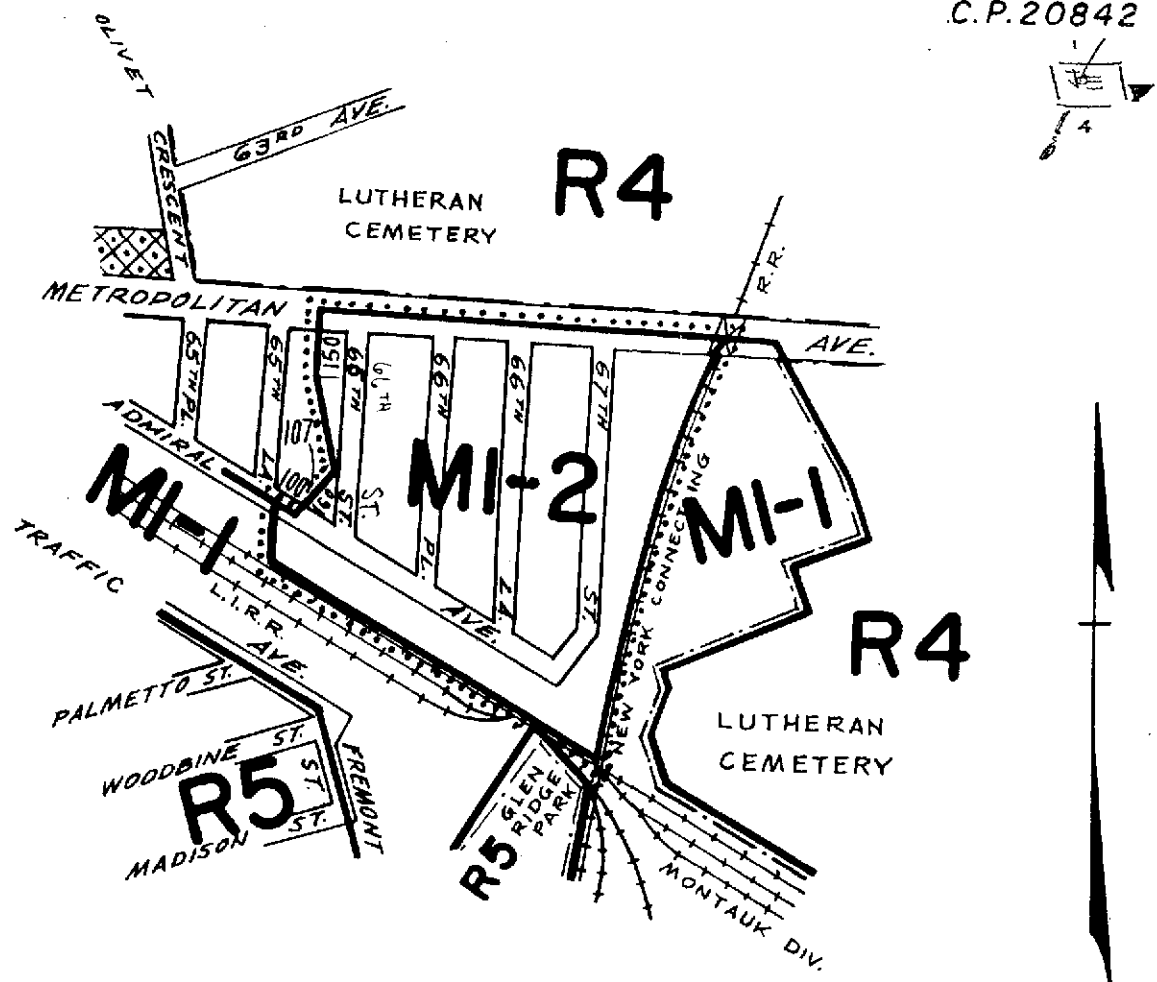

CITY PLANNING COMMISSION  
 CITY OF NEW YORK  
**DIAGRAM SHOWING PROPOSED  
 ZONING CHANGE  
 ON SECTIONAL MAP**

**13d**  
 BOROUGH OF  
 QUEENS

New York, August 13, 1969

*Louis Roberts*  
 Director, Division of Zoning

*Jananda A. Monansi*  
 Secretary



- NOTE:**
- indicates Zoning District boundary.
  - The area enclosed by the fine dotted line is proposed to be changed from an MI-1 District and an R4 District to an MI-2 District.
  - indicates a C2-2 District.

C.H. 17

A-909  
 OJ 9, 69



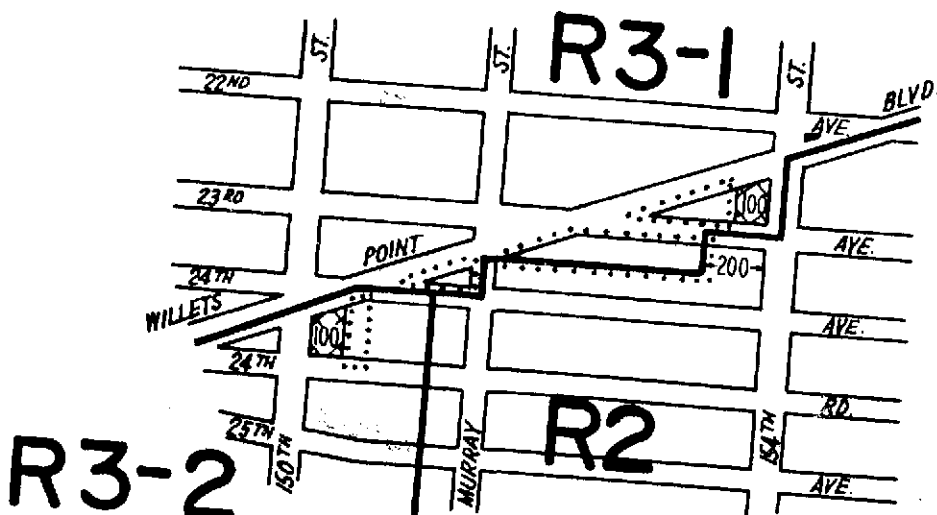
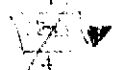

CITY PLANNING COMMISSION  
 CITY OF NEW YORK  
**DIAGRAM SHOWING PROPOSED  
 ZONING CHANGE  
 ON SECTIONAL MAP  
 10c**  
 BOROUGH OF  
 QUEENS

*Louis Roberti*  
 Director, Division of Zoning

New York, September 10, 1969

*Joseph J. ...*  
 Secretary



- NOTE:**
- indicates Zoning District boundary.
  - The area enclosed by the fine dotted line is proposed to be changed by eliminating CI-2 Districts from within R3-1 and R3-2 Districts.
  - indicates CI-2 District.

C.H. ... / AC

A-916-

Nov 13, 69  
 ends 11, 22, 69

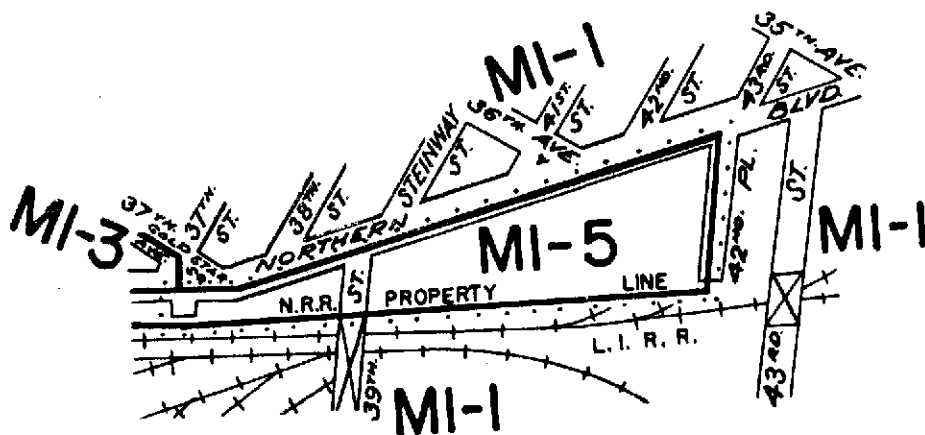

CITY PLANNING COMMISSION  
 CITY OF NEW YORK  
 DIAGRAM SHOWING PROPOSED  
 ZONING CHANGE  
 ON SECTIONAL MAP

9b

BOROUGH OF  
QUEENS

*Louie Roberts*  
 Director, Division of Zoning

New York, September 10, 1969

*Joseph A. Mancini*  
 Secretary

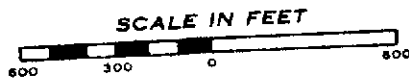

**NOTE:**  
 ————— indicates Zoning District boundary.  
 ..... The area enclosed by the fine dotted line is proposed to be changed from an MI-1 District to an MI-5 District.

A-914

F.D. Oct 23, 69

11-8-69

14  
 2  
 26  
 27

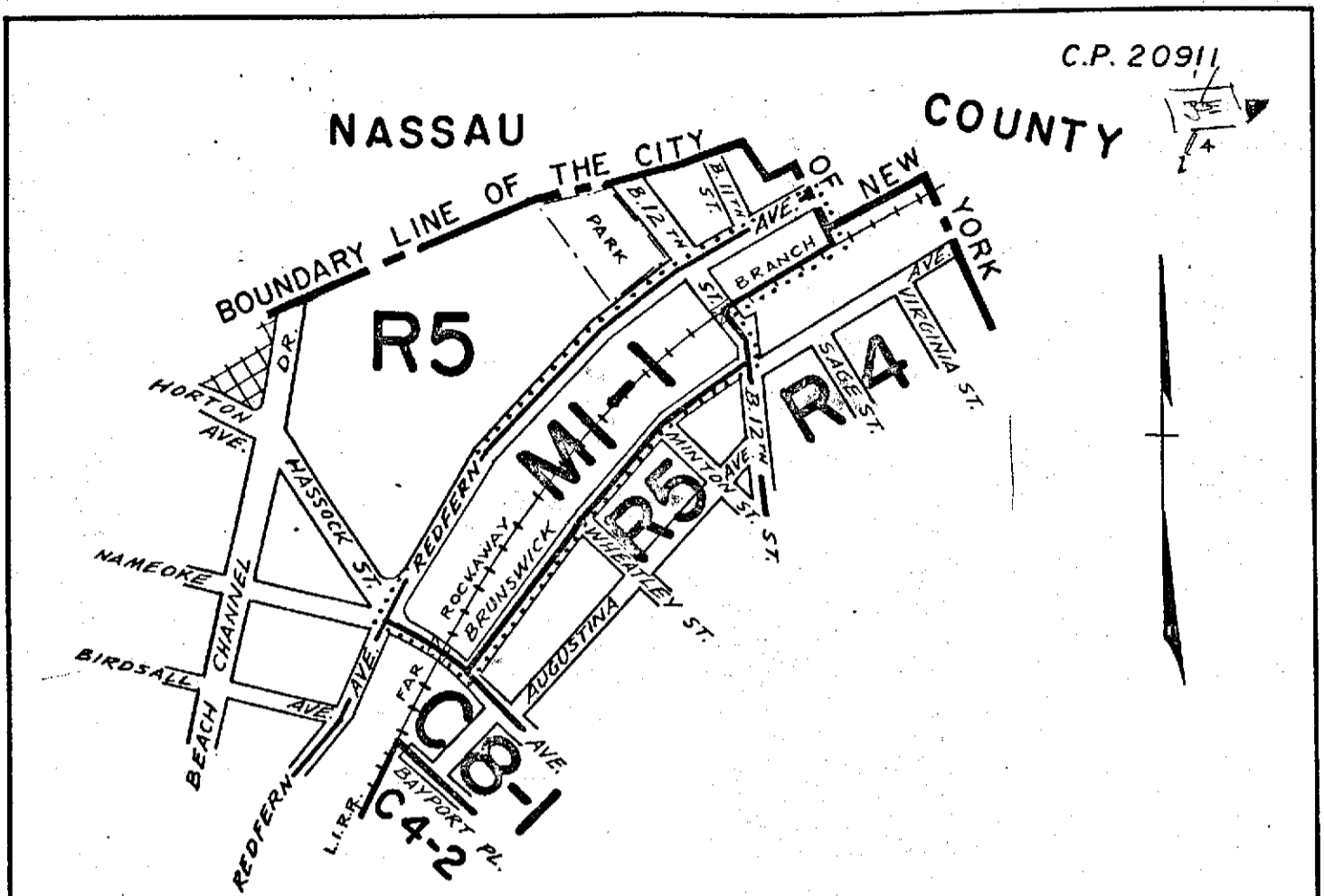

CITY PLANNING COMMISSION  
 CITY OF NEW YORK  
 DIAGRAM SHOWING PROPOSED  
 ZONING CHANGE  
 ON SECTIONAL MAP

**25b**  
 BOROUGH OF  
 QUEENS

New York, September 24, 1969

*Leonard A. Marini*  
 Secretary

*Louis Roberts*  
 Director, Division of Zoning



- NOTE:**
- indicates Zoning District boundary.
  - The area enclosed by the fine dotted line is proposed to be changed from a C4-2 District to an MI-1 District.
  - indicates a C1-2 District.

C.H. 1/16 2/2/69

A - 923

Dec. 18, 69

ends 11/22/69

F.C.

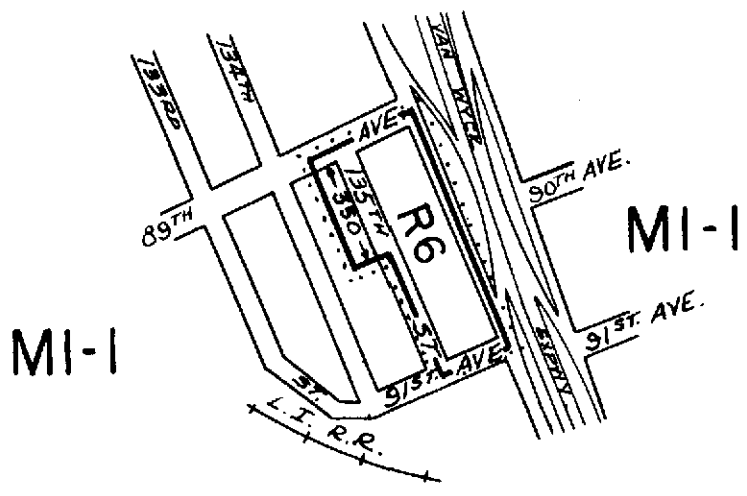

CITY PLANNING COMMISSION  
CITY OF NEW YORK  
DIAGRAM SHOWING PROPOSED  
ZONING CHANGE  
ON SECTIONAL MAP  
14d

BOROUGH OF  
QUEENS

*Louie Roberts*  
Director, Division of Zoning

Modified January 21, 1970  
New York, September 24, 1969

*Leonard A. Monaci*  
Secretary

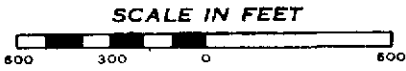

**NOTE:**  
———— indicates Zoning District boundary.  
..... The area enclosed by the fine dotted line is proposed to be changed from an MI-1 District to an R6 District.

A.J.P. 7/11/69

A - ~~20919~~ F.C.

A - 932

Feb. 13, 70

Feb. 22, 70 Rusl ?

C. P. 20936

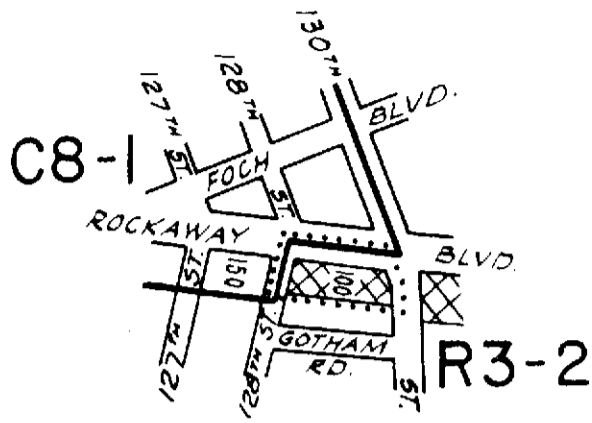
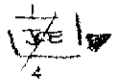

CITY PLANNING COMMISSION  
CITY OF NEW YORK  
**DIAGRAM SHOWING PROPOSED  
ZONING CHANGE  
ON SECTIONAL MAP**  
**18c**  
BOROUGH OF  
QUEENS

New York, October 22, 1969

*Samuel M. Marcus*  
Secretary

*Louis Roberti*  
Director, Division of Zoning

SCALE IN FEET



**NOTE:**

- indicates Zoning District boundary.
- The area enclosed by the fine dotted line is proposed to be changed from a C8-1 District to R3-2 and C1-2 Districts.
- indicates a C1-2 District.

A - 926

Jan 8, 70

12/11/69  
64  
110

110

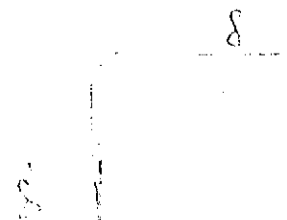

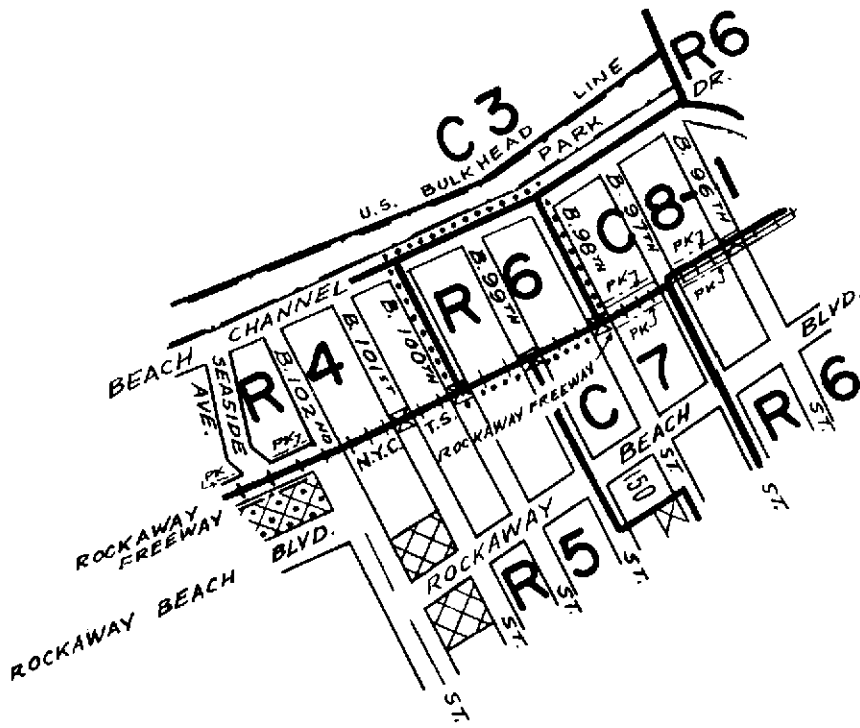





CITY PLANNING COMMISSION  
 CITY OF NEW YORK  
**DIAGRAM SHOWING PROPOSED  
 ZONING CHANGE  
 ON SECTIONAL MAP  
 30c**  
 BOROUGH OF  
 QUEENS

New York, November 26, 1969

*Louis Roberts*  
 Director, Division of Zoning



- NOTE:**
-  indicates Zoning District boundary.
  -  The area enclosed by the fine dotted line is proposed to be changed from an R4 District to an R6 District.
  -  indicates a C1-2 District.
  -  indicates a C2-2 District.

929  
 2/13  
 Jan 8, 70

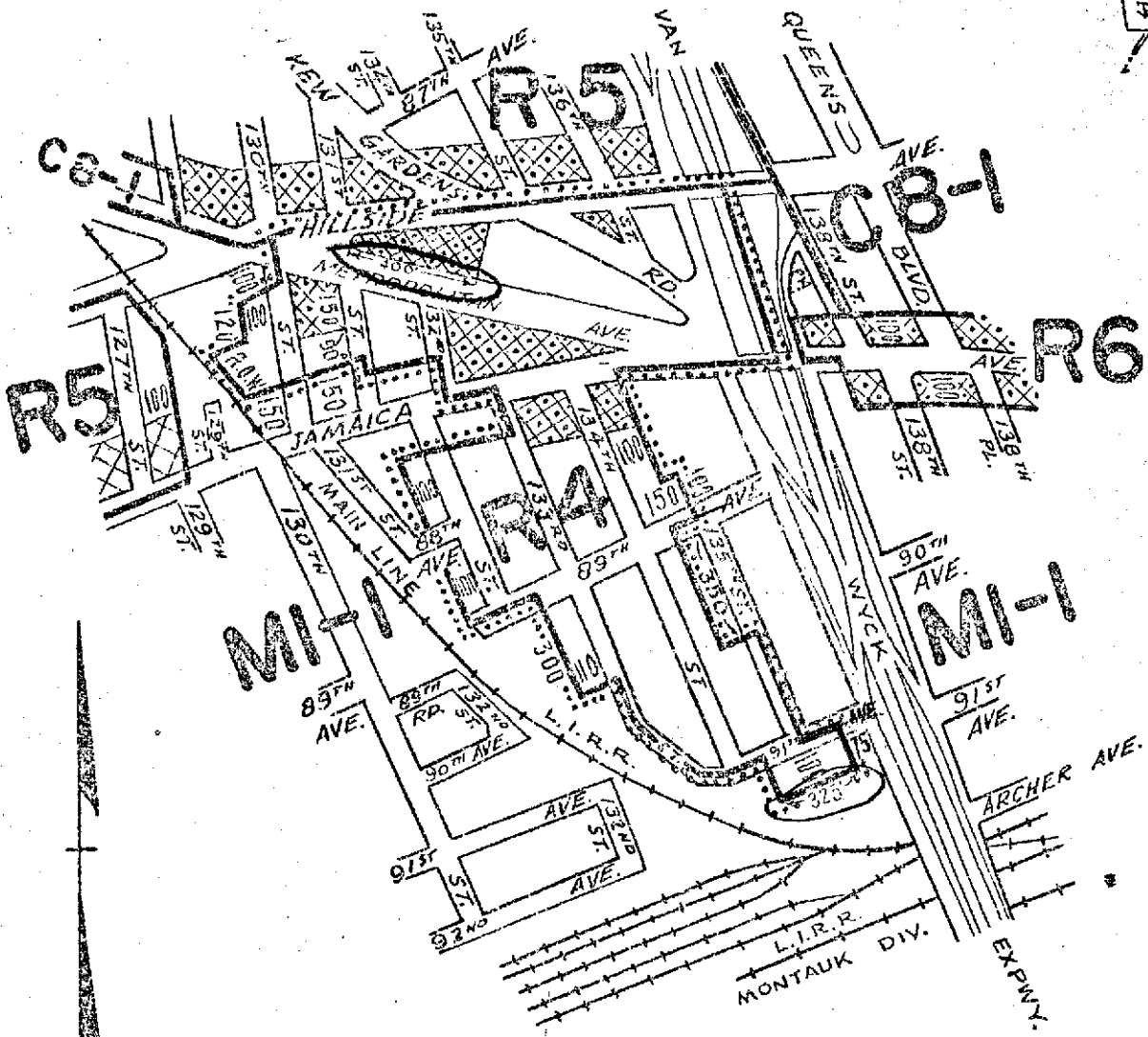
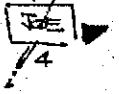

CITY PLANNING COMMISSION  
 CITY OF NEW YORK  
 DIAGRAM SHOWING PROPOSED  
 ZONING CHANGE  
 ON SECTIONAL MAP

14d

BOROUGH OF  
QUEENS



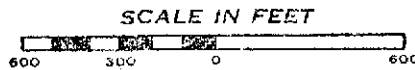

*Louis Roberti*  
 Director, Division of Zoning

New York, January 21, 1970

Secretary



NOTE:

-  indicates Zoning District boundary.
-  The area enclosed by the fine dotted line is proposed to be changed from an MI-1 District to an R4 District and establishing C2-2 Districts therein.
-  indicates C1-2 District.
-  indicates C2-2 District.

G.H.

A-941  
 April 16, 70

C. P. 21070

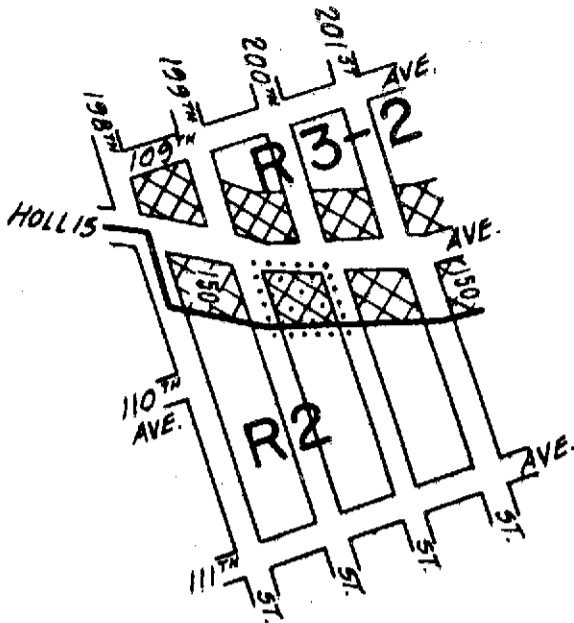

CITY PLANNING COMMISSION  
 CITY OF NEW YORK  
 DIAGRAM SHOWING PROPOSED  
 ZONING CHANGE  
 ON SECTIONAL MAP

15b  
 BOROUGH OF  
 QUEENS

New York, February 4, 1970

*Louis Roberts*  
 Director, Division of Zoning



- NOTE:**
- indicates Zoning District boundary.
  - ..... The area enclosed by the fine dotted line is proposed to be changed from a C1-2 District to a C2-2 District.
  - ⊠ indicates a C1-2 District.
  - ⊞ indicates a C2-2 District.

*del by HC 917.*

*A-942*

*F.O.*

*April 16, 70*



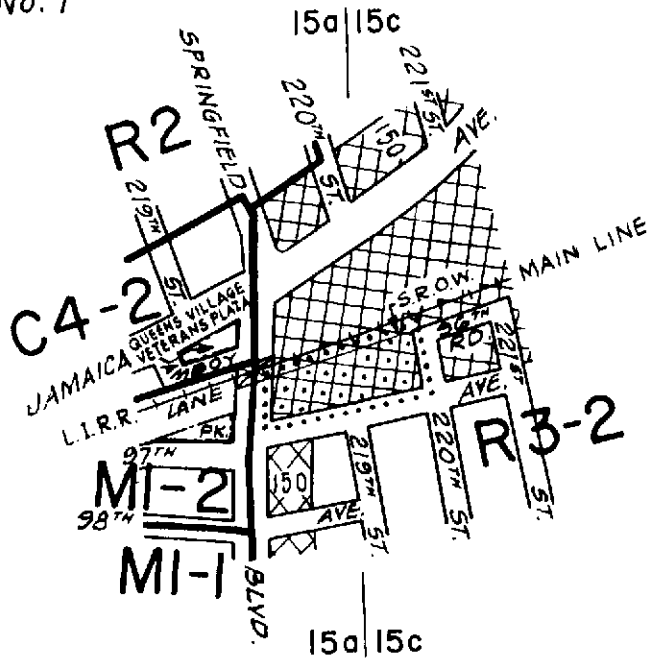

CITY PLANNING COMMISSION  
 CITY OF NEW YORK  
 DIAGRAM SHOWING PROPOSED  
 ZONING CHANGE  
 ON SECTIONAL MAPS

15a & 15c  
 BOROUGH OF  
 QUEENS

*Louis Roberti*  
 Director, Division of Zoning

New York, April 29, 1970

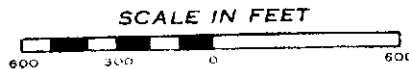

NOTE:

- indicates Zoning District boundary.
- The area enclosed by the fine dotted line is proposed to be changed from a C1-2 District to a C2-2 District within an existing R3-2 District.
- indicates a C1-2 District.
- indicates a C2-2 District.

*H.C.*

*OK  
F.C.*

*A-953*

*June 18, 1970*

*ends June 26, 70*

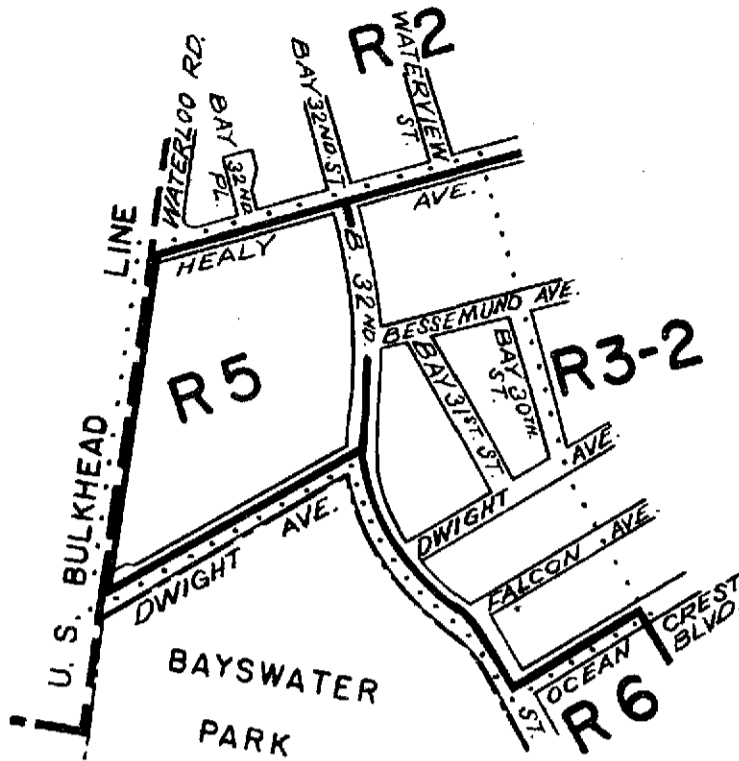
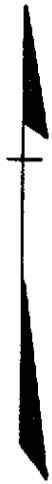

CITY PLANNING COMMISSION  
 CITY OF NEW YORK  
**DIAGRAM SHOWING PROPOSED  
 ZONING CHANGE  
 ON SECTIONAL MAP**

31 a  
 BOROUGH OF  
 QUEENS

Modified August 11, 1971  
 New York, April 29, 1970

*Louis Roberts*  
 Director, Division of Zoning

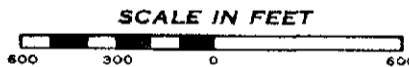

**NOTE:**  
 ————— indicates Zoning District boundary.  
 ..... The area enclosed by the fine dotted line is proposed to be changed from  
 an R6 District to R5 and R3-2 Districts.

APPROVED BY BOARD OF ESTIMATE

CALENDAR # 27

DATE 9/16/71

AMDT # 1018

EFF. 9/16/71

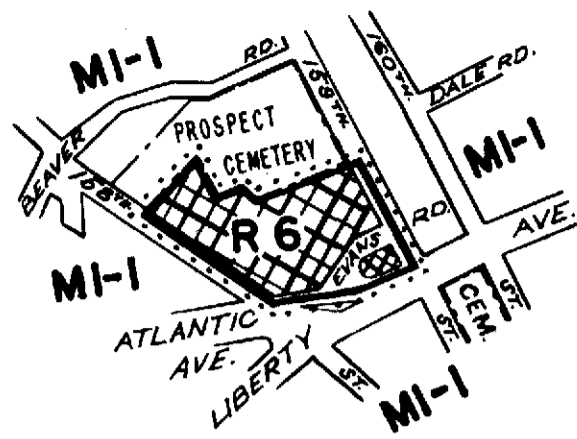

get mapping  
Print from  
down



CITY PLANNING COMMISSION  
CITY OF NEW YORK  
DIAGRAM SHOWING PROPOSED  
ZONING CHANGE  
ON SECTIONAL MAP



14 d

BOROUGH OF  
QUEENS

*Louis Roberti*  
Director, Division of Zoning

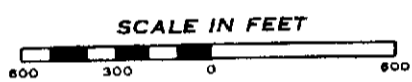
New York, March 4, 1970



- NOTE:**
-  indicates Zoning District boundary.
  -  The area enclosed by the fine dotted line is proposed to be changed from M3-1 and MI-1 Districts to R6 and CI-4 Districts.
  -  Indicates a CI-4 District.

CC G.G.

A-949

OK

May 21-70

ends May 8 70



R3-2

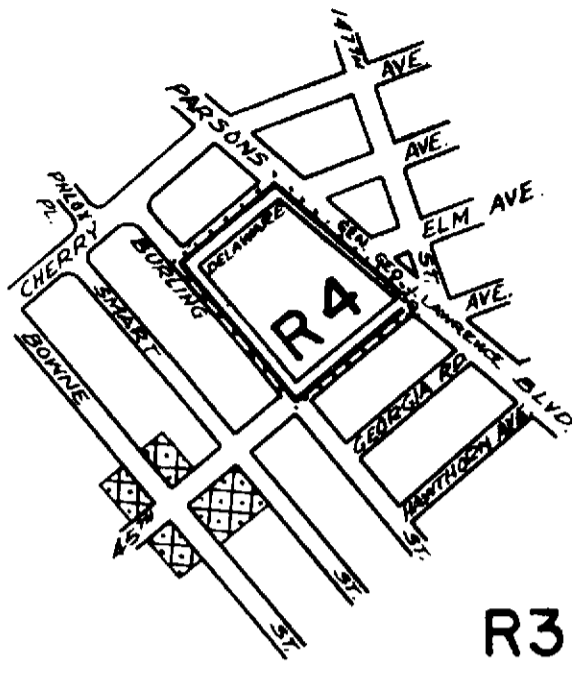



R3-2

CITY PLANNING COMMISSION  
CITY OF NEW YORK  
DIAGRAM SHOWING PROPOSED  
ZONING CHANGE  
ON SECTIONAL MAP  
10d  
BOROUGH OF  
QUEENS

*Louis Roberts*  
Director, Division of Zoning

New York, June 24, 1970



- NOTE:
-  indicates Zoning District boundary.
  -  The area enclosed by the fine dotted line is proposed to be changed from an R3-2 District to an R4 District.
  -  indicates a C2-2 District.

A.J.P.

A-967

E.D. Aug. 20, 70

Ext. 12, 70

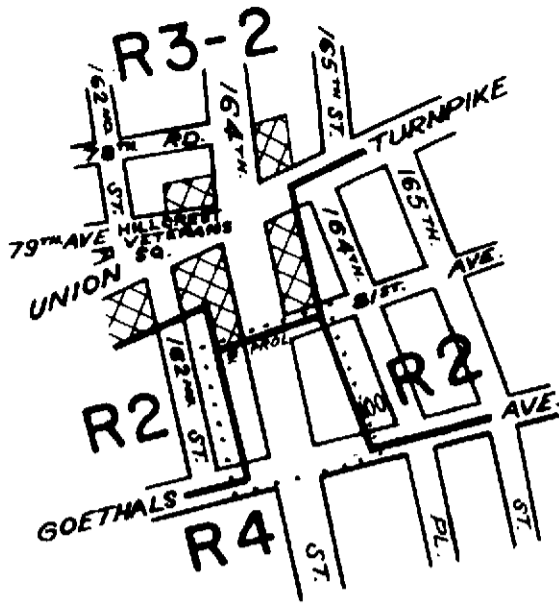
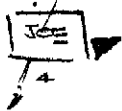



CITY PLANNING COMMISSION  
CITY OF NEW YORK  
DIAGRAM SHOWING PROPOSED  
ZONING CHANGE  
ON SECTIONAL MAP  
14c

BOROUGH OF  
QUEENS

*Louis Roberti*  
Director, Division of Zoning

New York, July 15, 1970

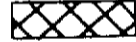

- NOTE:**
-  indicates Zoning District boundary.
  -  The area enclosed by the fine dotted line is proposed to be changed from an R2 District to an R4 District.
  -  indicates a C1-2 District.

RC

A-971

E.P.

Sept 17, 70

1700  
 1600  
 200  
 1400  
 10  
 1410

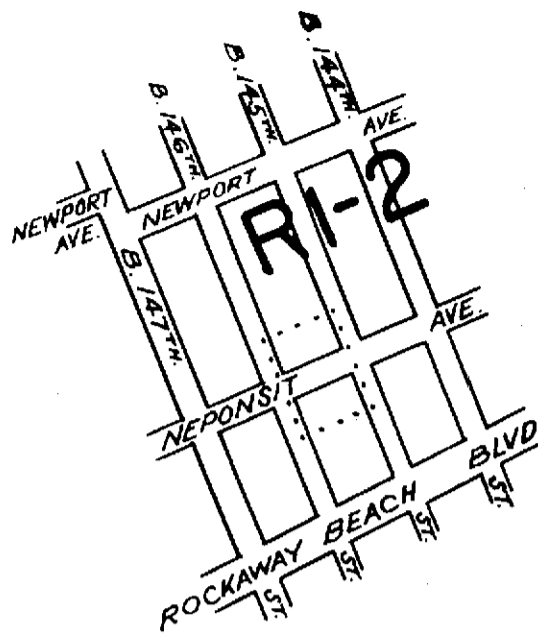

CITY PLANNING COMMISSION  
 CITY OF NEW YORK  
**DIAGRAM SHOWING PROPOSED  
 ZONING CHANGE  
 ON SECTIONAL MAP  
 30 b**

BOROUGH OF  
 QUEENS

New York, December 9, 1970

*Louis Roberti*  
 Director, Division of Zoning

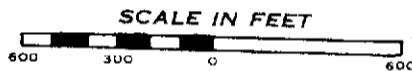

- NOTE:**
- indicates Zoning District boundary.
  - ..... The area enclosed by the fine dotted line is proposed to be changed by eliminating a C1-2 District from an existing R1-2 District.

A - 989

Jan 28, 1971

ends Feb. 19, 1971

OK ✓

C.P. 21434

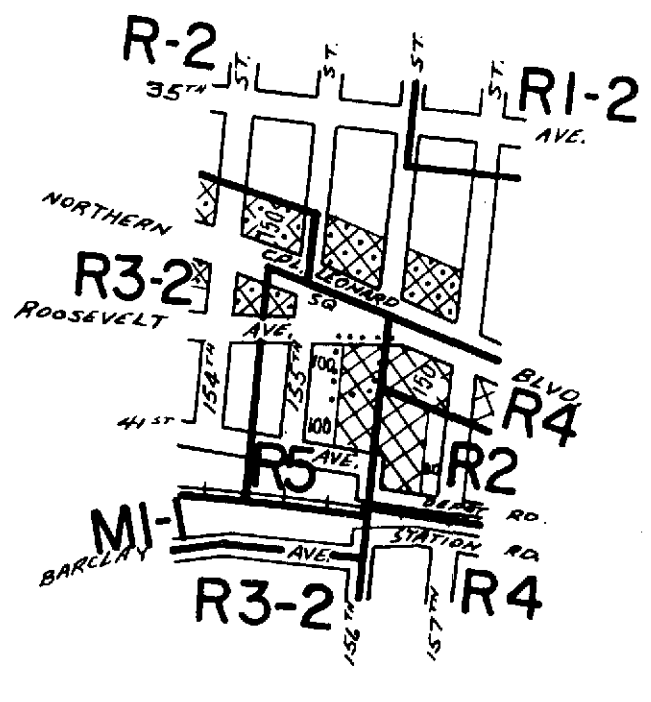

CITY PLANNING COMMISSION  
 CITY OF NEW YORK  
 DIAGRAM SHOWING PROPOSED  
 ZONING CHANGE  
 ON SECTIONAL MAP

10c  
 BOROUGH OF  
 QUEENS

*Louis Roberti*  
 Director, Division of Zoning

New York, December 9, 1970

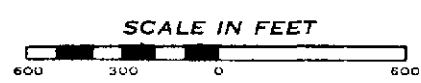

- NOTE:**
- indicates Zoning District boundary.
  - ..... The area enclosed by the fine dotted line is proposed to be changed by establishing a C1-2 District within an existing R5 District.
  - indicates a C1-2 District.
  - indicates a C2-2 District.

n.a.p.

*Eff Date 3/11/71 A-993*

# EXAGGERATED SKETCH

(AREA ENCLOSED BY FINE DOTTED LINE)

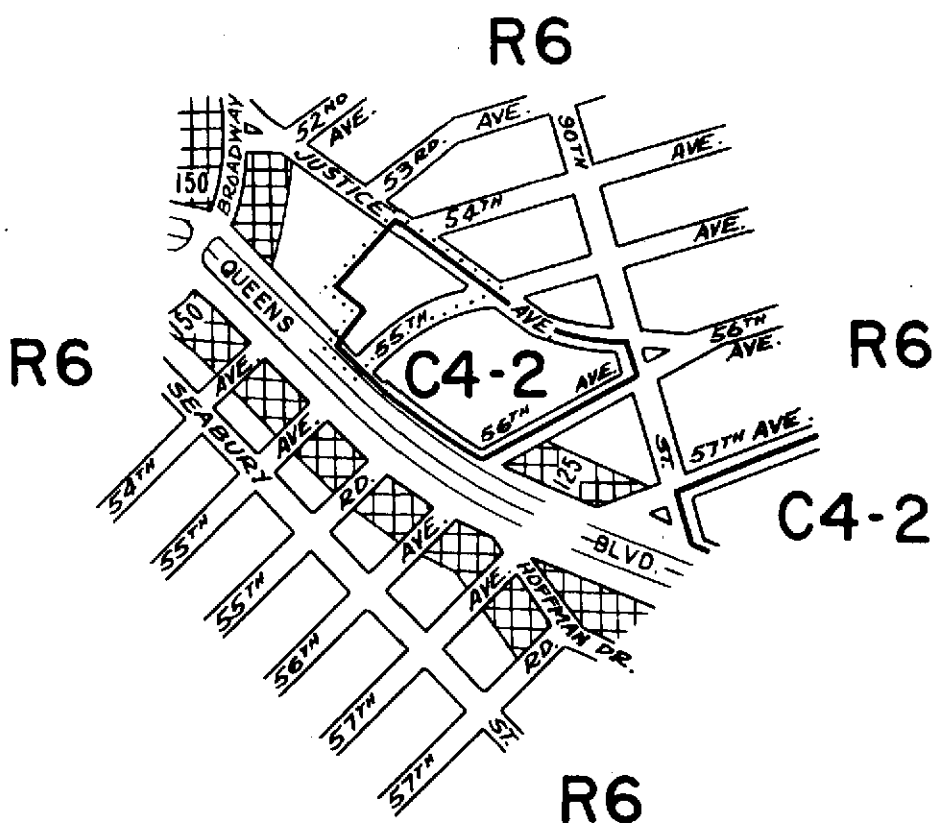
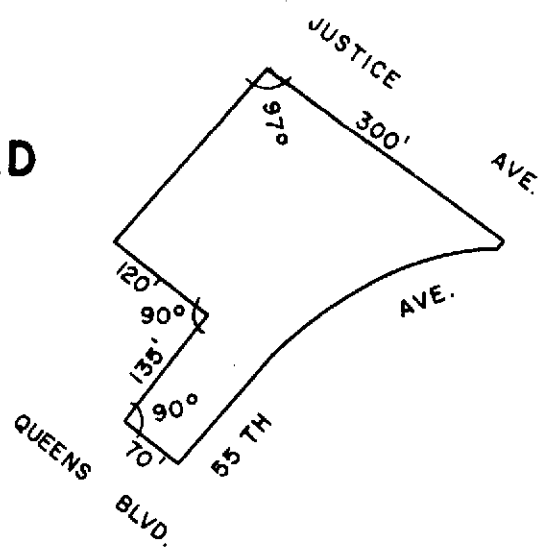

CITY PLANNING COMMISSION  
 CITY OF NEW YORK  
**DIAGRAM SHOWING PROPOSED ZONING CHANGE ON SECTIONAL MAP**

13c

BOROUGH OF QUEENS

New York, March 3, 1971

*Louis Roberts*  
 Director, Division of Zoning



**NOTE:**

- indicates Zoning District boundary.
- The area enclosed by the fine dotted line is proposed to be changed from an R6 District to a C4-2 District.
- indicates a C4-2 District.

A.J.P. *HC*

APPROVED BY BOARD OF ESTIMATE

CALENDAR # AMDT # 1080

DATE 9/14/72



✓ OK

C.P. 21491

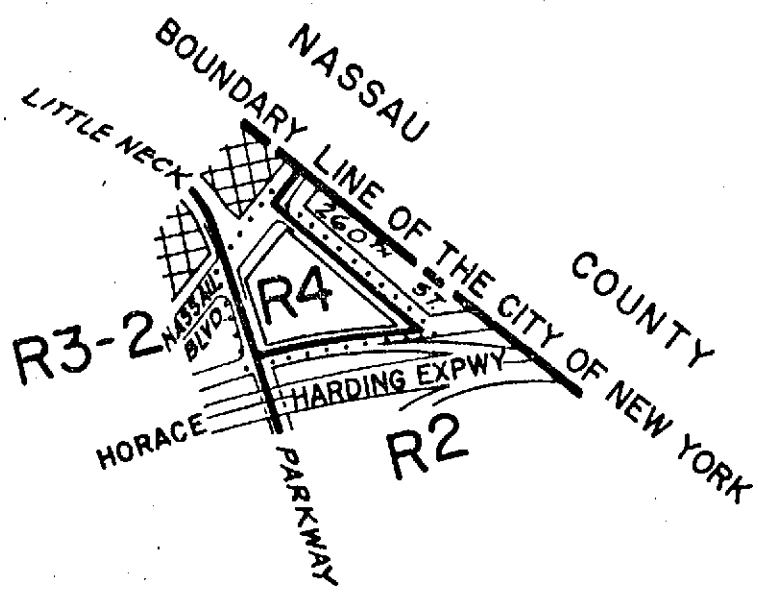

CITY PLANNING COMMISSION  
 CITY OF NEW YORK  
**DIAGRAM SHOWING PROPOSED  
 ZONING CHANGE  
 ON SECTIONAL MAP**

**11c**  
 BOROUGH OF  
 QUEENS

New York, February 3, 1971

*J. Louis ...*  
 Acting Director, Division of Zoning

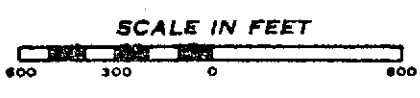

**NOTE:**

- indicates Zoning District boundary.
- The area enclosed by the fine dotted line is proposed to be changed from an R2 District to an R4 District.
- indicates a C1-2 District.

*etc. 11c*

*Eff. Date 3/11/71 A-997*

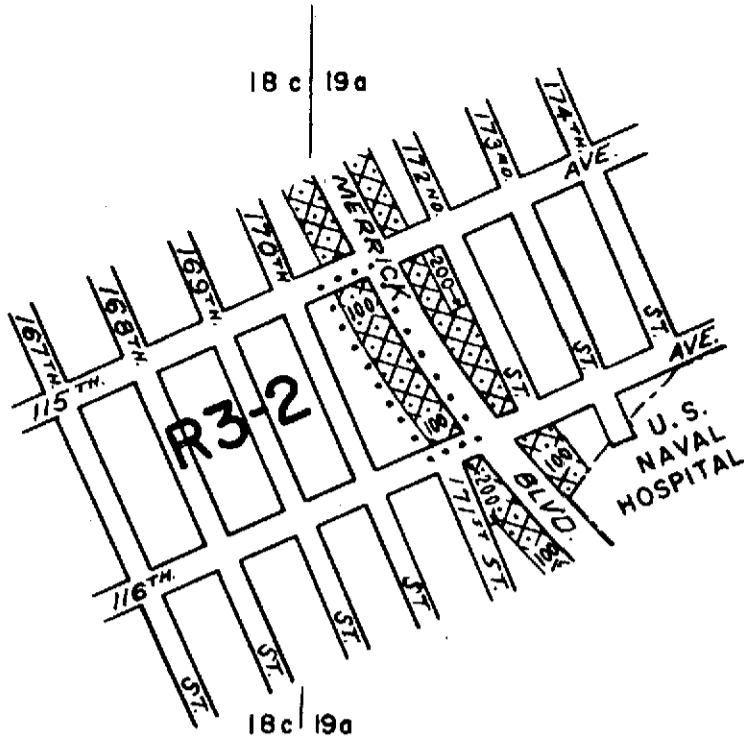

CITY PLANNING COMMISSION  
 CITY OF NEW YORK  
**DIAGRAM SHOWING PROPOSED  
 ZONING CHANGE  
 ON SECTIONAL MAP  
 19a**

BOROUGH OF  
 QUEENS

New York, May 12, 1971

*Louis Roberti*  
 Director, Division of Zoning  
*Avin Fruchtmann*  
 Chief Engineer



- NOTE:**
- indicates Zoning District boundary.
  - The area enclosed by the fine dotted line is proposed to be changed by establishing a C2-2 District within an existing R3-2 District.
  - indicates a C2-2 District.

APPROVED BY BOARD OF ESTIMATE

CALENDAR # AMDT # 1028

DATE 11/11/71

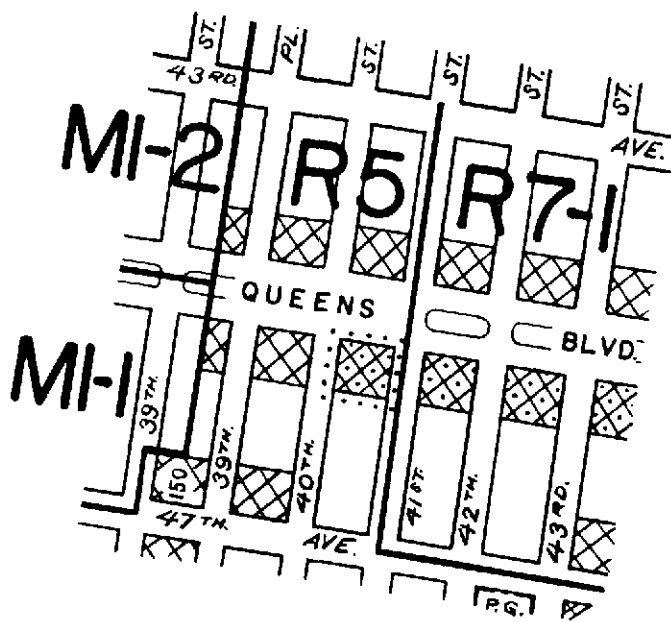

CITY PLANNING COMMISSION  
 CITY OF NEW YORK  
**DIAGRAM SHOWING PROPOSED  
 ZONING CHANGE  
 ON SECTIONAL MAP  
 9 b**  
 BOROUGH OF  
 QUEENS

New York, March 3, 1971

*Louis Roberts*  
 Director, Division of Zoning



**NOTE:**

- indicates Zoning District boundary.
- The area enclosed by the fine dotted line is proposed to be changed from an existing C1-2 District to a C2-2 District.
- indicates a C1-2 District.
- indicates a C2-2 District.

*approved 5/20/71  
 Amndt. No 1002*

4 1/2"

C.P. 21521

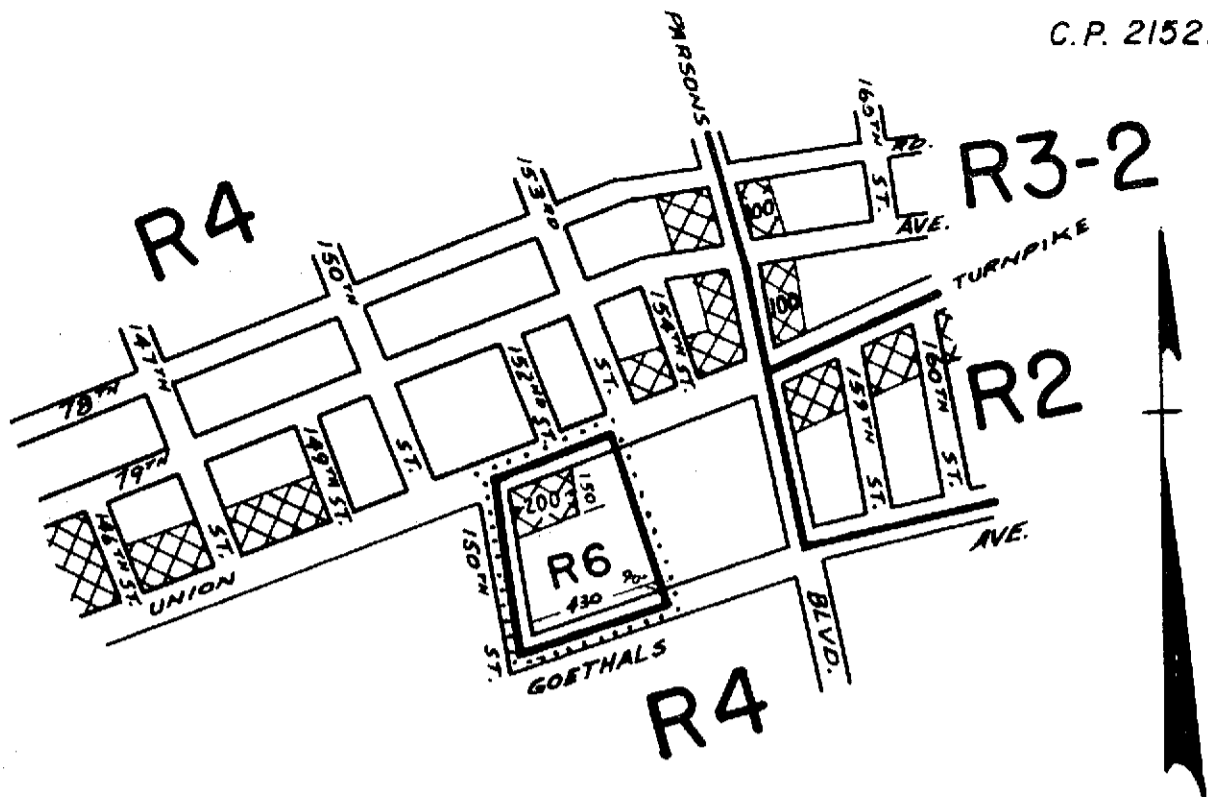

CITY PLANNING COMMISSION  
 CITY OF NEW YORK  
**DIAGRAM SHOWING PROPOSED  
 ZONING CHANGE  
 ON SECTIONAL MAP**

14c



BOROUGH OF  
 QUEENS

Modified by C.P.C. May 26, 1971  
 New York, February 17, 1971

*Louis Roberti*  
 Director, Division of Zoning



**NOTE:**

-  indicates Zoning District boundary.
-  The area enclosed by the fine dotted line is proposed to be changed from an R4 District to an R6 District and establishing a CI-2 District within a proposed R6 District.
-  indicates CI-2 District.

W.A.P.

60.5

*apt B of E 7/2-7/71*  
*U = 1008*

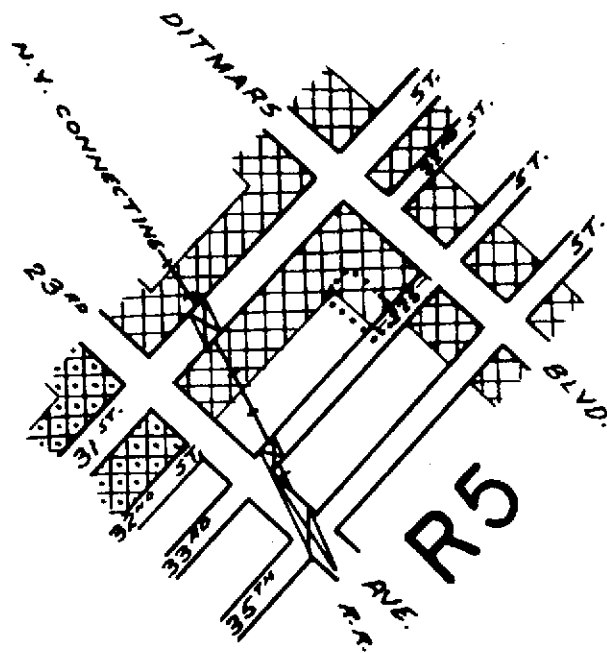

CITY PLANNING COMMISSION  
 CITY OF NEW YORK  
**DIAGRAM SHOWING PROPOSED  
 ZONING CHANGE  
 ON SECTIONAL MAP  
 9c**  
 BOROUGH OF  
 QUEENS

New York, March 17, 1971

*Louie Roberts*  
 Director, Division of Zoning  
*Armin Fuchtmann*  
 Chief Engineer



- NOTE:**
- indicates Zoning District boundary.
  - The area enclosed by the fine dotted line is proposed to be changed by establishing a C1-2 District within an existing R5 District.
  - indicates a C1-2 District.
  - indicates a C2-2 District.

N.A.P.

*Approved 5/20/71*  
*Amend. No. 1003*

4 1/2"

C.P. 21571

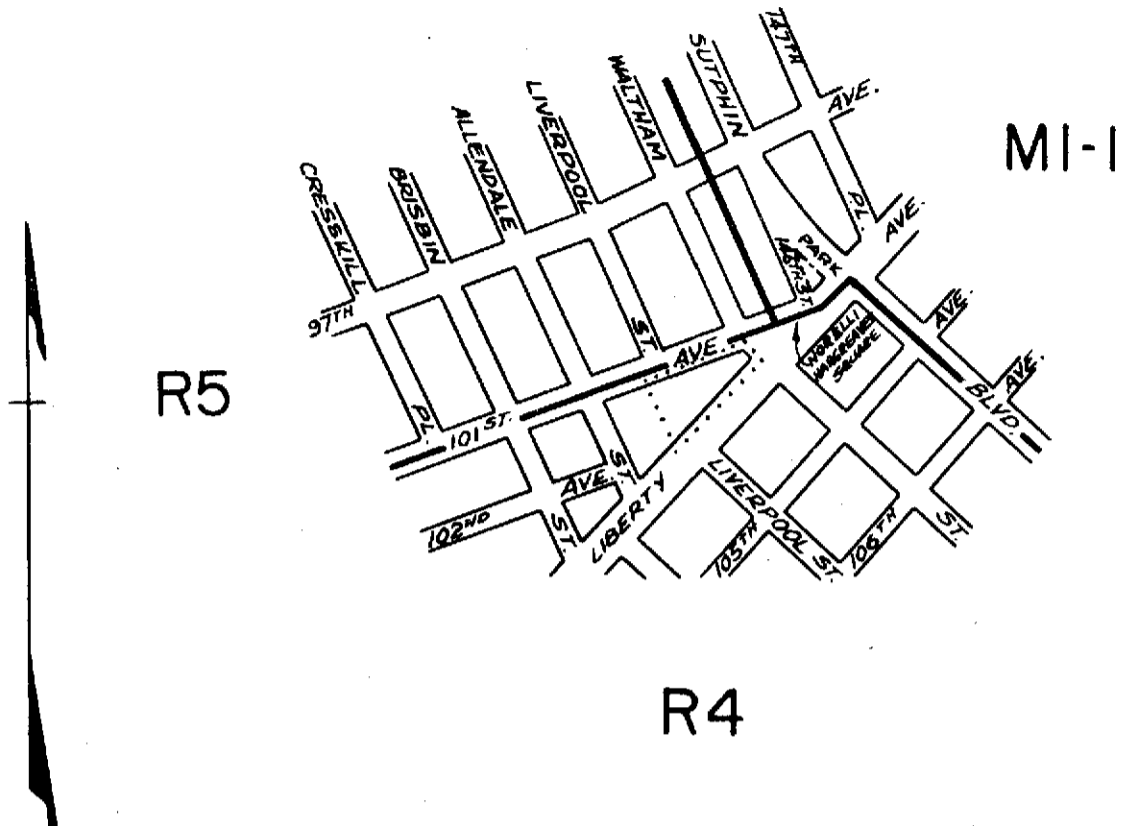

C.P. 21571

CITY PLANNING COMMISSION  
 CITY OF NEW YORK  
**DIAGRAM SHOWING PROPOSED  
 ZONING CHANGE  
 ON SECTIONAL MAP**

**14d**  
 BOROUGH OF  
 QUEENS

New York, March 31, 1971

*Julius Spector*  
 Acting Director, Division of Zoning  
*John J. Mollen*  
 CHIEF ENGINEER



**NOTE:**

- indicates Zoning District boundary.
- The area enclosed by the fine dotted line is proposed to be changed by establishing an R4 District on the site of a former Park.

A.J.P.

*Amendment # 1005*  
*app. June 17, 1971*

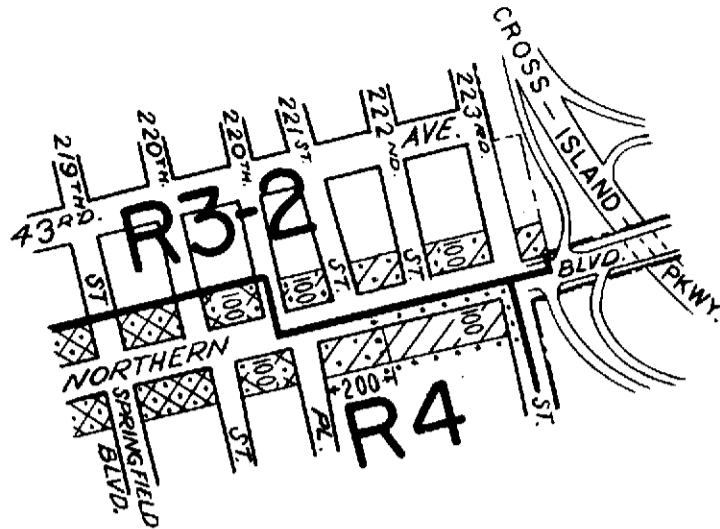

CITY PLANNING COMMISSION  
 CITY OF NEW YORK  
**DIAGRAM SHOWING PROPOSED  
 ZONING CHANGE  
 ON SECTIONAL MAP  
 11a**

BOROUGH OF  
 QUEENS

New York, May 26, 1971

*Louis Roberts*  
 Director, Division of Zoning  
*John Froehner*  
 Chief Engineer



**NOTE:**

- indicates Zoning District boundary.
- The area enclosed by the fine dotted line is proposed to be changed by establishing a C1-1 District within an R4 District.
- indicates a C1-1 District.
- indicates a C2-1 District.
- indicates a C2-2 District.

*app. R of E. 7/22/71*

*Am. dt # 1009*

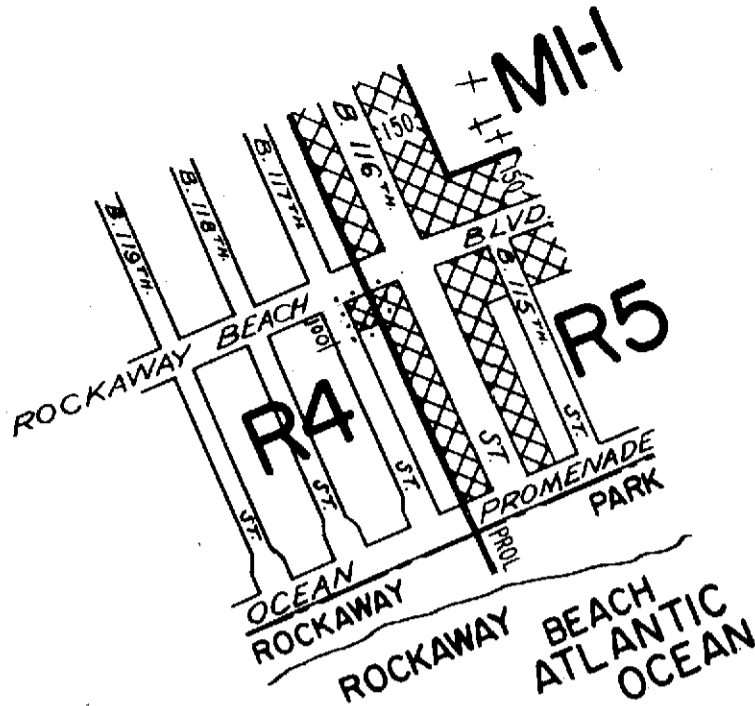

CITY PLANNING COMMISSION  
 CITY OF NEW YORK  
**DIAGRAM SHOWING PROPOSED  
 ZONING CHANGE  
 ON SECTIONAL MAP**



**30 b**  
 BOROUGH OF  
 QUEENS

New York, **June 9, 1971**

*Louis Roberti, P.E.*  
 Director, Division of Zoning  
*Irvin Friedman*  
 Chief Engineer



**NOTE:**

-  indicates Zoning District boundary.
-  The area enclosed by the fine dotted line is proposed to be changed by establishing a C1-2 District within an existing R4 District.
-  indicates a C1-2 District.

*apt B of E 7/22/71*  
*Amend # 1013*



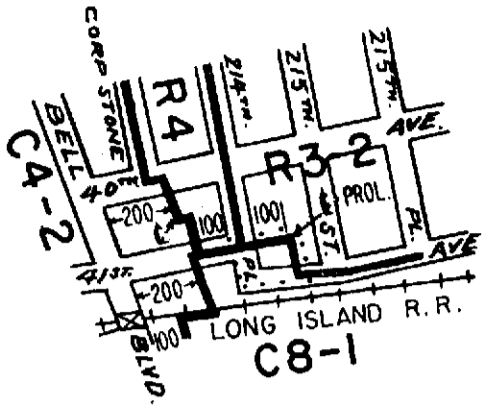

CITY PLANNING COMMISSION  
CITY OF NEW YORK  
DIAGRAM SHOWING PROPOSED  
ZONING CHANGE  
ON SECTIONAL MAP

11a  
BOROUGH OF  
QUEENS

New York, September 8, 1971

*Julius Specter PE*  
ACTING Director, Division of Zoning

*Jim Fendler PE*  
Chief Engineer



- NOTE:**
- indicates Zoning District boundary.
  - The area enclosed by the fine dotted line is proposed to be changed from an R3-2 District to a C8-1 District.

*[Handwritten signature]*

**APPROVED BY BOARD OF ESTIMATE**

CALENDAR # 109

DATE 10/28/71

AMDT ~~1027~~ # 1027

~~EST. [unclear]~~

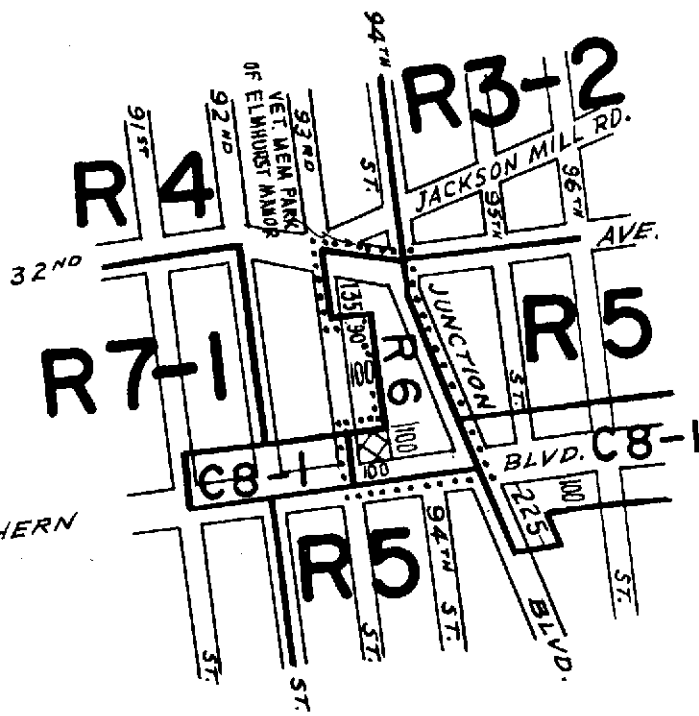



APPROVED BY BOARD OF ESTIMATE  
 CALENDAR # AMDT 1032  
 DATE 12/2/71

CITY PLANNING COMMISSION  
 CITY OF NEW YORK  
 DIAGRAM SHOWING PROPOSED  
 ZONING CHANGE  
 ON SECTIONAL MAP  
 9d  
 BOROUGH OF  
 QUEENS

New York, October 13, 1971

*Louis Roberts PE*  
 Director, Division of Zoning  
*Sam Frullo PE*  
 Chief Engineer



- NOTE:**
-  indicates Zoning District boundary.
  -  The area enclosed by the fine dotted line is proposed to be changed from C8-1 and R4 Districts to an R6 District, eliminating a C2-2 District from an existing R4 District and establishing a C1-2 District within a proposed R6 District.
  -  indicates a C1-2 District.

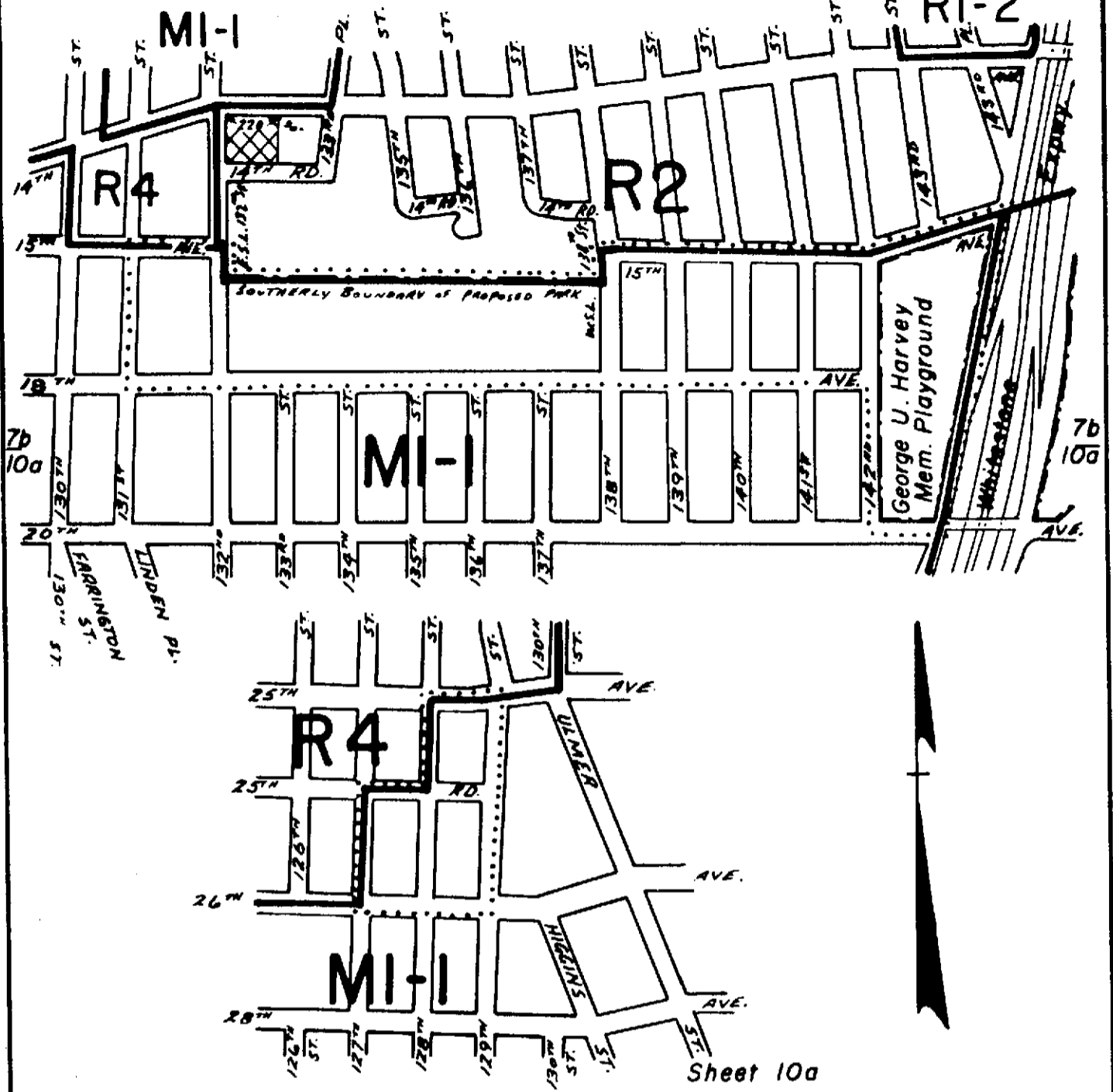

CITY PLANNING COMMISSION  
 CITY OF NEW YORK  
**DIAGRAM SHOWING PROPOSED  
 ZONING CHANGE  
 ON SECTIONAL MAPS  
 7b & 10a**  
 BOROUGH OF  
 QUEENS

New York, February 15, 1972

*Louis Robert, P.E.*  
 Director, Division of Zoning  
*Joni Amolter*  
 Chief Engineer



- NOTE:**
- indicates Zoning District boundary.
  - The areas enclosed by the fine dotted line are proposed to be changed from an R2, an R3-2 and an R4 District to an MI-1 District.
  - indicates a CI-2 District.

N.A.P. APPROVED BY BOARD OF ESTIMATE

CALENDAR # 1059 AMDT #

DATE 5/25/72

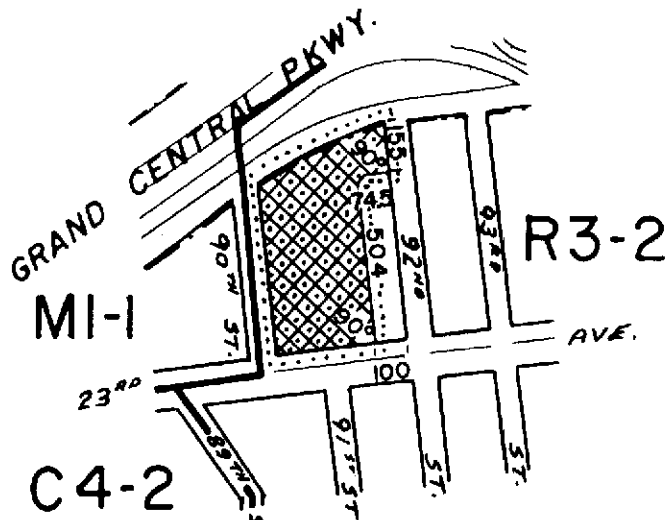

CITY PLANNING COMMISSION  
 CITY OF NEW YORK  
**DIAGRAM SHOWING PROPOSED  
 ZONING CHANGE  
 ON SECTIONAL MAP**

9c

BOROUGH OF  
QUEENS

New York, May 17, 1972

*Julius Specter PE.*  
 Acting Director, Division of Zoning  
*Jim Smith PE*  
 Chief Engineer



**NOTE:**

- indicates Zoning District boundary.
- The area enclosed by the fine dotted line is proposed to be changed by establishing a C2-2 District within an existing R3-2 District.
- indicates a C2-2 District.

N.A.P.

**APPROVED BY BOARD OF ESTIMATE**

**CALENDAR #** AMDT # 1073

**DATE** 7/20/72

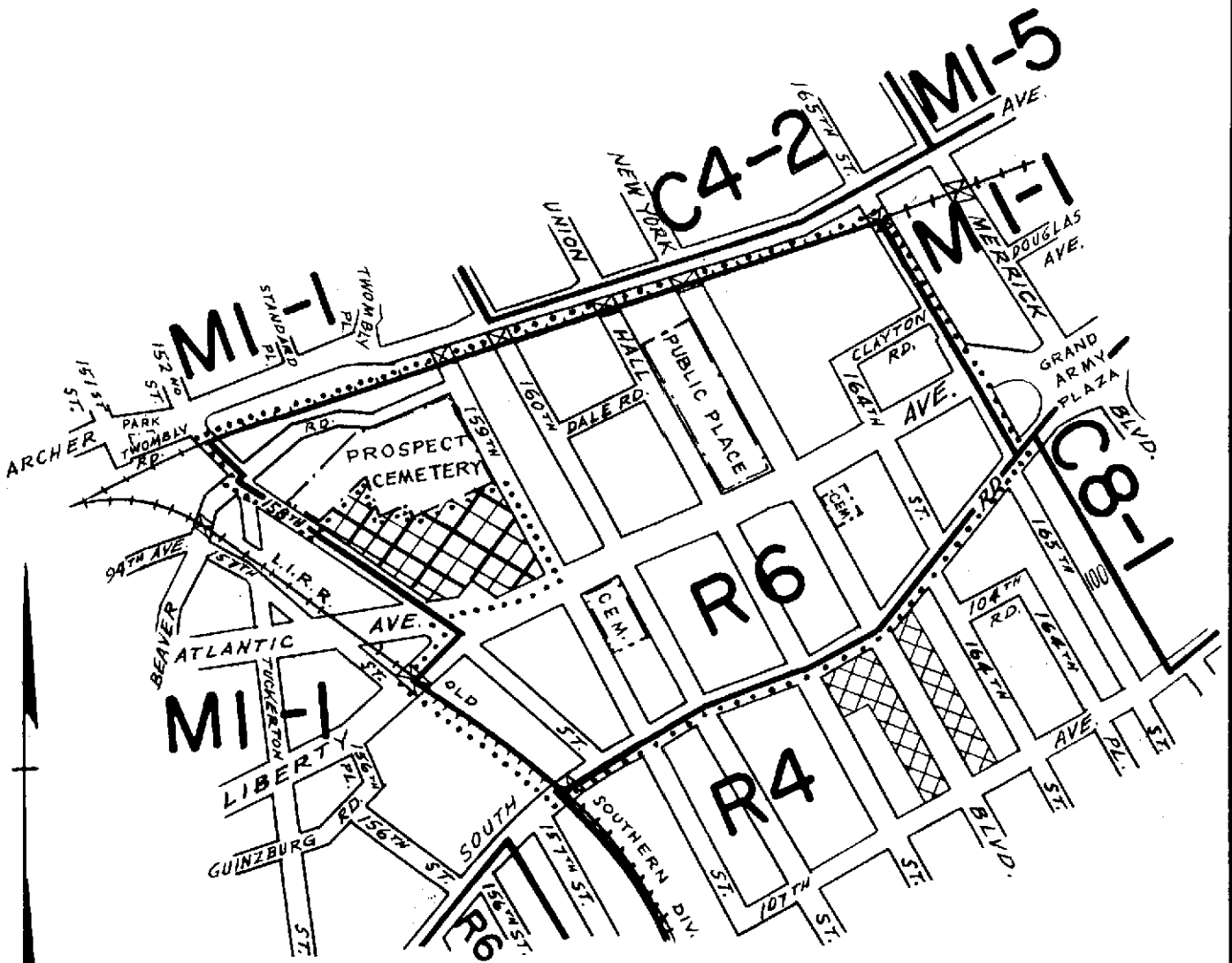

CITY PLANNING COMMISSION  
 CITY OF NEW YORK  
**DIAGRAM SHOWING PROPOSED  
 ZONING CHANGE  
 ON SECTIONAL MAP**

**14d**  
 BOROUGH OF  
 QUEENS

New York, **May 17, 1972**

*Julius Spector P.E.*  
 Acting Director, Division of Zoning  
*Jeri Franklin P.E.*  
 Chief Engineer

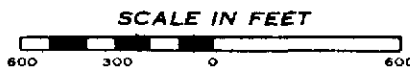

**NOTE:**

- indicates Zoning District boundary.
- The area enclosed by the fine dotted line is proposed to be changed from an MI-1 District to a R6 District.
- indicates a CI-2 District.
- indicates a CI-4 District.

**APPROVED BY BOARD OF ESTIMATE**

CALENDAR # AMDT # 1068

DATE 6/22/72

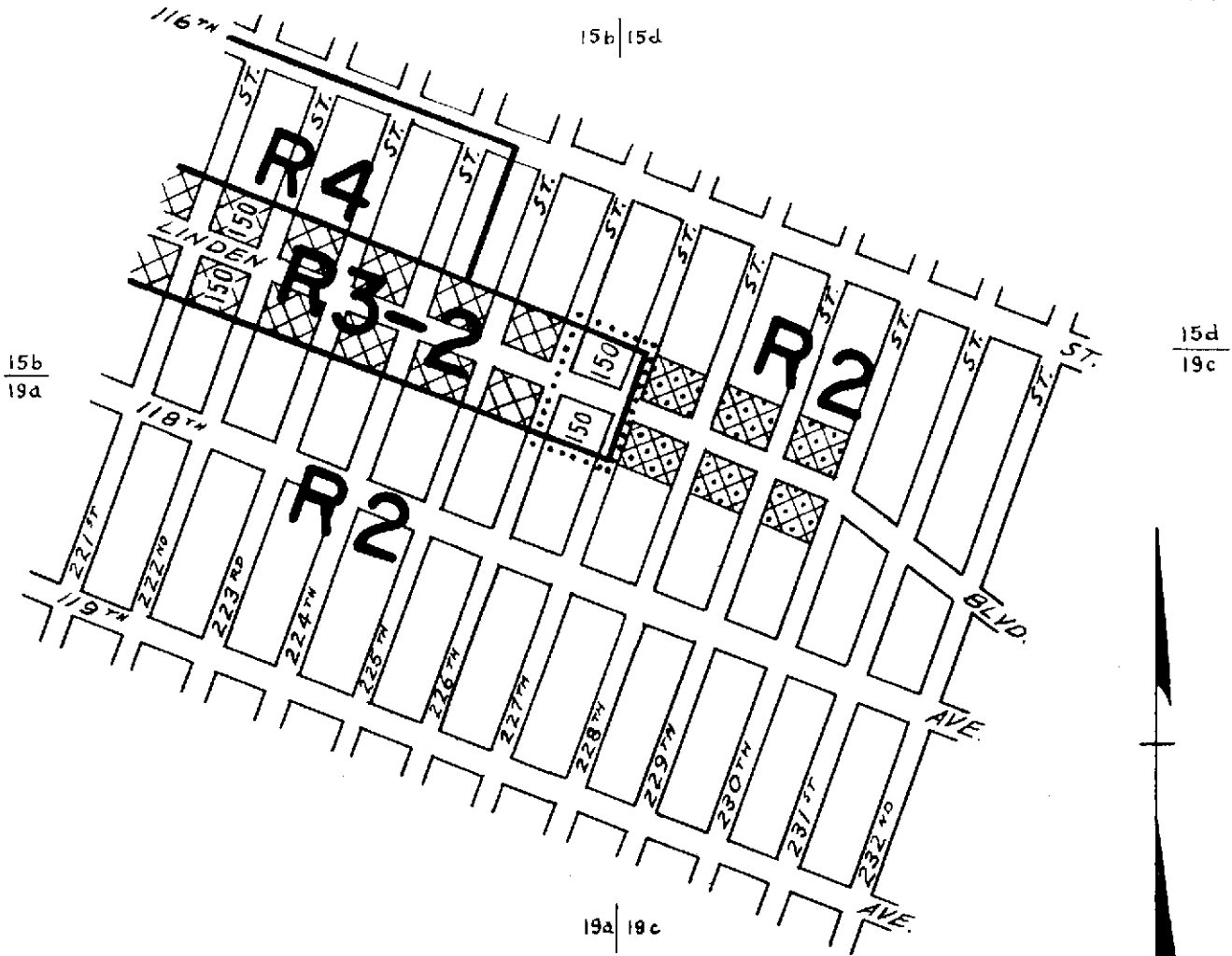

CITY PLANNING COMMISSION  
 CITY OF NEW YORK  
**DIAGRAM SHOWING PROPOSED  
 ZONING CHANGE  
 ON SECTIONAL MAP**  
**15b, 15d, 19a & 19c**  
 BOROUGH OF  
 QUEENS

New York, August 2, 1972

*Louis Roberts, P.E.*  
Director, Division of Zoning

*Max Kogerski, P.E.*  
Chf. Chief Engineer



**NOTE:**

- indicates Zoning District boundary.
- The area enclosed by the fine dotted line is proposed to be changed from an R2 District to an R3-2 District.
- indicates a C1-2 District.
- indicates a C2-2 District.

C.H.

**APPROVED BY BOARD OF ESTIMATE**

CALENDAR # AMPT # 1089

DATE 11/10/72

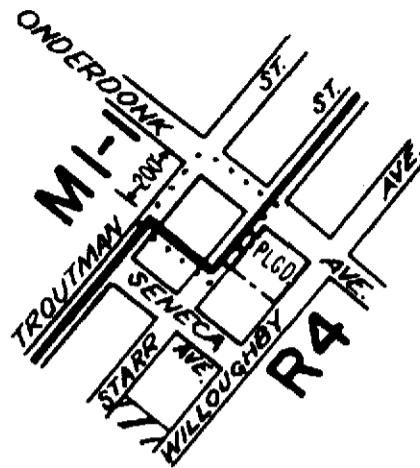



CITY PLANNING COMMISSION  
CITY OF NEW YORK  
**DIAGRAM SHOWING PROPOSED  
ZONING CHANGE  
ON SECTIONAL MAP  
13b  
BOROUGH OF  
QUEENS**

New York, November 29, 1972

*Louis Roberti, P.E.*  
Director, Division of Zoning  
*John J. Smith, P.E.*  
Chief Engineer



- NOTE:**
-  indicates Zoning District boundary.
  -  The area enclosed by the fine dotted line is proposed to be changed from an R4 District to an MI-1 District.
  -  indicates a CI-3 District.

**APPROVED BY BOARD OF ESTIMATE**

~~CALENDAR #~~ AMDT # 1100

DATE 1/11/73

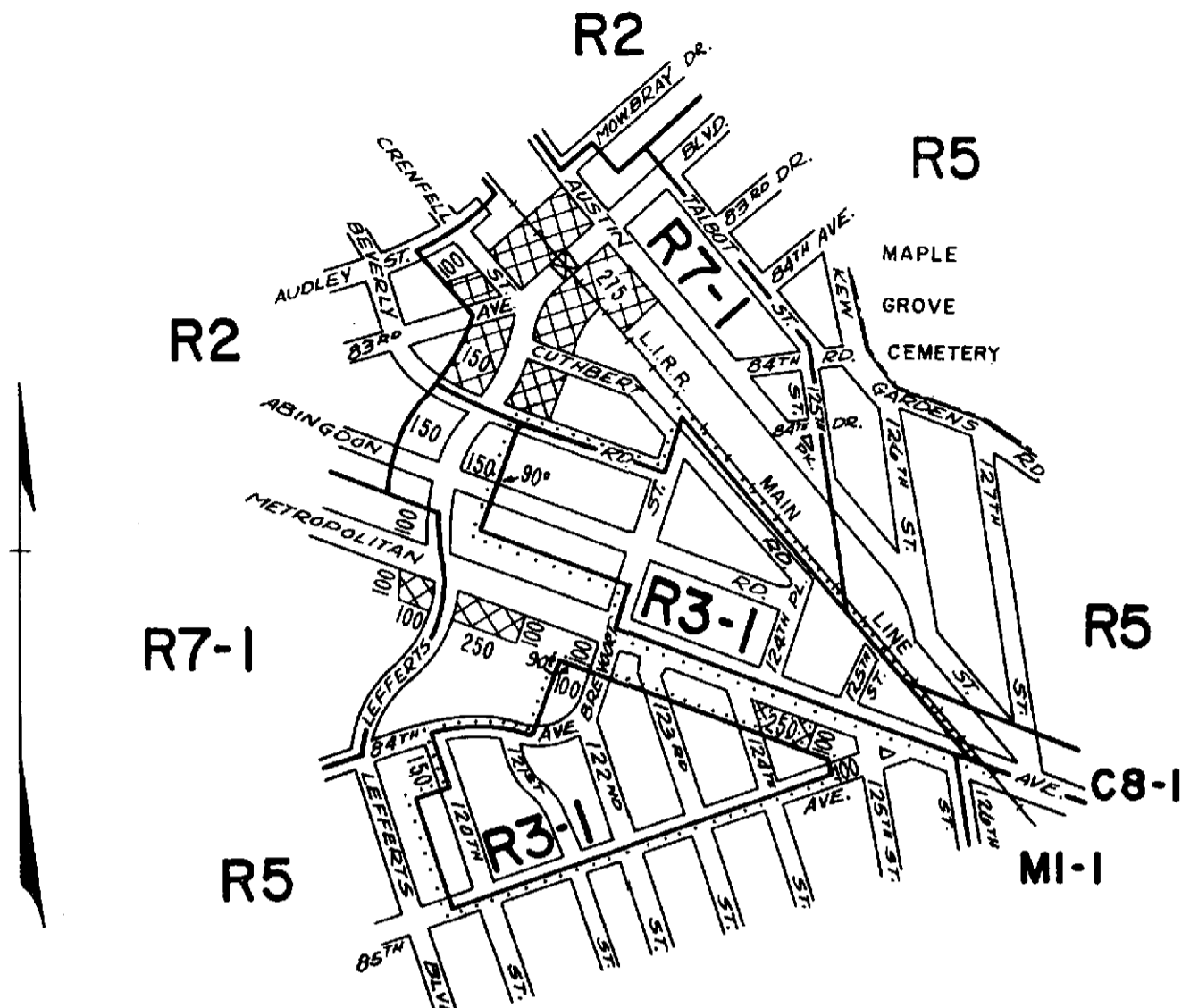

APPROVED BY BOARD OF ESTIMATE R5

CALENDAR # AMDT # 1121

DATE 5/24/73 CITY PLANNING COMMISSION

CITY OF NEW YORK  
DIAGRAM SHOWING PROPOSED  
ZONING CHANGE  
ON SECTIONAL MAP

14b



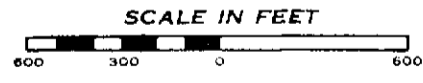

BOROUGH OF QUEENS

Modified by B. of E.  
May 24, 1973 Cal. No. 222  
New York, March 14, 1973

*Louis Roberti, P.E.*  
Director, Division of Zoning  
*Jiri Trnka, P.E.*  
Chief Engineer



NOTE:

-  indicates Zoning District boundary.
-  The areas enclosed by the fine dotted lines are proposed to be changed from R7-1, R5 and C8-1 Districts to R3-1 Districts.
-  indicates a C1-2 District.
-  indicates a C2-2 District.



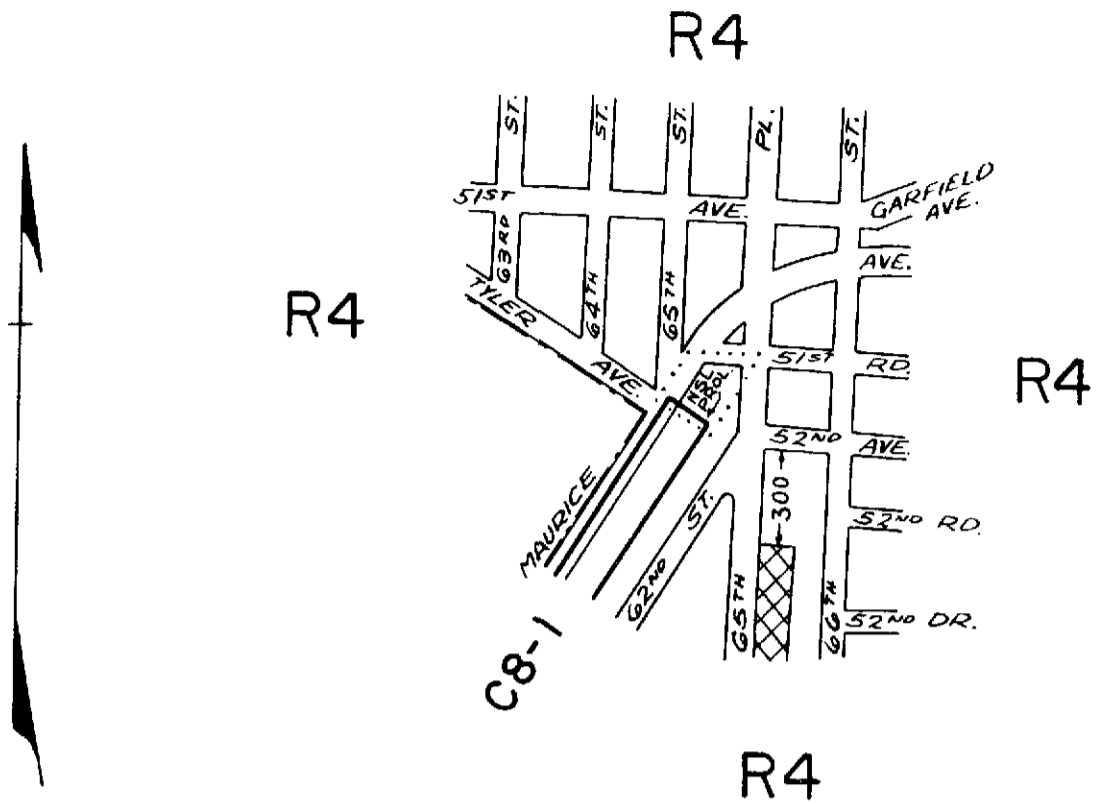

CITY PLANNING COMMISSION  
 CITY OF NEW YORK  
 DIAGRAM SHOWING PROPOSED  
 ZONING CHANGE  
 ON SECTIONAL MAP

13c  
 BOROUGH OF  
 QUEENS

New York, April 4, 1973

*Louis Roberts, P.E.*  
 Director, Division of Zoning  
*Jim Smith, PE*  
 Chief Engineer

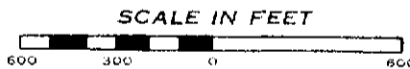

NOTE:

- indicates Zoning District boundary.
- The area enclosed by the fine dotted line is proposed to be changed from a C8-1 District to an R4 District.
- indicates a C1-2 District.

A. J. P.

**APPROVED BY BOARD OF ESTIMATE**

~~CALENDAR #~~ AMPT # 1123

DATE 6/21/73

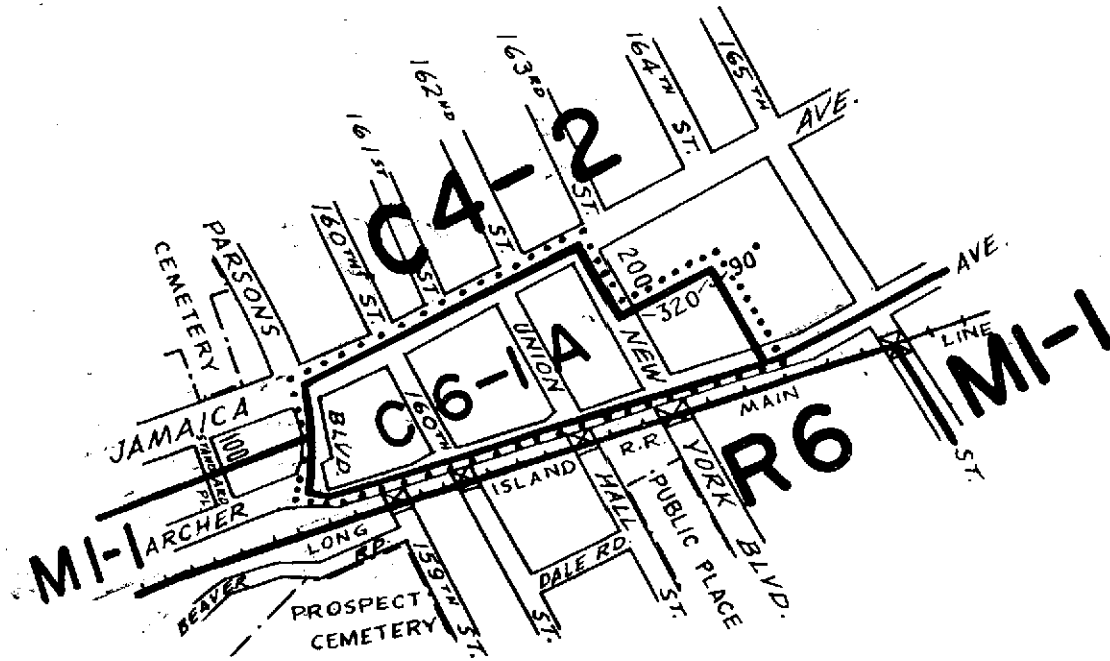

CITY PLANNING COMMISSION  
 CITY OF NEW YORK  
**DIAGRAM SHOWING PROPOSED  
 ZONING CHANGE  
 ON SECTIONAL MAP  
 14 d**  
 BOROUGH OF  
 QUEENS

New York, April 4, 1973

*Louis Roberti, P.E.*  
 Director, Division of Zoning

*Jiri Frouth PE*  
 Chief Engineer



- NOTE:**
- \_\_\_\_\_ indicates Zoning District boundary.
  - ..... The area enclosed by the fine dotted line is proposed to be changed from C4-2 and MI-1 Districts to a C6-1A District.

C.H.

*✓ HC*  
**APPROVED BY BOARD OF ESTIMATE**

**CALENDAR #** ANDT # 1124

**DATE** 6/21/73

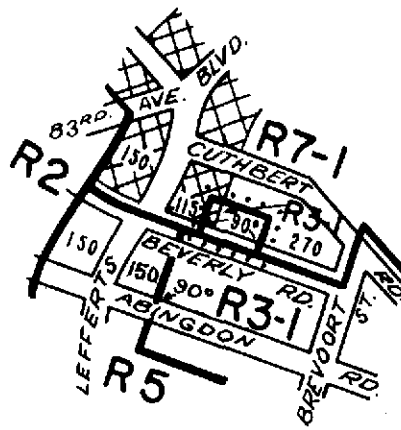



CITY PLANNING COMMISSION  
CITY OF NEW YORK  
**DIAGRAM SHOWING PROPOSED  
ZONING CHANGE  
ON SECTIONAL MAP  
14b**

BOROUGH OF  
QUEENS

New York, **May 30, 1973**

*Richard Riegelhaupt, P.E.*  
Acting Director, Division of Zoning  
*Jimmie Fruchman, P.E.*  
Chief, Office of Technical Controls



- NOTE:**
-  indicates Zoning District boundary.
  -  The area enclosed by the fine dotted line is proposed to be changed from an R7-1 District to an R3-1 District.
  -  indicates a CI-2 District.

**APPROVED BY BOARD OF ESTIMATE**

**CALENDAR #** ANDT # 1126

**DATE** 6/21/73

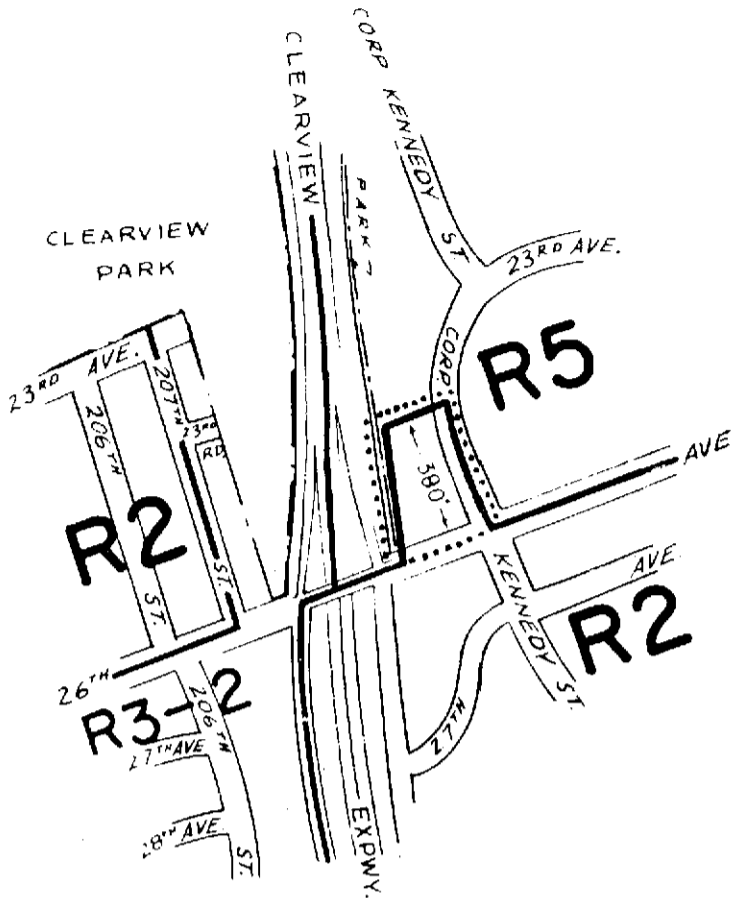

CITY PLANNING COMMISSION  
 CITY OF NEW YORK  
 DIAGRAM SHOWING PROPOSED  
 ZONING CHANGE  
 ON SECTIONAL MAP

**10c**  
 BOROUGH OF  
 QUEENS

New York May 14, 1973

*Richard Regalbuto PE*  
 Acting Director, Division of Zoning  
*Jim Amolter PE*  
 Chief Engineer

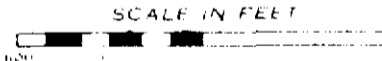

**NOTE:**  
 ————— indicates Zoning District boundary.  
 ..... The area enclosed by the fine dotted line is proposed to be changed from  
 an R5 District to an R2 District.

**APPROVED BY BOARD OF ESTIMATE**

**CALENDAR #** AMDT #1128

**DATE** 7/19/73

C.P. 22446

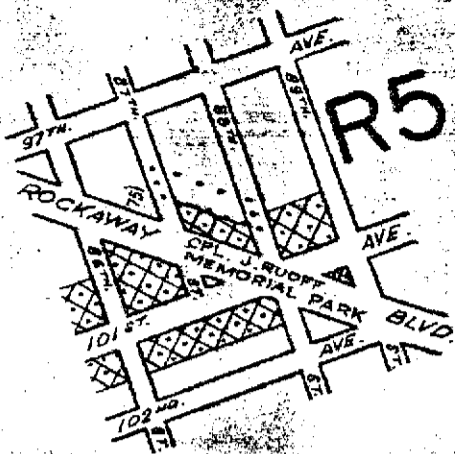

9/21/73  
12/20/73

604

CITY PLANNING COMMISSION  
 CITY OF NEW YORK  
**DIAGRAM SHOWING PROPOSED  
 ZONING CHANGE  
 ON SECTIONAL MAP  
 18a**

BOROUGH OF  
QUEENS

New York, November 14, 1973

*Louis Roberts, P.E.*  
 Director, Division of Zoning  
*Jim Smith, P.E.*  
 Chief Engineer



**NOTE:**

- indicates Zoning District boundary.
- The area enclosed by the fine dotted line is proposed to be changed by eliminating a C2-2 District within an existing R5 District.
- indicates a C2-2 District.

**APPROVED BY BOARD OF ESTIMATE**

CALENDAR # AMDT # 1146

DATE 12/20/73

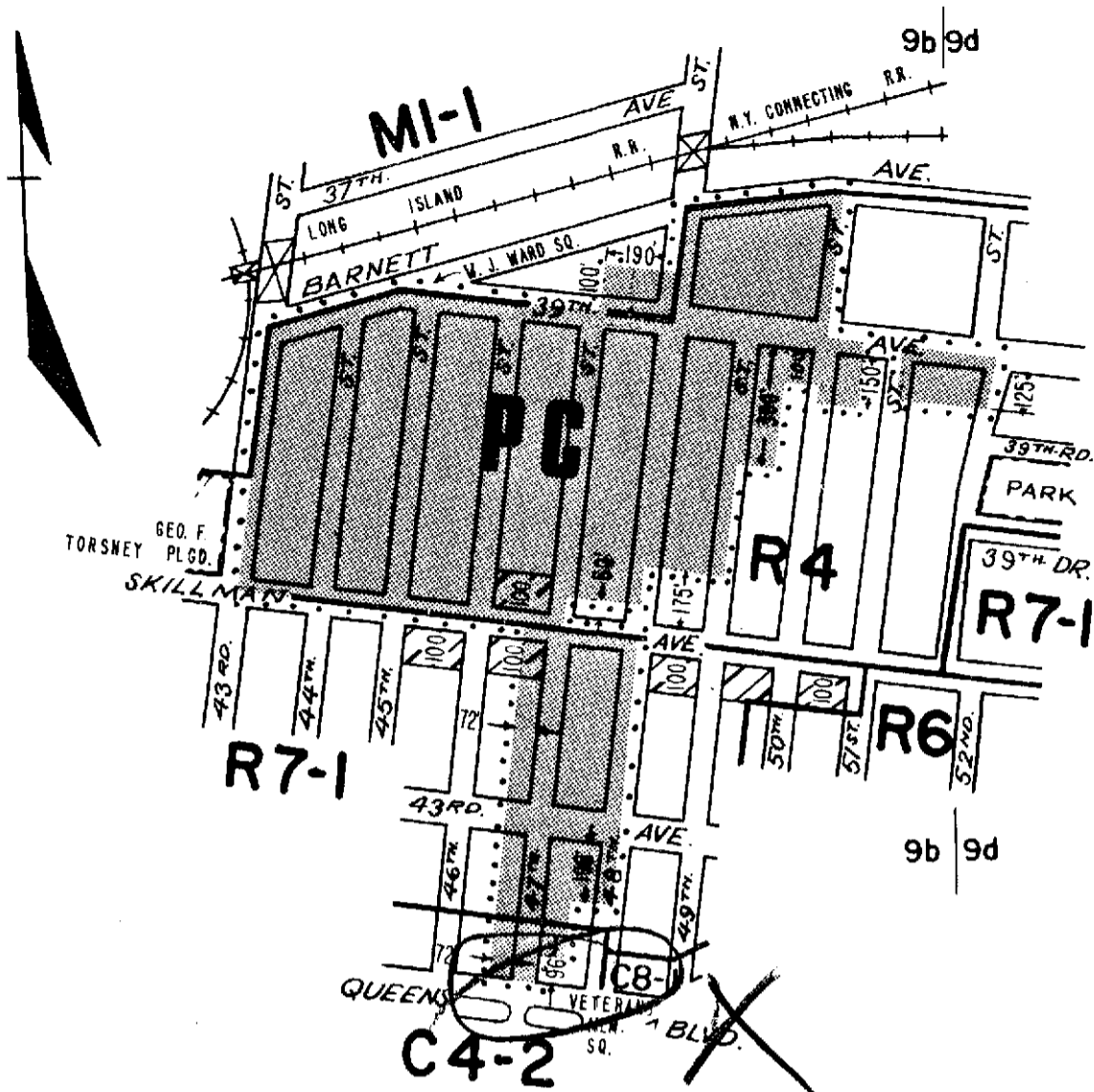





CITY PLANNING COMMISSION  
 CITY OF NEW YORK  
 DIAGRAM SHOWING PROPOSED  
 ZONING CHANGE  
 ON SECTIONAL MAPS

9b & 9d  
 BOROUGH OF  
 QUEENS

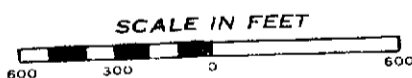
New York, November 7, 1973

*Louisa Roberts, P.E.*  
 Director, Division of Zoning  
*Jiri Trnka, P.E.*  
 Chief Engineer

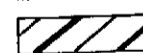

- NOTE:**
-  indicates Zoning District boundary.
  -  The area enclosed by the fine dotted line is proposed to be changed by establishing a PC District
  -  indicates a PC District.
  -  indicates a C1-3 District.

APPROVED BY BOARD OF ESTIMATE

CALENDAR # AMPT # 1164

DATE 7/18/74

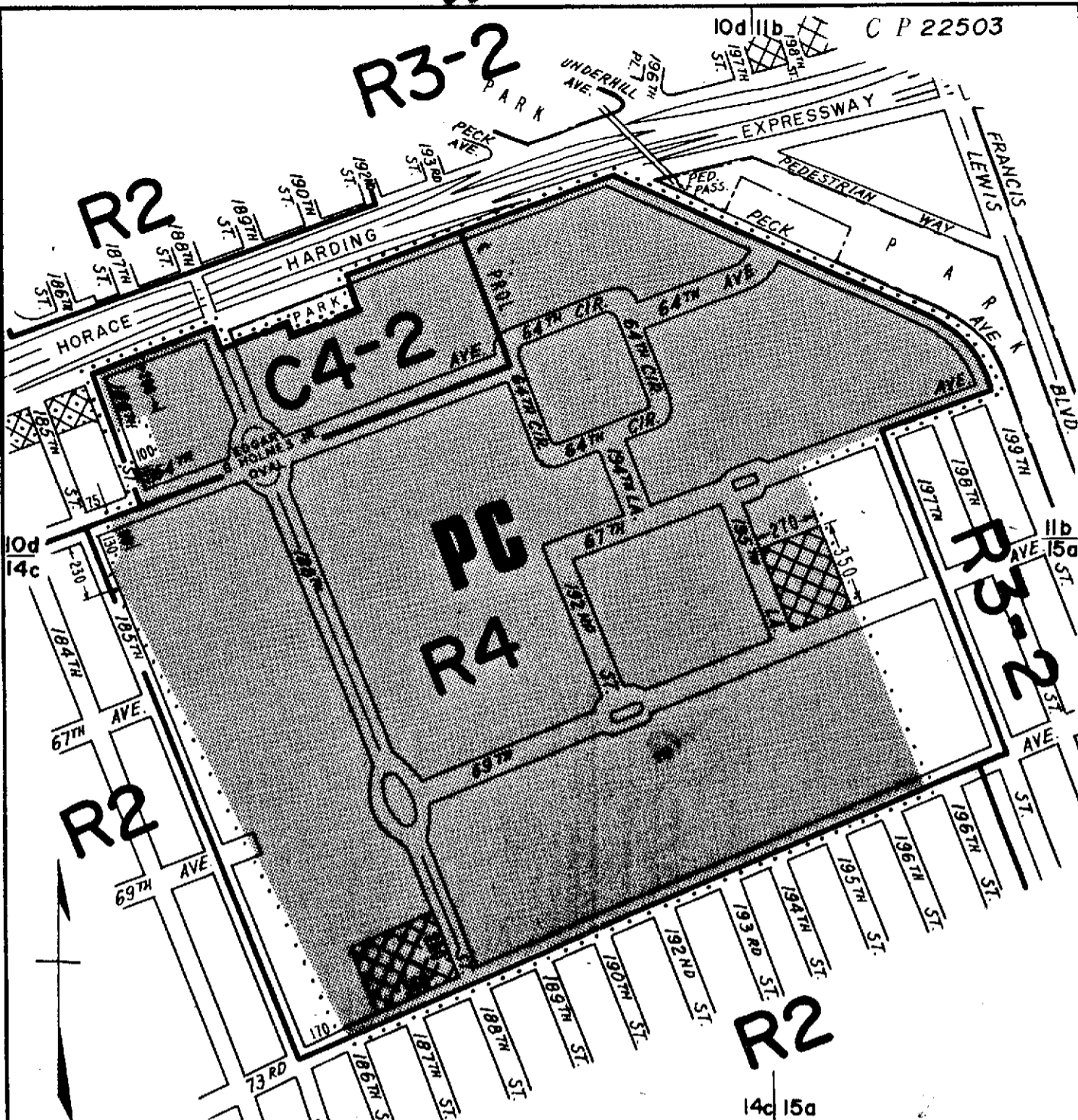

CITY PLANNING COMMISSION  
 CITY OF NEW YORK  
**DIAGRAM SHOWING PROPOSED  
 ZONING CHANGE  
 ON SECTIONAL MAPS  
 10d, 11b, 14c, & 15a**  
 BOROUGH OF  
 QUEENS

New York, November 7, 1973

*Louis Roberti, P.E.*  
 Director, Division of Zoning  
*J. J. Smith, P.E.*  
 Chief Engineer



- NOTE:**
- indicates Zoning District boundary.
  - The area enclosed by the fine dotted line is proposed to be changed by establishing a PC District.
  - indicates a PC District.
  - indicates a C1-2 District.
  - indicates a C2-2 District.

**APPROVED BY BOARD OF ESTIMATE**

CALENDAR # AMDT # 1165

DATE 7/18/74

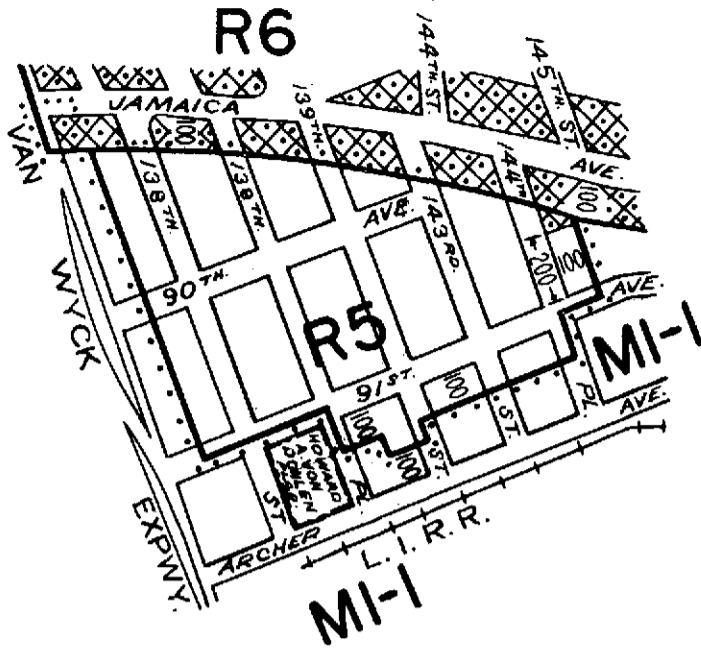

CITY PLANNING COMMISSION  
 CITY OF NEW YORK  
**DIAGRAM SHOWING PROPOSED  
 ZONING CHANGE  
 ON SECTIONAL MAP**

14 d



BOROUGH OF  
 QUEENS

Mod. December 12, 1973  
 New York, November 14, 1973

*Louis Roberti, PE.*  
 Director, Division of Zoning  
*J. J. Smith, PE.*  
 Chief Engineer



**NOTE:**

-  indicates Zoning District boundary.
-  The area enclosed by the fine dotted line is proposed to be changed from an MI-1 District to R5 and R6 Districts and establishing C2-2 Districts within the proposed R5 and R6 Districts.
-  Indicates a C2-2 District.

**APPROVED BY BOARD OF ESTIMATE**

~~CALENDAR #~~ AMDT # 1151

DATE 1/10/74



APPROVED BY BOARD OF ESTIMATE

CALENDAR # Ord # 113-3

DATE 4/1/25/74

(603)

C. P. 22622

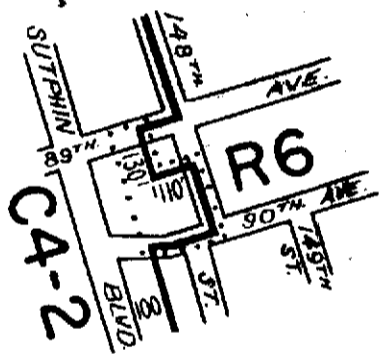

CITY PLANNING COMMISSION  
CITY OF NEW YORK  
DIAGRAM SHOWING PROPOSED  
ZONING CHANGE  
ON SECTIONAL MAP  
14d

BOROUGH OF  
QUEENS

New York, March 13, 1974

*Louis Roberts, P.E.*  
Director, Division of Zoning  
*Kevin Frueh, P.E.*  
Chief Engineer



NOTE:

- indicates Zoning District boundary.
- ..... The area enclosed by the fine dotted line is proposed to be changed from an R6 District to a C4-2 District.

APPROVED BY BOARD OF ESTIMATE

CALENDAR # Assess # 1154

DATE 4/25/74

60.5

C.P. 22624

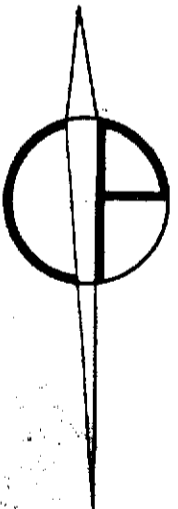
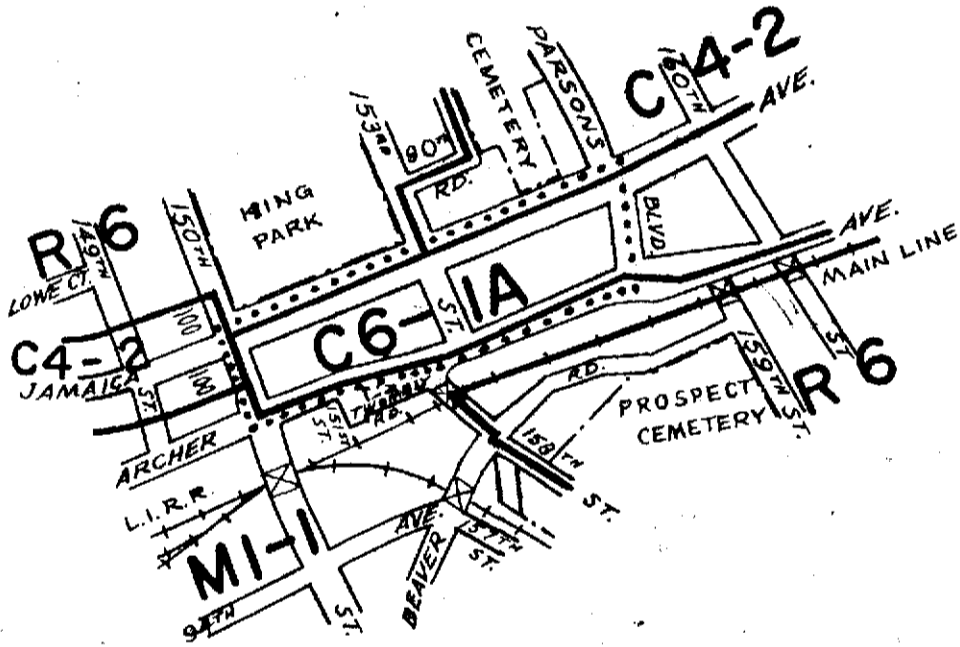

CITY PLANNING COMMISSION  
 CITY OF NEW YORK  
 DIAGRAM SHOWING PROPOSED  
 ZONING CHANGE  
 ON SECTIONAL MAP

14d

BOROUGH OF  
QUEENS

New York, March 13, 1974

*Louis Roberti, P.E.*  
 Director, Division of Zoning  
*James Fruchter, P.E.*  
 Chief Engineer

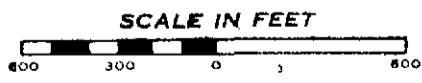

**NOTE:**

- indicates Zoning District boundary.
- The area enclosed by the fine dotted line is proposed to be changed from C4-2 and MI-1 Districts to a C6-1A District.

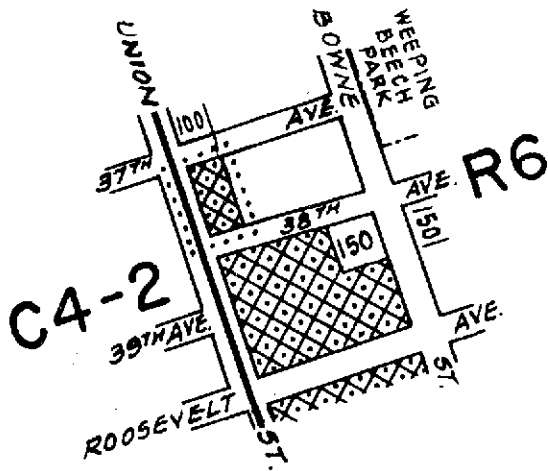

CITY PLANNING COMMISSION  
 CITY OF NEW YORK  
**DIAGRAM SHOWING PROPOSED  
 ZONING CHANGE  
 ON SECTIONAL MAP  
 10a**  
 BOROUGH OF  
 QUEENS

New York, May 1, 1974

*Richard Riegelhaupt, P.E.*  
 Acting Director, Division of Zoning  
*John Frucht, P.E.*  
 Chief Engineer



- NOTE:**
- indicates Zoning District boundary.
  - The area enclosed by the fine dotted line is proposed to be changed by establishing a C2-2 District within an R6 District.
  - indicates a C2-2 District.

**APPROVED BY BOARD OF ESTIMATE**

~~CALENDAR #~~ AMDT # 1160

DATE 6/20/74

C.P. 22805

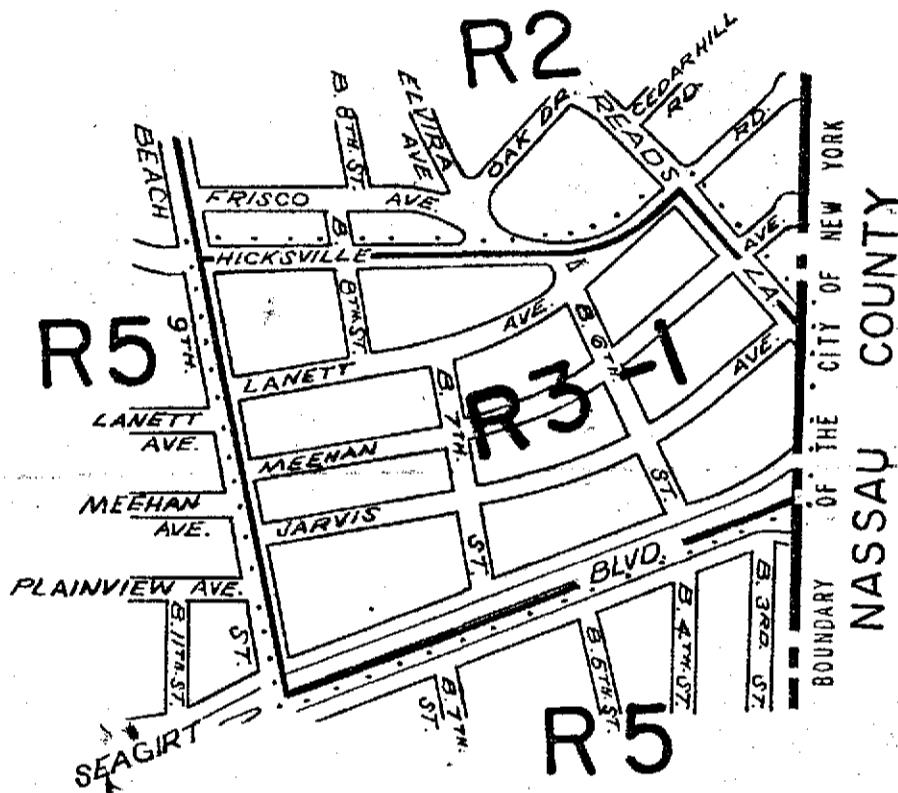
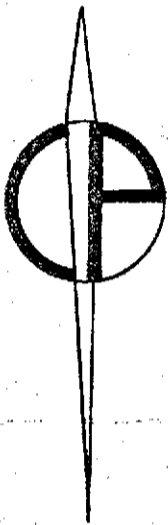

CITY PLANNING COMMISSION  
 CITY OF NEW YORK  
**DIAGRAM SHOWING PROPOSED  
 ZONING CHANGE  
 ON SECTIONAL MAP**

31 a

BOROUGH OF  
QUEENS

New York, September 9, 1974

*J. Friedman* P.E.

Director, Division of Zoning

*J. Frucht* P.E.

Chief Engineer

SCALE IN FEET

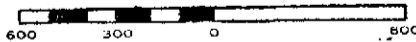

**NOTE:**

- indicates Zoning District boundary.
- .....** The area enclosed by the fine dotted line is proposed to be changed from an R3-2 District to an R3-1 District.

**APPROVED BY BOARD OF ESTIMATE**

CALENDAR # AMDT #1176

DATE 10/24/74 - 10/10/74

2C

RES. DECLR. D-4

60.5

C. P. 22836

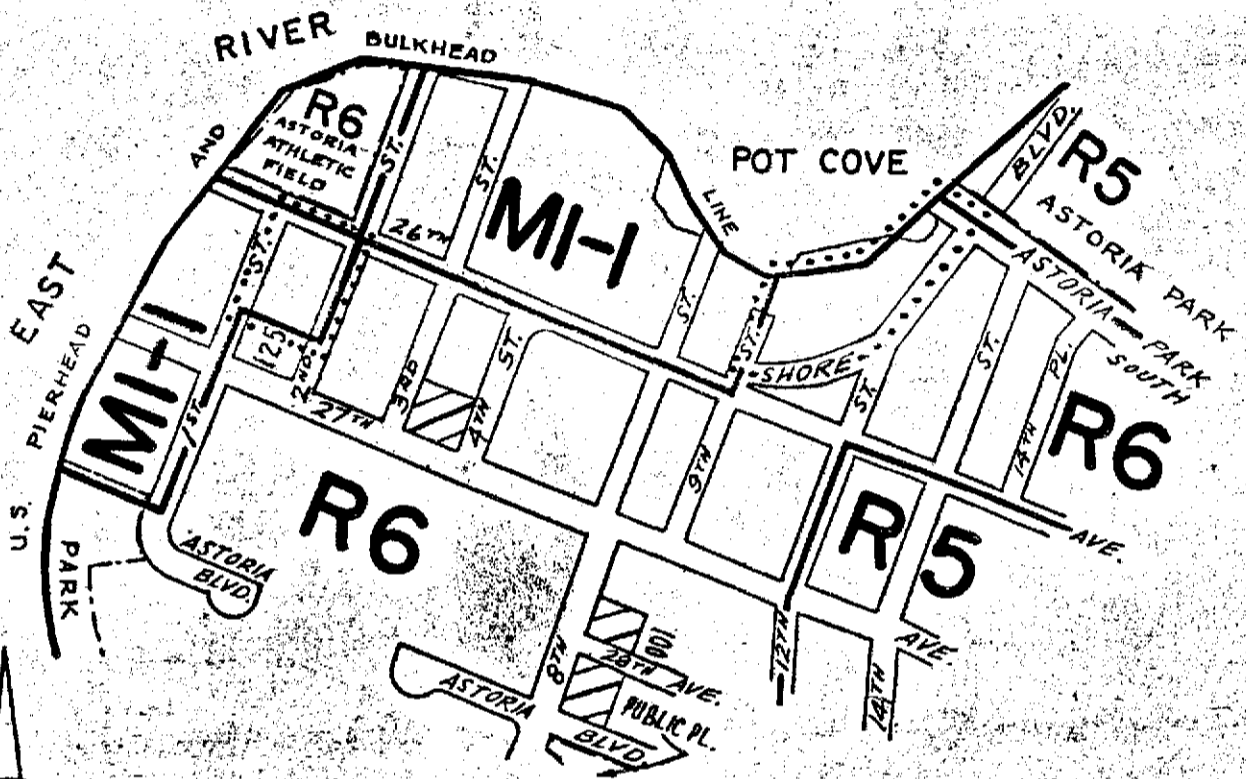

CITY PLANNING COMMISSION  
 CITY OF NEW YORK  
 DIAGRAM SHOWING PROPOSED  
 ZONING CHANGE  
 ON SECTIONAL MAP

9a

BOROUGH OF QUEENS

New York, October 30, 1974  
 Modified by Bd. of Est.  
 Cal. No. 49, March 6, 1975

*Richard DE*  
 Director, Division of Zoning  
*J. J. Smith PE*  
 Chief Engineer

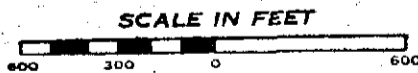

NOTE:

- indicates Zoning District boundary.
- ..... The area enclosed by the fine dotted line is proposed to be changed from an MI-1 District to an R6 District and from an R6 District to an MI-1 District.

 indicates a C1-3 District.

APPROVED BY BOARD OF ESTIMATE

CALENDAR # AMDT # 1189

DATE 3/6/75

C.H.

4 1/2

60.5

C.P. 22775

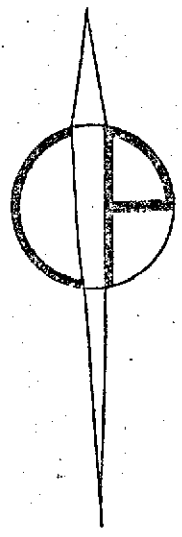
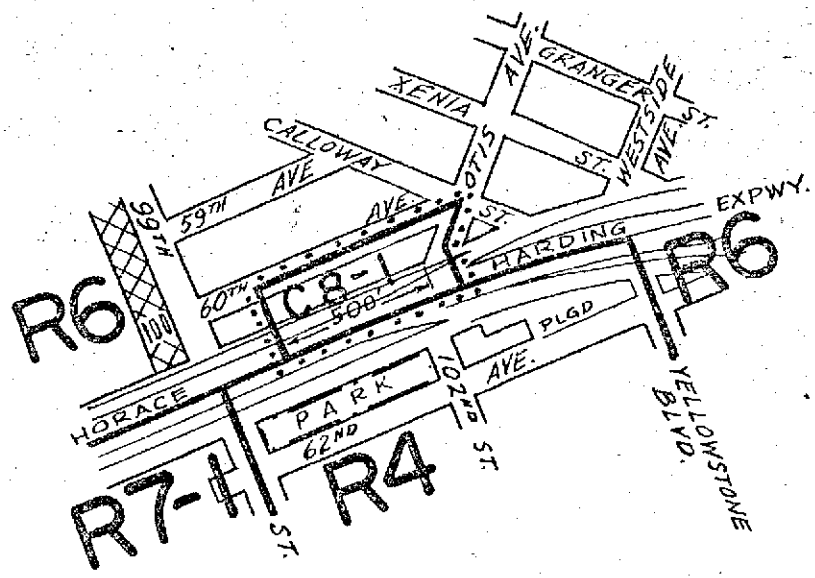

CITY PLANNING COMMISSION  
 CITY OF NEW YORK  
 DIAGRAM SHOWING PROPOSED  
 ZONING CHANGE  
 ON SECTIONAL MAP

14a  
 BOROUGH OF  
 QUEENS

*G. Kusner* P.E.  
 Director, Division of Zoning

*J. Spector* P.E.  
 Acting Chief Engineer

New York, July 22, 1974  
 Modified by Bd. of Estimate  
 Cal. No. 35, dated April 24, 1975

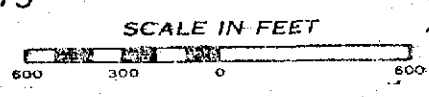

- NOTE:**
- indicates Zoning District boundary.
  - The area enclosed by the fine dotted line is proposed to be changed from an R6 District to a C8-1 District.
  - indicates a C1-2 District.

**APPROVED BY BOARD OF ESTIMATE**

C.H.

~~CALENDAR #~~ AMDT # 1195

DATE 4/24/75

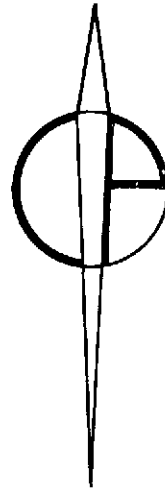
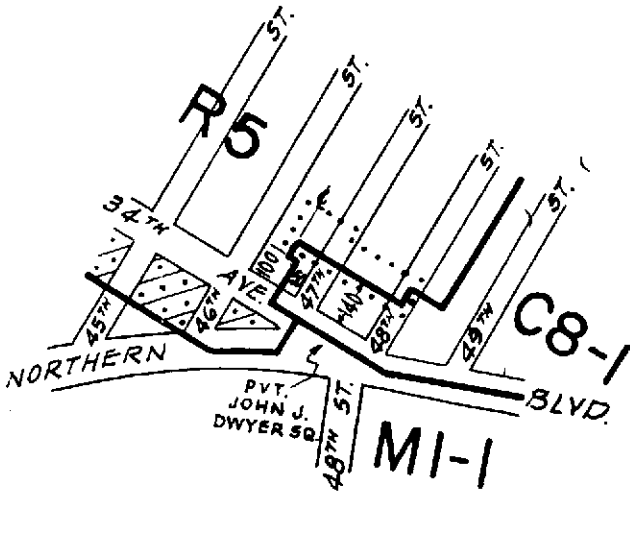

CITY PLANNING COMMISSION  
 CITY OF NEW YORK  
**DIAGRAM SHOWING PROPOSED  
 ZONING CHANGE  
 ON SECTIONAL MAP  
 9b**

BOROUGH OF  
 QUEENS

New York, February 26, 1975

*A. Friedman PE*  
 Director, Division of Zoning

*Julius Specter PE*  
 Acting Chief Engineer



**NOTE:**

- indicates Zoning District boundary.
- The area enclosed by the fine dotted line is proposed to be changed from a C8-1 District to an R5 District.
- indicates a C2-1 District.

~~APPROVED BY BOARD OF ESTIMATE~~

~~CALENDAR # AMDT # 1195~~

~~DATE 5/8/75~~

APPROVED BY BOARD OF ESTIMATE

CALENDAR # AMDT # 1198

DATE 5/8/75

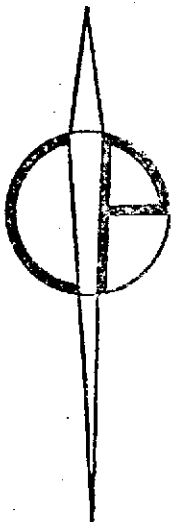
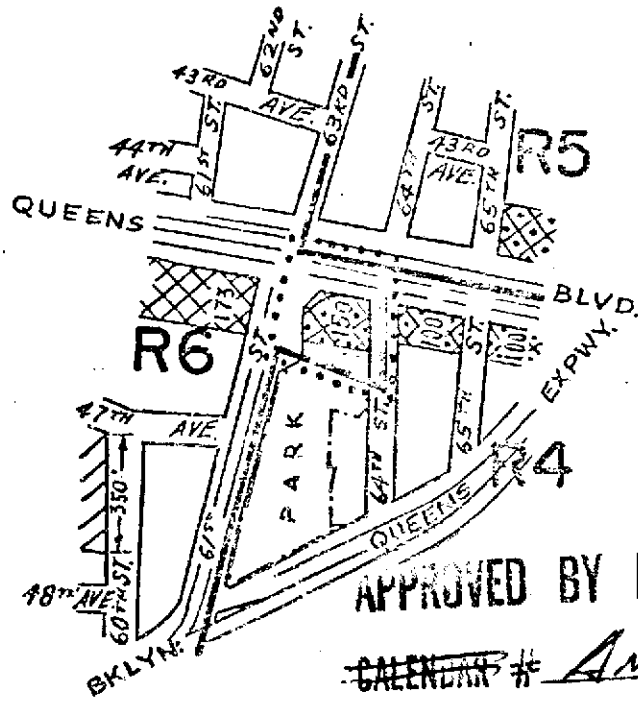

APPROVED BY BOARD OF ESTIMATE

~~CALENDAR~~ # AMPT # 1213

DATE 3/4/76

CITY PLANNING COMMISSION  
 CITY OF NEW YORK  
 DIAGRAM SHOWING PROPOSED  
 ZONING CHANGE  
 ON SECTIONAL MAP

9d

BOROUGH OF QUEENS

New York, December 10, 1975

*J. Gradman P.E.*  
 Director, Division of Zoning  
*J. Smith P.E.*  
 Chief Engineer

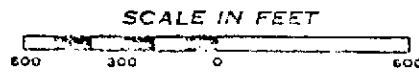

NOTE:

———— indicates Zoning District boundary.

..... The area enclosed by the fine dotted line is proposed to be changed from an R4 District to an R6 District and eliminating a C2-2 District from within a proposed R5 District.

indicates a C1-2 District.

indicates a C2-2 District.



C.P. 23211

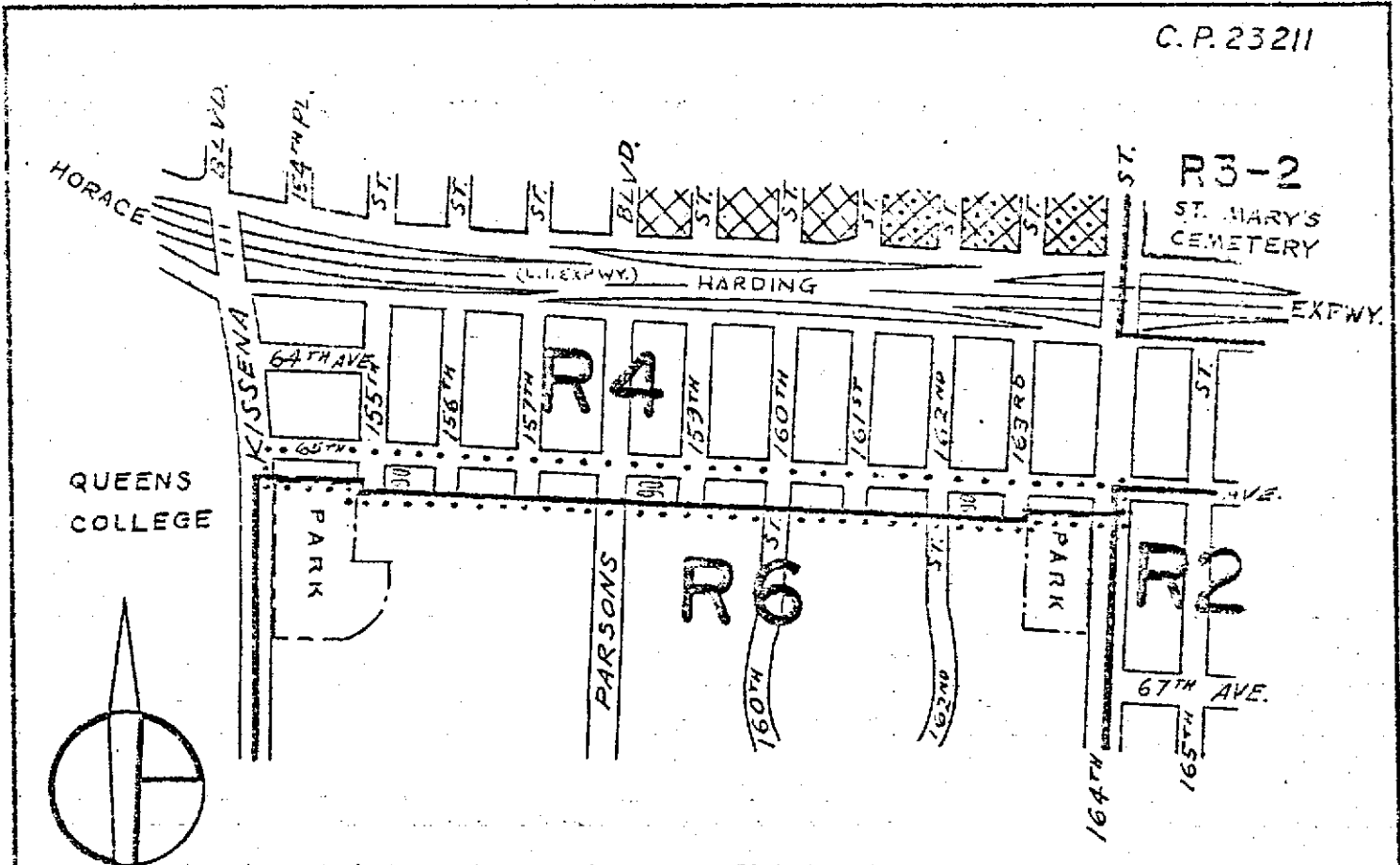

CITY PLANNING COMMISSION  
 CITY OF NEW YORK  
 DIAGRAM SHOWING PROPOSED  
 ZONING CHANGE  
 ON SECTIONAL MAP



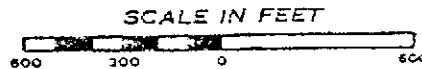

14c  
 BOROUGH OF  
 QUEENS

New York, March 31, 1976

*Abraham P.E.*  
 Director, Division of Zoning  
*J. Fruchter P.E.*  
 Chief Engineer



**NOTE:**

-  indicates Zoning District boundary.
-  The area enclosed by the fine dotted line is proposed to be changed from an R6 District to an R4 District.
-  indicates a C1-2 District.
-  indicates a C2-2 District.

C.H.

APPROVED BY BOARD OF ESTIMATE

CALENDAR # AMDT # 1216

DATE 5/20/76

of the New York Resolution of the establishment of new Section in special com- located partially within the ng Board No. 6,

to be omitted; Section 12-10.

declina- of this

(ex- ert- ional

vide uest Horizontal dis- tance

6 to 1 C4-2A

as a ratio (distance)

street Horizontal distance

C4-2A

, or C6, Districts

C4-2A

C5, or C6 Districts

C4-2A

C4-2A

g lots in single ownership which are would be contiguous but for their a street and located partially in a partially in a C4-2A District, par- R8 District and partially in a C2-2 ed within an R8 District, the City

in the street view of the building is provided in the open space in the development and such open space is maintained with planting and seating facilities by the owner of the development or his designee.

(h) the distribution of the total residential floor area, dwelling units, rooms or required open space on a zoning lot within the develop- ment without regard for district boundary lines. The Commission may impose additional condi- tions and safeguards to improve the quality of the development and minimize adverse effects on the character of the surrounding area, includ- ing restrictions on permitted commercial uses, signs and location of curb cuts to ease vehicular and pedestrian circulation in the area. Section 24-99 (Lapse of Permit) shall not apply to a special use permit granted for a develop- ment or enlargement undertaken pursuant to a special permit under this Section.

For the purposes of this Section:

(1) the tower regulations of Section 23-65 may apply to all residential and commercial developments or enlargements or portions thereof, which at any given level in aggregate occupies not more than 40 per cent of the lot area of a zoning lot;

(2) an adjoining public park shall not be considered a street; and

(3) the zoning lots within the development or enlargement may be subdivided before, during or after development, and conveyed or disposed of to different owners. Such sub-

# OFF-TRACK BETTING CORPORATION

## PROPOSALS

SEALED BIDS WILL BE RECEIVED BY the New York City Off-Track Betting Corpora- tion, 1501 Broadway, 12th floor, New York, N. Y. 10036, as follows:

The public opening and reading of bids in each case will be commenced at the time, date and place specified.

Until 2:30 p. m., on **TUESDAY, MARCH 9, 1976**

For alteration and construction work at construc- tion site located at 56 East 59th Street, Manhattan, N. Y.

A \$25.00 deposit (checks only) is required for each set of plans.

Separate specifications have been prepared and separate bids are requested for (a) Plumbing and Gas Fittings (b) Steam Heating, Hot Water Heat- ing, Ventilating, and Air Conditioning Apparatus (c) Electric Wiring and Standard Illuminating Fix- tures and (d) Dry Wall and other General Con- struction.

C.P. 23186

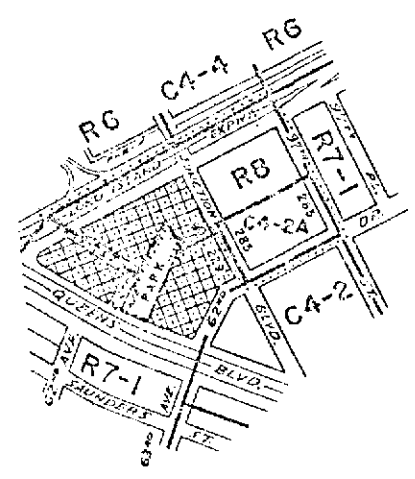
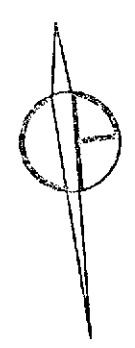

### CITY PLANNING COMMISSION CITY OF NEW YORK DIAGRAM SHOWING PROPOSED ZONING CHANGE ON SECTIONAL MAP

14a  
BOROUGH OF  
QUEENS

New York, February 25, 1976

Secretary

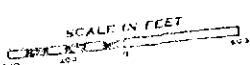

**NOTE:**

----- indicates Zoning District boundary.

..... The area enclosed by the fine dotted line is proposed to be changed from an R7-1 District to R8 and C4-2A Districts.

▨ indicates a C2-2 District.

*[Signature]*  
Director, Division of Zoning

*[Signature]*  
Chief, Office of Technical Controls

**APPROVED BY BOARD OF ESTIMATE**

**CALENDAR # AMDT # 1219**

**DATE 7/22/76**

City of New York, New York, N.Y. 10007. Specifications of the contract drawings.

NOTE: All work is to be com- 21, 1976 and August 25, 1976. Blue Print deposit--\$25.

Until 11 a. m., on **TUESDAY, MARCH 9**

For furnishing and deliv- Cards or equal, top left corner others in the following colors: and Blue, to the Comptroller's Office, 138th Street and Convent N. Y. 10031. Scheduled month- the period July 1, 1976 through

Until 11 a. m., on **THURSDAY, MARCH 11**

For furnishing and deliv- bids or equal to the City Com- ter, 138th Street and Convent N. Y. 10031:

IBM ribbons part So. 4 size 1/2-inch wide, 49 yards machine; 2560.

Columbia ribbon No. 33 Ribbons for Model 33 09137-01, 12 ribbons per Data Products 2400, 14 1/2 x 10 yards, black, P IBM typewriter ribbon keypunch, 3/16 inch x 11

## SITE SELECT

Notice of Po

**NOTICE IS HEREBY** Site Selection Board in accordance with Section 24-100 of the Charter, in City Hall, Borough of New York, on Monday, March 8, 1976, at 10 o'clock a. m., in the proposed sites:

Line No.	Project No.
868	PO 79 R

Proposed Site: The side of 94th Street and consists of Parcel 100 of the Borough of Queens, (SS)

Dated: New York City, New York, February 25, 1976.  
Room 1022, Municipal Building, New York 10007.

## MUNICIPAL ADMINISTRATION

DEPT. OF PUBLIC WORKS

SEALD BIDS The Department of Municipal Administration follows: Bids will be time, date and

Until 2:30 p. m., on

For furnishing and required construction work at construction site located at 56 East 59th Street, Manhattan, N. Y. 10036.

**NOTICE:** Bids will be opened on March 11, 1976, at 10 o'clock a. m., in accordance with the provisions of the Charter of the City of New York.

1601

C.P. 23248

APPROVED BY BOARD OF ESTIMATE  
CHANGAR # AMDT # 1224

DATE 8/19/76

HERMON A. MACNEIL PARK

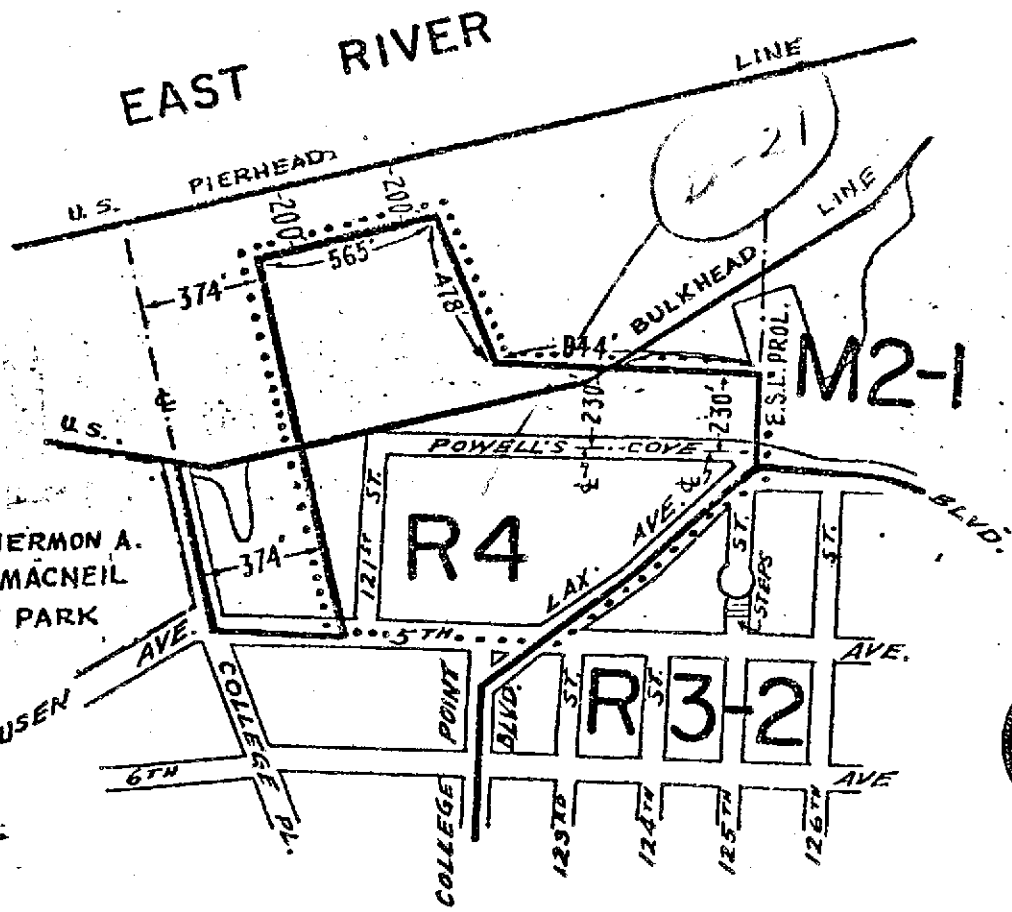

CITY PLANNING COMMISSION  
CITY OF NEW YORK  
DIAGRAM SHOWING PROPOSED  
ZONING CHANGE  
ON SECTIONAL MAP

7b

BOROUGH OF QUEENS

New York, June 1, 1976

*Richardson PE*  
Director, Division of Zoning

*John J. ... PE*  
Chief Engineer



NOTE:

- indicates Zoning District boundary.
- ..... The area enclosed by the fine dotted line is proposed to be changed from an M2-1 District to an R4 District.

C.H. 1/1

— 4 1/2 —

APPROVED BY BOARD OF ESTIMATE

CALENDAR # AMDT # 1223

DATE 8/19/76

C. P. 23263

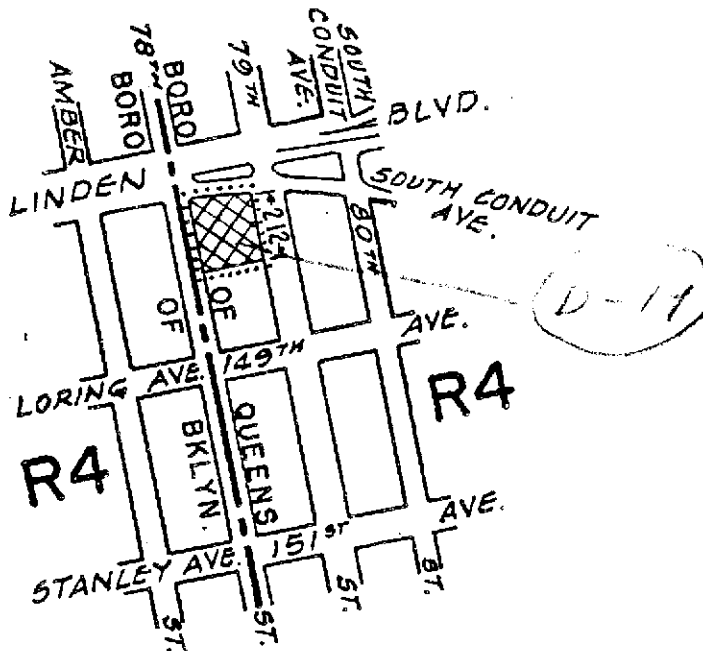

CITY PLANNING COMMISSION  
 CITY OF NEW YORK  
 DIAGRAM SHOWING PROPOSED  
 ZONING CHANGE  
 ON SECTIONAL MAP  
 18b



BOROUGH OF  
 QUEENS

New York, June 16, 1976

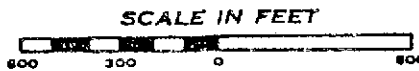
*J. Friedman* PE  
 Director, Division of Zoning  
*J. Trachten* PE  
 Chief Engineer



**NOTE:**

-  indicates Zoning District boundary.
-  The area enclosed by the fine dotted line is proposed to be changed from R4 to CI-2 by establishing a CI-2 District within an existing R4 District.
-  indicates a CI-2 District.

*H.C. 78T*

*Check of ...*

*To ...*

C.P. 23283

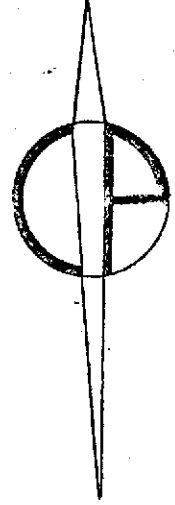
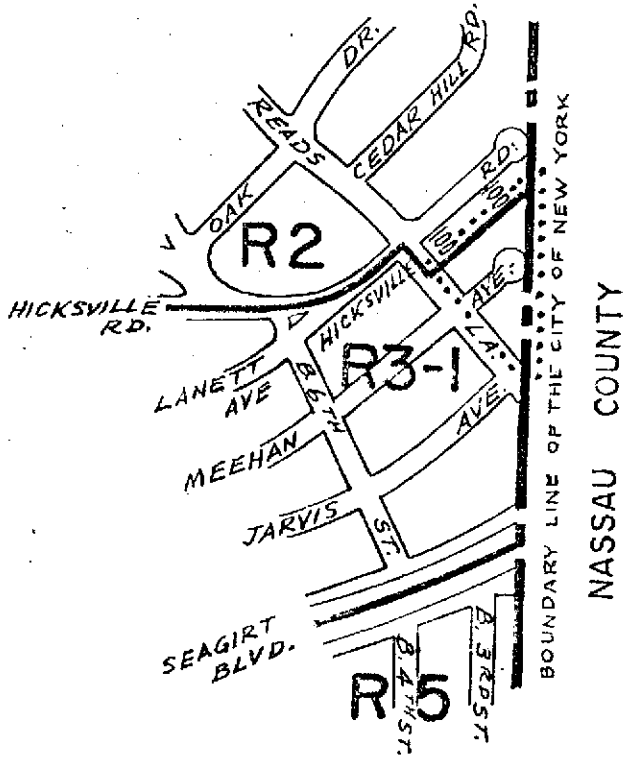
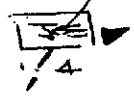

CITY PLANNING COMMISSION  
CITY OF NEW YORK  
DIAGRAM SHOWING PROPOSED  
ZONING CHANGE  
ON SECTIONAL MAP

31a

BOROUGH OF  
QUEENS

New York, June 30, 1976

*G. Friedman P.E.*  
Director, Division of Zoning  
*J. ... PE*  
Chief Engineer

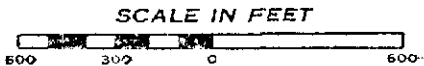

- NOTE:**
- \_\_\_\_\_ indicates Zoning District boundary.
  - ..... The area enclosed by the fine dotted line is proposed to be changed from an R-2 District to an R3-1 District.

APPROVED BY BOARD OF ESTIMATE

~~CALENDAR~~ # AMDT # 1225

DATE 9/16/76

*c. H.*

C760211ZMQ

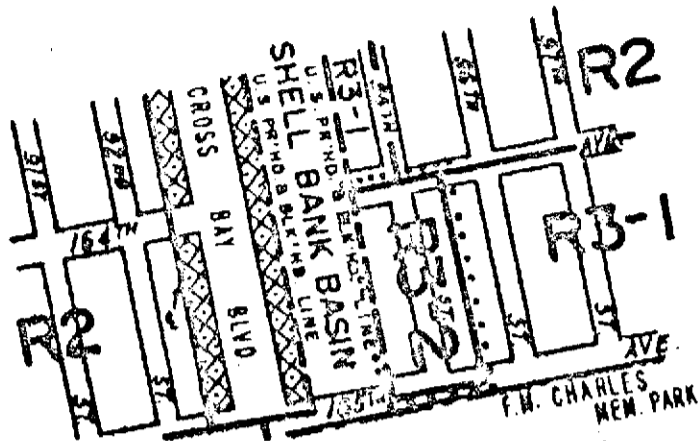

CITY PLANNING COMMISSION  
CITY OF NEW YORK  
**DIAGRAM SHOWING PROPOSED  
ZONING CHANGE  
ON SECTIONAL MAP  
18b**

BOROUGH OF  
QUEENS

Certification Date:  
New York, January 24, 1977

*J. Friedman PE*  
Director, Division of Zoning  
*J. J. ... PE*  
Chief Engineer

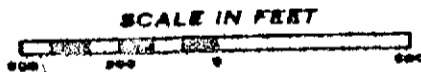

- NOTE:**
- indicates Zoning District boundary.
  - The area enclosed by the fine dotted line is proposed to be changed from a C3 District to an R3-2 District.
  - indicates a C2-2 District.

JLR 1/24/77

APPROVED BY BOARD OF ESTIMATE

CALENDAR # AMDT # 1233

DATE 7/21/77

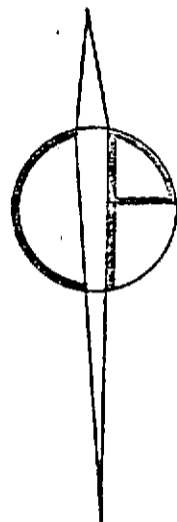
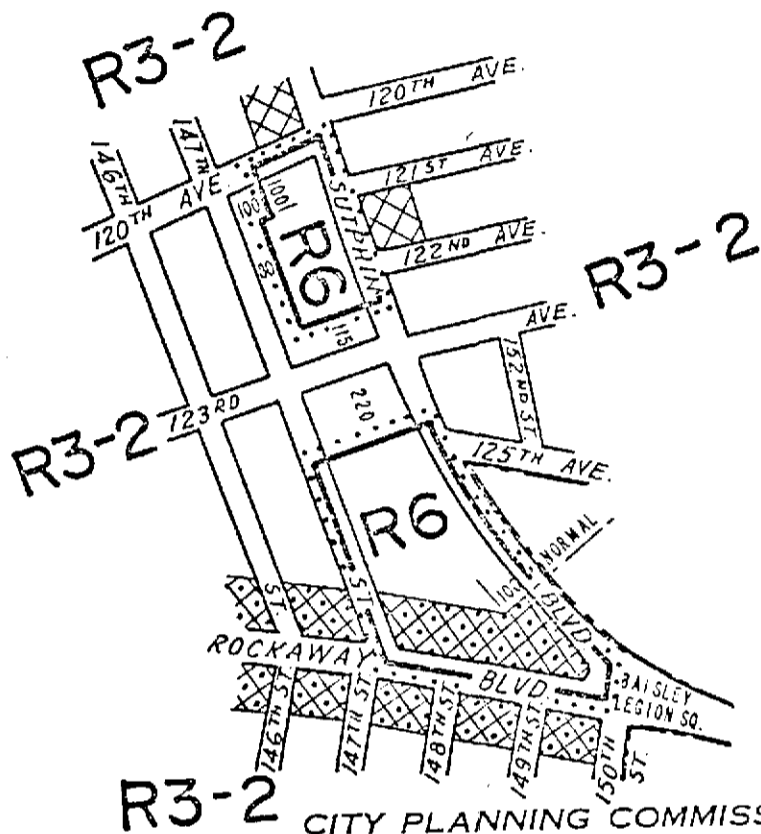

**R3-2 CITY PLANNING COMMISSION  
CITY OF NEW YORK  
DIAGRAM SHOWING PROPOSED  
ZONING CHANGE  
ON SECTIONAL MAP  
18c  
BOROUGH OF  
QUEENS**

Certification date  
New York, October 24, 1977

*Israel J. Gorman*  
Director, Division of Zoning  
*James J. Frick* P.E.  
Chief Engineer

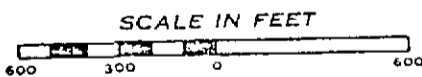

- NOTE:**
- indicates Zoning District boundary.
  - The area enclosed by the fine dotted line is proposed to be changed from an R3-2 District to an R6 District.
  - indicates a C1-2 District.
  - indicates a C2-2 District.

JRG

APPROVED BY BOARD OF ESTIMATE  
CALENDAR # AMDT # 1245  
DATE 4/20/78

COLLECTION  
D-37

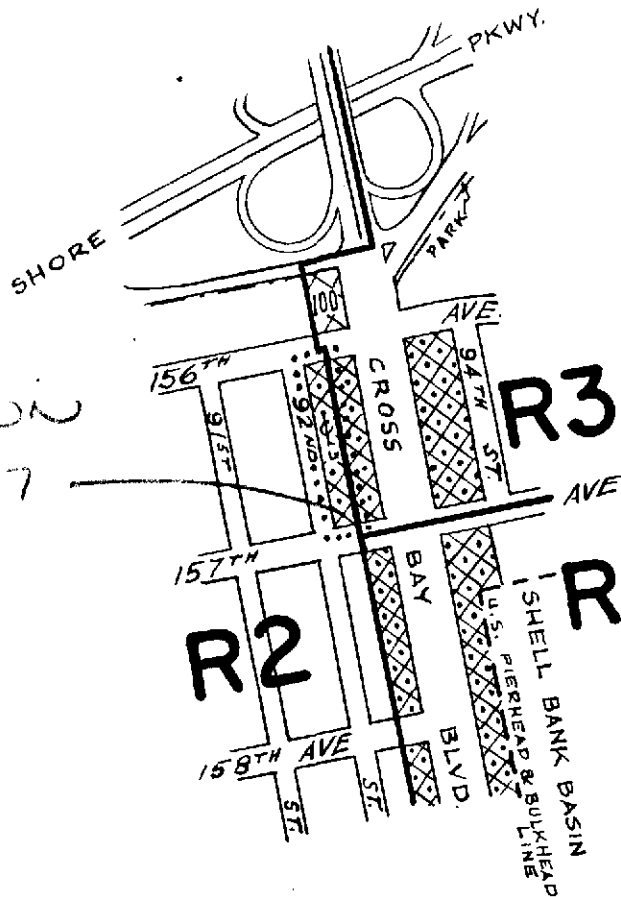

15/12/78

CITY PLANNING COMMISSION  
CITY OF NEW YORK  
DIAGRAM SHOWING PROPOSED  
ZONING CHANGE  
ON SECTIONAL MAP

18 b  
BOROUGH OF  
QUEENS

Certification Date  
New York, April 10, 1978

APPROVED BY BOARD OF ESTIMATE

CALENDAR # AMRT # 1254

DATE 9/14/78

*Israel Howe*, PE.  
Director of Zoning  
*Jim. Froelich* PE  
Chief Engineer

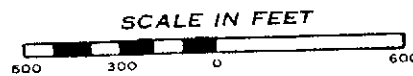

NOTE:

- indicates Zoning District boundary.
- The area enclosed by the fine dotted line is proposed to be changed by establishing a C2-2 District within an existing R2 District.
- indicates a C1-2 District.
- indicates a C2-2 District.



APPROVED BY BOARD OF ESTIMATE

CALENDAR # AMOT # 1257

DATE 9/28/78

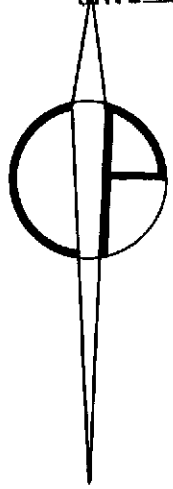

R4

R4

MI-1

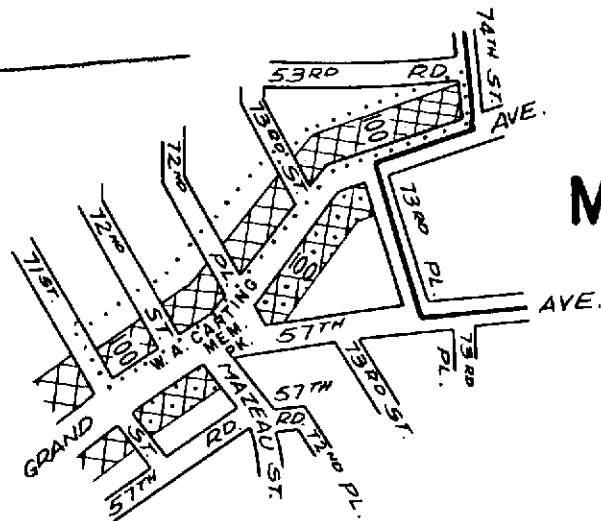

R4

CITY PLANNING COMMISSION  
CITY OF NEW YORK  
DIAGRAM SHOWING PROPOSED  
ZONING CHANGE  
ON SECTIONAL MAP



13c  
BOROUGH OF  
QUEENS

Certification date  
New York, May 22, 1978  
Modified September 11, 1978  
Cal. No. 2

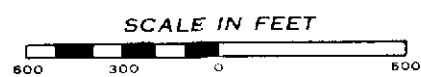
*J. Friedman* PE  
Dep Director, Division of Zoning  
*J. Frantz* PE  
Chief Engineer



**NOTE:**  
———— indicates Zoning District boundary.  
..... The area enclosed by the fine dotted line is proposed to be changed by eliminating C2-2 Districts within an existing R4 District and by establishing C1-2 Districts within an existing R4 District.

 indicates a C1-2 District.  
 indicates a C2-2 District.

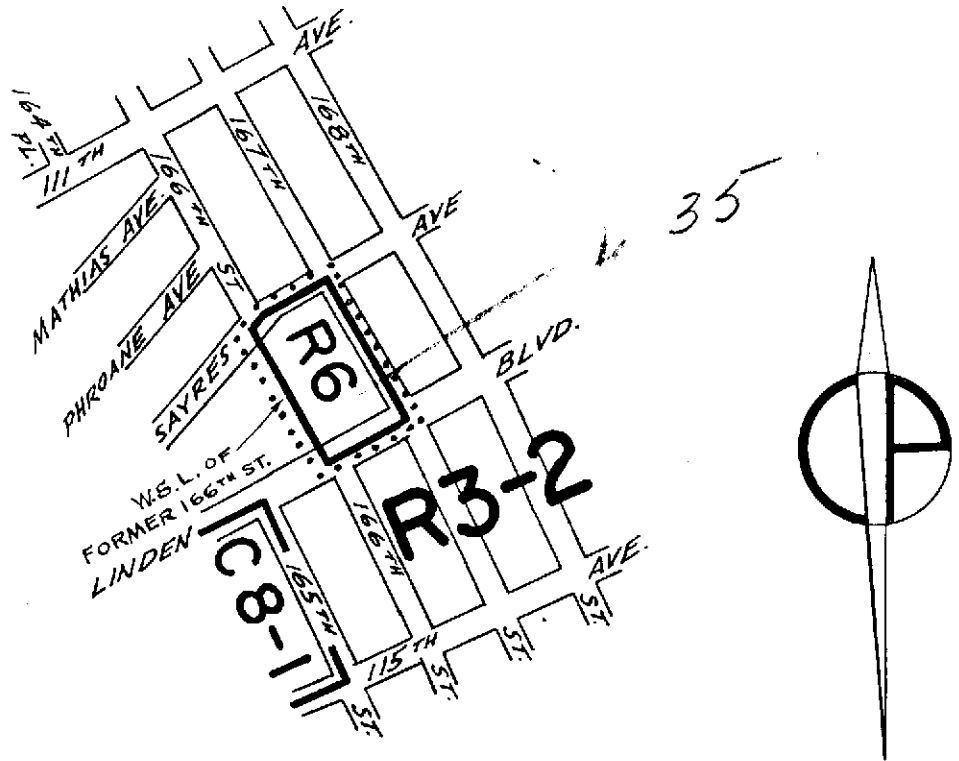

CITY PLANNING COMMISSION  
 CITY OF NEW YORK  
**DIAGRAM SHOWING PROPOSED  
 ZONING CHANGE  
 ON SECTIONAL MAP**

**18c**  
 BOROUGH OF  
 QUEENS

Certification Date  
 New York, June 12, 1978

*Zorabian, Jr.*  
 Director of Zoning  
*James J. ...*  
 Chief Engineer



- NOTE:**
- indicates Zoning District boundary.
  - .....** The area enclosed by the fine dotted line is proposed to be changed from an R3-2 District to an R6 District.

APPROVED BY BOARD OF ESTIMATE

~~CALENDAR~~ # AMDT # 1256

DATE 9/28/78

C.D.4

C 780188 ZMQ

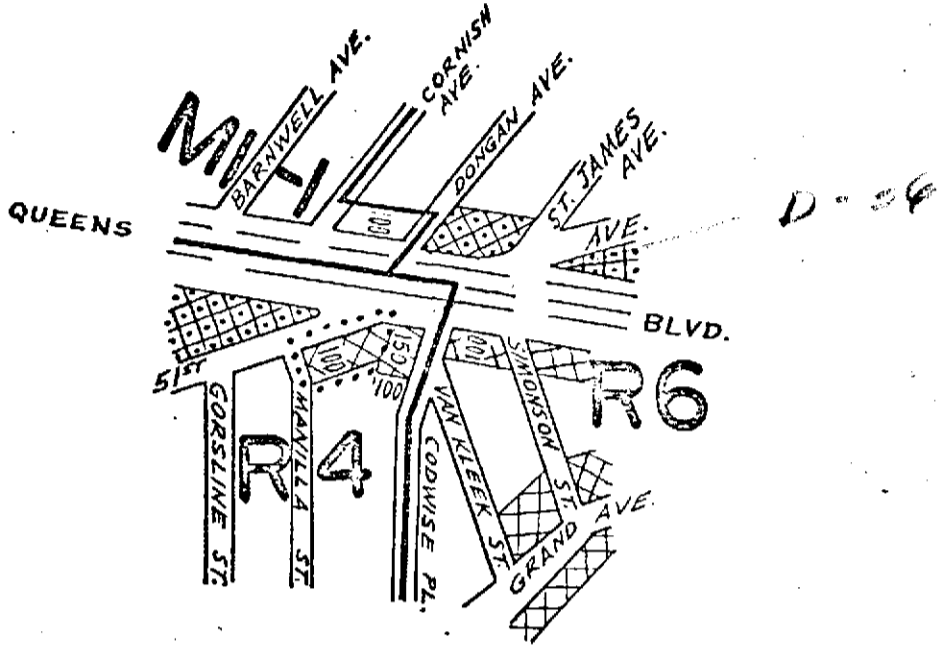

CITY PLANNING COMMISSION  
 CITY OF NEW YORK  
 DIAGRAM SHOWING PROPOSED  
 ZONING CHANGE  
 ON SECTIONAL MAP  
 13c  
 BOROUGH OF  
 QUEENS

Certification Date  
 New York, June 19, 1978

*Joseph P. ...* P.E.  
 Director of Zoning  
*James ...* P.E.  
 Chief Engineer

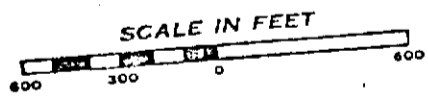

- NOTE:**
- indicates Zoning District boundary.
  - The area enclosed by the fine dotted line is proposed to be changed by establishing a CI-2 District within an existing R4 District.
  - indicates a CI-2 District.

APPROVED BY BOARD OF ESTIMATE  
~~CALENDAR #~~ AMDT # 1262  
 DATE 11/16/78

C.H.

C780188ZMQ

R4

R4

R4

R4

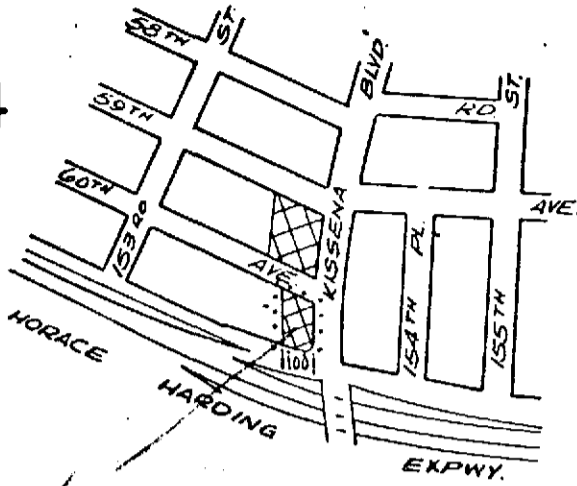
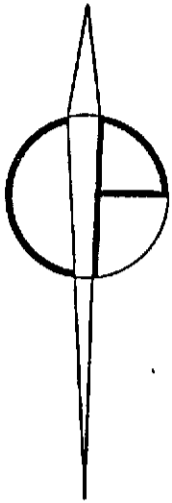

CITY PLANNING COMMISSION  
CITY OF NEW YORK  
DIAGRAM SHOWING PROPOSED  
ZONING CHANGE  
ON SECTIONAL MAP

10d  
BOROUGH OF  
QUEENS

Certification Date  
New York, July 10, 1978

*Israel Yerman, P.E.*  
Director, Division of Zoning  
*Jim Mueller, P.E.*  
Chief Engineer

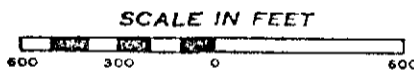

NOTE:

- indicates Zoning District boundary.
- The area enclosed by the fine dotted line is proposed to be changed by establishing a CI-2 District within an existing R4 District.
- indicates a CI-2 District.

A. J. P.

APPROVED BY BOARD OF ESTIMATE

CALENDAR # AMDT # 1263

DATE 12/7/78

CD 7

C780287 ZMQ

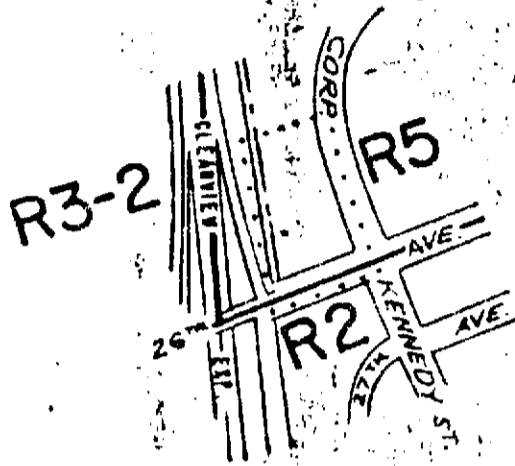

CITY PLANNING COMMISSION  
 CITY OF NEW YORK  
 DIAGRAM SHOWING PROPOSED  
 ZONING CHANGE  
 ON SECTIONAL MAP

10c  
 BOROUGH OF  
 QUEENS

Certification Date  
 New York, Nov. 27, 1978

Secretary

*Israel Rosen*, P.E.  
 Director, of Zoning

*Julius Specter*, P.E.  
 Chief, Engineer

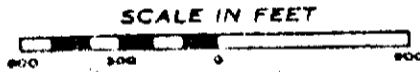

NOTE:

- indicates Zoning District boundary.
- ..... The area enclosed by the fine dotted line is proposed to be changed from an R2 District to an R5 District.

R.P.

APPROVED BY BOARD OF ESTIMATE

CALENDAR # 24

DATE 5-24-79

AMDT. # 1266

C780287ZMQ

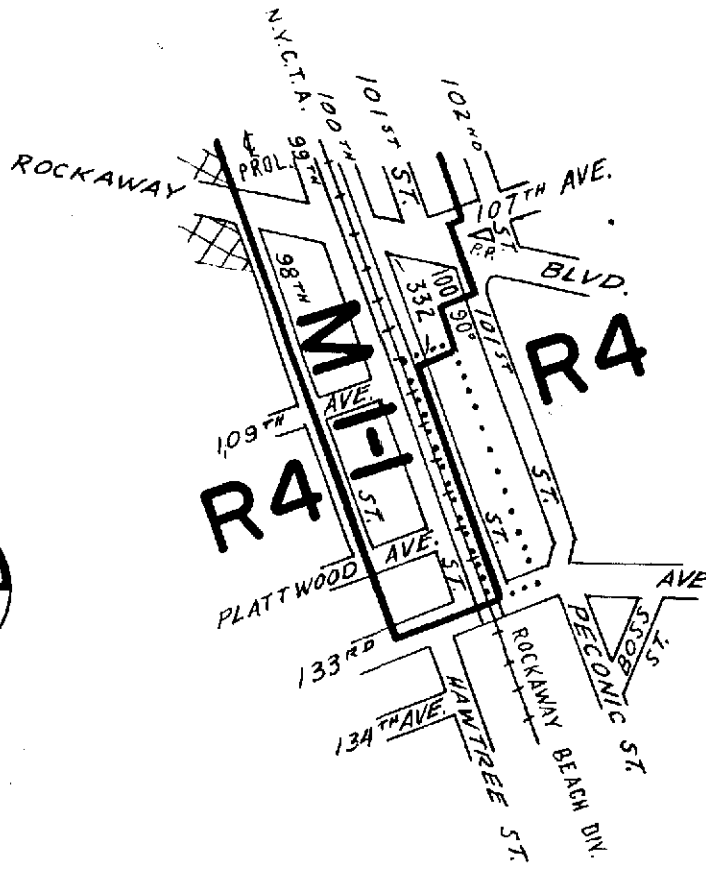
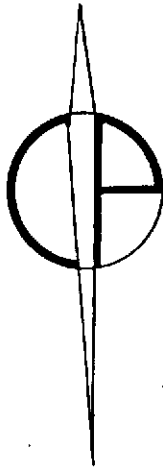

APPROVED BY BOARD OF ESTIMATE

CALENDAR # 17

DATE 3-8-79

AMDT. # 1265

CITY PLANNING COMMISSION  
 CITY OF NEW YORK  
**DIAGRAM SHOWING PROPOSED  
 ZONING CHANGE  
 ON SECTIONAL MAP**

18a

BOROUGH OF  
QUEENS

Certification Date  
New York, October 16, 1978

*Donald R. ...* P.I.  
 Director of Zoning

*Julius Specter* PE  
 Act. Chief Engineer

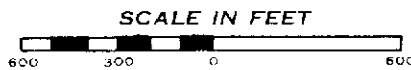

**NOTE:**

- indicates Zoning District boundary.
- The area enclosed by the fine dotted line is proposed to be changed from an MI-1 District to an R4 District.
- indicates a C1-2 District.

(6515)

C.D.10

C 780550 ZMQ

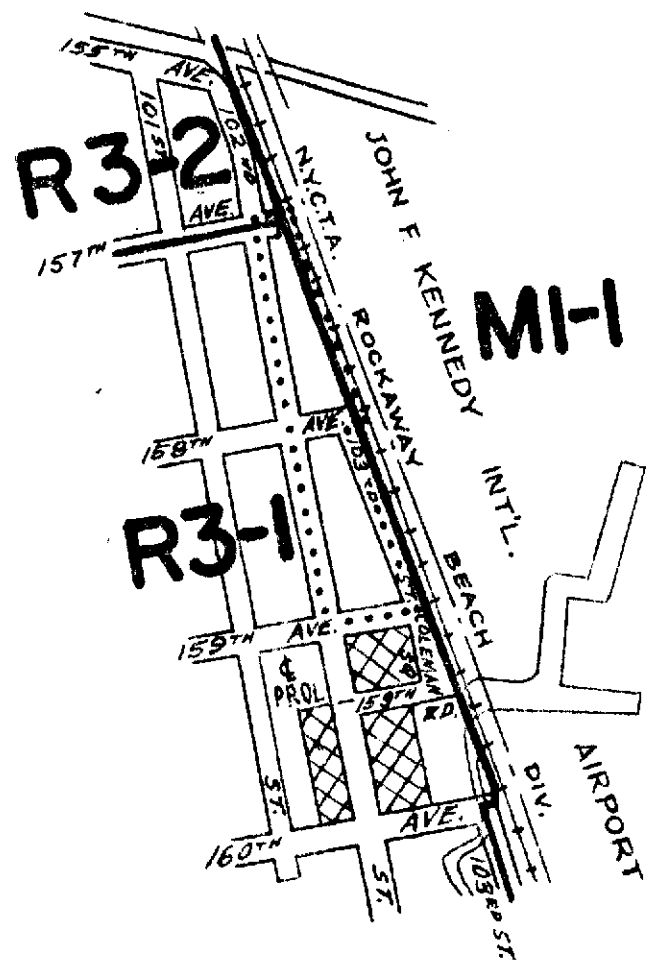
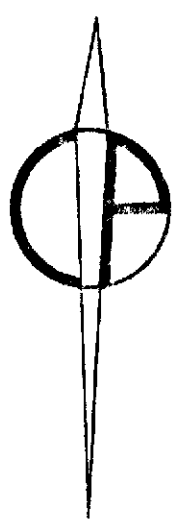

APPROVED BY BOARD OF ESTIMATE

CALENDAR # 29

DATE 6-8-79

AMDT # 1268

CITY PLANNING COMMISSION  
 CITY OF NEW YORK  
**DIAGRAM SHOWING PROPOSED  
 ZONING CHANGE  
 ON SECTIONAL MAP**

18b

BOROUGH OF  
QUEENS

Certification Date  
New York, January 22, 1979

*[Signature]*  
 Director of Zoning  
*[Signature]* P.E.  
 Chief Engineer



**NOTE:**

- indicates Zoning District boundary.
- The area enclosed by the fine dotted line is proposed to be changed by eliminating a CI-2 District from within an existing R3-1 District
- indicates a CI-2 District.

C.D.3

9c/10a

C790347 ZMO

D-43

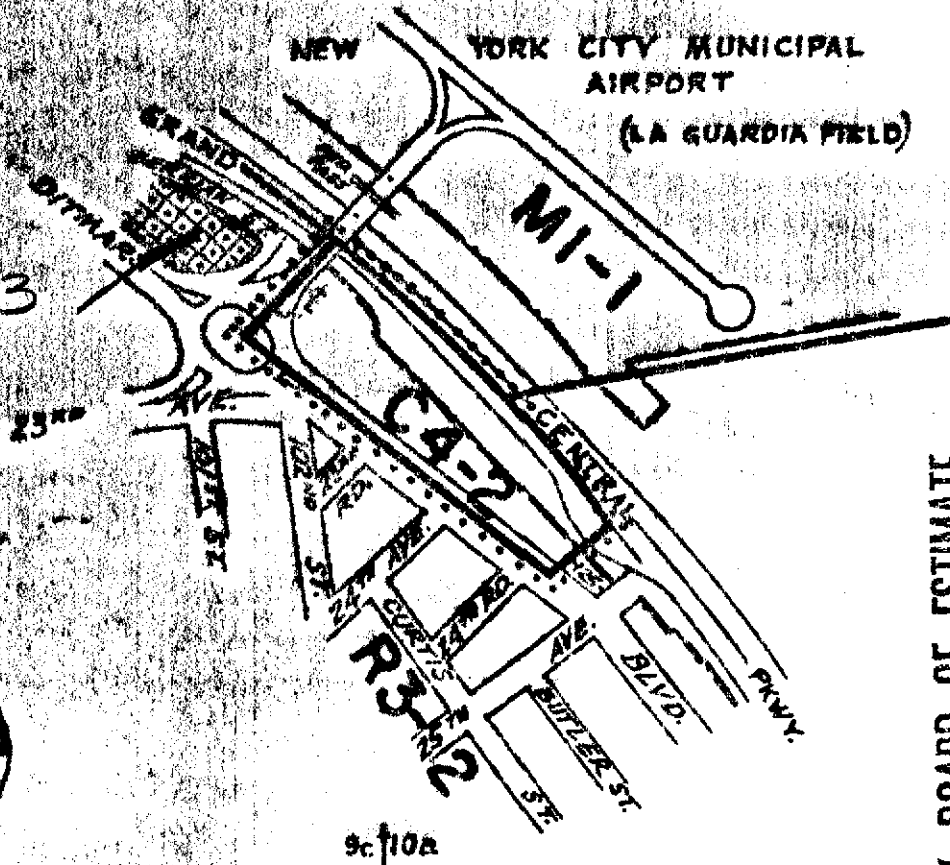

CITY PLANNING COMMISSION  
 CITY OF NEW YORK  
**DIAGRAM SHOWING PROPOSED  
 ZONING CHANGE  
 ON SECTIONAL MAPS**

**9c & 10a**  
 BOROUGH OF  
 QUEENS

Certification Date  
 New York, June 11, 1979

*Jacob [Signature]* PE.  
 Director of Zoning  
*Jalun Specter* PE  
 Chief Engineer



- NOTE:**
- indicates Zoning District boundary.
  - The area enclosed by the fine dotted line is proposed to be changed from an R3-2 District to a C4-2 District.
  - indicates a C2-2 District.

APPROVED BY BOARD OF ESTIMATE

CALENDAR # 36  
 DATE AUG. 16, 1979  
 AMT. # 1272

CH. AD



APPROVED BY BOARD OF ESTIMATE

CALENDAR # 83

DATE 12-6-79

A-1277

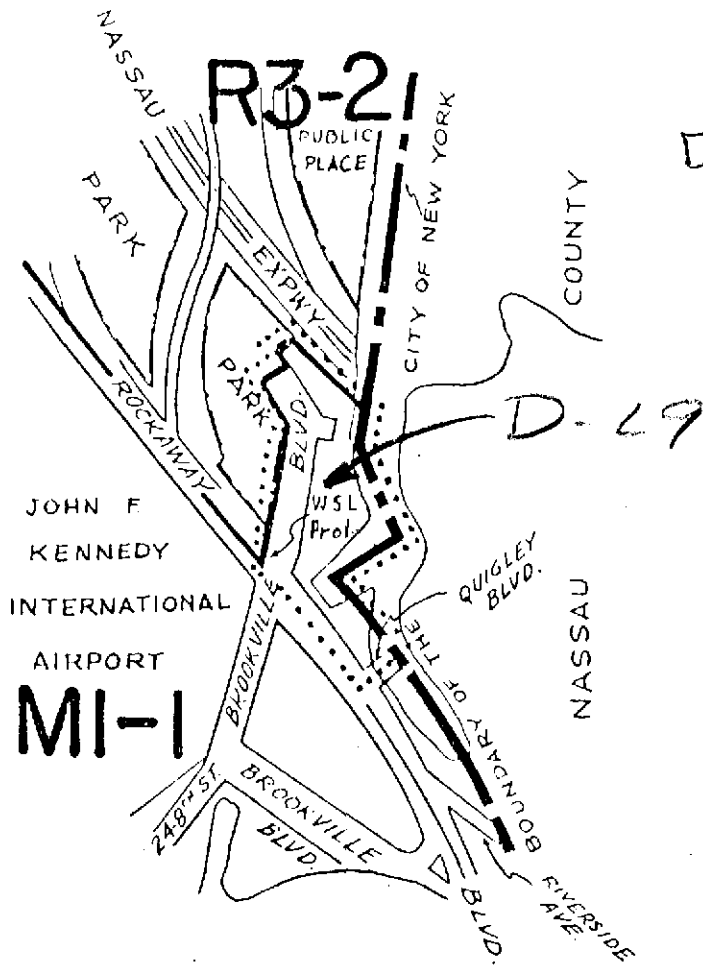

CITY PLANNING COMMISSION  
 CITY OF NEW YORK  
 DIAGRAM SHOWING PROPOSED  
 ZONING CHANGE  
 ON SECTIONAL MAP

25a

BOROUGH OF QUEENS

Certification Date  
New York October 3, 1977

*Israel Gorman* P.E.  
 Director, Division of Zoning  
*Jim Smith* AS  
 Chief Engineer

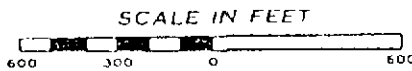

NOTE:

- indicates Zoning District boundary.
- ..... The area enclosed by the fine dotted line is proposed to be changed from an R3-2 District to an MI-1 District.

D46

63

C.D.7

C790065 ZMQ

# EAST RIVER

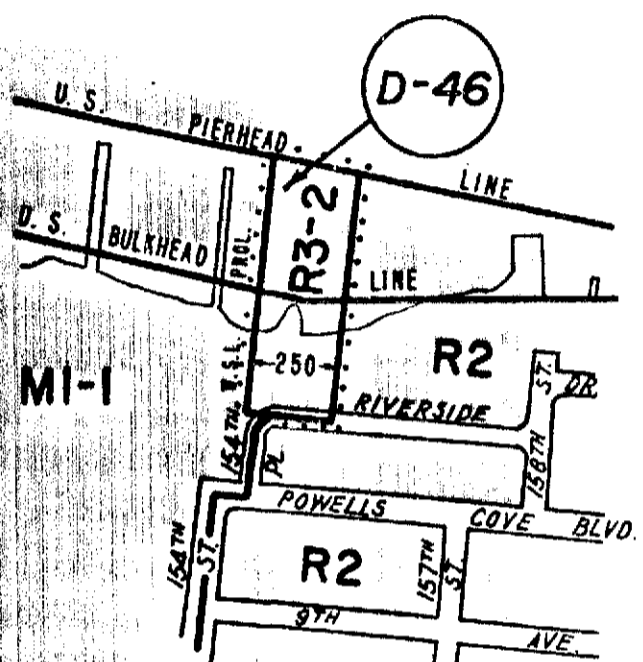

CITY PLANNING COMMISSION  
 CITY OF NEW YORK  
**DIAGRAM SHOWING PROPOSED  
 ZONING CHANGE  
 ON SECTIONAL MAP  
 7d  
 BOROUGH OF  
 QUEENS**

New York, June 4, 1979

*[Signature]*  
 Director, Division of Zoning  
*[Signature]*  
 Chief Engineer

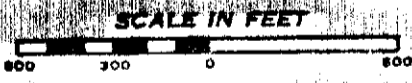

**NOTE:**  
 — indicates Zoning District boundary.  
 ..... The area enclosed by the fine dotted line is proposed to be changed from  
 an MI-1 District to an R3-2 District.  
 (D-46) — indicates a Restrictive Declaration.

K HR AP 44 47/1

APPROVED BY BOARD OF ESTIMATE

CALENDAR # 37

DATE 12-6-79

A-1274

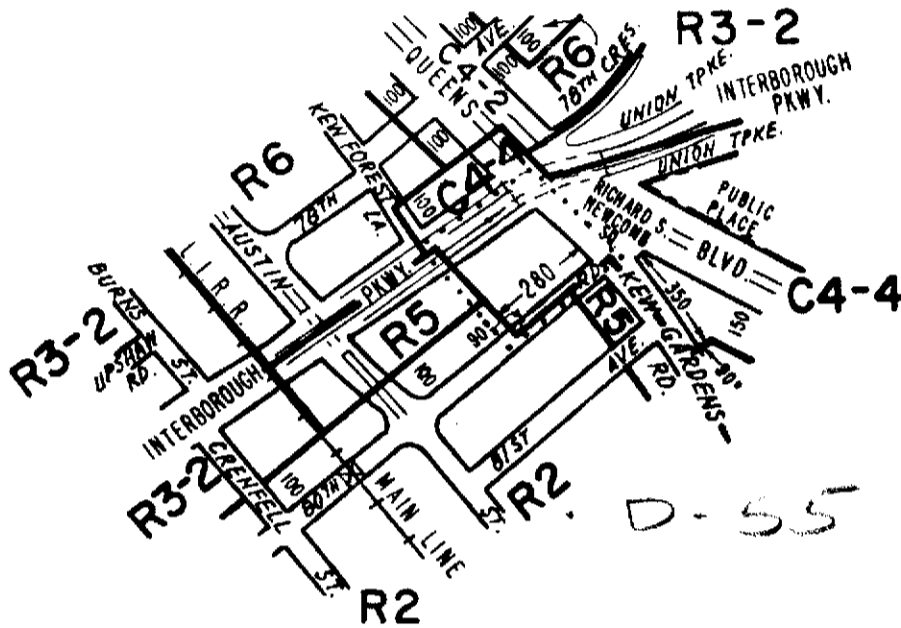

CITY PLANNING COMMISSION  
 CITY OF NEW YORK  
**DIAGRAM SHOWING PROPOSED  
 ZONING CHANGE  
 ON SECTIONAL MAP**

14b

BOROUGH OF  
QUEENS

Certification Date:  
 New York, December 10, 1979  
 Modified: April 21, 1980

Secretary

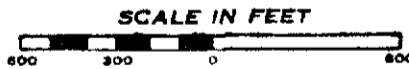

- NOTE:**
- Indicates Zoning District boundary.
  - ..... The area enclosed by the fine dotted line is proposed to be changed from on R5 District to a C4-4 District.

APPROVED BY BOARD OF ESTIMATE

CALENDAR # 173

DATE 1-14-82

ATTN: SEE A-1287

*[Signature]* P.E.  
 Director, Division of Zoning

Dep. Chief Engineer  
*[Signature]* P.E.

JLR

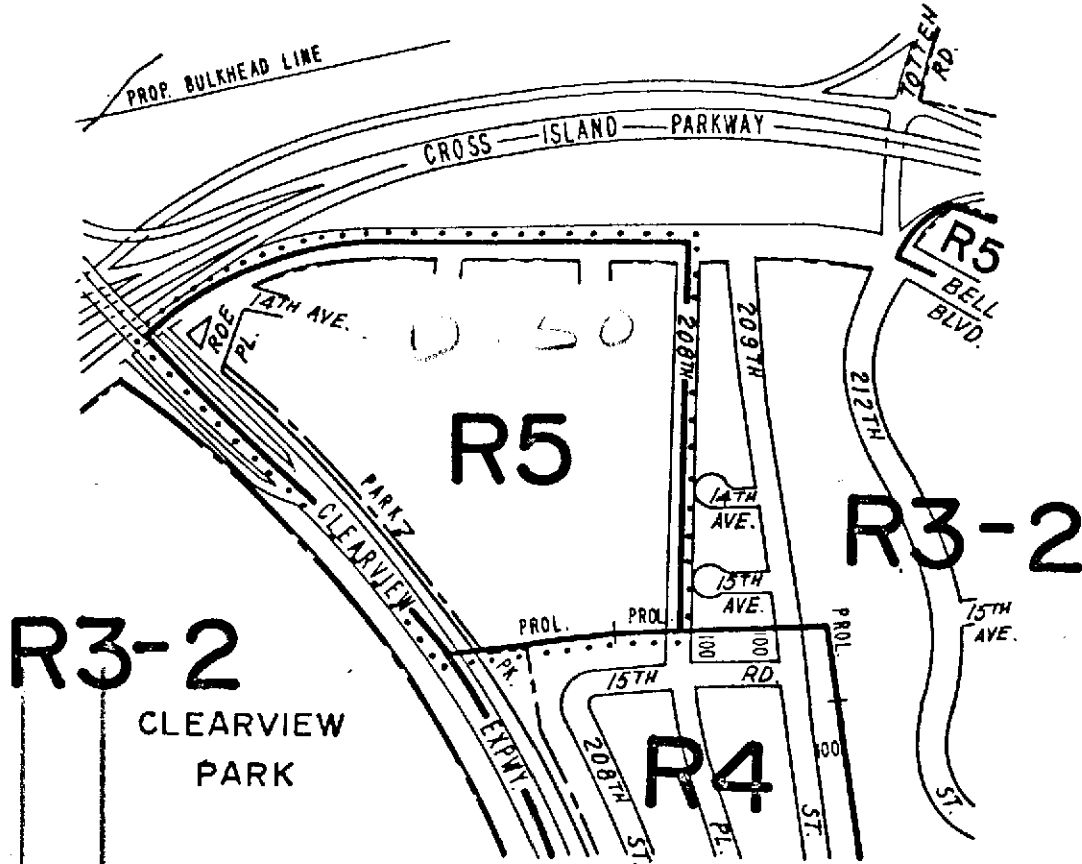

APPROVED BY BOARD OF ESTIMATE

CALCULATION # 51

DATE 2-21-80

A # 1283

New York, August 20, 1979

CITY PLANNING COMMISSION  
 CITY OF NEW YORK  
 DIAGRAM SHOWING PROPOSED  
 ZONING CHANGE  
 ON SECTIONAL MAP

7d

BOROUGH OF  
QUEENS

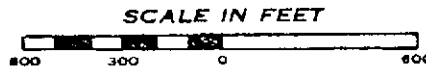

NOTE:

- \_\_\_\_\_ indicates Zoning District boundary.
- ..... The area enclosed by the fine dotted line is proposed to be changed from an MI-1 District to an R5 District.

*Israel K...* P.E.  
 Director, Division of Zoning

*Julius G...* P.E.  
 Chief Engineer

MAR 1 1980

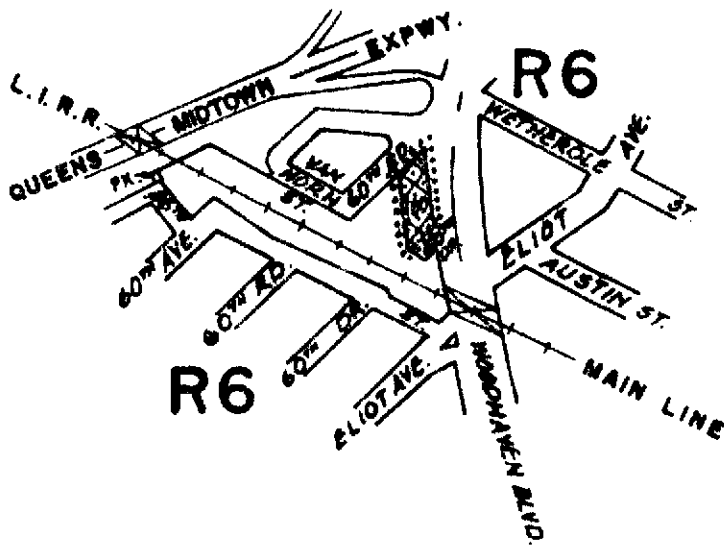

CITY PLANNING COMMISSION  
 CITY OF NEW YORK  
**DIAGRAM SHOWING PROPOSED  
 ZONING CHANGE  
 ON SECTIONAL MAP**

**13c**



**BOROUGH OF  
 QUEENS**

**Certification Date:**  
 New York, July 21, 1980

Director, Division of Zoning



Chief Engineer

- NOTE:**
-  indicates Zoning District boundary.
  -  The area enclosed by the fine dotted line is proposed to be changed by establishing a C2-2 District within an existing R6 District.
  -  indicates a C2-2 District.

*He*

**APPROVED BY BOARD OF ESTIMATE**

CALENDAR # 15

DATE 12-18-80

A-1300

C.D. 1

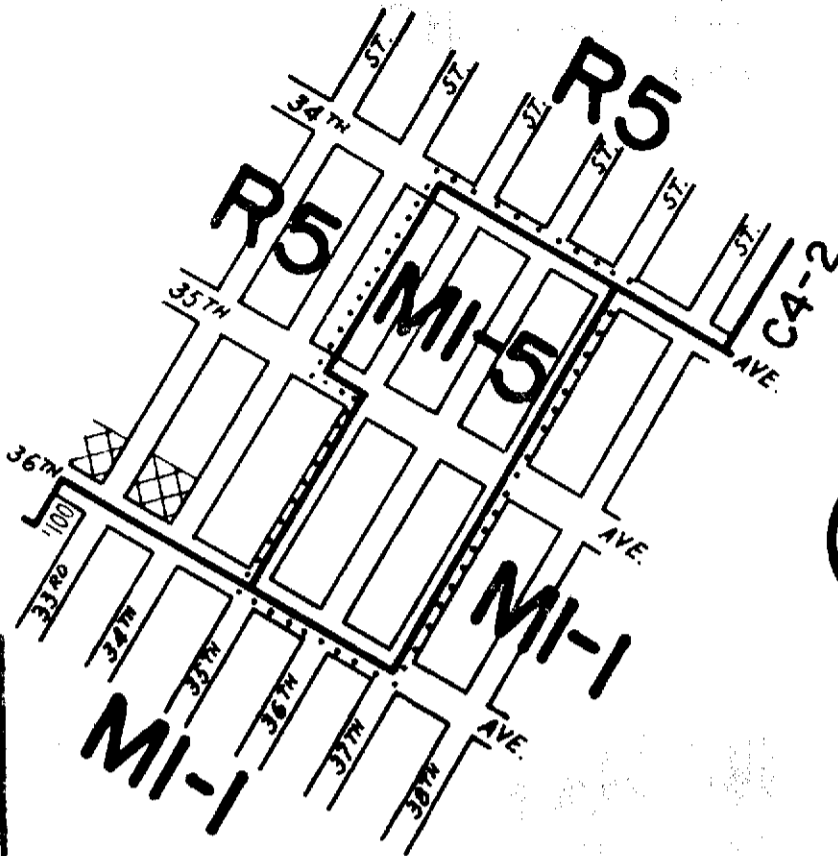

APPROVED BY BOARD OF ESTIMATE

CALENDAR # 26

DATE 2-26-81

A-1307

CITY PLANNING COMMISSION  
 CITY OF NEW YORK  
**DIAGRAM SHOWING PROPOSED  
 ZONING CHANGE  
 ON SECTIONAL MAP**

9b

BOROUGH OF  
QUEENS



Certification Date:  
 New York, October 27, 1980

*Israel...* P.E.  
 Director, Division of Zoning

*Julius Spill...* P.E.  
 Chief Engineer



**NOTE:**

-  indicates Zoning District boundary.
-  The area enclosed by the fine dotted line is proposed to be changed from an MI-1 District to an MI-5 District.
-  indicates a C1-2 District.

364

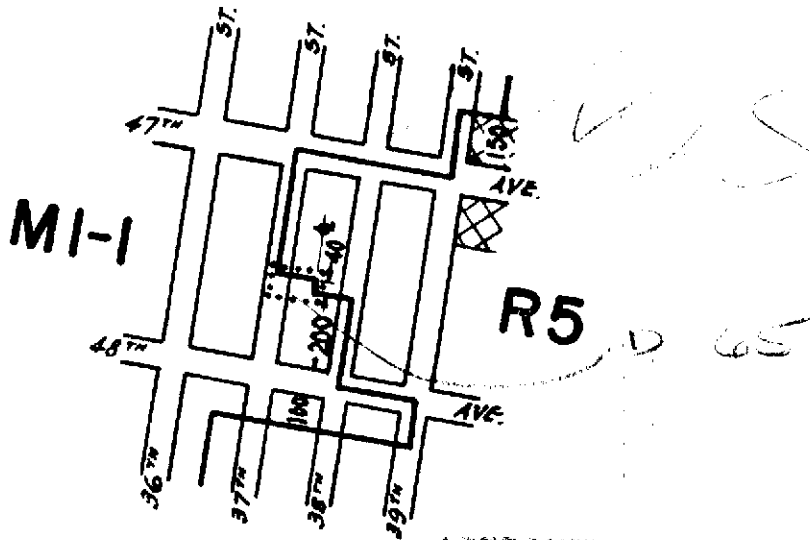

APPROVED BY BOARD OF ESTIMATE

CALENDAR # 1 43

DATE 5-28-81

CITY PLANNING COMMISSION A-1311  
CITY OF NEW YORK

DIAGRAM SHOWING PROPOSED  
ZONING CHANGE  
ON SECTIONAL MAP

9b

BOROUGH OF  
QUEENS

Certification Date  
New York, December 1, 1980

*Israel Guma* P.E.  
Director, Division of Zoning

*Julius Gato* P.E.  
Chief Engineer



NOTE:

- indicates Zoning District boundary.
- The area enclosed by the fine dotted line is proposed to be changed from an R5 District to an MI-1 District.
- indicates a C1-2 District.

*A.C.*

APPROVED BY BOARD OF ESTIMATE

CALENDAR # 63

DATE 8-20-81

A-1317

D-60

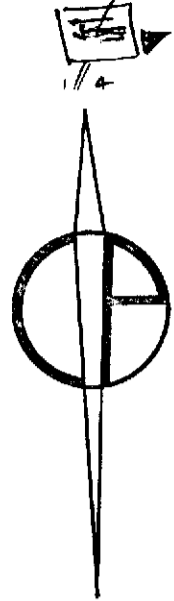
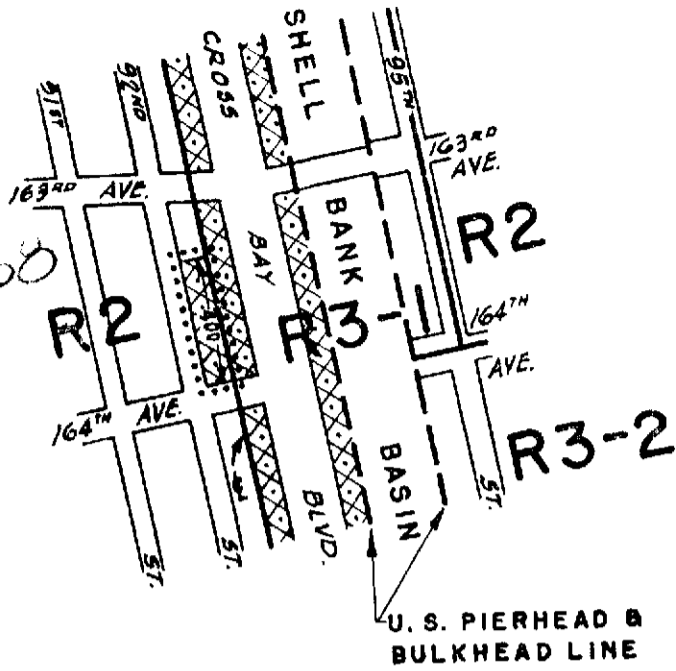

CITY PLANNING COMMISSION  
 CITY OF NEW YORK  
 DIAGRAM SHOWING PROPOSED  
 ZONING CHANGE  
 ON SECTIONAL MAP

**18b**  
 BOROUGH OF  
 QUEENS

Certification Date:  
 New York, March 9, 1981

*Anthony Patrician, P.E.*  
 Acting Director, Division of Zoning  
*Julius Specter, P.E.*  
 Chief Engineer

Secretary



**NOTE:**

- indicates Zoning District boundary.
- The area enclosed by the fine dotted line is proposed to be changed by establishing a C2-2 District within an existing R2 District.
- Indicates a C2-2 District.

J.C.





D-69

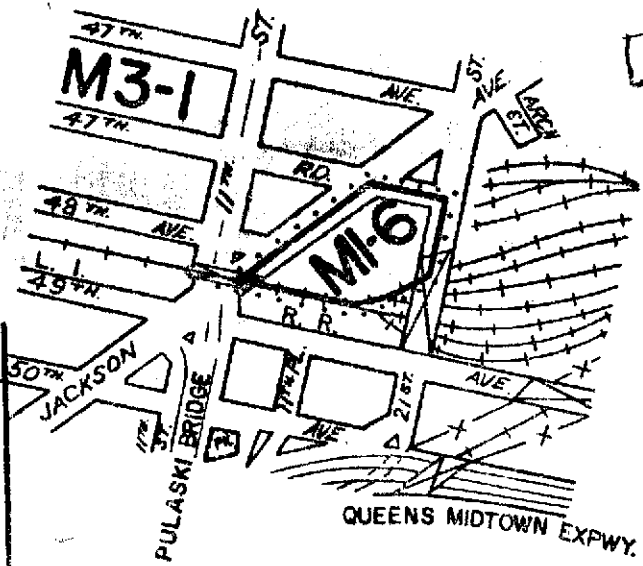

APPROVED BY BOARD OF ESTIMATE

CALENDAR # 65

DATE 8-20-81

A-1321

CITY PLANNING COMMISSION  
CITY OF NEW YORK  
DIAGRAM SHOWING PROPOSED  
ZONING CHANGE  
ON SECTIONAL MAP

9b

BOROUGH OF  
QUEENS

Certification Date  
New York, May 26, 1981

*Anthony J. Patino, P.E.*  
Acting Director of Zoning  
*Julius Specter, P.E.*  
Chief Engineer

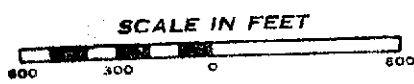

NOTE:  
———— indicates Zoning District boundary.  
..... The area enclosed by the fine dotted line is proposed to be changed from an M3-1 District to an MI-6 District.

RC RP

~~HOLD OFF —  
SHEET WENT OUT  
WITH DIFFERENT DATE~~

CALENDAR # 49

12-3-81

A-1331

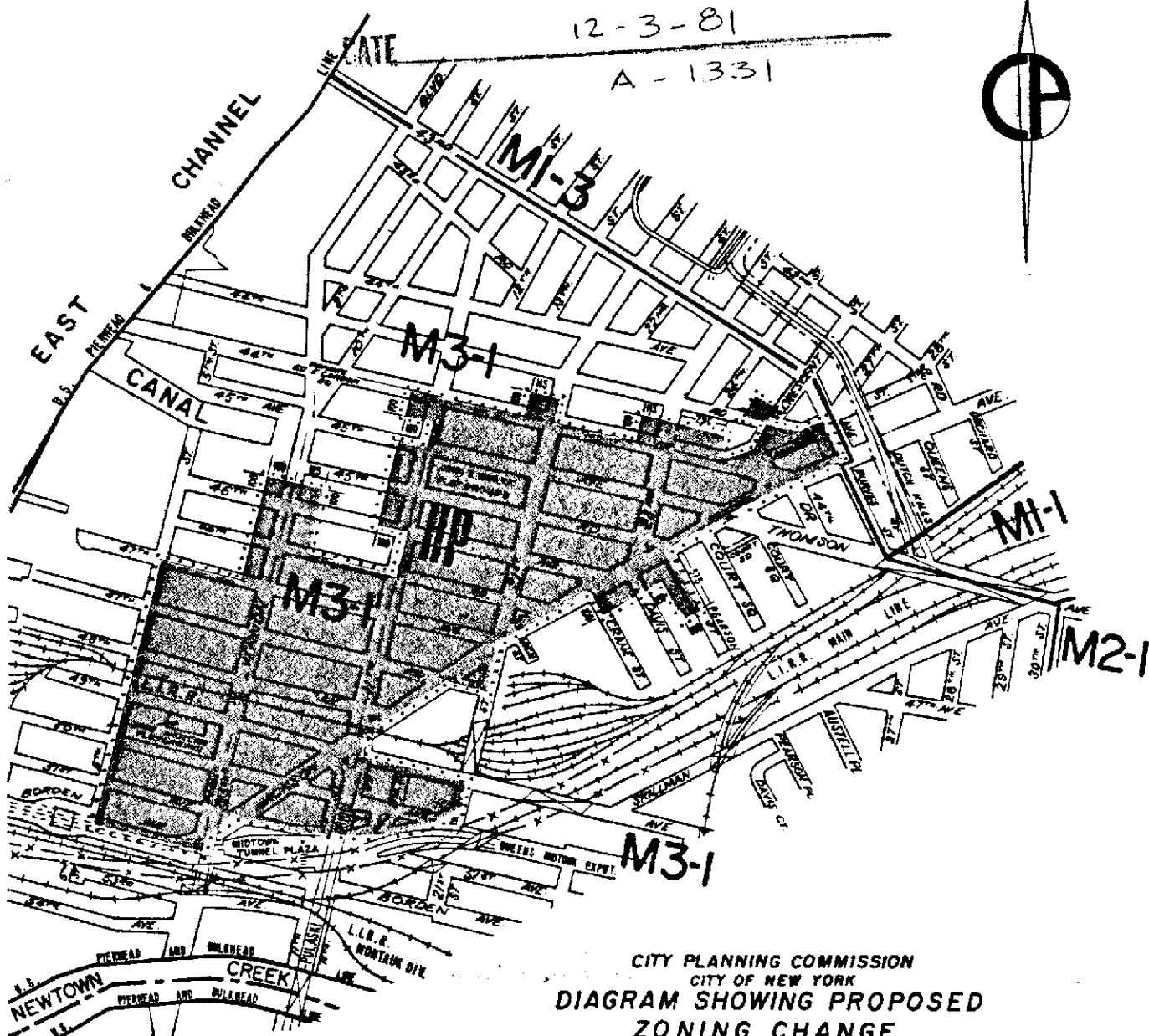

CITY PLANNING COMMISSION  
CITY OF NEW YORK  
DIAGRAM SHOWING PROPOSED  
ZONING CHANGE  
ON SECTIONAL MAP

9b  
BOROUGH OF  
QUEENS

Certification Date  
New York June 22, 1981

*Malcolm R. ...*, RE.  
Director of Zoning  
and  
*...*  
Civil Engineer



- NOTE:
- indicates Zoning District boundary.
  - ..... The area enclosed by the fine dotted line is the Hunter's Point Mixed Use District proposed to be established.
  - HP** Indicates Hunter's Point Mixed Use District.

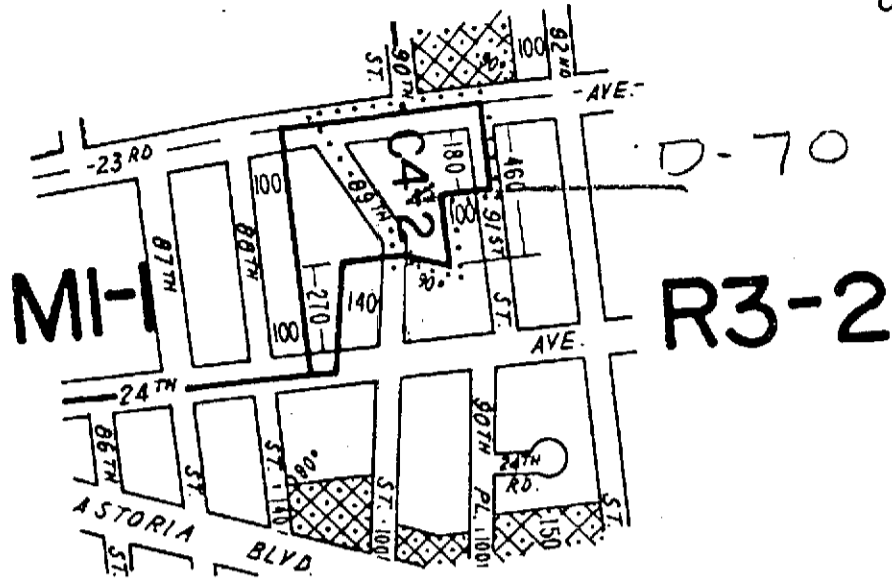
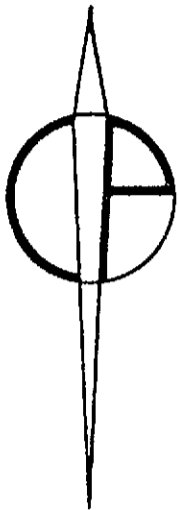

CITY PLANNING COMMISSION  
 CITY OF NEW YORK  
 DIAGRAM SHOWING PROPOSED  
 ZONING CHANGE  
 ON SECTIONAL MAP

9c  
 BOROUGH OF  
 QUEENS

Certification Date:  
 New York, June 22, 1981

*Israel Forman* P.E.  
 Director, Division of Zoning  
*Julius Spector* P.E.  
 Chief Engineer



NOTE:

- indicates Zoning District boundary.
- The area enclosed by the fine dotted line is proposed to be changed from an R3-2 District to a C4-2 District.
- indicates a C2-2 District.

APPROVED BY BOARD OF ESTIMATE

CALENDAR # 50

DATE 12-3-81  
A-1332

JAC

APPROVED BY BOARD OF ESTIMATE

CALENDAR # 170

DATE 4-14-88

CHANGE IN RESTRICTIVE  
 DECLARATION ONLY.

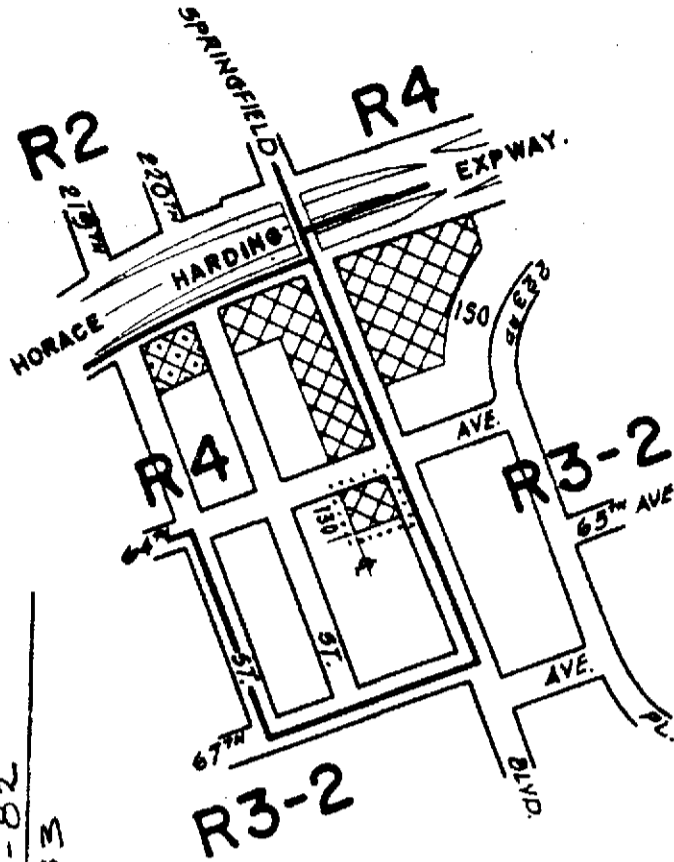

APPROVED BY BOARD OF ESTIMATES

CALENDAR # # 36

DATE 1-14-82

A-1333

CITY PLANNING COMMISSION  
 CITY OF NEW YORK  
**DIAGRAM SHOWING PROPOSED  
 ZONING CHANGE  
 ON SECTIONAL MAP**

**11b**

**BOROUGH OF  
 QUEENS**

**Certification Date:**  
 New York, **August 31, 1981**

*Anthony J. Patino, P.E.*  
 Acting Director, Division of Zoning

*Julius Specter, P.E.*  
 Chief Engineer

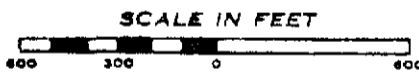

**NOTE:**

- indicates Zoning District boundary.
- The area enclosed by the fine dotted line is proposed to be changed by establishing a C1-2 District within an existing R4 District.
- indicates a C1-2 District.
- indicates a C2-2 District.

*A.C.*

C. D. 3,4,7

C810425ZM0

APPROVED BY BOARD OF ESTIMATE

CALENDAR # 23

DATE 2-11-82  
A-1337

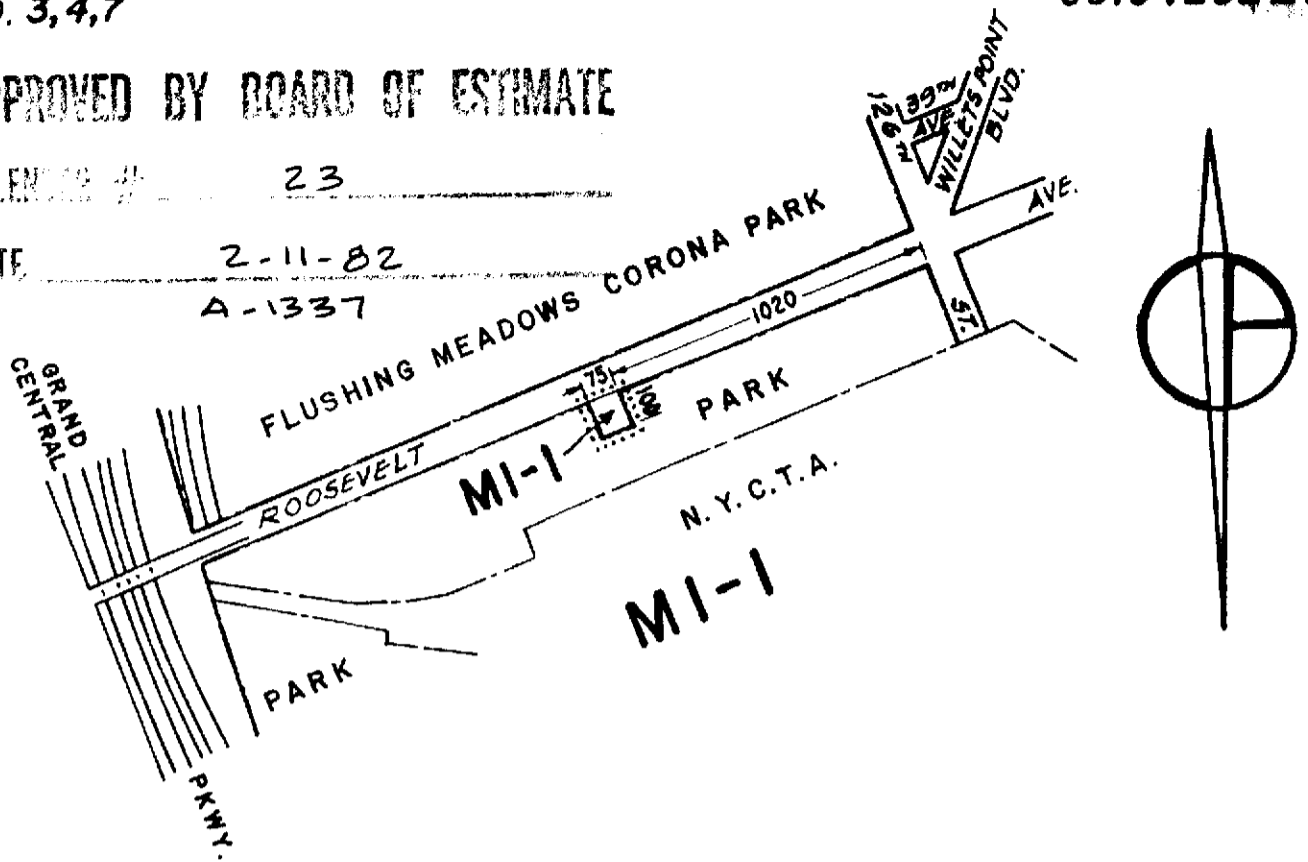

CITY PLANNING COMMISSION  
CITY OF NEW YORK  
**DIAGRAM SHOWING PROPOSED  
ZONING CHANGE  
ON SECTIONAL MAP**

**10b**  
BOROUGH OF  
**QUEENS**

**Certification Date:**  
New York, **September 21, 1981**

*[Signature]* P.E.  
Director, Division of Zoning

AND  
*[Signature]* Chief Engineer

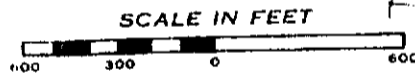

- NOTE:**
- indicates Zoning District boundary.
  - ..... The area enclosed by the fine dotted line is proposed to be changed by establishing an MI-1 District on property formerly mapped as Park.

-H.C.

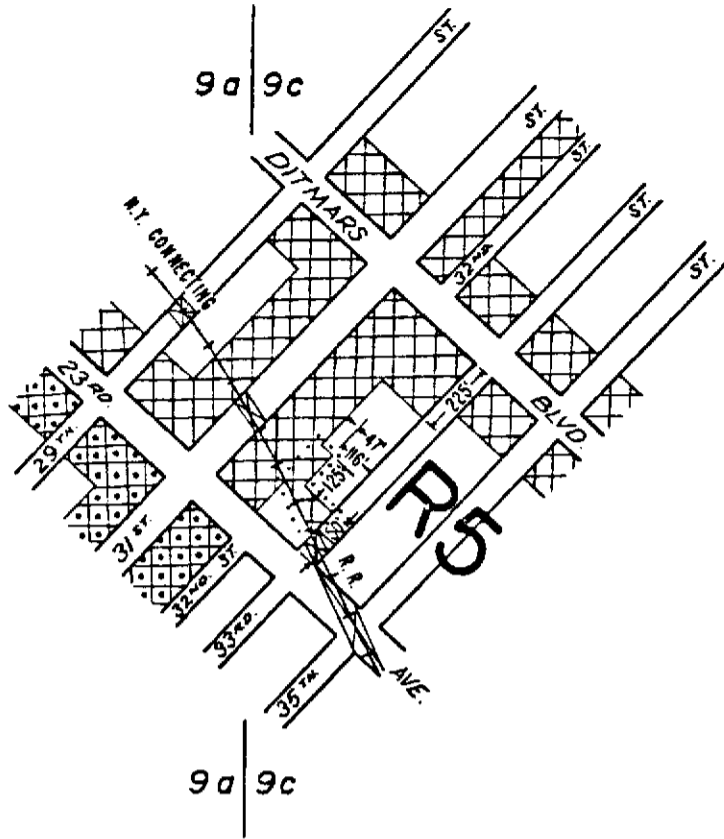
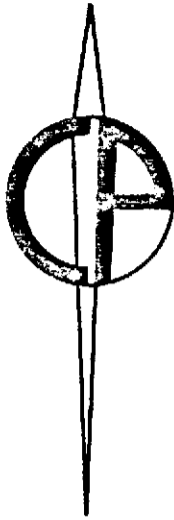

APPROVED BY BOARD OF ESTIMATE

MEMORANDUM NO. 24

DATE 2-11-82

A-1336

CITY PLANNING COMMISSION  
CITY OF NEW YORK  
DIAGRAM SHOWING PROPOSED  
ZONING CHANGE  
ON SECTIONAL MAP  
9c

BOROUGH OF  
QUEENS

Certification Date  
New York, October 5, 1981

*Israel Kwan*, P.E.  
Director of Zoning





AND

Acting Chief, Engineer

SCALE IN FEET



NOTE:

-  indicates Zoning District boundary.
-  The area enclosed by the fine dotted line is proposed to be changed by establishing a C1-2 District within an existing R5 District.
-  indicates a C1-2 District.
-  indicates a C2-2 District.

015

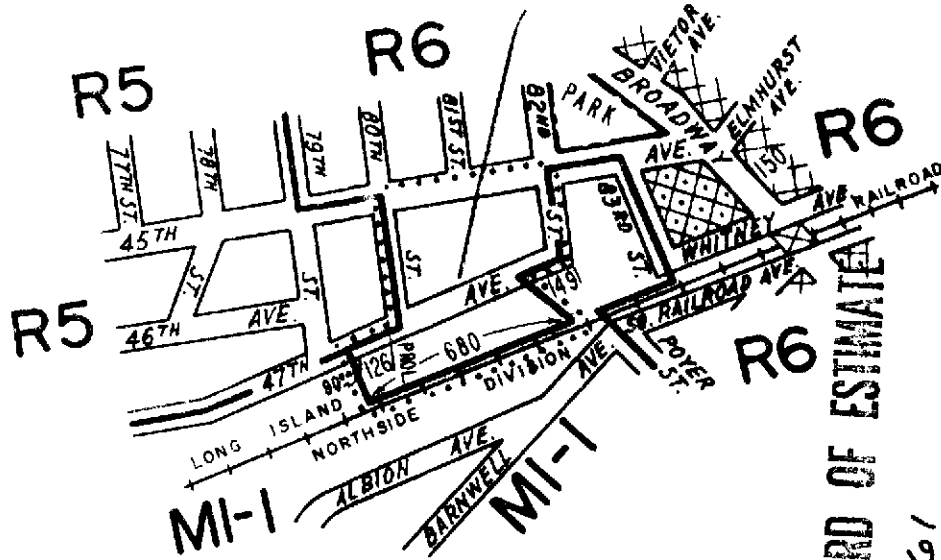
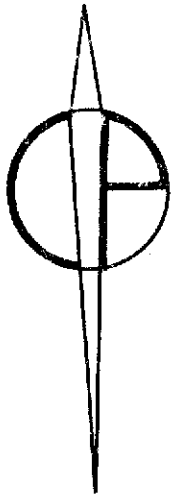

CITY PLANNING COMMISSION  
 CITY OF NEW YORK  
 DIAGRAM SHOWING PROPOSED  
 ZONING CHANGE  
 ON SECTIONAL MAP  
 9d  
 BOROUGH OF  
 QUEENS

APPROVED BY BOARD OF ESTIMATE

CALENDAR # 61

DATE 6-11-82

A-1343

Certification Date:  
New York, February 8, 1982

*Joseph P. ...*  
 Director, Division of Zoning

*William S. ...*  
 Chief Engineer

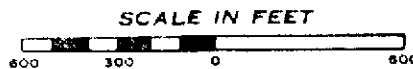

NOTE:

- indicates Zoning District boundary.
- The area enclosed by the fine dotted line is proposed to be changed from an MI-1 District to an R6 District.
- indicates a C1-2 District.
- indicates a C2-2 District.

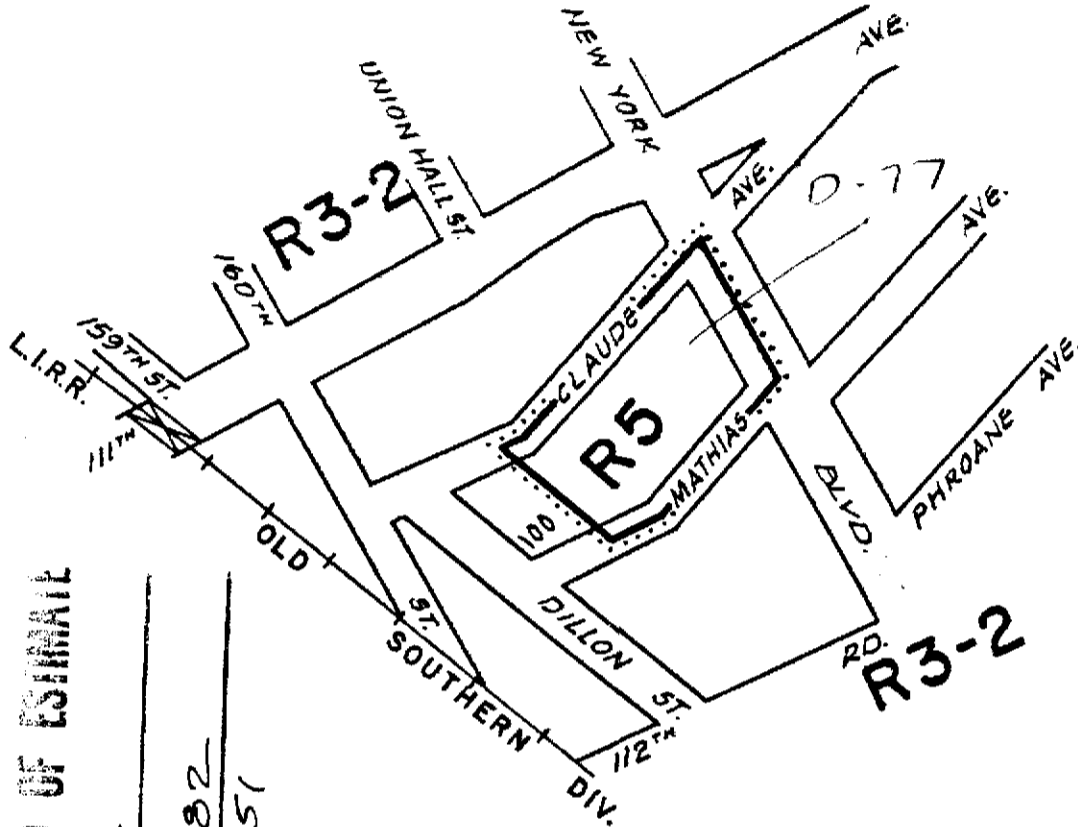

APPROVED BY BOARD OF ESTIMATE

CALENDAR # 52

DATE 8-19-82

A-1351

CITY PLANNING COMMISSION  
 CITY OF NEW YORK  
 DIAGRAM SHOWING PROPOSED  
 ZONING CHANGE  
 ON SECTIONAL MAP

18c

BOROUGH OF QUEENS

Certification Date:  
 New York, June 1, 1982

*Anthony J. Patino, P.E.*  
 Acting Director, Division of Zoning

*JULIUS SPECTOR, P.E.*  
 Chief Engineer  
*per A. Kaen, P.E.*

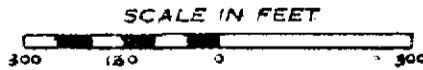

NOTE:

- indicates Zoning District boundary.
- ..... The area enclosed by the fine dotted line is proposed to be changed from an R3-2 District to an R5 District.

A.C.



C.D. 7

CB20965ZMQ

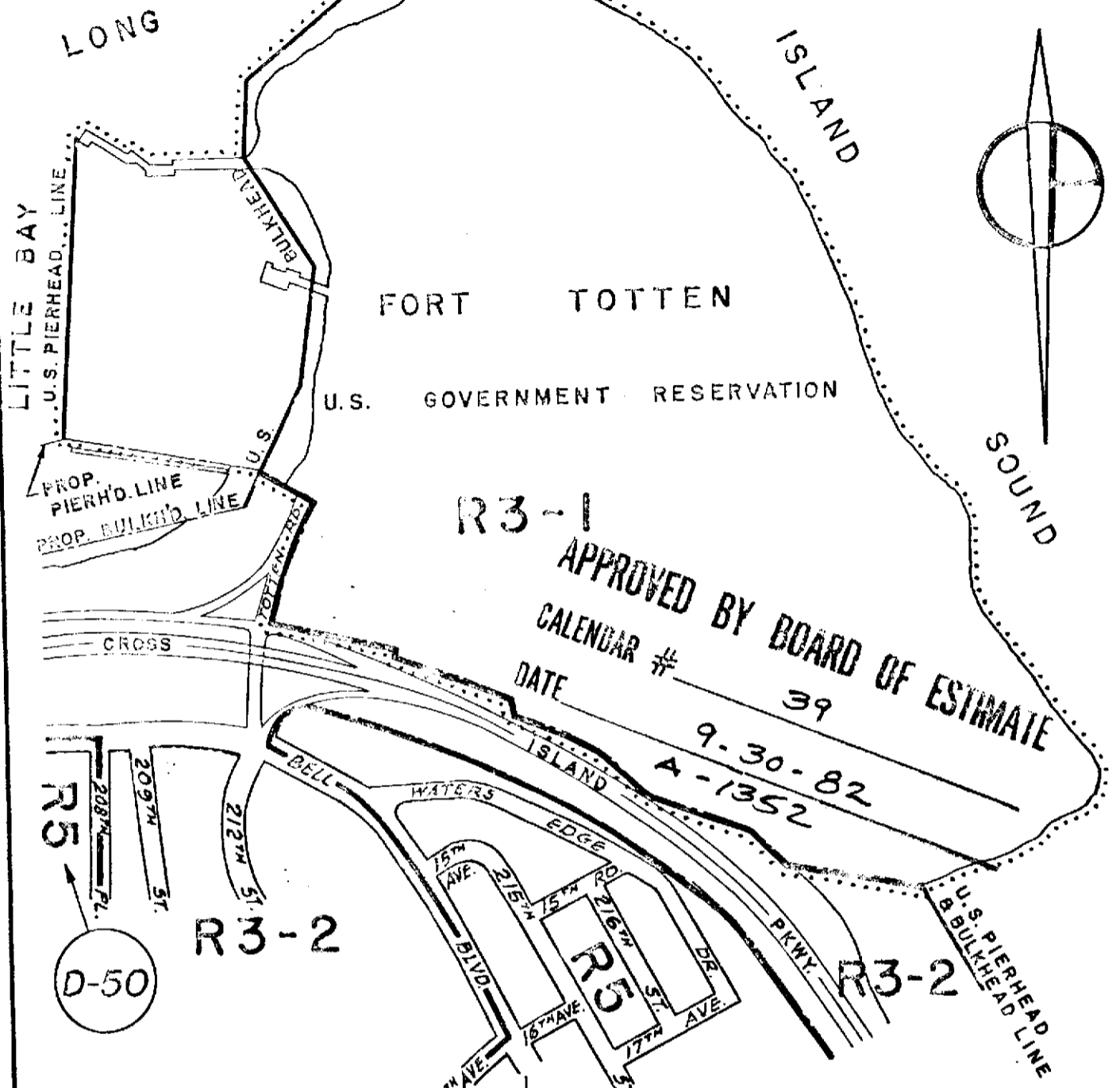

CITY PLANNING COMMISSION  
 CITY OF NEW YORK  
 DIAGRAM SHOWING PROPOSED  
 ZONING CHANGE  
 ON SECTIONAL MAPS

7d & llc  
 BOROUGH OF  
 QUEENS

Certification Date:  
 New York, May 3, 1982

*[Signature]* P.E.  
 Director, Division of Zoning

AND  
*[Signature]*  
 Acting Chief Engineer



- NOTE:
- indicates Zoning District boundary.
  - The area enclosed by the fine dotted line is proposed to be changed from an R3-2 District to an R3-1 District.
  - indicates a Restrictive Declaration Area.

APPROVED BY BOARD OF ESTIMATE

CALENDAR # 28

DATE 10-14-82

A-B54

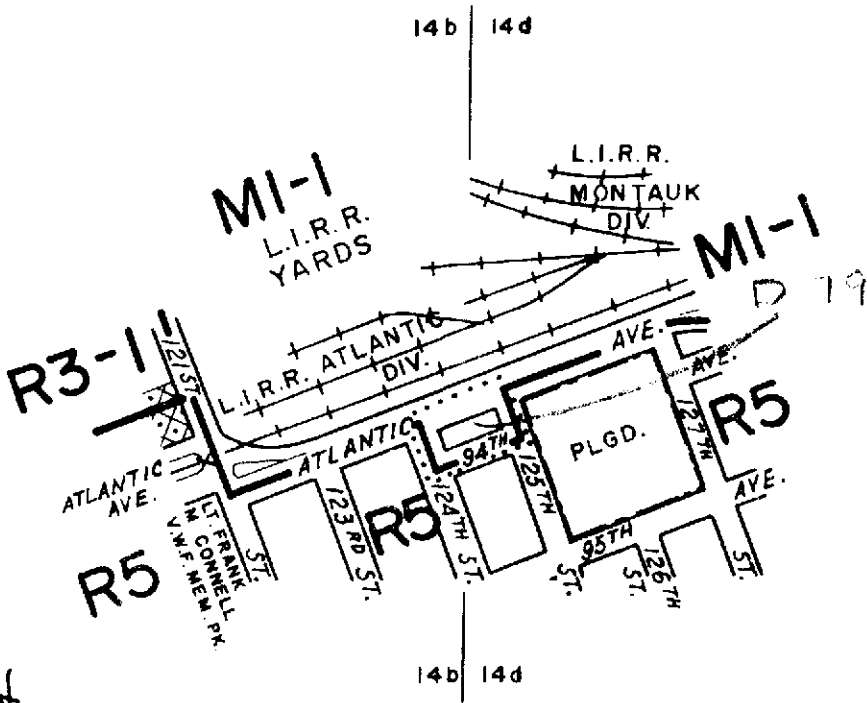

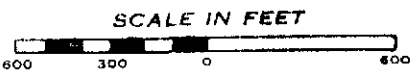

CITY PLANNING COMMISSION  
 CITY OF NEW YORK  
**DIAGRAM SHOWING PROPOSED  
 ZONING CHANGE  
 ON SECTIONAL MAP  
 14b & 14d**  
 BOROUGH OF  
 QUEENS

*[Signature]* RE  
 Director, Division of Zoning  
*[Signature]* RE  
 Chief Engineer



**NOTE:**

-  indicates Zoning District boundary.
-  The area enclosed by the fine dotted line is proposed to be changed from an R5 District to an MI-1 District.
-  indicates a C2-2 District.

APPROVED BY BOARD OF ESTIMATE

CALENDAR # 54

DATE 4.28.83 Δ-1366

C.D. 7

7d|lc

LONG ISLAND SOUND

C821254 ZMQ

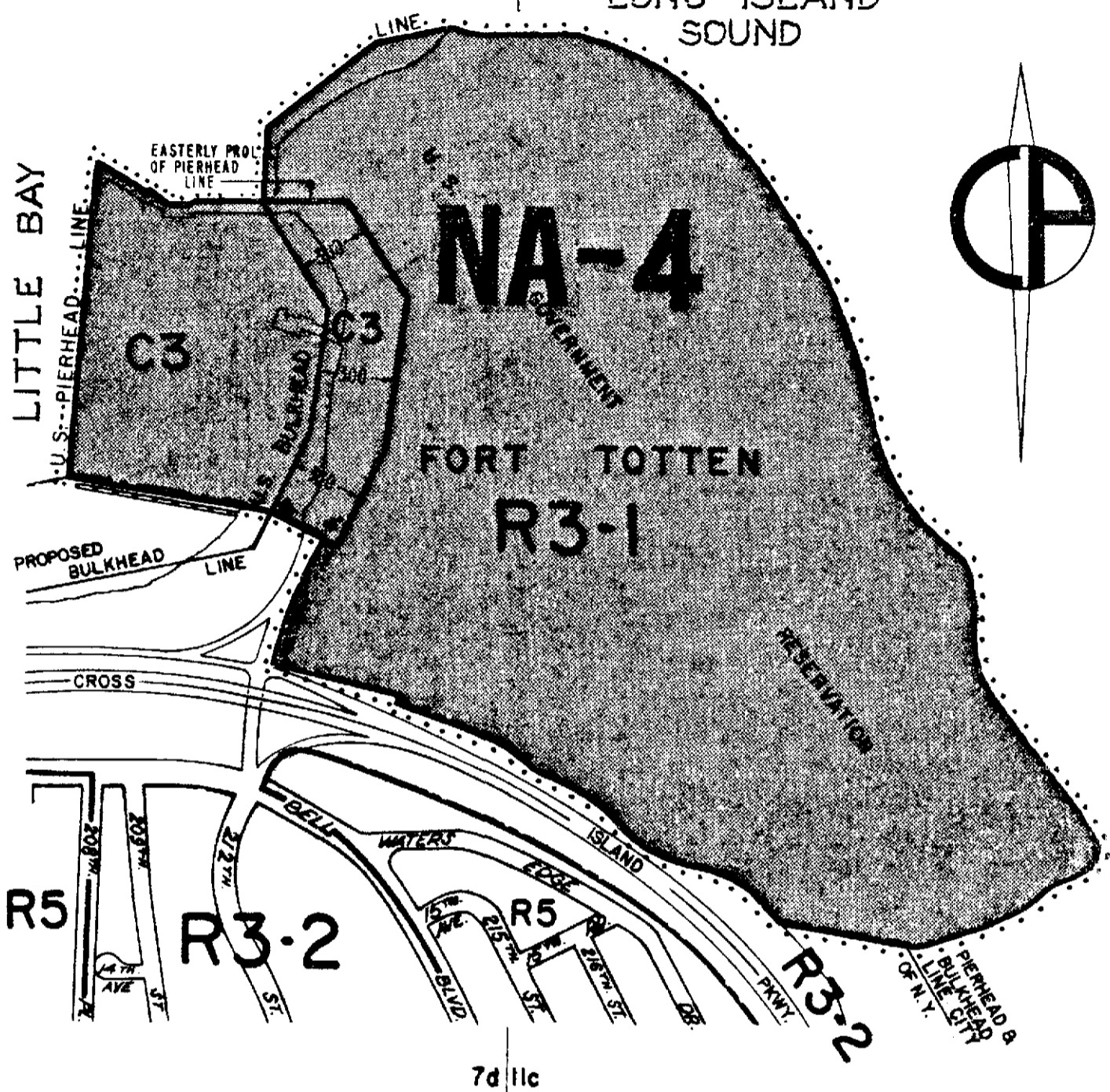

CITY PLANNING COMMISSION  
 CITY OF NEW YORK  
**DIAGRAM SHOWING PROPOSED  
 ZONING CHANGE  
 ON SECTIONAL MAPS  
 7d & llc**

BOROUGH OF QUEENS

Certification Date:  
New York, December 2, 1982

*Julius V. Vago*  
 Director of Technical Review  
*Julius P. Peto* PE  
 Chief Engineer

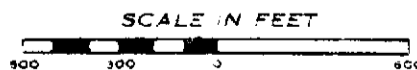

- NOTE:**
- indicates Zoning District boundary.
  - The area enclosed by the fine dotted line is proposed to be changed by establishing a new Special Fort Totten Natural Area District (NA-4), within which an R3-1 District is changed to a C3 District.
  - indicates a Special Fort Totten Natural Area District.

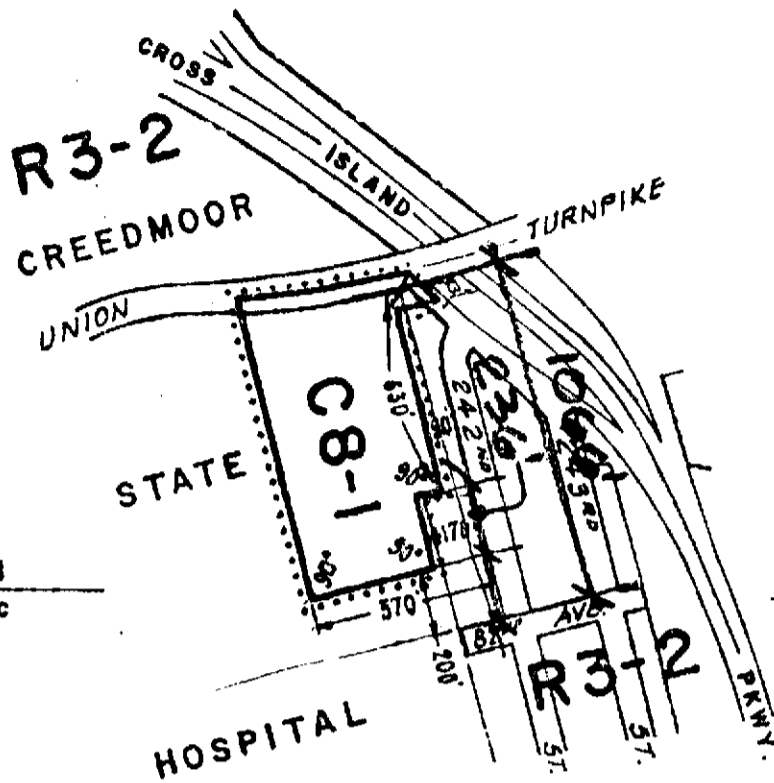

CITY PLANNING COMMISSION  
 CITY OF NEW YORK  
**DIAGRAM SHOWING PROPOSED  
 ZONING CHANGE  
 ON SECTIONAL MAPS  
 11d & 15c**  
 BOROUGH OF  
 QUEENS

Certification Date:  
 New York, November 8, 1982

*Sotirio Vagge*  
 Director of Technical Review

*Julius Raetz P.E.*  
 Chief Engineer

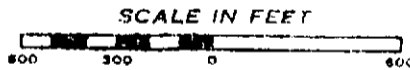

- NOTE:**
- indicates Zoning District boundary.
  - The area enclosed by the fine dotted line is proposed to be changed from an R3-2 District to a C8-1 District.

*McC. Roselle*  
 INFORMATION OBTAINED 7298  
 FROM THESE MAPS 7352  
 Q

APPROVED BY BOARD OF ESTIMATE

CALENDAR # 1

DATE 5-13-83

A-1396

REC. 4-19-84

APPROVED BY BOARD OF ESTIMATE

CALENDAR # 25

DATE 6-16-83

A-1369

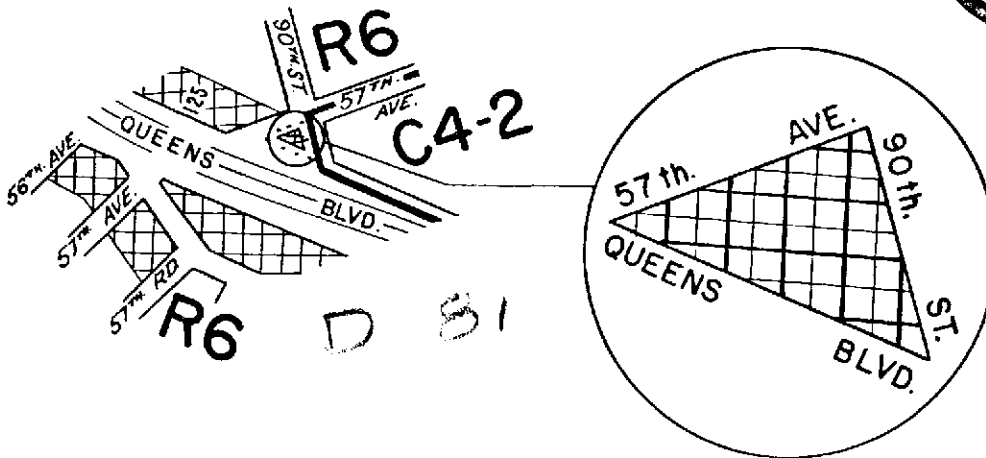

EXAGGERATED SKETCH

CITY PLANNING COMMISSION  
 CITY OF NEW YORK  
**DIAGRAM SHOWING PROPOSED  
 ZONING CHANGE  
 ON SECTIONAL MAP**

13c

BOROUGH OF  
QUEENS





Certification Date  
New York, December 13, 1982

*Sotirio Voyage*  
Director, of Technical Review

*Julius Slects PE*  
Chief, Engineer



NOTE:

-  indicates Zoning District boundary.
-  The area enclosed by the fine dotted line is proposed to be changed by establishing a C1-4 District within an R6 District.
-  indicates a C1-4 District.
-  indicates a C1-2 District.

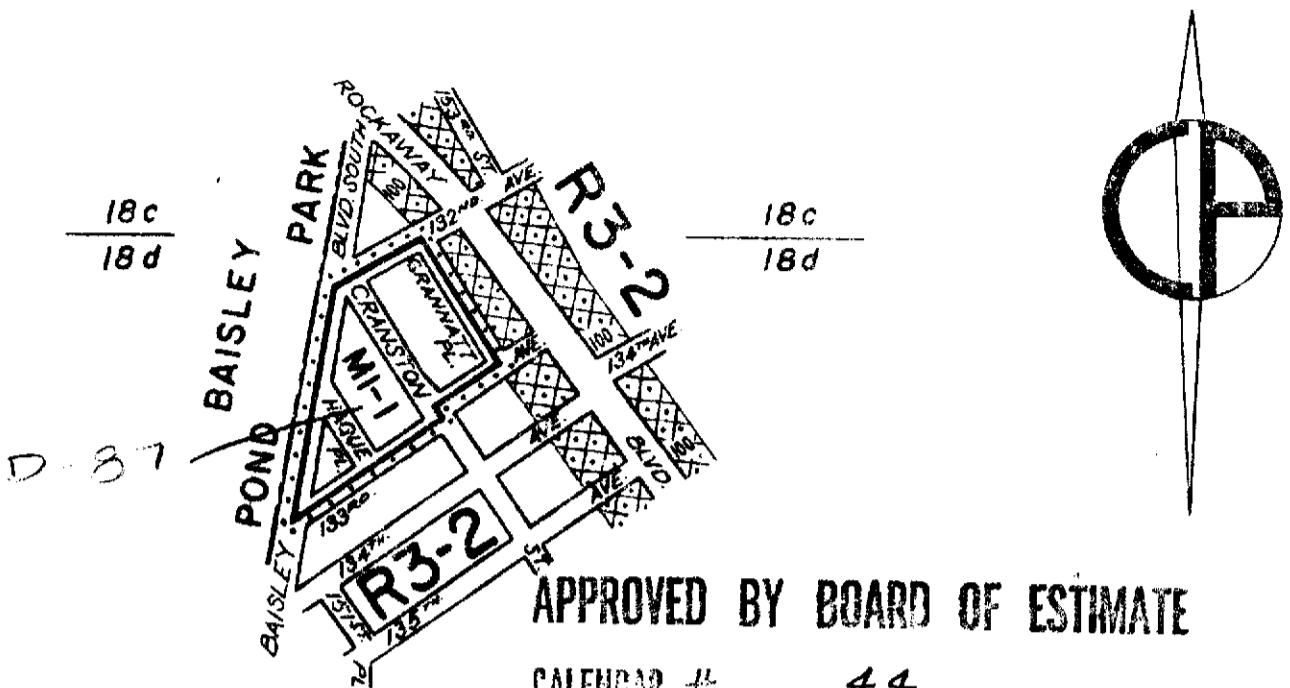

APPROVED BY BOARD OF ESTIMATE

CALENDAR # 44

DATE 6.30-83

A-1370

CITY PLANNING COMMISSION  
 CITY OF NEW YORK  
**DIAGRAM SHOWING PROPOSED  
 ZONING CHANGE  
 ON SECTIONAL MAP  
 18d**

BOROUGH OF  
QUEENS

Certification Date  
New York, January 31, 1983

*Solomon V. Vagstad*  
Director, of Technical Review

*John J. Specter PE*  
Chief, Engineer

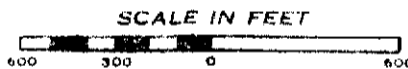

NOTE:

- indicates Zoning District boundary.
- .....** The area enclosed by the fine dotted line is proposed to be changed from an R3-2 District to an MI-1 District.
- ▨** indicates a C2-2 District.

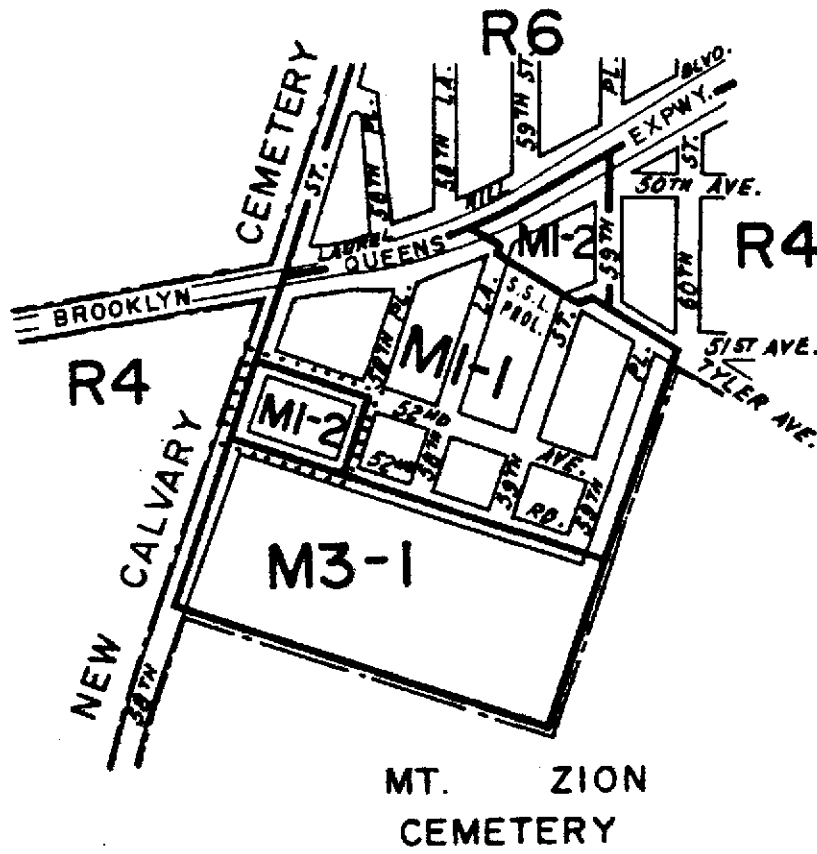

CITY PLANNING COMMISSION  
 CITY OF NEW YORK  
**DIAGRAM SHOWING PROPOSED  
 ZONING CHANGE  
 ON SECTIONAL MAP  
 13c**

BOROUGH OF  
 QUEENS

Certification Date:  
 New York, March 7, 1983

*John V. ...*  
 Director of Technical Review

*Richard J. ...*  
 Asst. Chief Engineer



**NOTE:**  
 ————— indicates Zoning District boundary.  
 ..... The area enclosed by the fine dotted line is proposed to be changed from  
 an MI-1 District to an MI-2 District.

APPROVED BY BOARD OF ESTIMATE

CALENDAR # 58

DATE 8-18-83

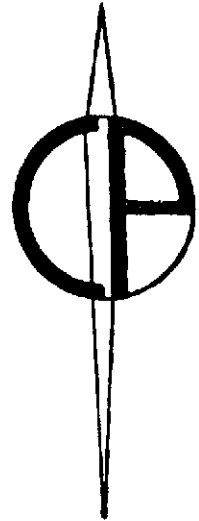
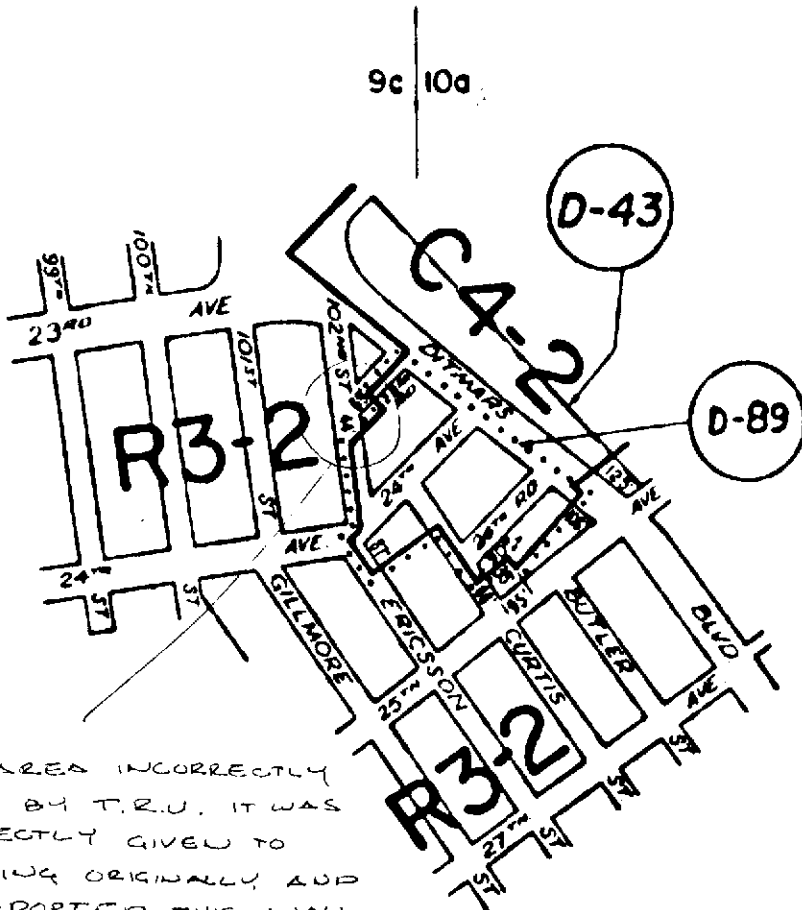

THIS AREA INCORRECTLY SHOWN BY T.R.U. IT WAS INCORRECTLY GIVEN TO DRAFTING ORIGINALLY AND WAS ADOPTED THIS WAY. SEE ATTACHED DRAWING FOR REVISION.

ASP.  
5-A-89

APPROVED BY BOARD OF ESTIMATE

9c 10a CALENDAR # 45  
DATE 11-17-83  
A. 1383

CITY PLANNING COMMISSION  
CITY OF NEW YORK  
DIAGRAM SHOWING PROPOSED  
ZONING CHANGE  
ON SECTIONAL MAPS  
9c & 10a  
BOROUGH OF  
QUEENS

Certification Date  
New York, June 6, 1983

*Wagner*  
Director of Technical Review  
*Julius Specter PE.*  
Chief Engineer

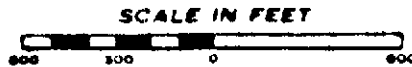

- NOTE:
- indicates Zoning District boundary.
  - ..... The area enclosed by the fine dotted line is proposed to be changed from an R3-2 District to a C4-2 District.
  - (D) indicates a Restrictive Declaration Area.



APPROVED BY BOARD OF ESTIMATE

CALENDAR # 25

DATE 2-9-84

A-1390

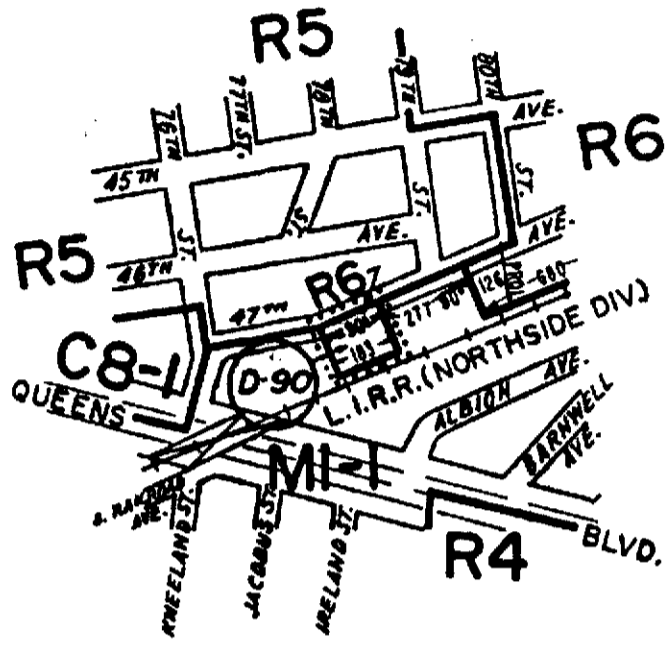

CITY PLANNING COMMISSION  
 CITY OF NEW YORK  
**DIAGRAM SHOWING PROPOSED  
 ZONING CHANGE  
 ON SECTIONAL MAP  
 9d**

BOROUGH OF QUEENS

Certification Date:  
 New York, October 3, 1983  
 Modified: January 18, 1984

*Solimo Voyage*  
 Director of Technical Review  
*Julius D. ...*  
 Chief Engineer

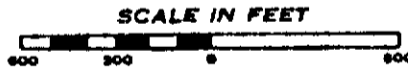

- NOTE:**
- indicates Zoning District boundary.
  - .....** The area enclosed by the fine dotted line is proposed to be changed from an MI-1 District to an R6 District.
  - (D)** indicates a Restrictive Declaration Area.

NR

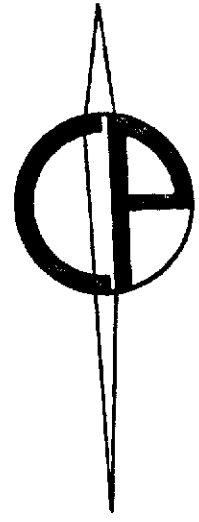
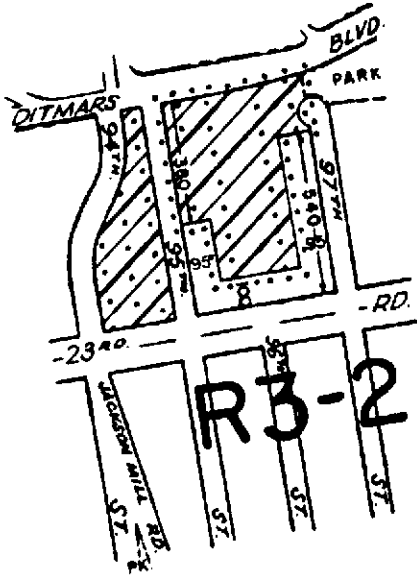

APPROVED BY BOARD OF ESTIMATE

CALENDAR # 20

DATE 3-1-84

A-1393

CITY PLANNING COMMISSION  
 CITY OF NEW YORK  
**DIAGRAM SHOWING PROPOSED  
 ZONING CHANGE  
 ON SECTIONAL MAP**

9c

BOROUGH OF  
QUEENS

Certification Date  
New York, October 11, 1983

*Wojcieszyn*  
Director of Technical Review

*Calvin J. Spector R.E.*  
Chief Engineer



- NOTE:**
- indicates Zoning District boundary.
  - The area enclosed by the fine dotted line is proposed to be changed by establishing a C2-3 District within an existing R3-2 District.
  - indicates a C2-3 District.

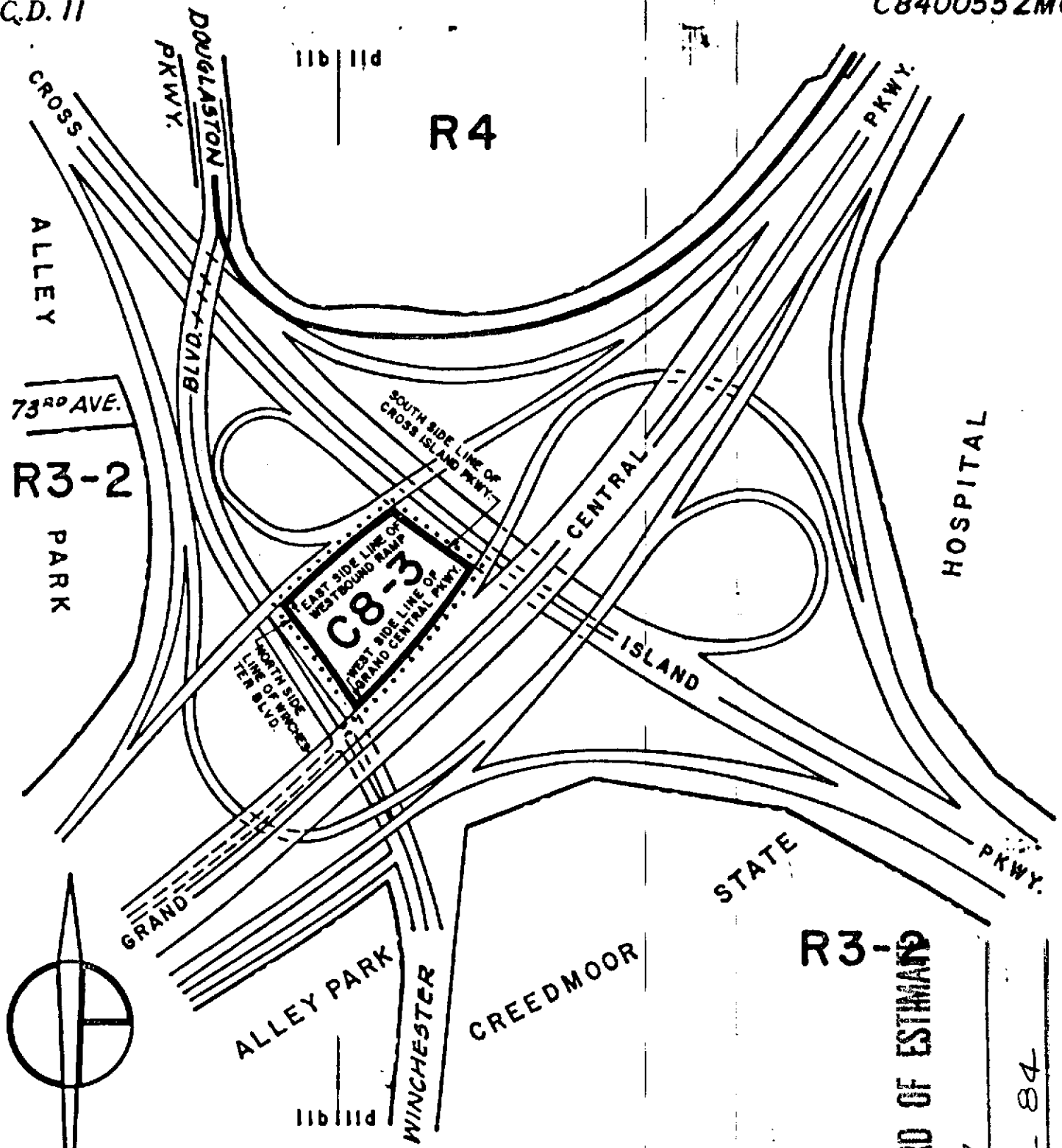

CITY PLANNING COMMISSION  
CITY OF NEW YORK

**DIAGRAM SHOWING PROPOSED  
ZONING CHANGE  
ON SECTIONAL MAP  
11b & 11d  
BOROUGH OF  
QUEENS**

New York, Certification Date  
**March 12, 1984**



**NOTE:**

- indicates Zoning District boundary.
- ..... The area enclosed by the fine dotted line is proposed to be changed from an R3-2 District to a C8-3 District.

**R3-**

**APPROVED BY BOARD OF ESTIMATING**

CALENDAR # 47

DATE 10-4-84

4-1410

*Steven Vozge*  
Director of Technical Review

*Julian Sparto P.E.*  
Chief Engineer

APPROVED BY BOARD OF ESTIMATE

CALENDAR # 45

DATE 12-6-84

A-1414

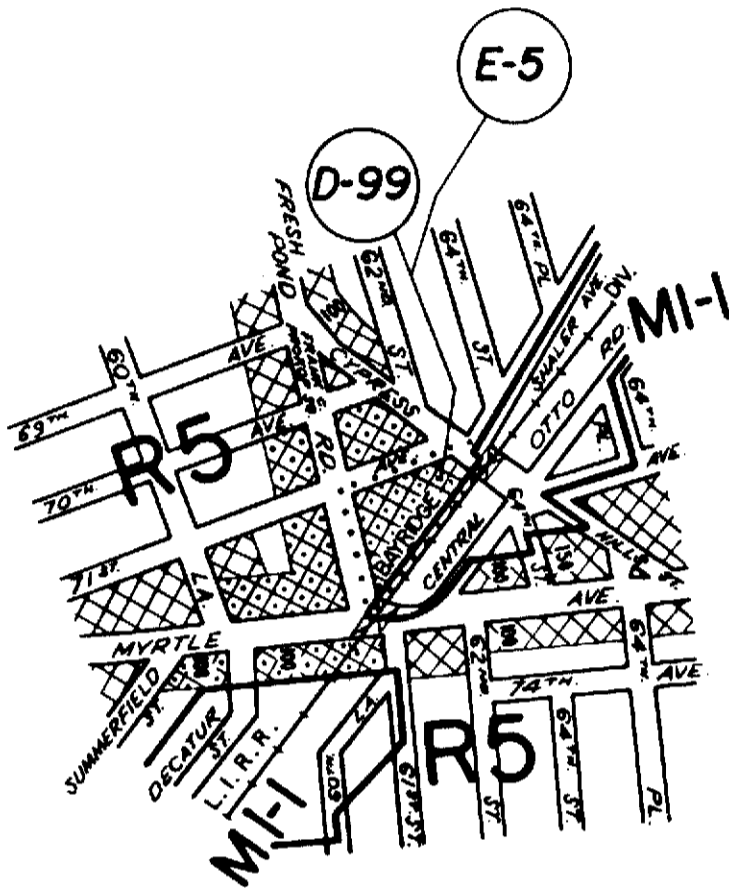
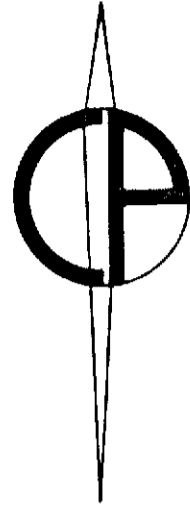

CITY PLANNING COMMISSION  
CITY OF NEW YORK

DIAGRAM SHOWING PROPOSED  
ZONING CHANGE  
ON SECTIONAL MAP  
13 d

BOROUGH OF  
QUEENS

New York, Certification Date  
July 9, 1984

*William Byrnes*  
Director of Technical Review  
*William J. Feltz P.E.*  
Chief Engineer



NOTE:

- indicates Zoning District boundary.
- The area enclosed by the fine dotted line is proposed to be changed from an MI-1 District to an R5 District and establishing a C2-2 District within the proposed R5 District.

- indicates a C2-2 District.
- indicates a C1-2 District.

- indicates a Restrictive Declaration.
- indicates a City Environmental Quality Review Requirements Declaration.

richard companelli

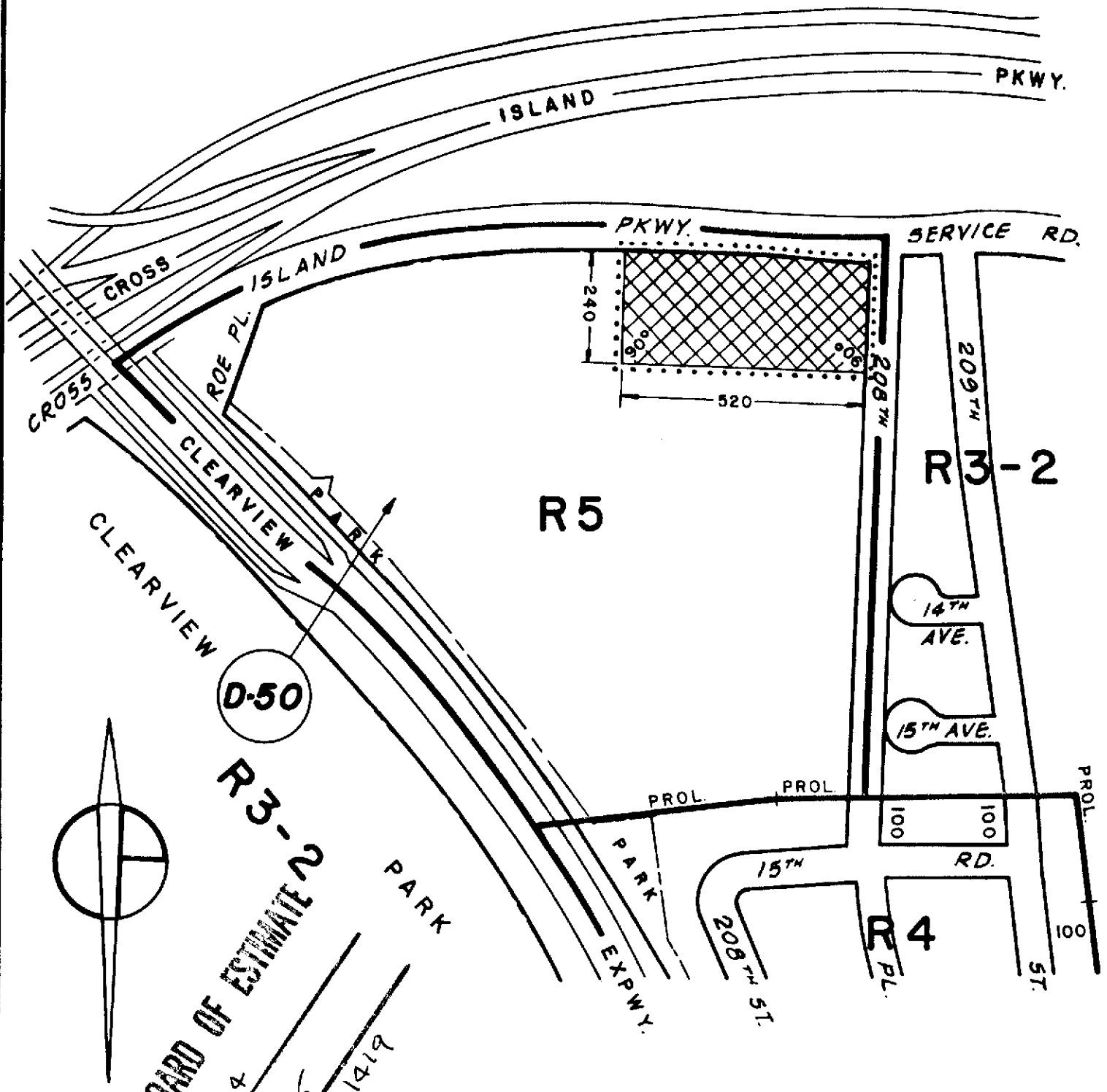

APPROVED BY BOARD OF ESTIMATE 2  
 CALENDAR # 74  
 DATE 1-10-85  
 A-1419

CITY PLANNING COMMISSION  
 CITY OF NEW YORK

**DIAGRAM SHOWING PROPOSED  
 ZONING CHANGE  
 ON SECTIONAL MAP**

**7d**  
 BOROUGH OF  
 QUEENS

New York, Certification Date  
 July 23, 1984

*Gotlieb Voyager*  
 Director of Technical Review  
*Julius Speer PE*  
 Chief Engineer



- NOTE:**
- indicates Zoning District boundary.
  - ..... The area enclosed by the fine dotted line is proposed to be changed by establishing a CI-2 District within an existing R5 District.
  - ▨ indicates a CI-2 District.
  - (D) indicates a Restrictive Declaration.

APPROVED BY BOARD OF ESTIMATE

CALENDAR # 35

DATE 1-24-85

A-1416

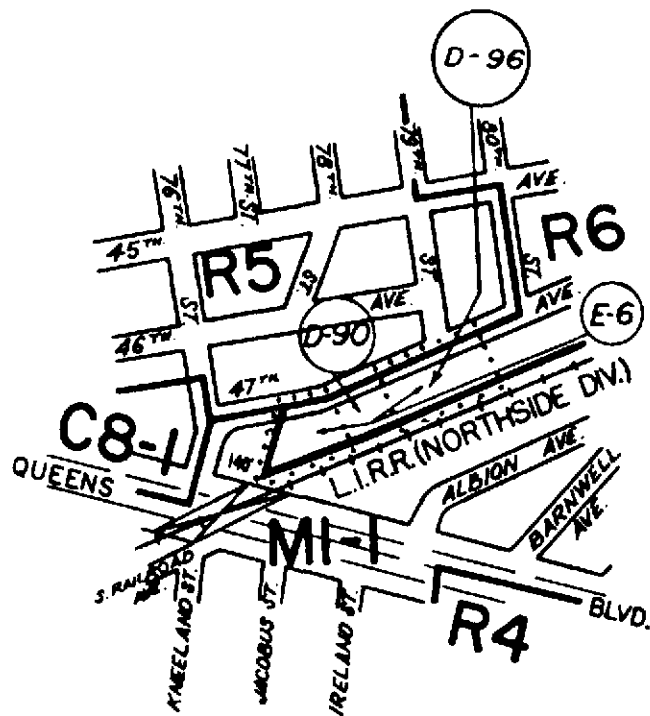
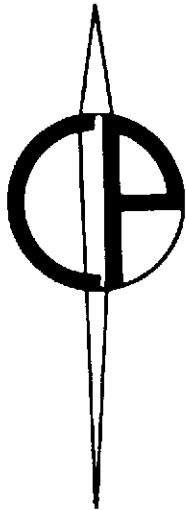

CITY PLANNING COMMISSION  
CITY OF NEW YORK

DIAGRAM SHOWING PROPOSED  
ZONING CHANGE  
ON SECTIONAL MAP

9 d

BOROUGH OF  
QUEENS

New York, Certification Date  
September 17, 1984

*Estimor Vongers*  
Director of Technical Review  
*Julius Specter P.E.*  
Chief Engineer



NOTE:

- indicates Zoning District boundary.
- ..... The area enclosed by the fine dotted line is proposed to be changed from an MI-1 District to an R6 District.
- Ⓚ indicates a Restrictive Declaration Area.
- ⓔ indicates a City Environmental Quality Review Requirements Declaration Area.

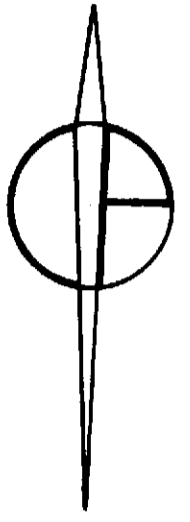
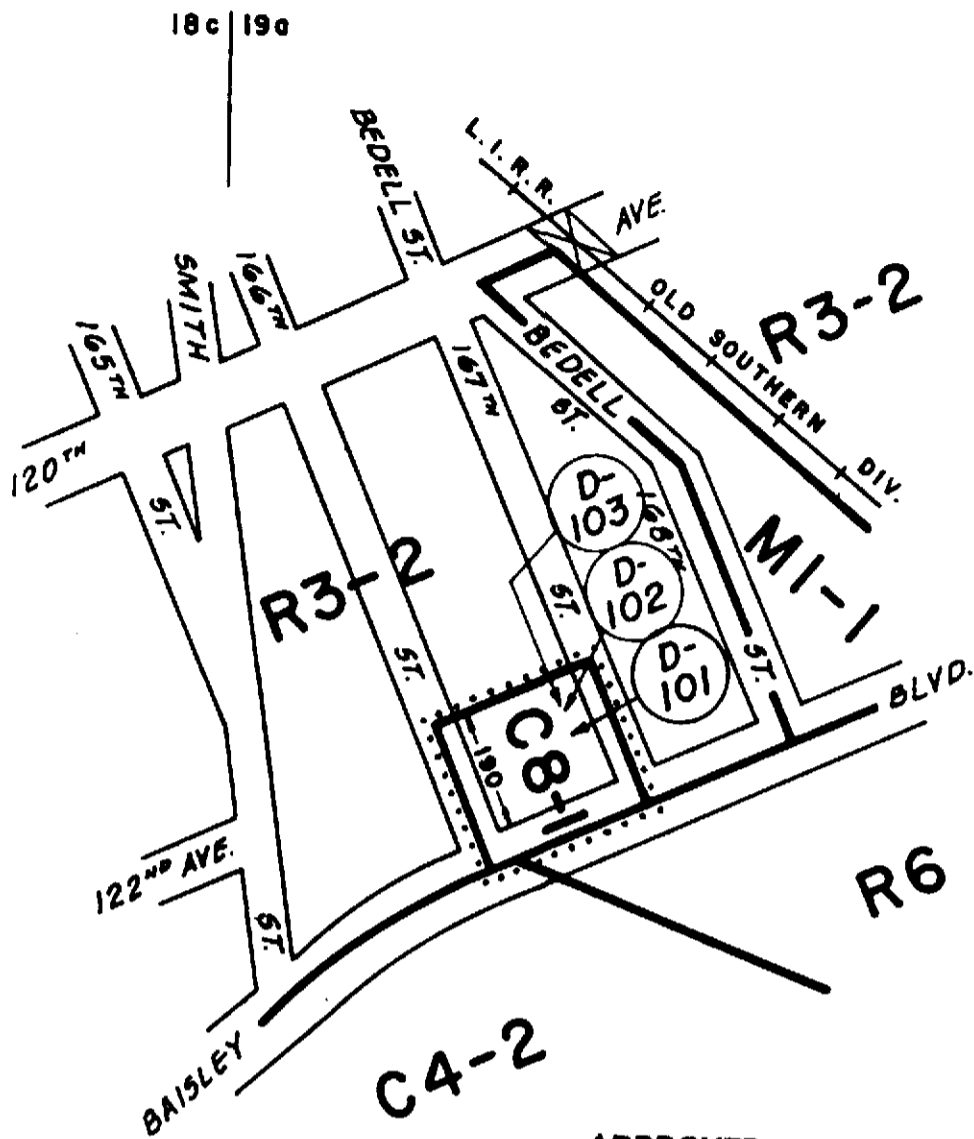

APPROVED BY BOARD OF ESTIMATE  
 CALENDAR # 34  
 DATE 3-28-85  
 A-1417

CITY PLANNING COMMISSION  
 CITY OF NEW YORK

**DIAGRAM SHOWING PROPOSED  
 ZONING CHANGE  
 ON SECTIONAL MAP  
 19a  
 BOROUGH OF  
 QUEENS**

New York, Certification Date  
 November 26, 1984

*Estevan Woyager*  
 Director of Technical Review  
*Julius Spetto P.E.*  
 Chief Engineer



**NOTE:**

- indicates Zoning District boundary.
- .....** The area enclosed by the fine dotted line is proposed to be changed from an R3-2 District to a C8-1 District.
- (D)** indicates a Special Restrictive Declaration.

APPROVED BY BOARD OF ESTIMATE

CALENDAR # 29

DATE 8-14-86

Δ-1449

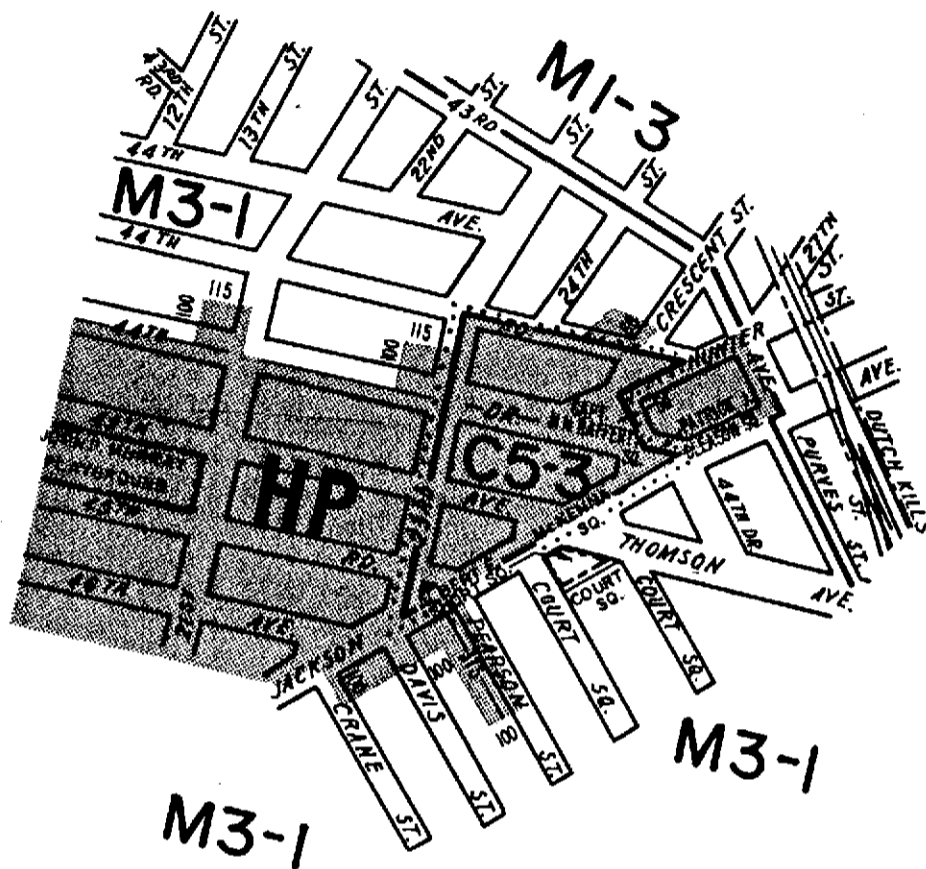

CITY PLANNING COMMISSION  
CITY OF NEW YORK

DIAGRAM SHOWING PROPOSED  
ZONING CHANGE  
ON SECTIONAL MAP  
9b

BOROUGH OF  
QUEENS



New York, Certification Date  
May 14, 1986

*Sotirios Voyago*  
Director of Technical Review

*Julius Spektor P.E.*  
Chief Engineer



**NOTE:**

-  indicates Zoning District boundary.
-  The area enclosed by the fine dotted line is proposed to be changed by extending the Special Hunters Point Mixed Use District and rezoning within the existing and proposed Special Hunters Point Mixed Use District from an M3-1 District to a C5-3 District.
-  indicates a Special Hunters Point Mixed Use - District.



APPROVED BY BOARD OF ESTIMATE

CALENDAR # 47

DATE 9.25-86

A-1454

P A R K

F O R E S T

MARCO J. GIOVANELLI PLAYGROUND

R5

R3-1

M-1

R3-1

R3-1

D-107

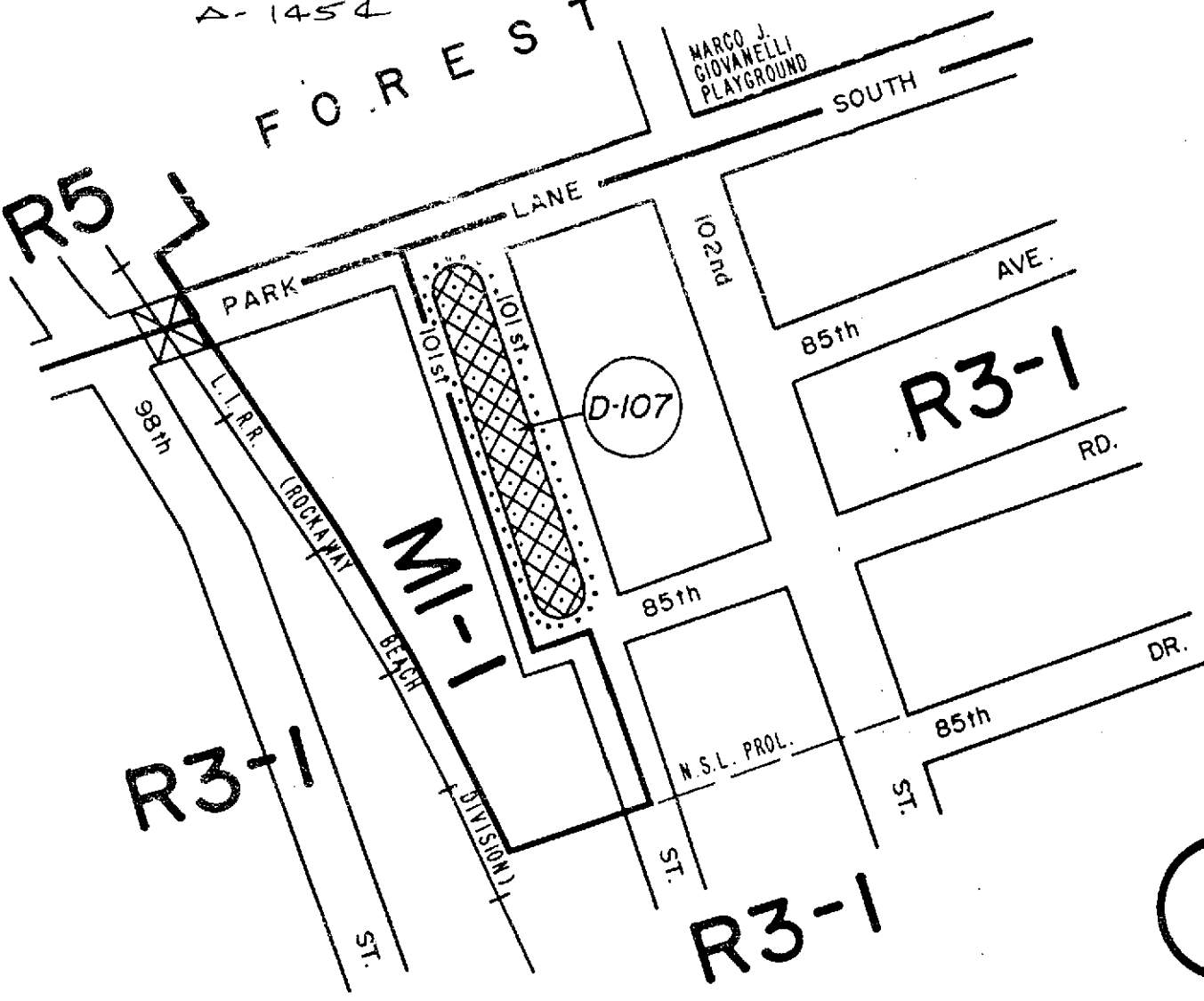

CITY PLANNING COMMISSION  
CITY OF NEW YORK

DIAGRAM SHOWING PROPOSED  
ZONING CHANGE  
ON SECTIONAL MAP  
14b

BOROUGH OF  
QUEENS



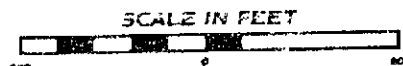

New York, Certification Date  
April 7, 1986

*Solomon Vogel*  
Director of Technical Review

*Julius Specter P.E.*  
Chief Engineer



NOTE:

-  indicates Zoning District boundary.
-  The area enclosed by the fine dotted line is proposed to be changed by establishing a C2-2 District within a proposed R3-1 District.
-  indicates a C2-2 District.
-  indicates a Restrictive Declaration Area.

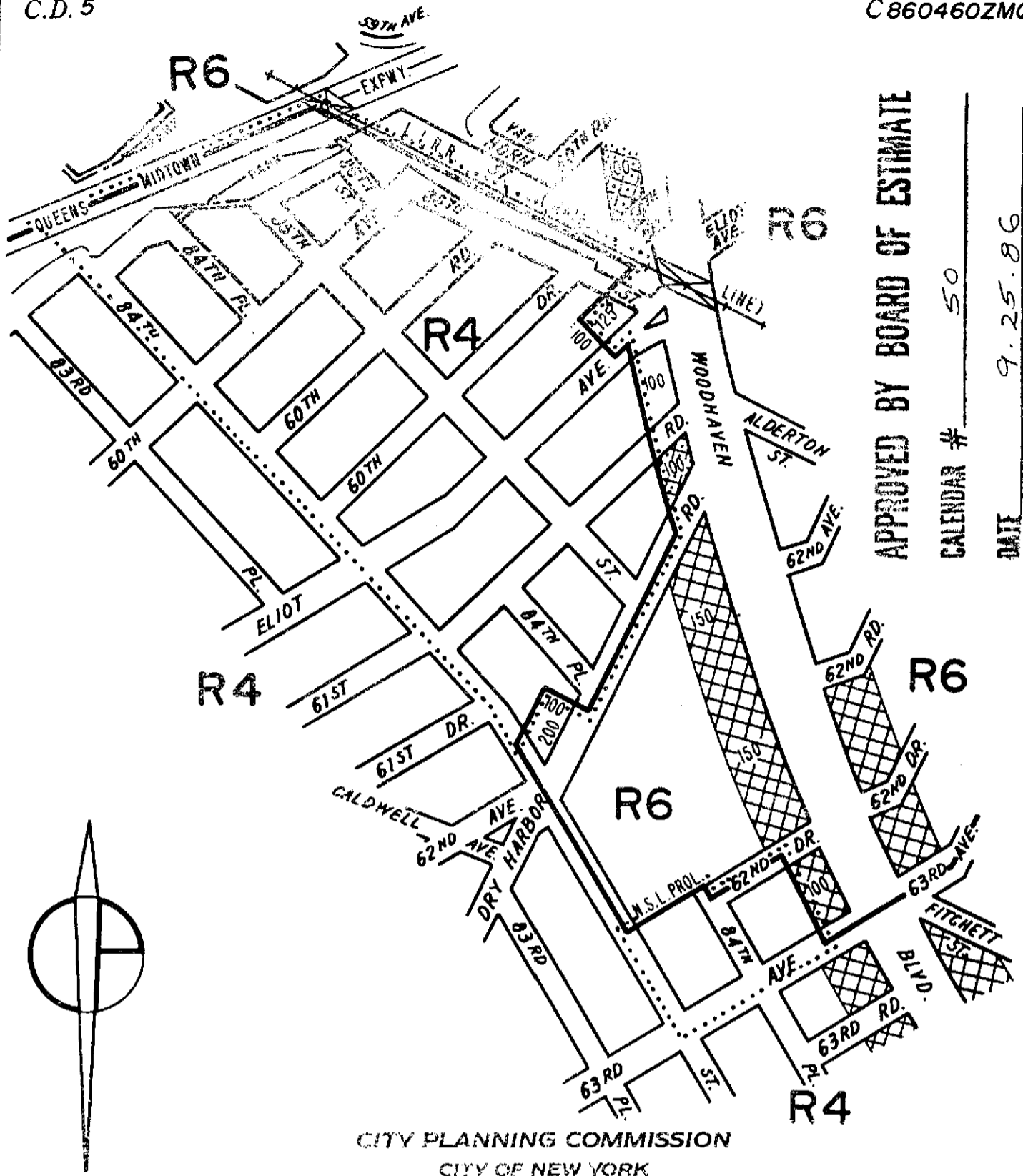

APPROVED BY BOARD OF ESTIMATE

CALENDAR # 50

DATE 9.25.86

A-1455

CITY PLANNING COMMISSION  
CITY OF NEW YORK





DIAGRAM SHOWING PROPOSED  
**ZONING CHANGE**  
 ON SECTIONAL MAP  
**13c**  
 BOROUGH OF  
 QUEENS

New York, Certification Date.  
June 2, 1986

*Stefano Vigneri*  
 Director of Technical Review  
*Julian Specter P.E.*  
 Chief Engineer



**NOTE:**

-  indicates Zoning District boundary.
-  The area enclosed by the fine dotted line is proposed to be changed from an R6 District and CI-2 and C2-2 Districts within an R6 District to an R4 District.
-  indicates a CI-2 District.
-  indicates a C2-2 District.

# ROCKAWAY COMMUNITY PARK

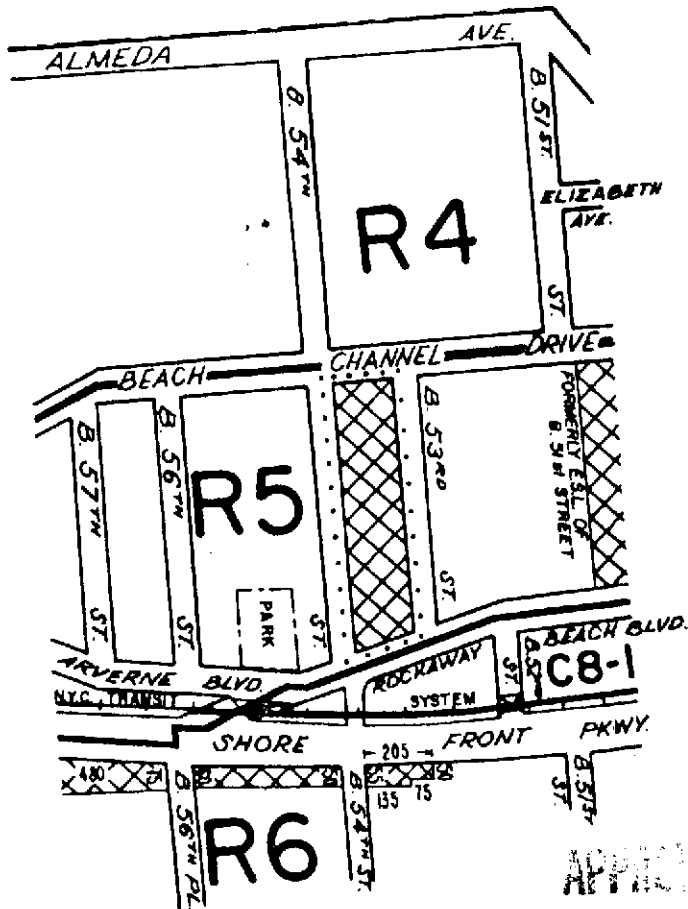

APPROVED BY [Signature] OF [Title]

CREATED BY [Signature] 26

DATE 12-4-86

A-1461

CITY PLANNING COMMISSION  
CITY OF NEW YORK

## DIAGRAM SHOWING PROPOSED ZONING CHANGE ON SECTIONAL MAP 30c

BOROUGH OF QUEENS

New York, Certification Date  
July 21, 1986

[Signature]  
Deputy Director of Technical Review

[Signature]  
Assistant Chief Engineer



**NOTE:**

- indicates Zoning District boundary.
- ..... The area enclosed by the fine dotted line is proposed to be changed by establishing a C1-2 District within an existing R5 District.
- ⊗ indicates a C1-2 District.

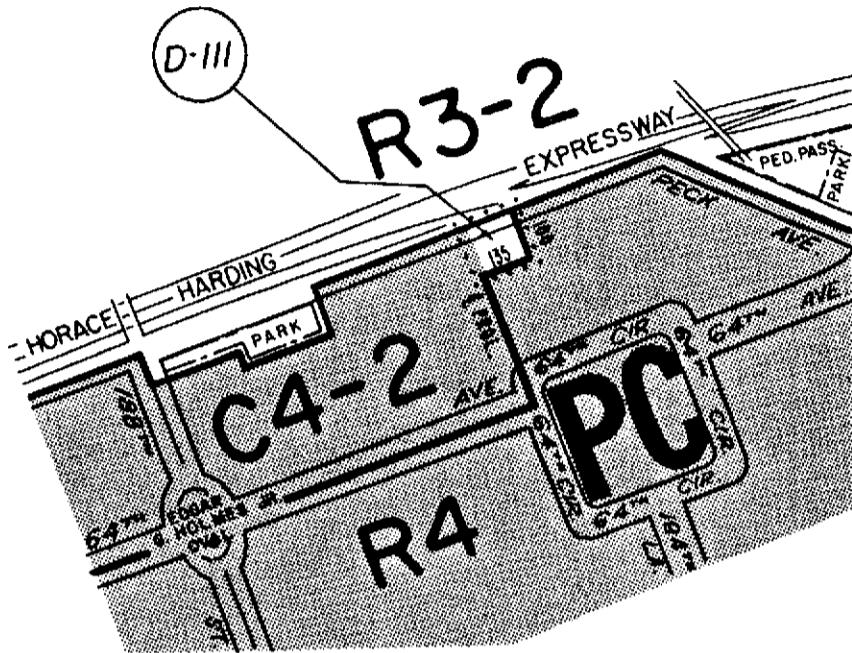
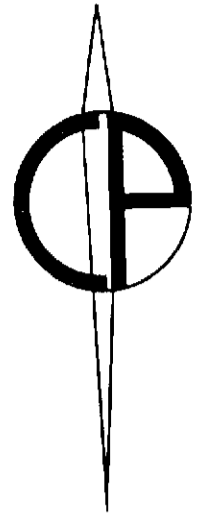

APPROVED BY BOARD OF ESTIMATE

CALENDAR # 32

DATE 12.18.86

A-1462

CITY PLANNING COMMISSION  
CITY OF NEW YORK

DIAGRAM SHOWING PROPOSED  
ZONING CHANGE  
ON SECTIONAL MAP

10d

BOROUGH OF  
QUEENS

New York, Certification Date  
July 21, 1986

*Donald P. Baker*  
Deputy Director of Technical Review

*Joseph J. ...*  
Assistant Chief Engineer

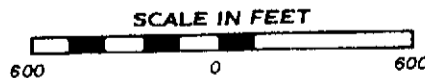

NOTE:

- indicates Zoning District boundary.
- The area enclosed by the fine dotted line is proposed to be changed from an R4 District and a Special Planned Community Preservation District to a C4-2 District.
- indicates a Special Planned Community Preservation District.
- indicates a Restrictive Declaration Area.

11/19/86 11:11 AM

APPROVED BY BOARD OF ESTIMATE

CALENDAR # 20

DATE 4-30-87

Δ - 1467

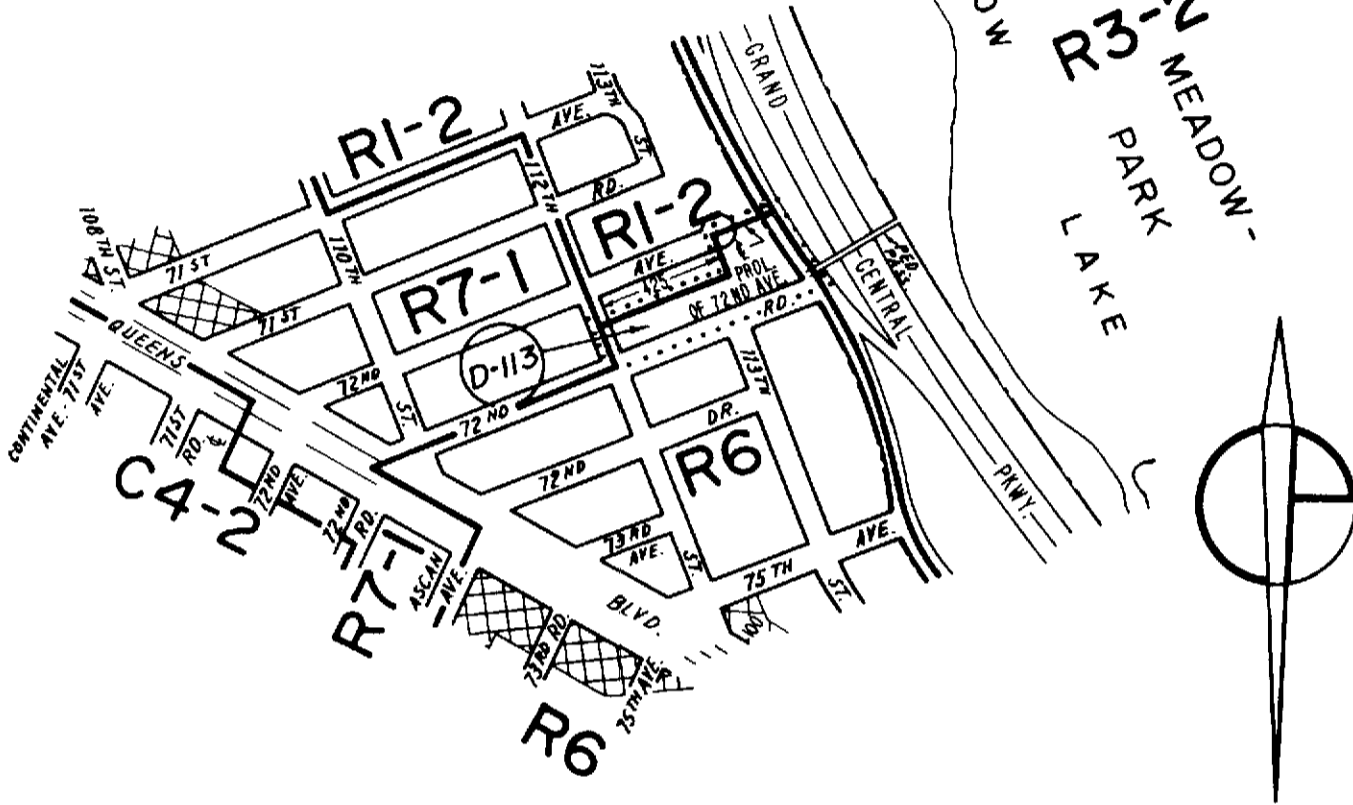

CITY PLANNING COMMISSION  
CITY OF NEW YORK

DIAGRAM SHOWING PROPOSED  
ZONING CHANGE  
ON SECTIONAL MAP

14a

BOROUGH OF  
QUEENS

New York, Certification Date  
November 10, 1986

Director of Technical Review

Chief Engineer

SCALE IN FEET



NOTE:

- indicates Zoning District boundary.
- The area enclosed by the fine dotted line is proposed to be changed from an RI-2 District to an R6 District.
- indicates a CI-2 District.
- indicates a Restrictive Declaration Area.

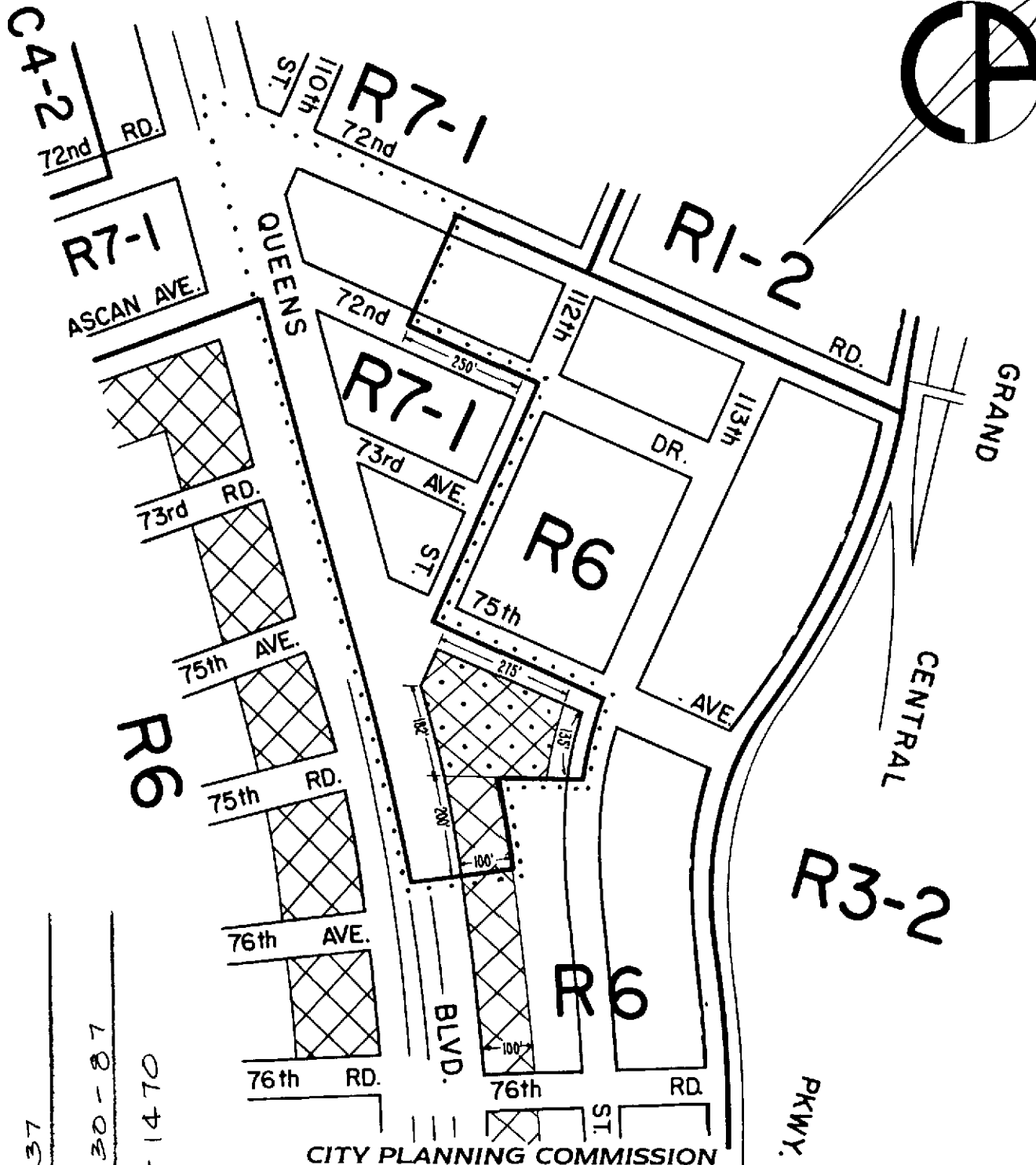
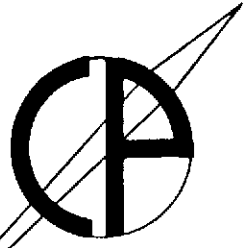

CITY PLANNING COMMISSION  
CITY OF NEW YORK

**DIAGRAM SHOWING PROPOSED  
ZONING CHANGE  
ON SECTIONAL MAP**

14a

BOROUGH OF  
QUEENS

APPROVED BY BOARD OF ESTIMATE

CALENDAR # 37

DATE 6-30-87

A-1470

New York, Certification Date  
**January 28, 1987**  
Revised: April 20, 1987

*Harold Abner*  
Deputy Director of Land Use  
Review Division for Technical  
Review and Planning

*Joseph J. ...* PE  
Acting Chief Engineer



**NOTE:**

- indicates Zoning District boundary.
- The area enclosed by the fine dotted line is proposed to be changed from an R6 and R1-2 Districts to R7-1 and C2-2 Districts.
- indicates a C1-2 District.
- indicates a C2-2 District.

richard campanelli

BR

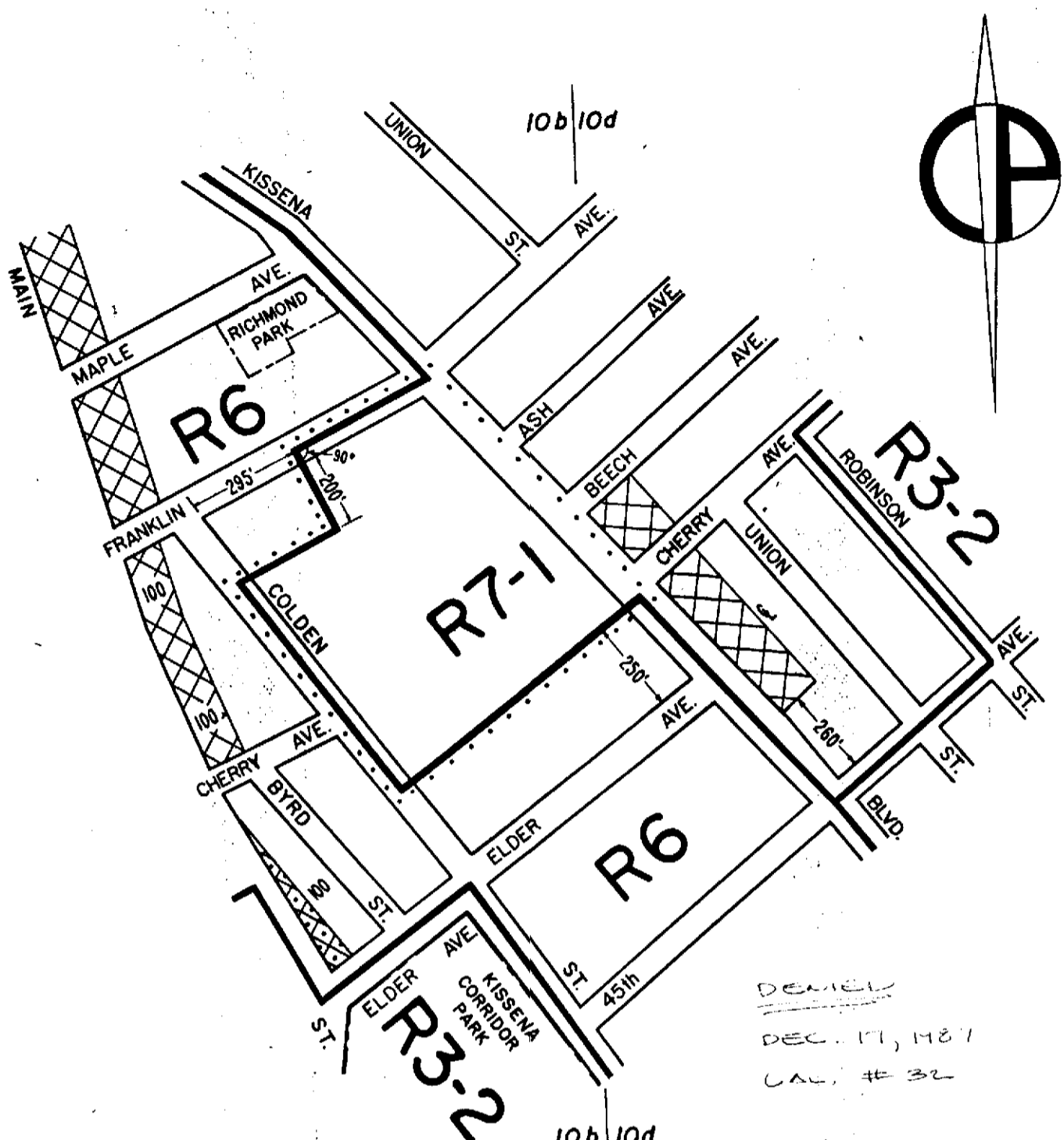

DEVELOP  
 DEC. 17, 1987  
 CAL. # 32

CITY PLANNING COMMISSION  
 CITY OF NEW YORK

**DIAGRAM SHOWING PROPOSED  
 ZONING CHANGE  
 ON SECTIONAL MAPS**



**10b & 10d  
 BOROUGH OF  
 QUEENS**

New York, Certification Date  
 July 20, 1987

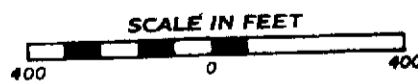
*Anthony J. Patrucco*  
 Deputy Director for  
 Technical Review,  
 Land Use Review Division  
*Anthony J. Patrucco, P.E.*  
 Chief Engineer



**NOTE:**

- indicates Zoning District boundary.
- .....** The area enclosed by the fine dotted line is proposed to be changed from an R6 District to an R7-1 District.
-  indicates a C1-2 District.
-  indicates a C2-2 District.

richard campanelli

APPROVED BY BOARD OF ESTIMATE

CALENDAR # 2

DATE 3-2-87

A- 1464

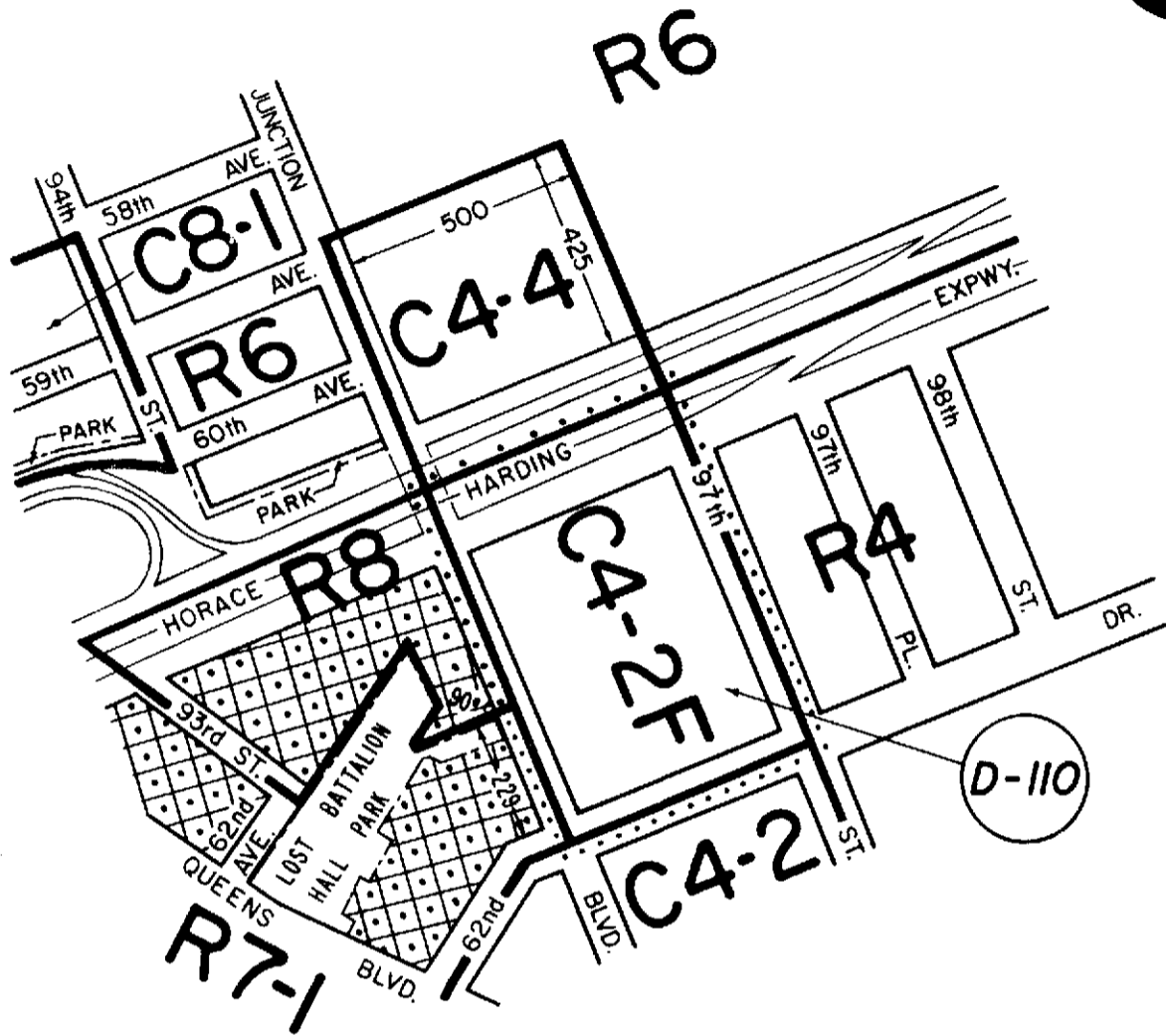
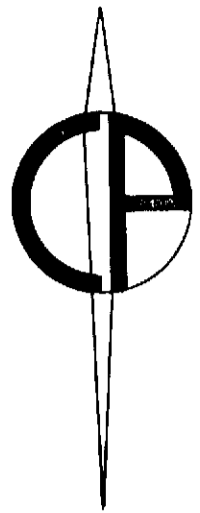

CITY PLANNING COMMISSION  
CITY OF NEW YORK

DIAGRAM SHOWING PROPOSED  
ZONING CHANGE  
ON SECTIONAL MAP  
14a

BOROUGH OF  
QUEENS

New York, Certification Date  
August 25, 1986

*Soteria Voyager*  
Director of Technical Review

*Julius Speck P.E.*  
Chief Engineer

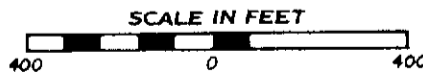

NOTE:

- indicates Zoning District boundary.
- The area enclosed by the fine dotted line is proposed to be changed from R8 and C4-2A Districts to a C4-2F District.
- indicates a C2-2 District.
- indicates a Restrictive Declaration.

CITY OF NEW YORK



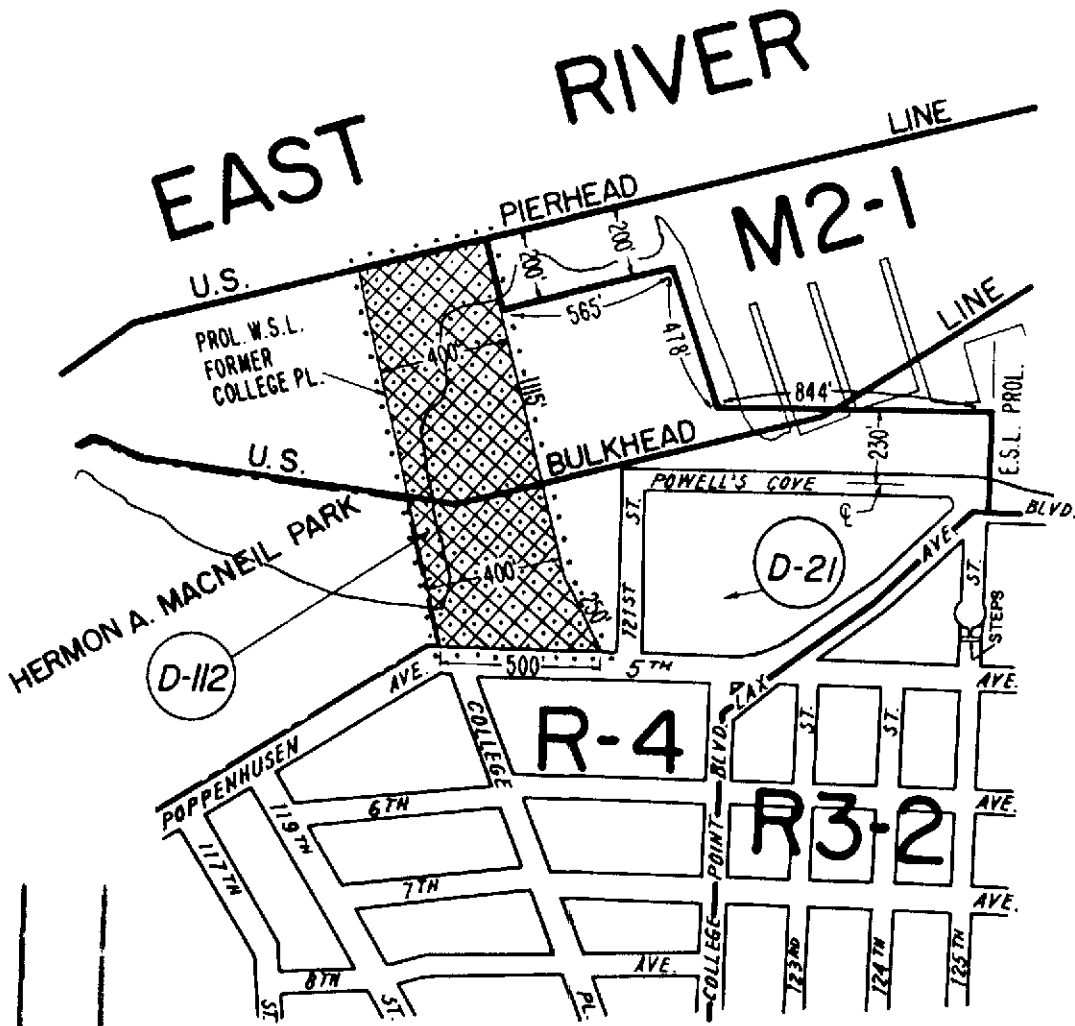

APPROVED BY BOARD OF ESTIMATE

CALENDAR # 14

DATE 3-26-87

A-1466

CITY PLANNING COMMISSION  
CITY OF NEW YORK

DIAGRAM SHOWING PROPOSED  
ZONING CHANGE  
ON SECTIONAL MAP

7b

BOROUGH OF  
QUEENS

New York, Certification Date  
October 6, 1986

*Steven V. ...*  
 Director of Technical Review  
*David ...* P.E.  
 Acting Chief Engineer



NOTE:

- indicates Zoning District boundary.
- The area enclosed by the fine dotted line is proposed to be changed from an M2-1 District to an R4 District and by establishing a C2-2 District within the proposed and existing R4 District.
- indicates a C2-2 District.
- indicate a Restrictive Declaration.

APPROVED BY BOARD OF ESTIMATE

CALENDAR # 57

DATE 8-13-87

A-1472

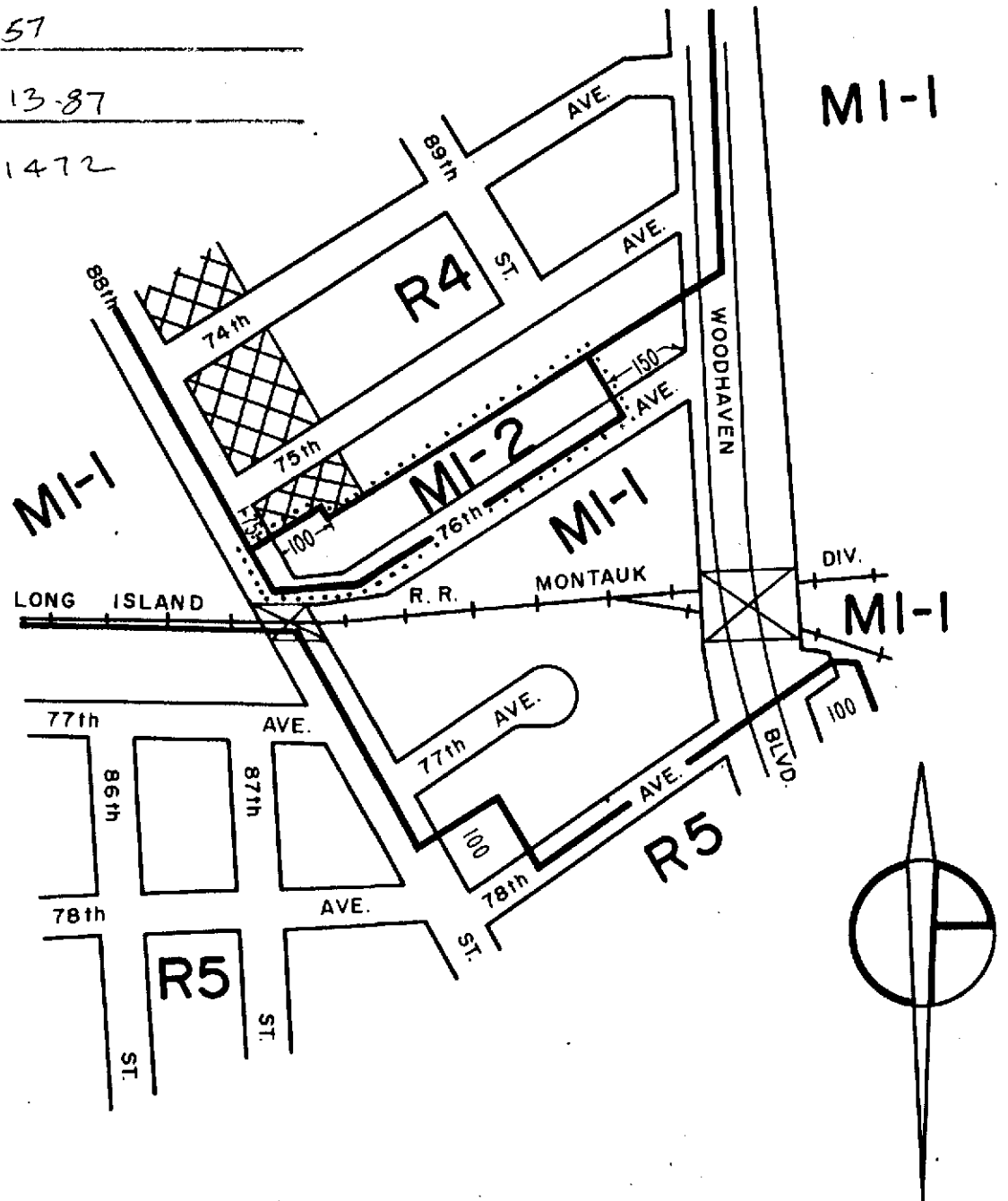

CITY PLANNING COMMISSION  
CITY OF NEW YORK

DIAGRAM SHOWING PROPOSED  
ZONING CHANGE  
ON SECTIONAL MAP

14b  
BOROUGH OF  
QUEENS

New York, Certification Date  
March 16, 1987  
Modified by B.O.E.  
August 13, 1987

*[Signature]*  
Deputy Director of Land Use  
Review Division for Technical  
Review

*[Signature]*, P.E.  
Acting Chief Engineer



NOTE:

- indicates Zoning District boundary.
- .....** The area enclosed by the fine dotted line is proposed to be changed from MI-1 and CI-2 Districts to an MI-2 District.
- XXXXXX** indicates a CI-2 District.

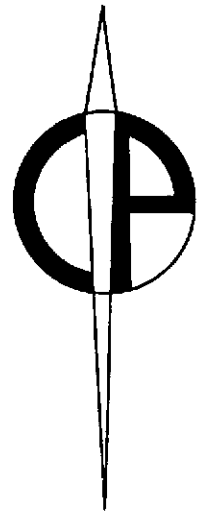
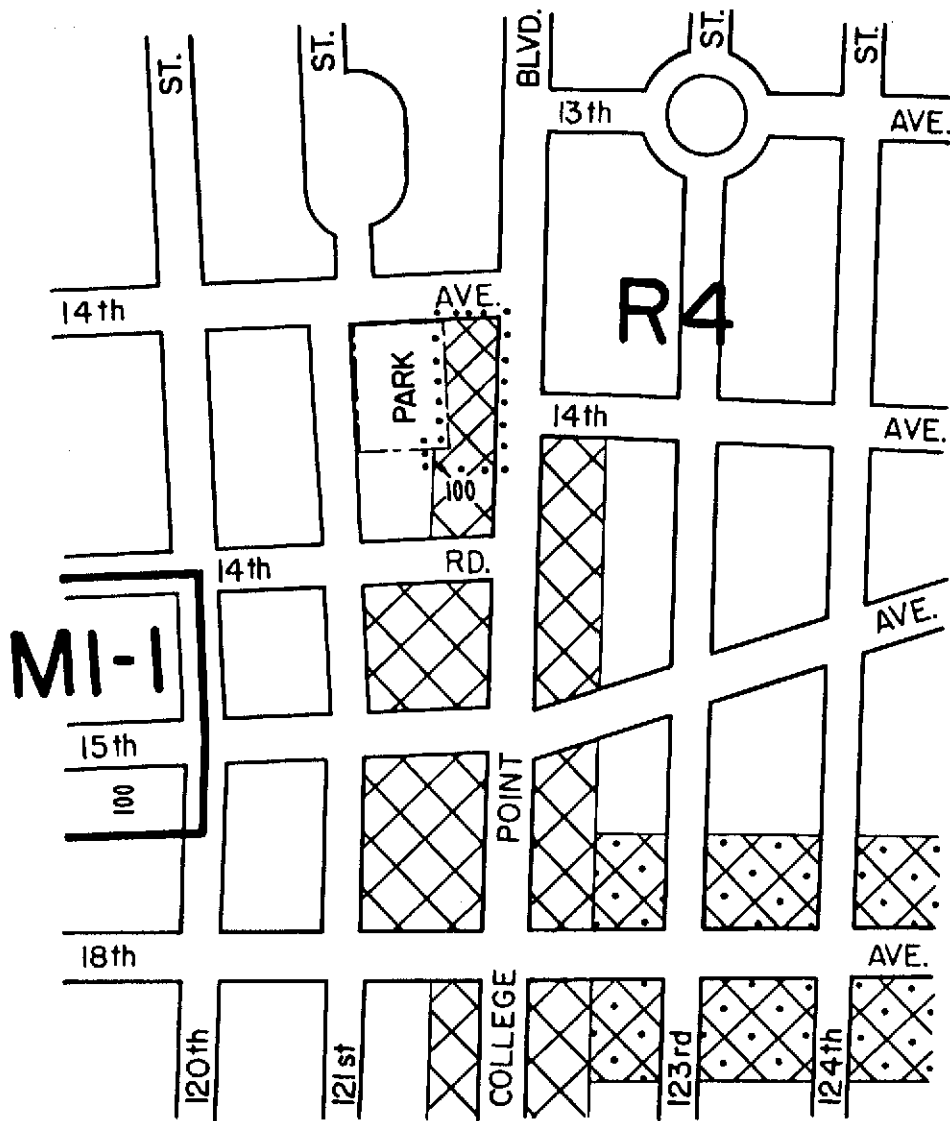

APPROVED BY BOARD OF ESTIMATE

CALENDAR # 39

DATE 10-1-87

A-1480

CITY PLANNING COMMISSION  
CITY OF NEW YORK

DIAGRAM SHOWING PROPOSED  
ZONING CHANGE  
ON SECTIONAL MAP

7b

BOROUGH OF  
QUEENS

New York, Certification Date  
May 18, 1987

*[Signature]*  
Deputy Director for Technical Review,  
Land Use Review Division  
*[Signature]* P.E.  
Acting  
Chief Engineer



NOTE:

- indicates Zoning District boundary.
- The area enclosed by the fine dotted line is proposed to be changed by establishing a CI-2 District within an R4 District.
- indicates a CI-2 District.
- indicates a C2-2 District.

richard campanelli

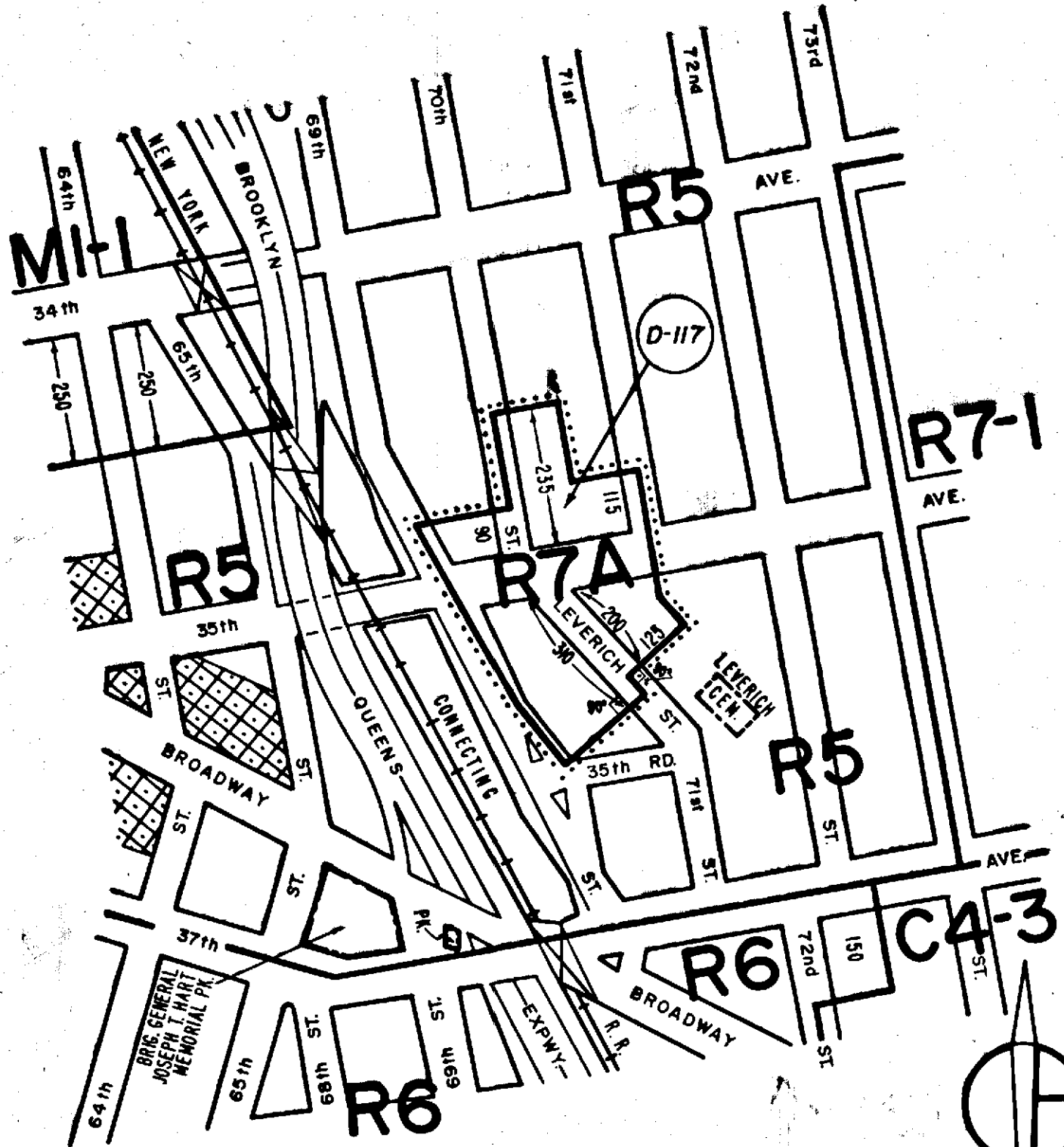

CITY PLANNING COMMISSION  
CITY OF NEW YORK

**DIAGRAM SHOWING PROPOSED  
ZONING CHANGE  
ON SECTIONAL MAP**

**9d  
BOROUGH OF  
QUEENS**



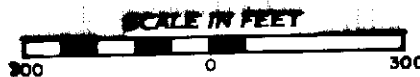

New York, Certification Date  
**June 15, 1987**

*Don Bon*  
Deputy Director for Technical Review,  
Land Use Review Division

*Anthony J. Patino, P.E.*  
Chief Engineer



**NOTE:**

-  Indicates Zoning District boundary.
-  The area enclosed by the fine dotted line is proposed to be changed from an R5 District to an R7A District.
-  Indicates a C2-2 District.
-  Indicates a Restrictive Declaration Area, refer to R.D. sheet.

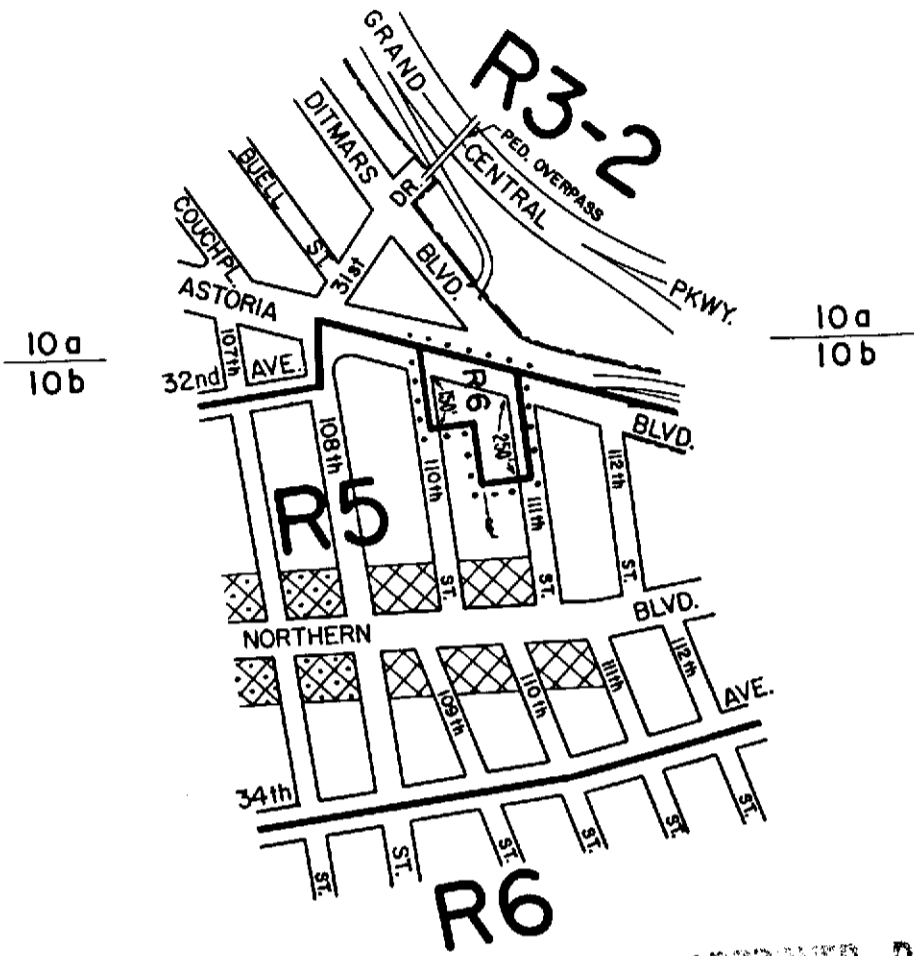
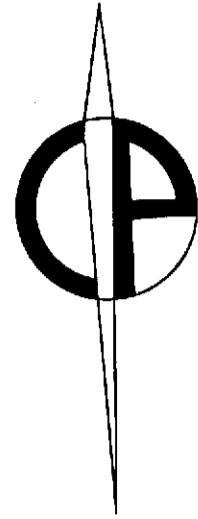

APPROVED BY BOARD OF ESTIMATE

CALENDAR # 36

DATE 1-28-88  
A-1487

CITY PLANNING COMMISSION  
CITY OF NEW YORK

DIAGRAM SHOWING PROPOSED  
ZONING CHANGE  
ON SECTIONAL MAP

10b  
BOROUGH OF  
QUEENS

New York, Certification Date  
September 14, 1987

*Anthony J. Patrici*  
Deputy Director for Technical  
Review, Land Use Review Division

*Anthony J. Patrici, P.E.*  
Chief Engineer

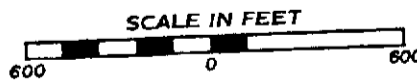

NOTE:

- indicates Zoning District boundary.
- The area enclosed by the fine dotted line is proposed to be changed from an R5 District to an R6 District.
- indicates a CI-2 District.
- indicates a C2-2 District.

richard campanelli

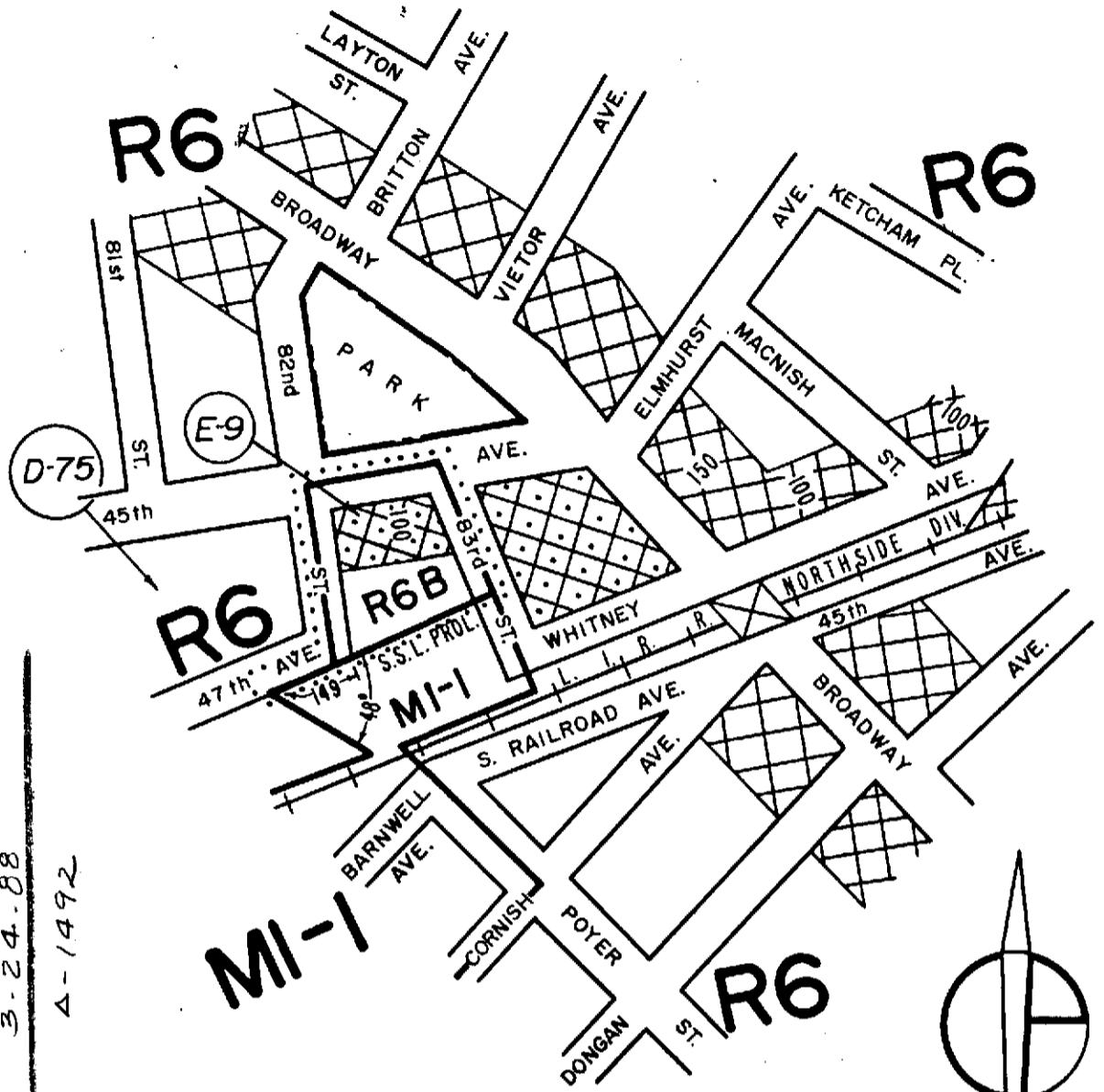

APPROVED BY BOARD OF ESTIMATE

CALENDAR # 32

DATE 3-24-88

4-1492

CITY PLANNING COMMISSION  
CITY OF NEW YORK

DIAGRAM SHOWING PROPOSED  
ZONING CHANGE  
ON SECTIONAL MAP

9d

BOROUGH OF  
QUEENS

New York, Certification Date  
November 2, 1987  
Modified  
March 24, 1988

*[Signature]*  
Deputy Director for Technical Review,  
Land Use Review Division

*[Signature]* P.E.  
Chief Engineer



NOTE:

- indicates Zoning District boundary.
- The area enclosed by the fine dotted line is proposed to be changed from an MI-1 District to R6 and R6B Districts, and establishing a C2-2 District within the proposed R6B District.
- indicates a C2-2 District.
- indicates a Restrictive Declaration Area.
- indicates a C1-2 District.
- City Environmental Quality Review Declaration, for detail refer to C.E.Q.R. sheet.

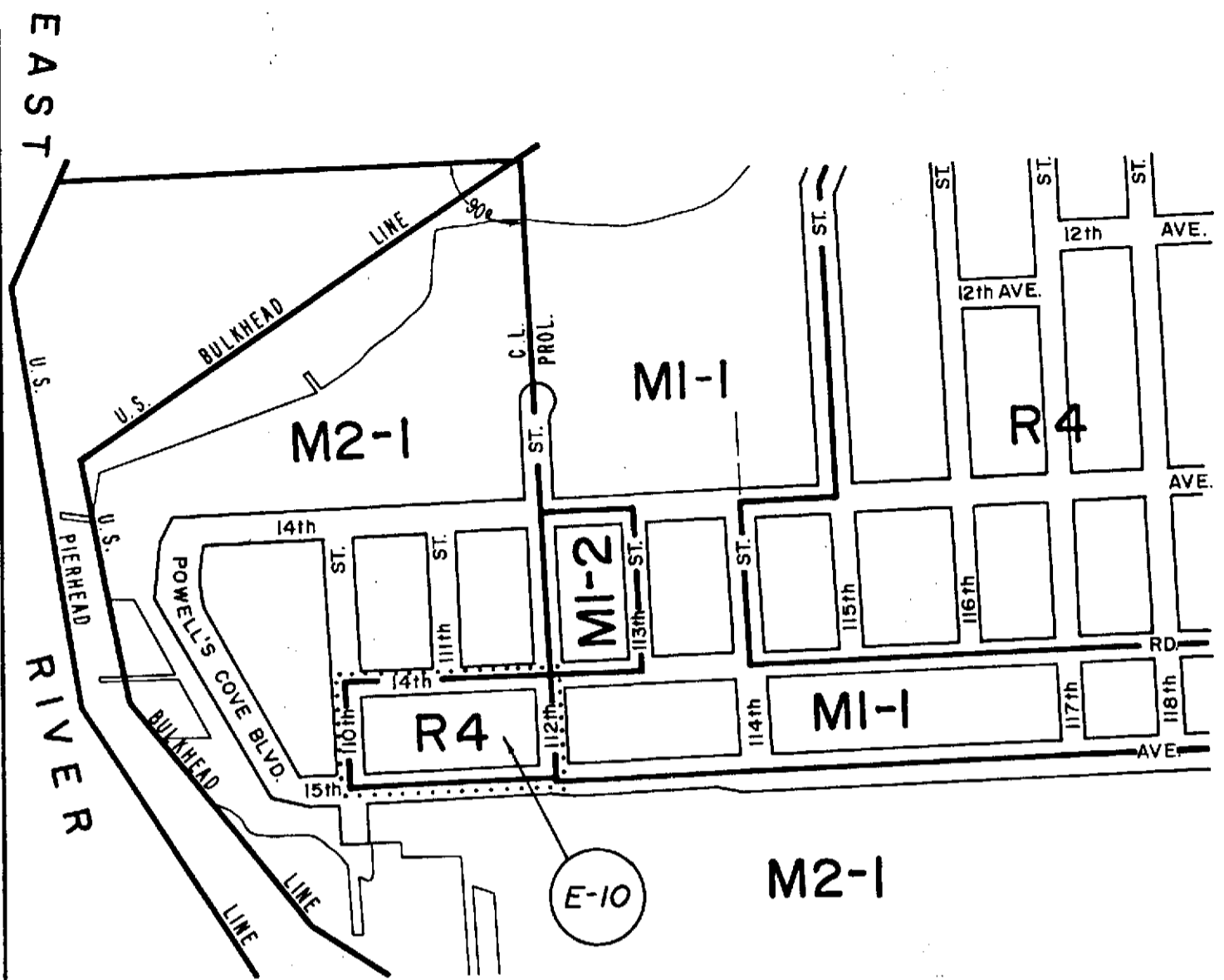

APPROVED BY BOARD OF ESTIMATE

CALENDAR # 74

DATE 6-9-88  $\Delta$ -1498

CITY PLANNING COMMISSION  
CITY OF NEW YORK

DIAGRAM SHOWING PROPOSED  
ZONING CHANGE  
ON SECTIONAL MAP

7b

BOROUGH OF  
QUEENS

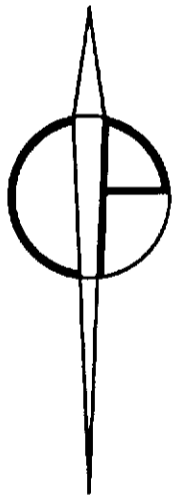

New York, Certification Date  
January 25, 1988

*[Signature]*  
Deputy Director for Technical Review,  
Land Use Review Division

*[Signature]*, P.E.  
Chief Engineer

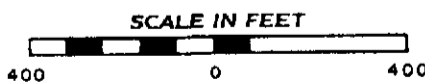

**NOTE:**

**—————** indicates Zoning District boundary.

**.....** The area enclosed by the fine dotted line is proposed to be changed from an M2-1 District to an R4 District.



City Environmental Quality Review Declaration, for detail refer to C.E.Q.R. sheet.

APPROVED BY BOARD OF ESTIMATE

CALENDAR # 19

DATE 8-11-88 Δ-1500

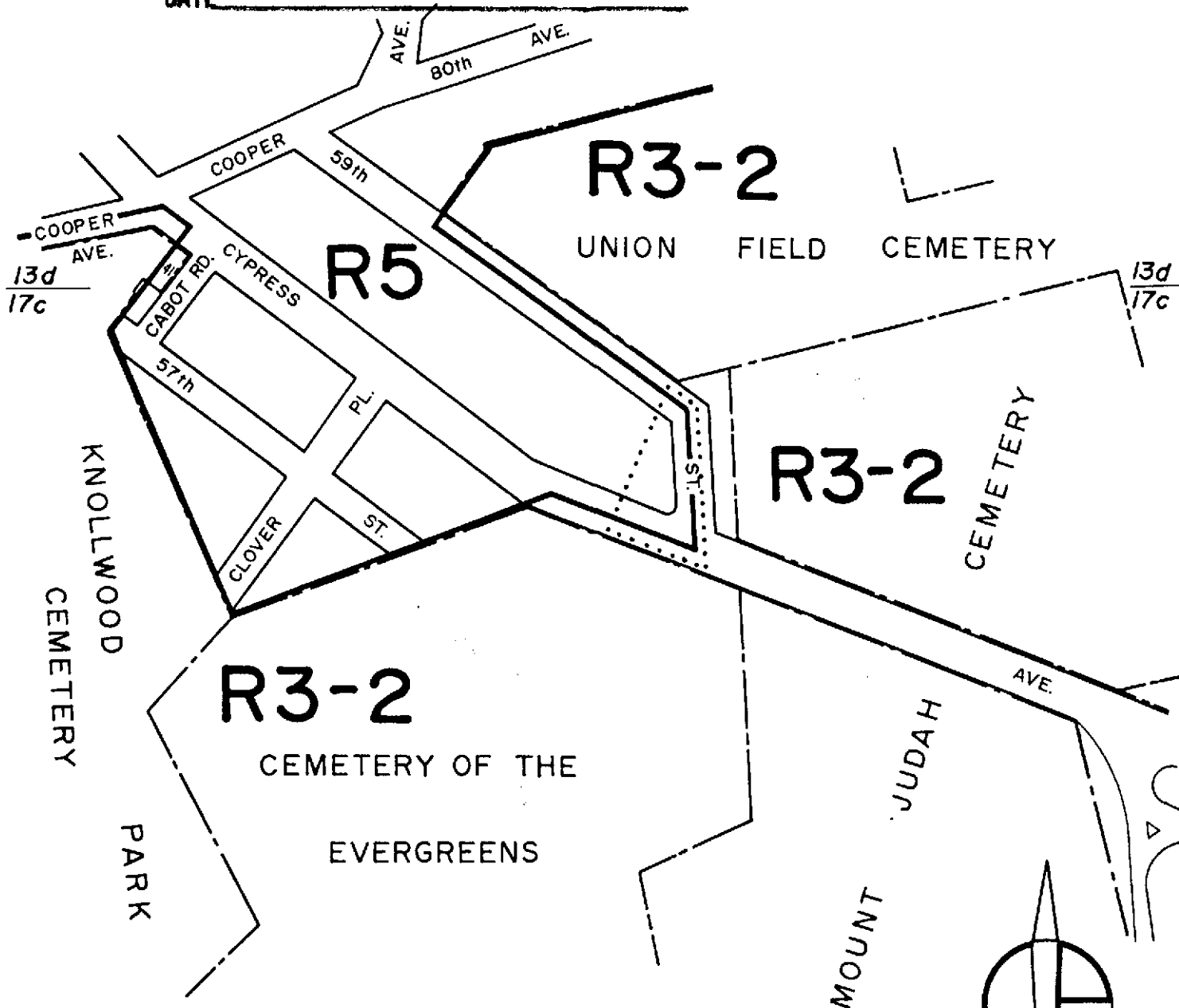

CITY PLANNING COMMISSION  
CITY OF NEW YORK

DIAGRAM SHOWING PROPOSED  
ZONING CHANGE  
ON SECTIONAL MAP

17c  
BOROUGH OF  
QUEENS

New York, Certification Date  
February 29, 1988

*[Signature]*  
Deputy Director for Technical Review,  
Land Use Review Division  
*Anthony J. Patrisi, P.E.*  
Chief Engineer

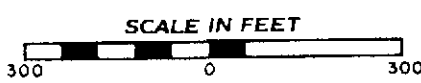

- NOTE:**
- indicates Zoning District boundary.
  - .....** The area enclosed by the fine dotted line is proposed to be changed from an R3-2 District to an R5 District.



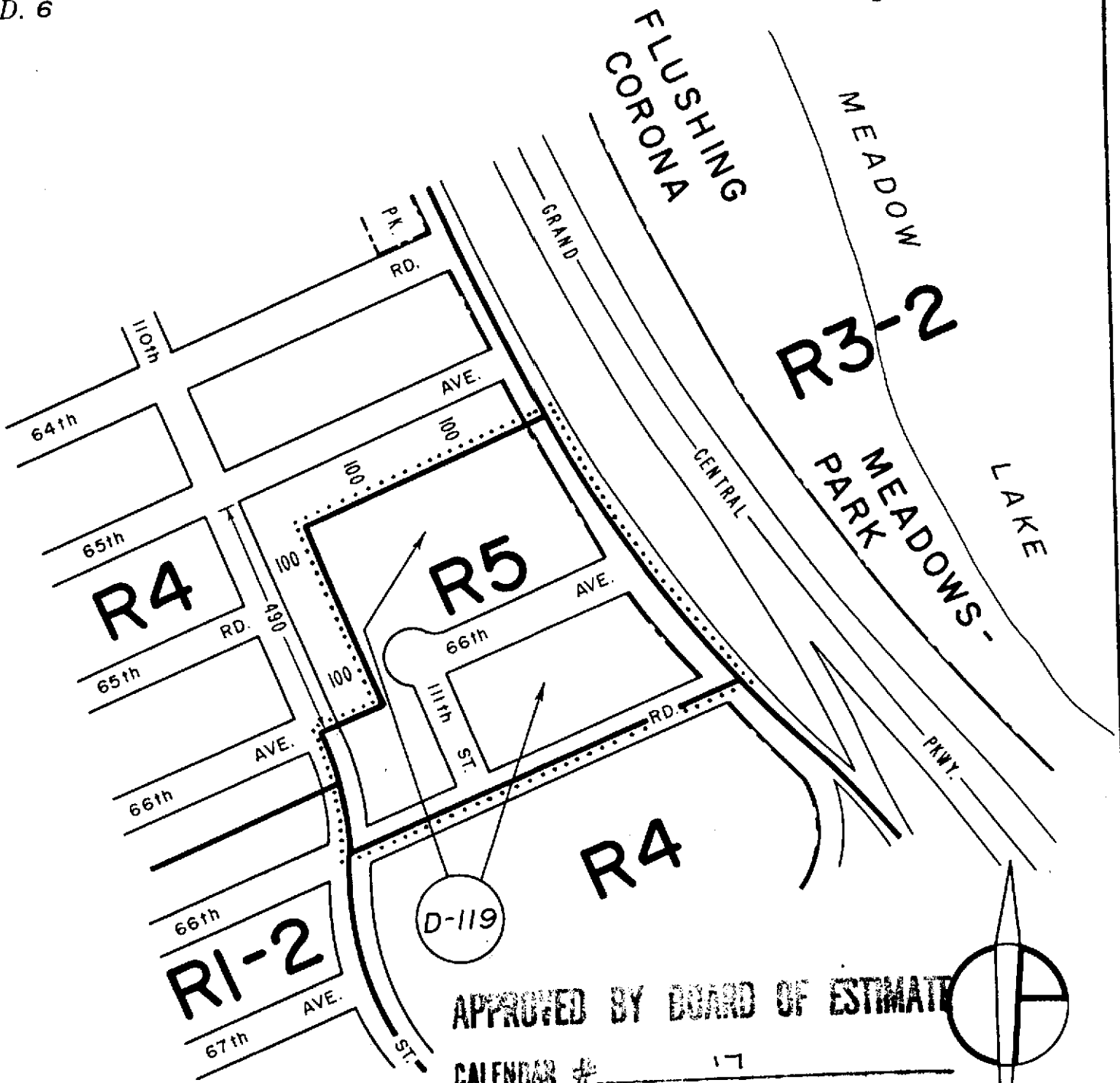

APPROVED BY BOARD OF ESTIMATE

CALENDAR # 17

DATE 8-11-88

Δ-1499

CITY PLANNING COMMISSION  
CITY OF NEW YORK



**DIAGRAM SHOWING PROPOSED  
ZONING CHANGE  
ON SECTIONAL MAP  
14a**

BOROUGH OF  
QUEENS

New York, Certification Date  
February 29, 1988

*[Signature]*  
Deputy Director for Technical Review,  
Land Use Review Division  
*[Signature]* Anthony Patrucci, P.E.  
Chief Engineer



**NOTE:**

- indicates Zoning District boundary.
- .....** The area enclosed by the fine dotted line is proposed to be changed from an R4 District to an R5 District.
- (D)** indicates a Restrictive Declaration Area.

APPROVED BY BOARD OF ESTIMATE

CALENDAR # 28

DATE 9.8.88

A-1505

R4

MI-1

ST. MICHAEL'S

CEMETERY

R4

MI-1

R5

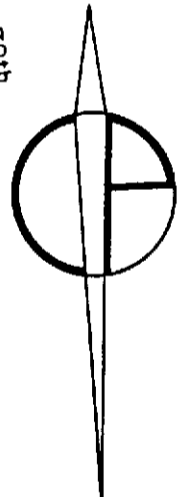
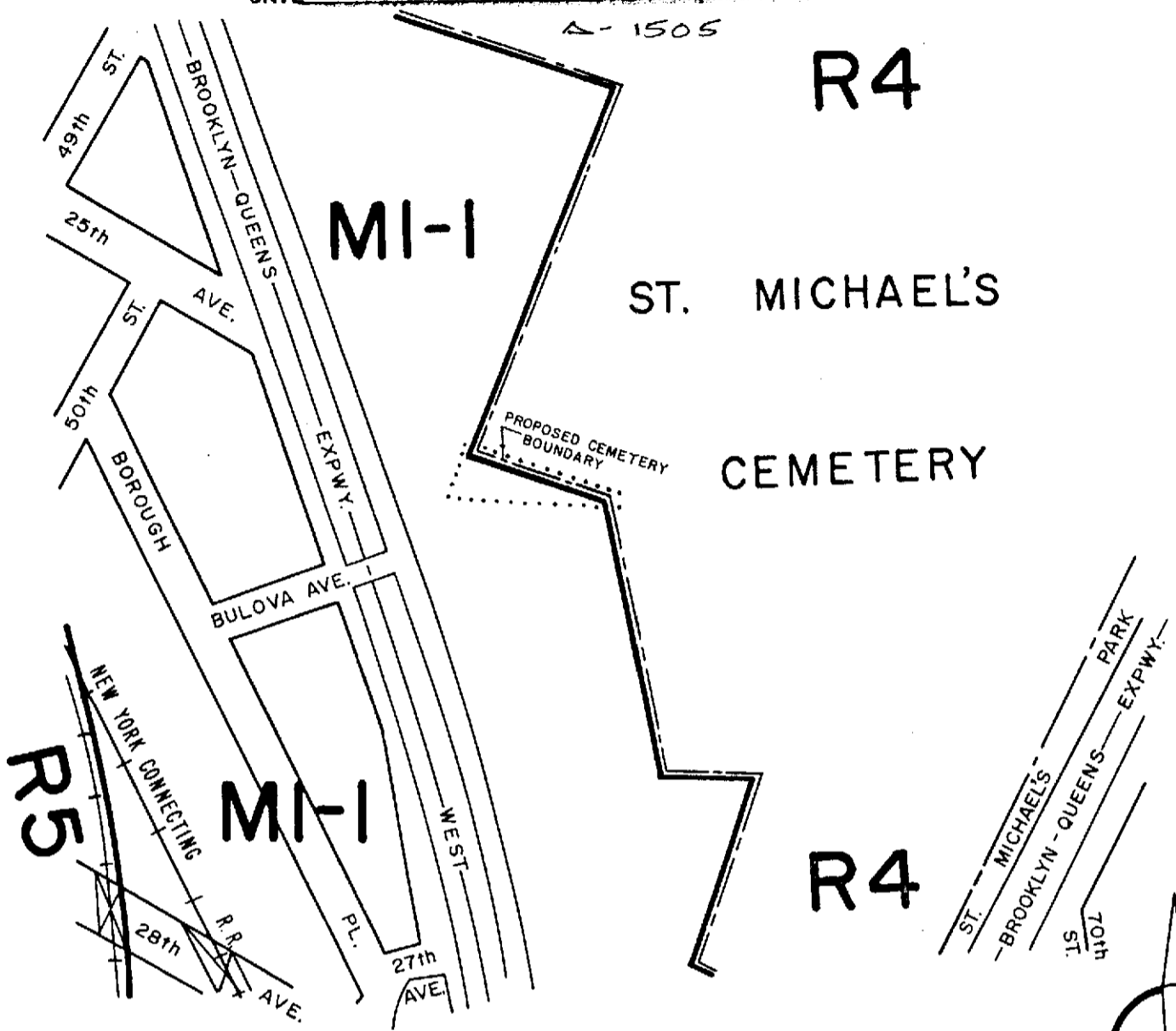

CITY PLANNING COMMISSION  
CITY OF NEW YORK

DIAGRAM SHOWING PROPOSED  
ZONING CHANGE  
ON SECTIONAL MAP

9c  
BOROUGH OF  
QUEENS

New York, Certification Date  
**April 18, 1988**

*Robert Hochfeld*  
Acting Deputy Director for Technical Review,  
Land Use Review Division

*Anthony J. Patrucci, P.E.*  
Chief Engineer

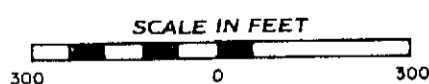

**NOTE:**

- indicates Zoning District boundary.
- .....** The area enclosed by the fine dotted line comprising an area of approximately 9053 square feet, is proposed to be changed from an R4 District to an MI-1 District.

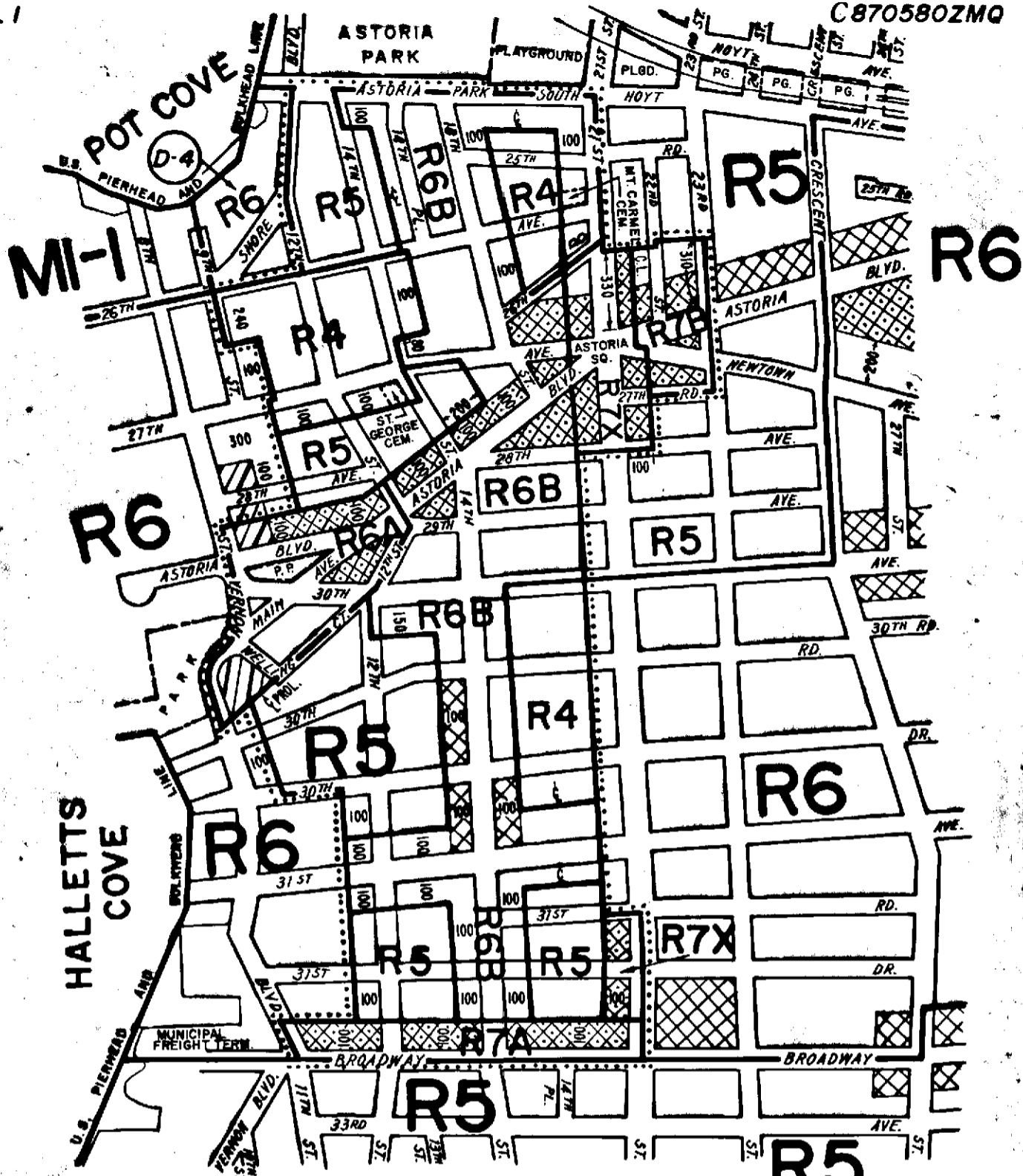

CITY PLANNING COMMISSION  
CITY OF NEW YORK

**DIAGRAM SHOWING PROPOSED  
ZONING CHANGE  
ON SECTIONAL MAP**

**9a  
BOROUGH OF  
QUEENS**

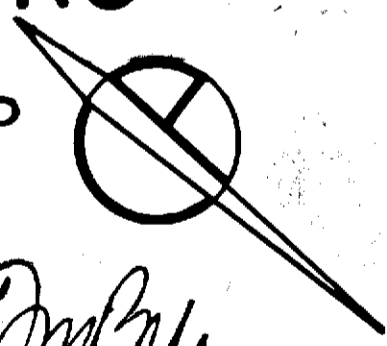

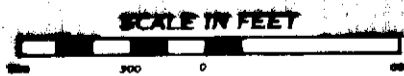

New York, Certification Date  
**April 10, 1989**  
Modified August 9, 1989

*[Signature]*  
Deputy Director for Technical Review,  
Land Use Review Division  
*[Signature]* **Patroni, P.E.**  
Chief Engineer

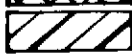

**NOTE:**

- Indicates Zoning District boundary.
- .....** The area enclosed by the fine dotted line is proposed to be changed from R5 and R6 Districts to R4, R5, R6A, R6B, R7A, R7B, and R7X Districts and by establishing C2-2 Districts in the proposed R6A, R6B, R7A, and R7X Districts, and by eliminating C1-2 and C2-2 Districts from the existing R5 and R6 Districts.
-  indicates a C1-2 District.
-  indicates a C1-3 District.
- (D)** indicates a Restrictive Declaration Area.  indicates a C2-2 District.

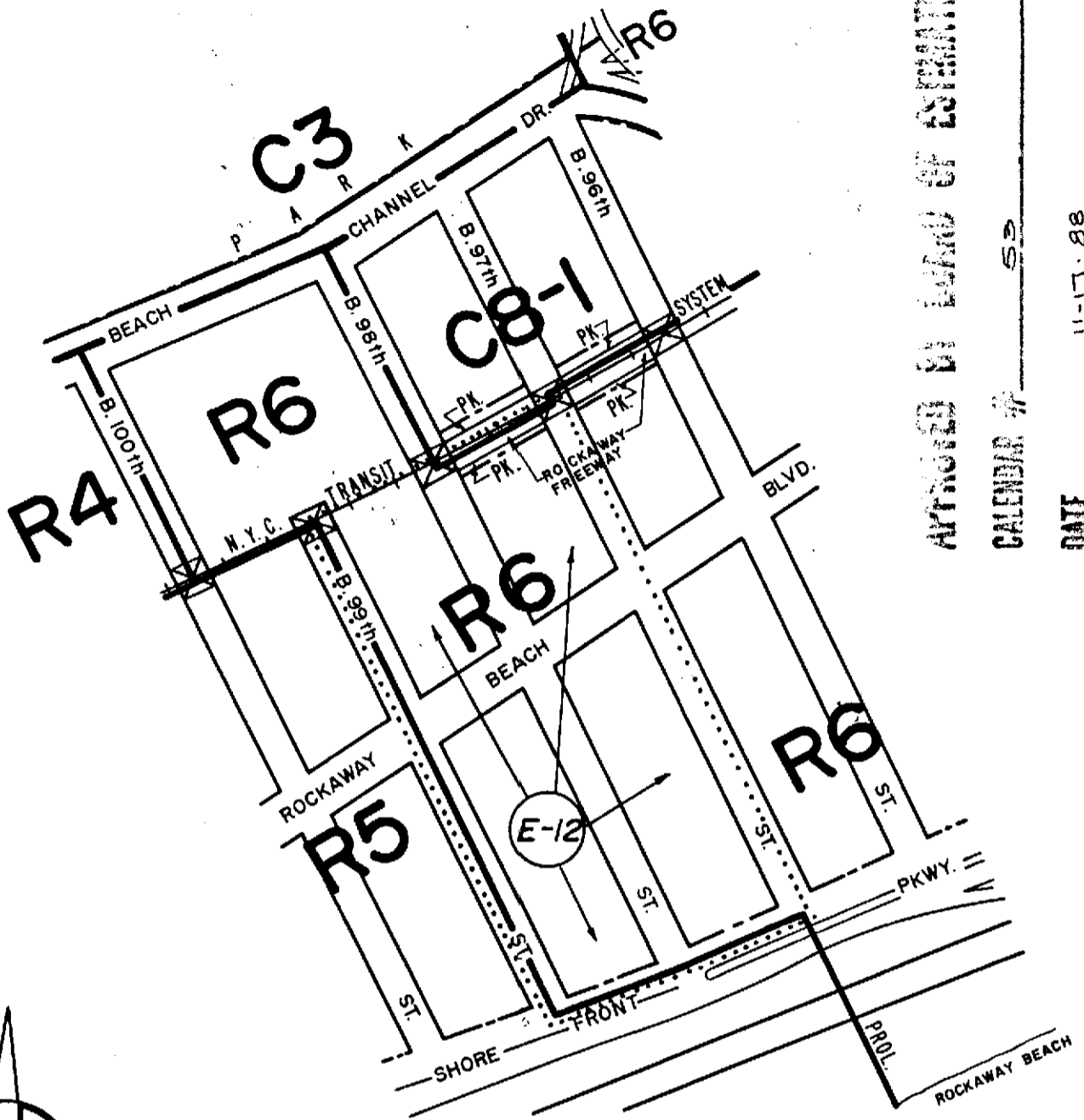

APPROVED BY BOARD OF ESTIMATES

CALENDAR # 52

DATE 11-17-88  
A-1511

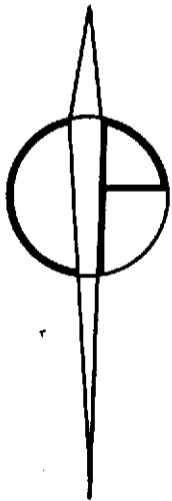

CITY PLANNING COMMISSION  
CITY OF NEW YORK

**DIAGRAM SHOWING PROPOSED  
ZONING CHANGE  
ON SECTIONAL MAP**

**30c**

**BOROUGH OF  
QUEENS**

New York, Certification Date  
**June 27, 1988**

*Anthony J. Patrici, P.E.*  
Deputy Director for Technical Review,  
Land Use Review Division  
Chief Engineer



**NOTE:**

- indicates Zoning District boundary.
- .....** The area enclosed by the fine dotted line is proposed to be changed from C7, R5 and C1-2 Districts to an R6 District.
- (E)** indicates a City Environmental Quality Review Declaration, for detail refer to C.E.Q.R. sheet.

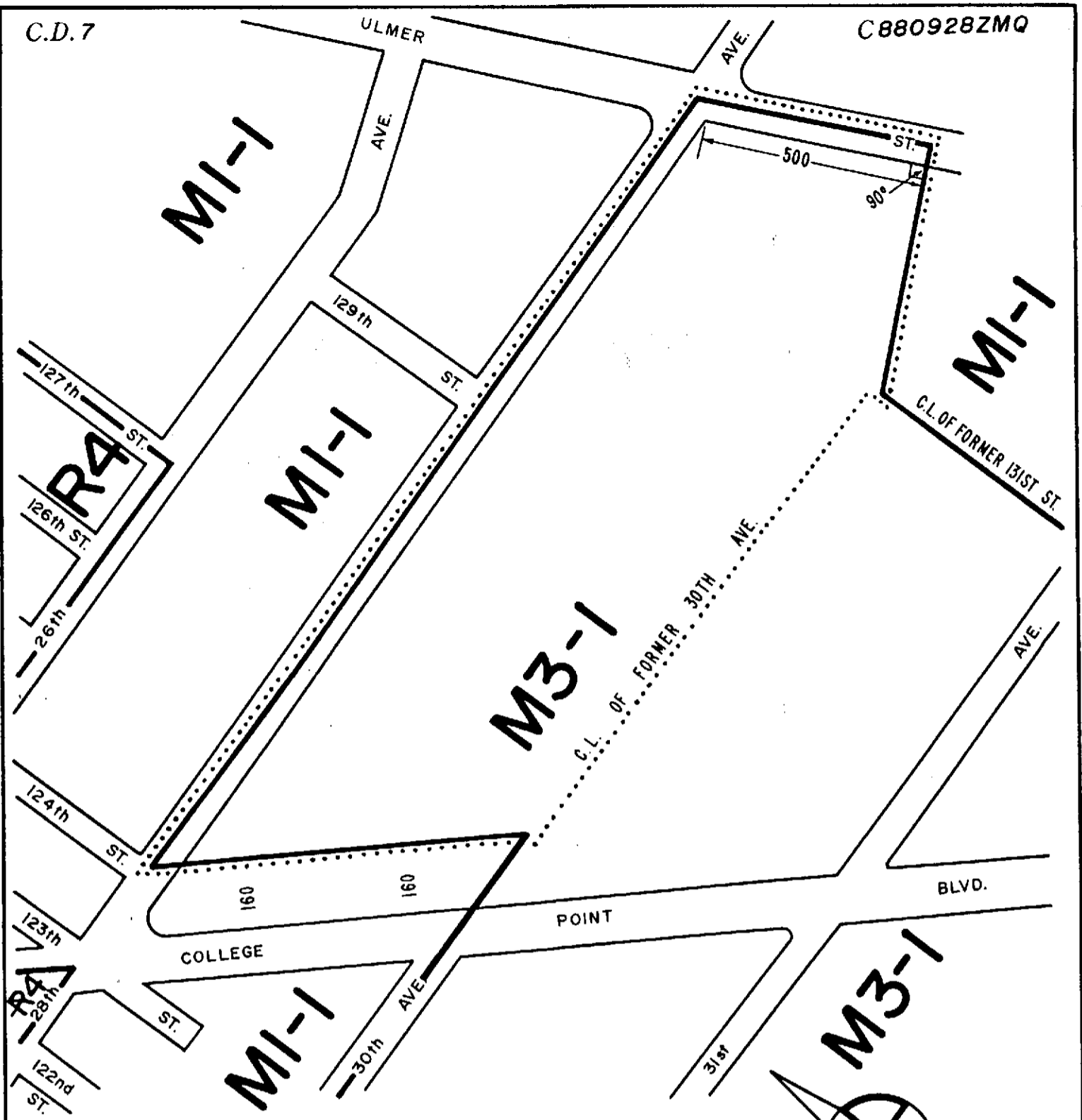

CITY PLANNING COMMISSION  
CITY OF NEW YORK

**DIAGRAM SHOWING PROPOSED  
ZONING CHANGE  
ON SECTIONAL MAP**

**10a  
BOROUGH OF  
QUEENS**

New York, Certification Date  
**June 27, 1988**  
Modified by B.O.E.  
**December 15, 1988**

*[Signature]*  
Deputy Director for Technical Review,  
Land Use Review Division  
*[Signature]* P.E.  
Acting Chief Engineer



**NOTE:**

- indicates Zoning District boundary.
- .....** The area enclosed by the fine dotted line is proposed to be changed from an MI-1 District to an M3-1 District.

**APPROVED BY BOARD OF ESTIMATE**

CALENDAR 77 28

DATE 12-15-88

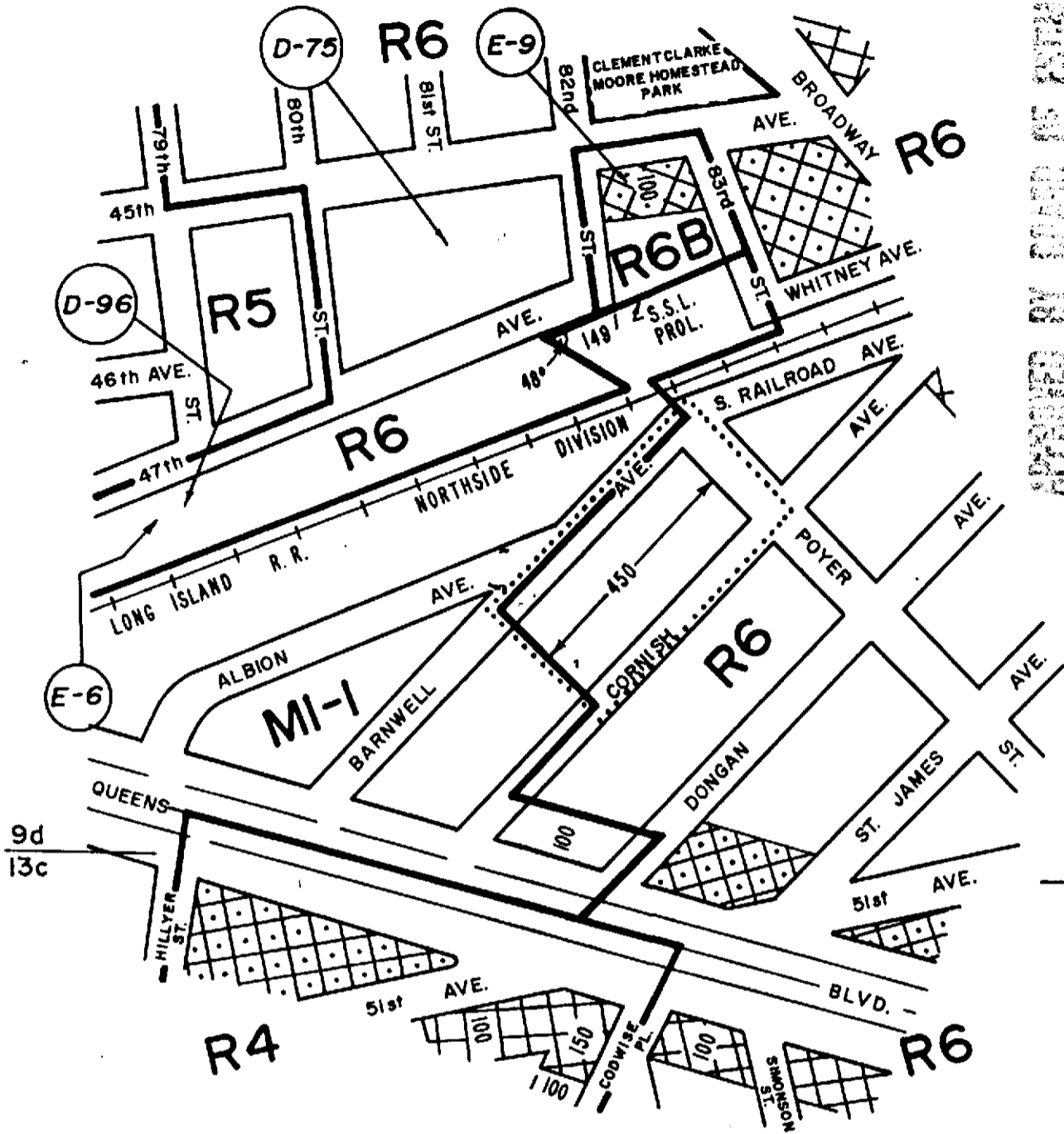

APPROVED BY BOARD OF ZONING

CALENDAR # 34

DATE 1-26-89

A-1519

CITY PLANNING COMMISSION  
CITY OF NEW YORK

**DIAGRAM SHOWING PROPOSED  
ZONING CHANGE  
ON SECTIONAL MAP**

**9d  
BOROUGH OF  
QUEENS**

New York, Certification Date  
**August 22, 1988**

*DynBork*  
Deputy Director for Technical Review,  
Land Use Review Division

*Anthony J. Paternis, P.E.*  
Chief Engineer



**NOTE:**

- indicates Zoning District boundary.
- The area enclosed by the fine dotted line is proposed to be changed from an MI-1 District to an R6 District.
- indicates a C1-2 District.
- indicates a C2-2 District.
- indicates a Restrictive Declaration Area.
- indicates a City Environmental Quality Review Declaration, for detail refer to C.E.Q.R sheet.

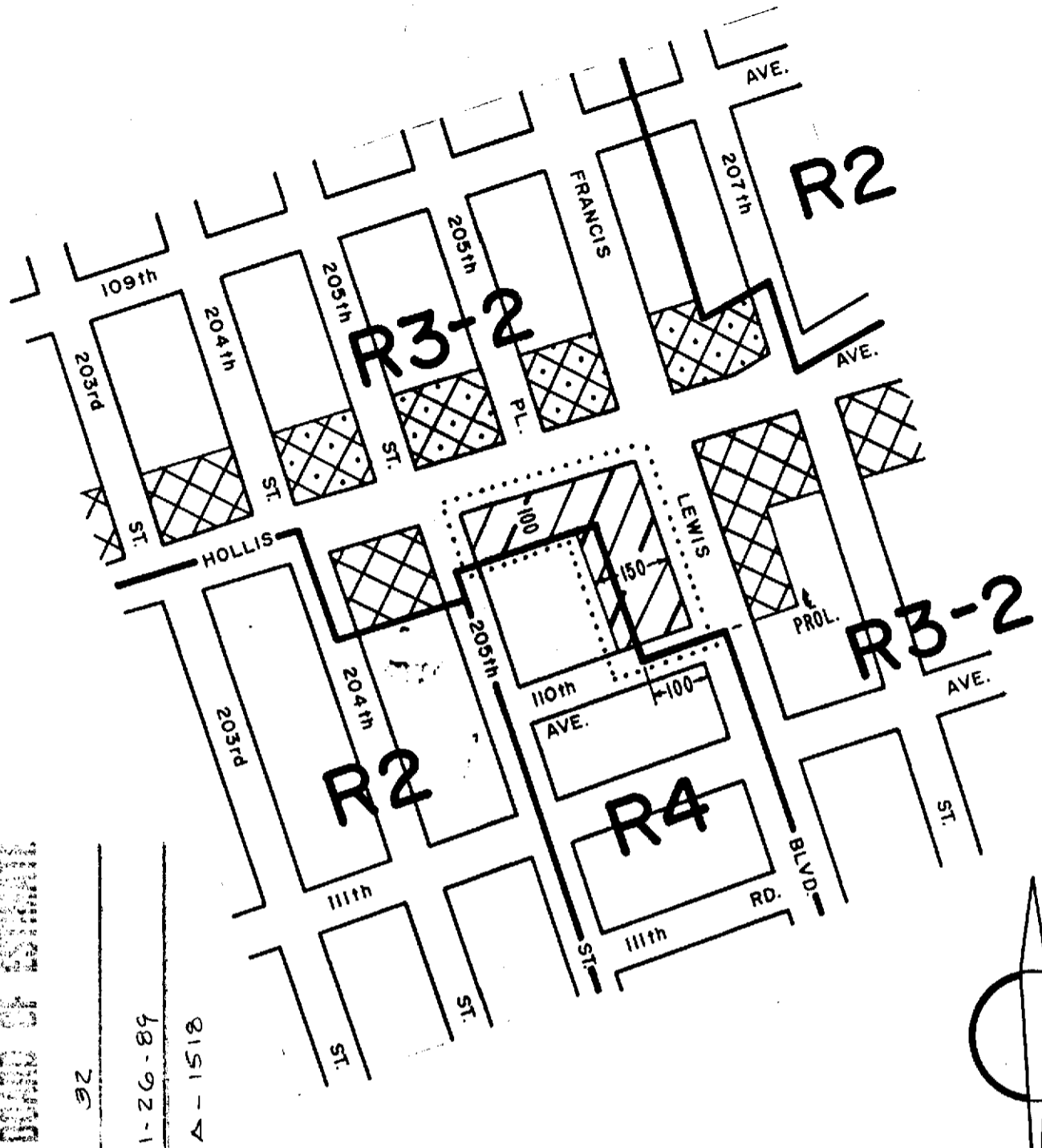

APPROVED BY BOARD OF ESTIMATES

CALENDAR # 92

DATE 1-26-89

A-1518

CITY PLANNING COMMISSION  
CITY OF NEW YORK

**DIAGRAM SHOWING PROPOSED  
ZONING CHANGE  
ON SECTIONAL MAP**

**15b**

**BOROUGH OF  
QUEENS**

New York, Certification Date





**September 6, 1988**

*[Signature]*  
Deputy Director for Technical Review,  
Land Use Review Division

*[Signature]*  
Chief Engineer



**NOTE:**

-  indicates Zoning District boundary.
-  The area enclosed by the fine dotted line is proposed to be changed from a C1-2 District to a C1-3 District within an existing R3-2 District and by establishing a C1-3 District within an existing R4 District.
-  indicates a C1-2 District.
-  indicates a C2-2 District.
-  indicates a C1-3 District.

APPROVED BY BOARD OF ESTIMATE

CALENDAR # 35

DATE 3-30-89

A-1523

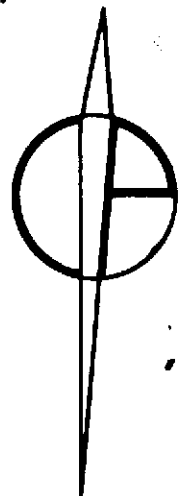
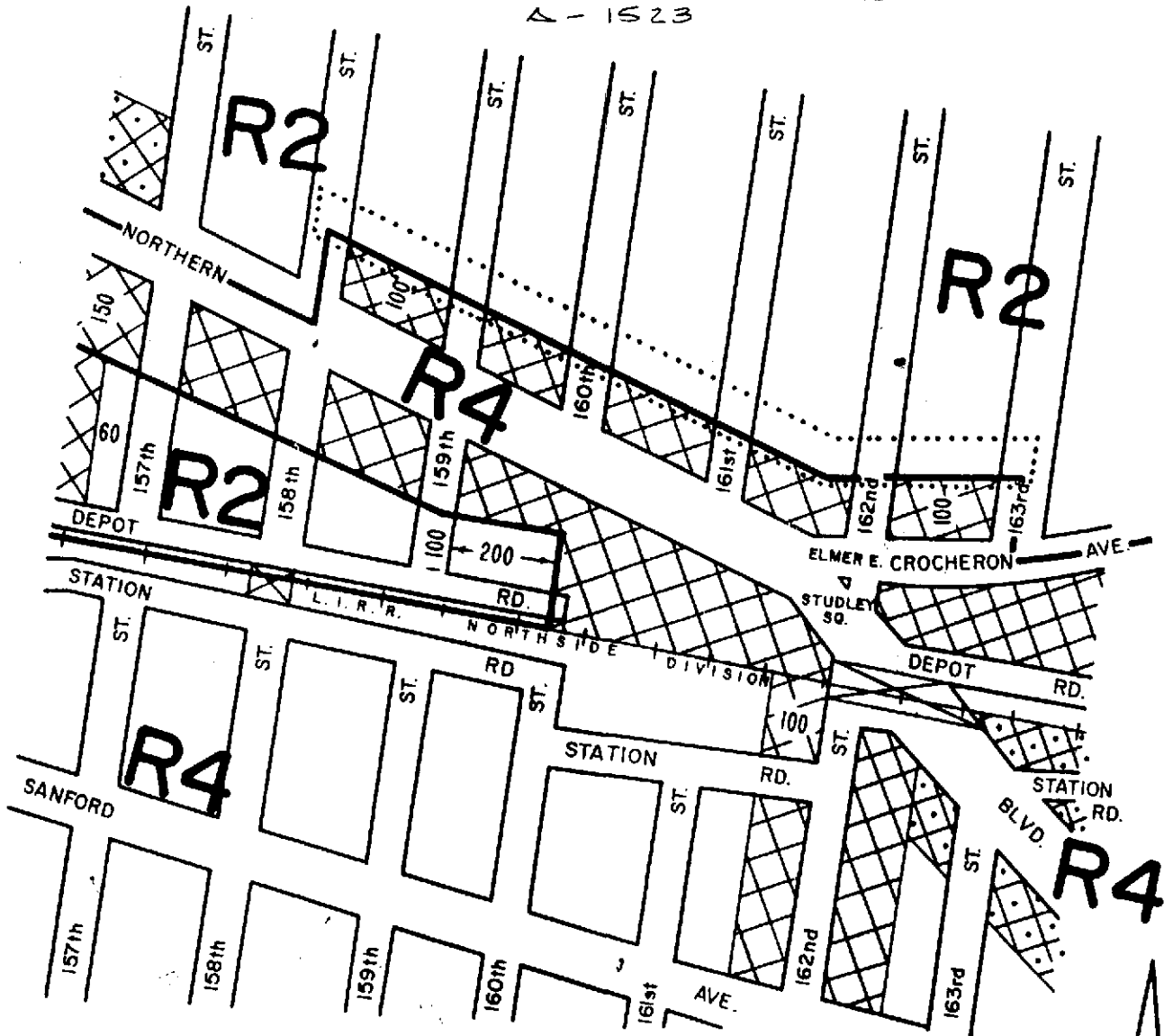

CITY PLANNING COMMISSION  
CITY OF NEW YORK

DIAGRAM SHOWING PROPOSED  
ZONING CHANGE  
ON SECTIONAL MAP  
10c

BOROUGH OF  
QUEENS





New York, Certification Date  
November 21, 1988

*John P. ...*  
Deputy Director for Technical Review,  
Land Use Review Division

*Anthony J. Paterniti, P.E.*  
Chief Engineer



NOTE:

-  indicates Zoning District boundary.
-  The area enclosed by the fine dotted line is proposed to be changed from CI-2 and R4 Districts to an R2 District.
-  indicates a CI-2 District.
-  indicates a C2-2 District.



APPROVED BY BOARD OF ESTIMATE

CALENDAR # 40

DATE 3-30-89

A-1524

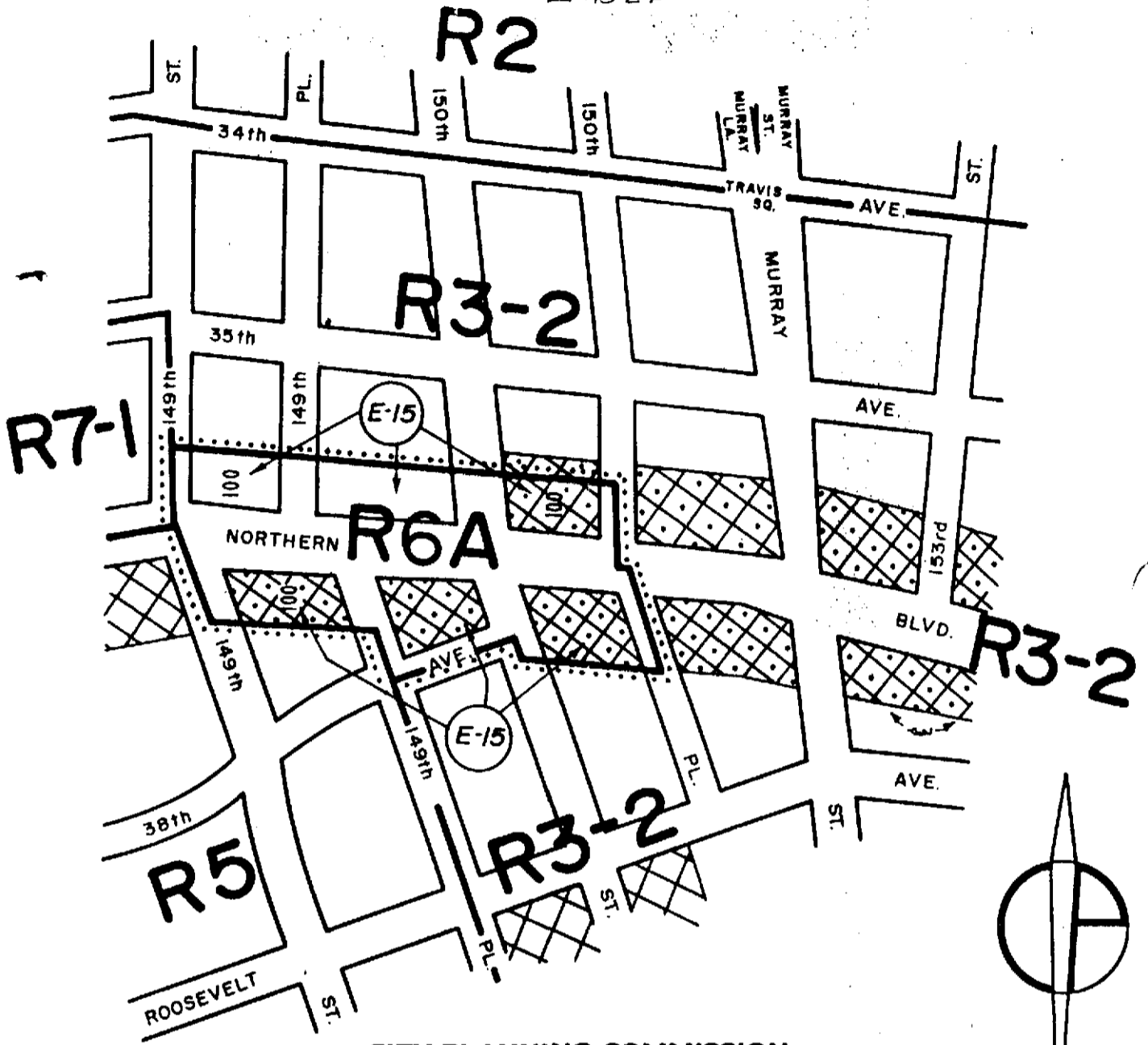

CITY PLANNING COMMISSION  
CITY OF NEW YORK

**DIAGRAM SHOWING PROPOSED  
ZONING CHANGE  
ON SECTIONAL MAP**

10c

BOROUGH OF  
QUEENS

New York, Certification Date  
October 3, 1988  
Modified by B.O.E.  
March 30, 1989

*Dan Berner*  
Deputy Director for Technical Review,  
Land Use Review Division

*Anthony J. Patrici, P.E.*  
Chief Engineer



**NOTE:**

- indicates Zoning District boundary.
- The area enclosed by the fine dotted line is proposed to be changed from an R3-2 District to an R6A District.
- indicates a C1-2 District.
- indicates a C2-2 District.
- indicates a City Environmental Quality Review Declaration, for detail refer to C.E.Q.R. sheet.

# R4

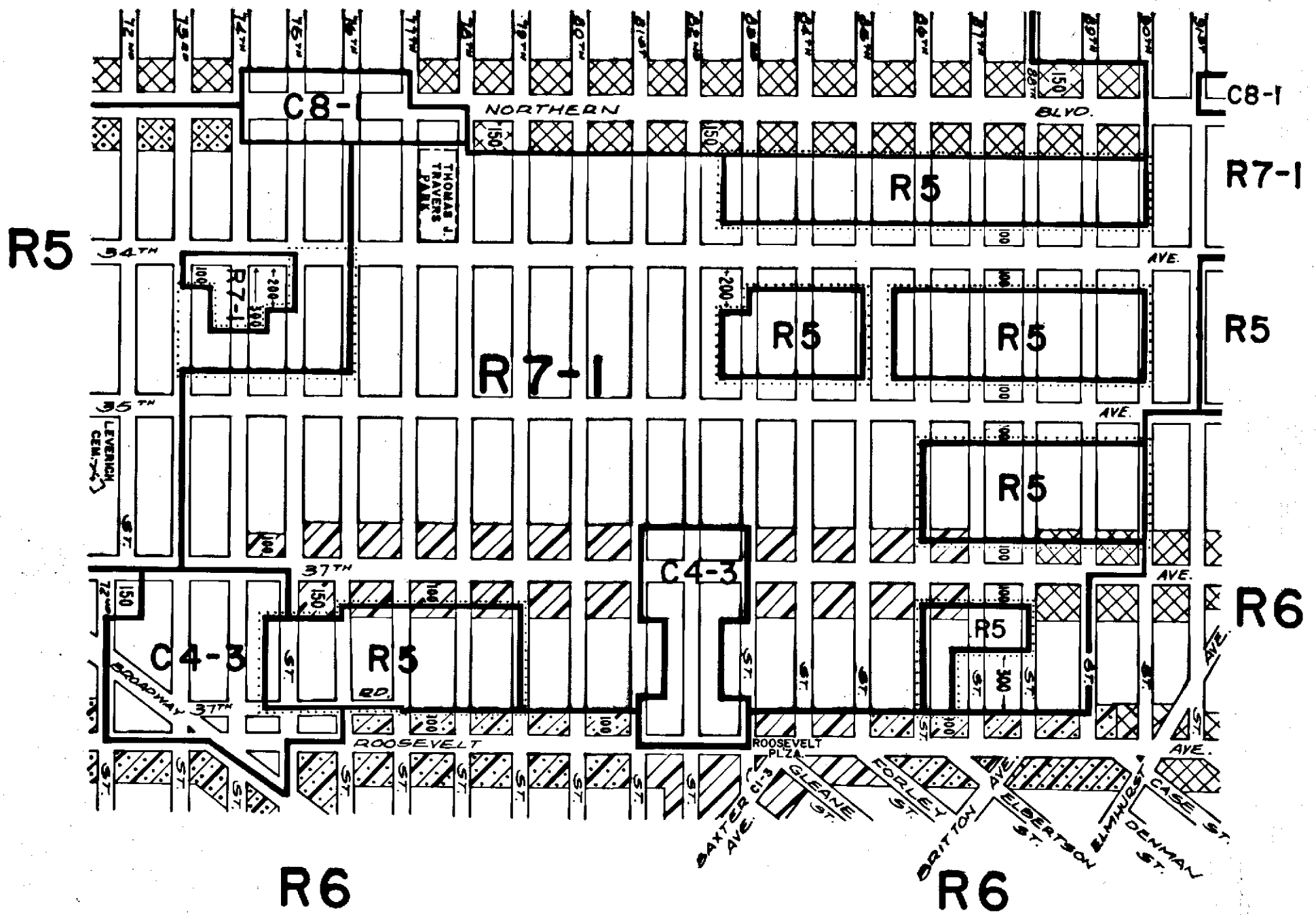

CITY PLANNING COMMISSION  
CITY OF NEW YORK

**DIAGRAM SHOWING PROPOSED  
ZONING CHANGE  
ON SECTIONAL MAP  
9d  
BOROUGH OF  
QUEENS**

New York, Certification Date  
**February 27, 1989**

*[Signature]*  
Deputy Director for Technical Review,  
Land Use Review Division  
**Anthony J. Patrone, P.E.**  
Chief Engineer



**NOTE:**

- indicates Zoning District boundary.
- The areas enclosed by the fine dotted lines are proposed to be changed from an R7-1 District to R5 Districts.
- indicates a C1-2 District.
- indicates a C1-3 District.
- indicates a C2-2 District.
- indicates a C2-3 District.

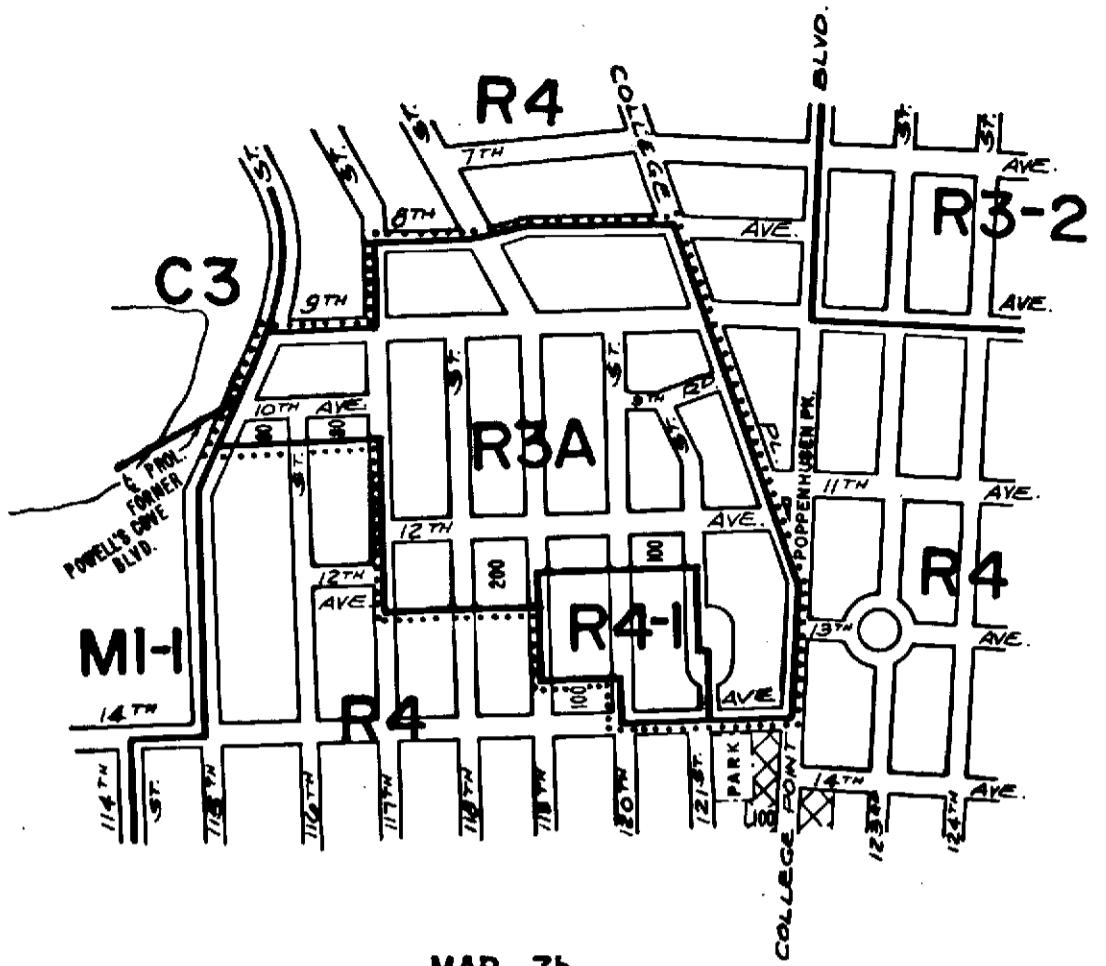

MAP 7b

CITY PLANNING COMMISSION  
 CITY OF NEW YORK  
 DIAGRAM SHOWING PROPOSED  
 ZONING CHANGE  
 ON SECTIONAL MAP  
 7b  
 BOROUGH OF  
 QUEENS

New York, Certification Date  
 March 6, 1989

*[Signature]*  
 Deputy Director for Technical Review,  
 Land Use Review Division  
*Anthony J. Patrisi, P.E.*  
 Chief Engineer



- NOTE:
- indicates Zoning District boundary.
  - The area enclosed by the fine dotted line is proposed to be changed from an R4 District to R3A and R4-1 Districts.
  - indicates a C1-2 District.

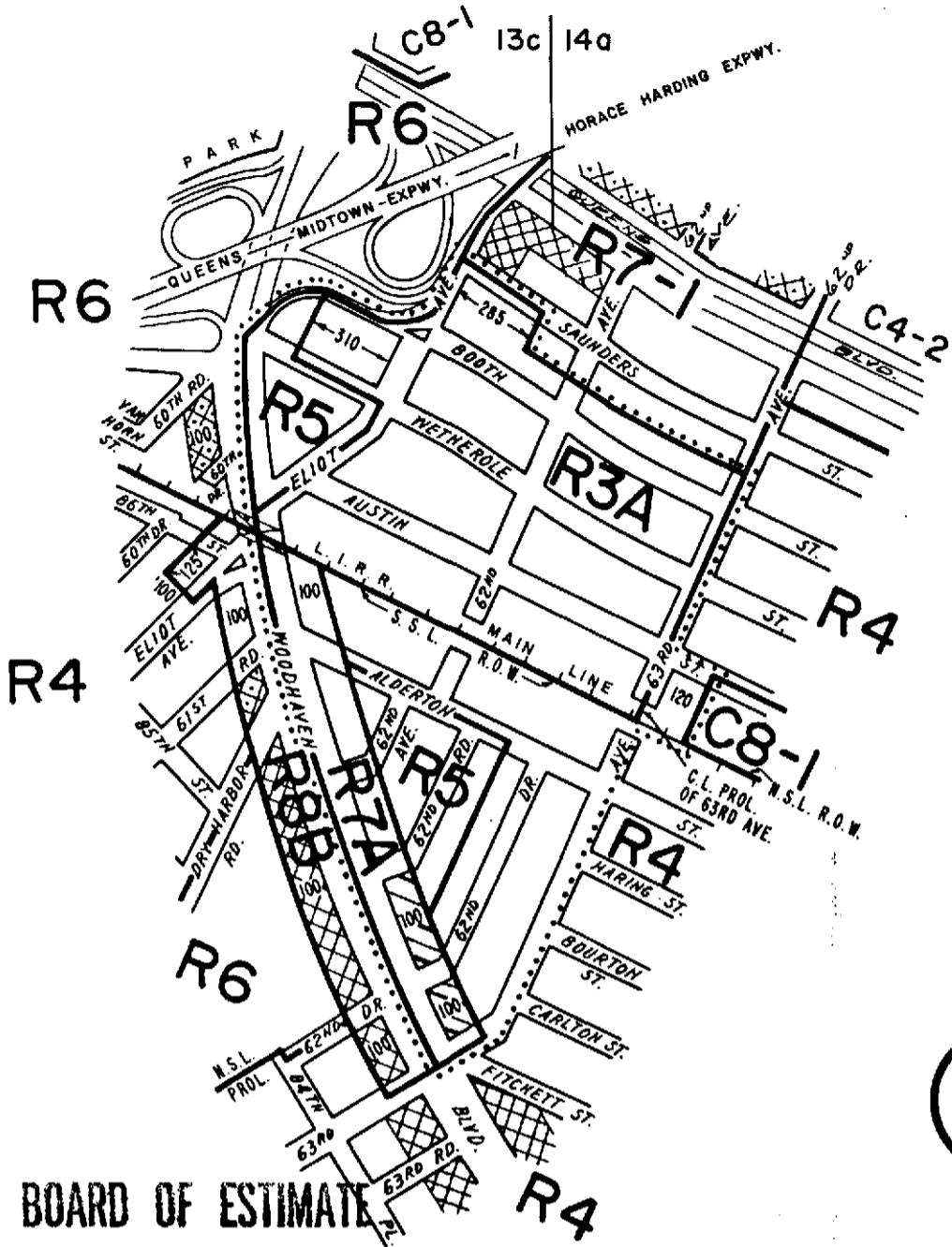

APPROVED BY BOARD OF ESTIMATE

CALENDAR # 5

DATE 7-20-89

13c | 14a

A-1533 CITY PLANNING COMMISSION  
CITY OF NEW YORK

**DIAGRAM SHOWING PROPOSED  
ZONING CHANGE  
ON SECTIONAL MAPS  
13c & 14a  
BOROUGH OF  
QUEENS**

New York, Certification Date  
March 20, 1989

*[Signature]*  
Deputy Director for Technical Review,  
Land Use Review Division  
*[Signature]* P.E.  
Acting Chief Engineer



- NOTE:**
- indicates Zoning District boundary.
  - The area enclosed by the fine dotted line is proposed to be changed from R6, R7-1 and C8-1 Districts to R3A, R4, R5 and R7A Districts and changing C1-2 Districts to C1-3 Districts within the proposed R7A District.
  - indicates a C1-2 District.
  - indicates a C2-2 District.
  - indicates a C1-3 District.

BEACH CHANNEL

MI-1

MI-1

M2-1

MI-1

R5

R5

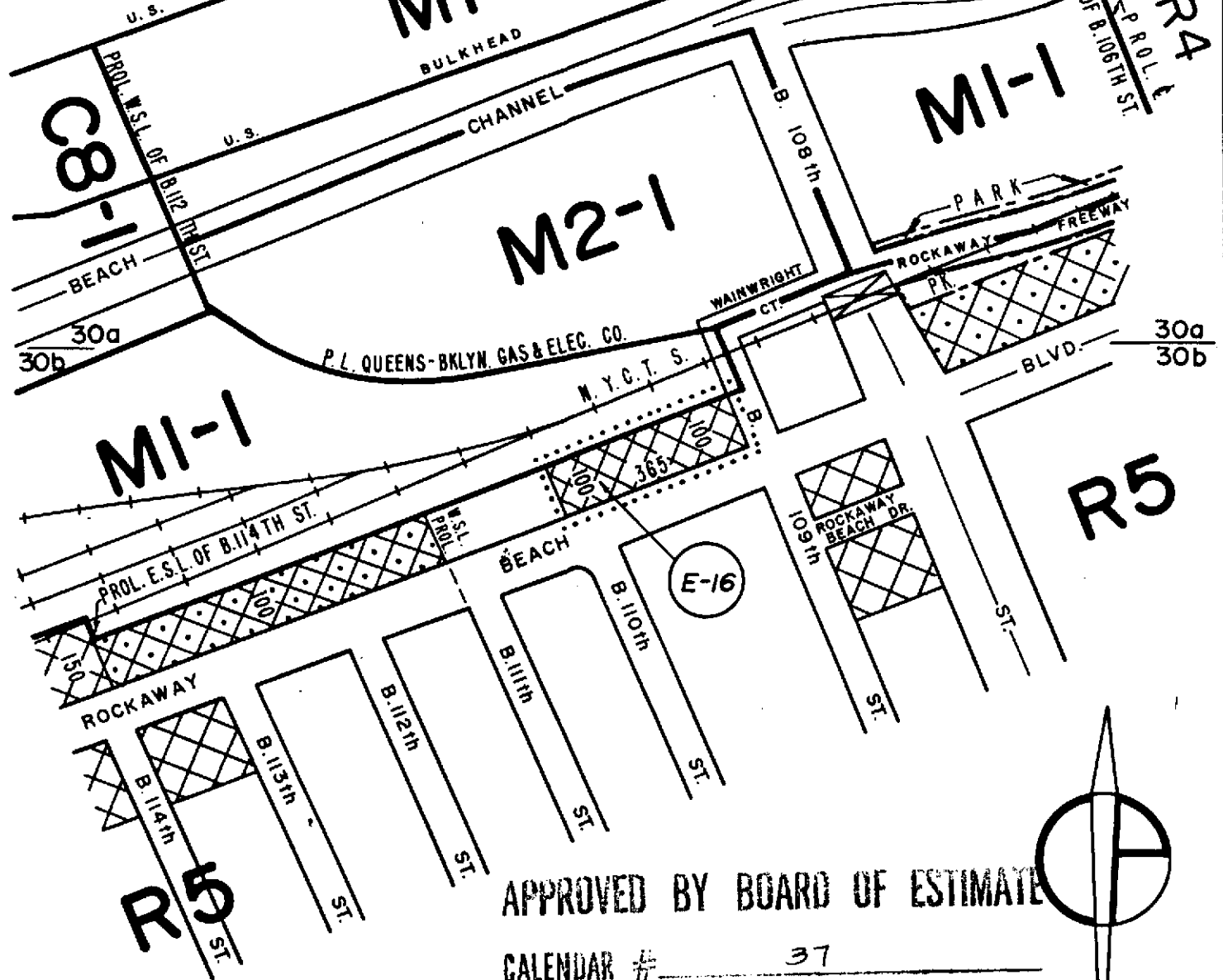

APPROVED BY BOARD OF ESTIMATE

CALENDAR # 37

DATE 8-17-89

CITY PLANNING COMMISSION A-1537  
CITY OF NEW YORK



DIAGRAM SHOWING PROPOSED  
ZONING CHANGE  
ON SECTIONAL MAP  
30b

BOROUGH OF  
QUEENS

New York, Certification Date  
March 20, 1989

*Anthony J. Patino*  
Deputy Director for Technical Review,  
Land Use Review Division  
Anthony J. Patino, P.E.  
Chief Engineer



NOTE:

- indicates Zoning District boundary.
- The area enclosed by the fine dotted line is proposed to be changed by establishing a CI-2 District within an existing R5 District.
- indicates a CI-2 District.
- indicates a C2-2 District.
- indicates a City Environmental Quality Review Declaration, for detail refer to C.E.Q.R. sheet.



CITY PLANNING COMMISSION  
CITY OF NEW YORK  
**DIAGRAM SHOWING PROPOSED  
ZONING CHANGES  
ON SECTIONAL MAPS  
9d,10b,13c,14a  
BOROUGH OF  
QUEENS**

New York, Certification Date  
April 28, 1989

*John Purves*  
Director of Technical Review,  
Land Use Review Division  
*Anthony J. Patricio, P.E.*  
Chief Engineer

SCALE IN FEET  
0 100 200 300 400

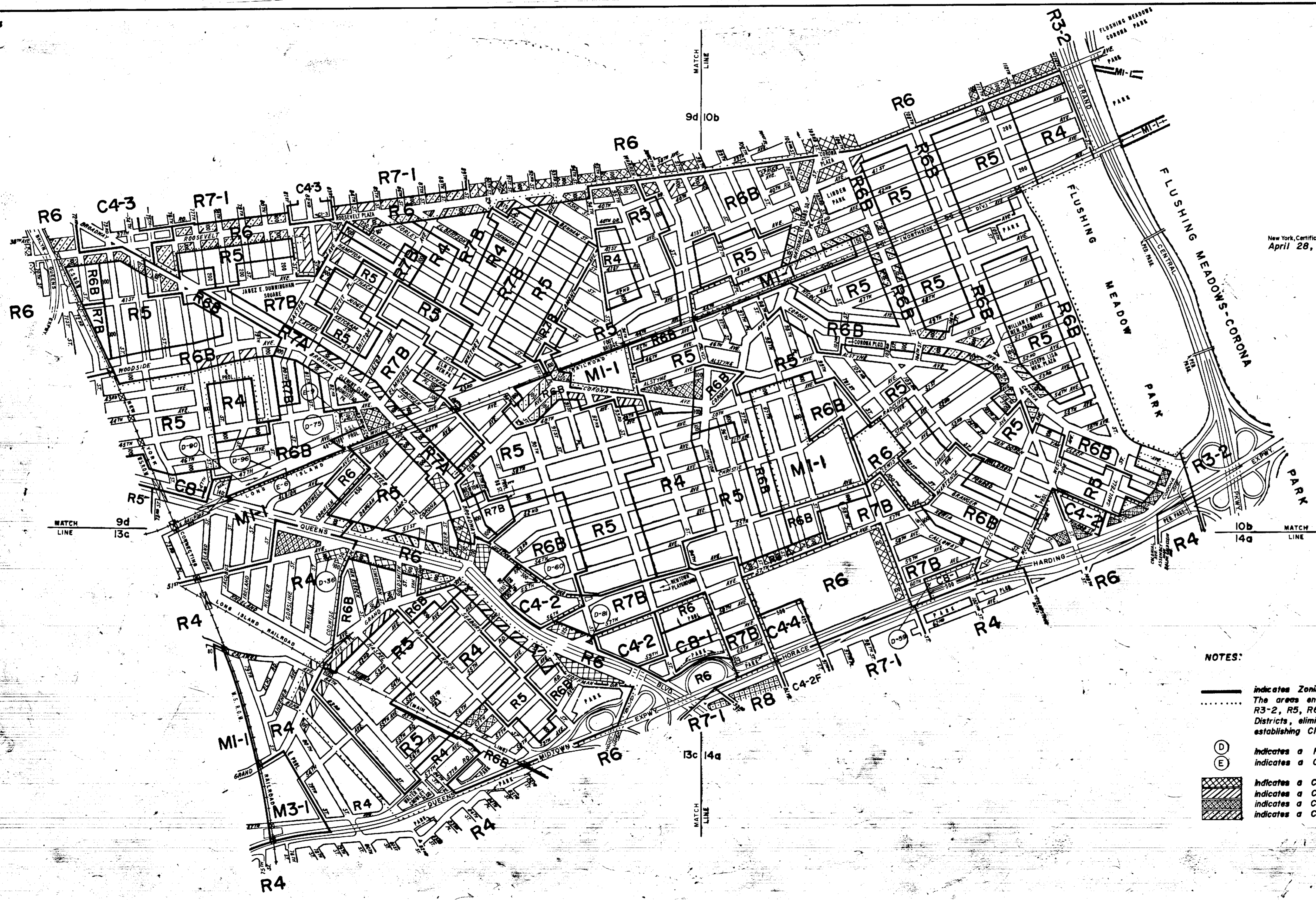

NOTES:

- indicates Zoning District boundary.
- ..... The areas enclosed by the fine dotted lines are proposed to be changed from R3-2, R5, R6 and MI-1 Districts to R4, R5, R6, R6A, R6B, R7A and R7B Districts, eliminating and changing C1-2, C1-3, C2-2 and C2-3 Districts and establishing C1-3 and C2-3 Districts within the existing and proposed zoning Districts.
- (D) indicates a Restrictive Declaration Area, refer to R.D. sheet.
- (E) indicates a City Environmental Quality Review Declaration, for detail refer to C.E.Q.R. sheet.
- [Hatched Box] indicates a C1-2 District.
- [Cross-hatched Box] indicates a C1-3 District.
- [Diagonal Lines] indicates a C2-2 District.
- [Vertical Lines] indicates a C2-3 District.

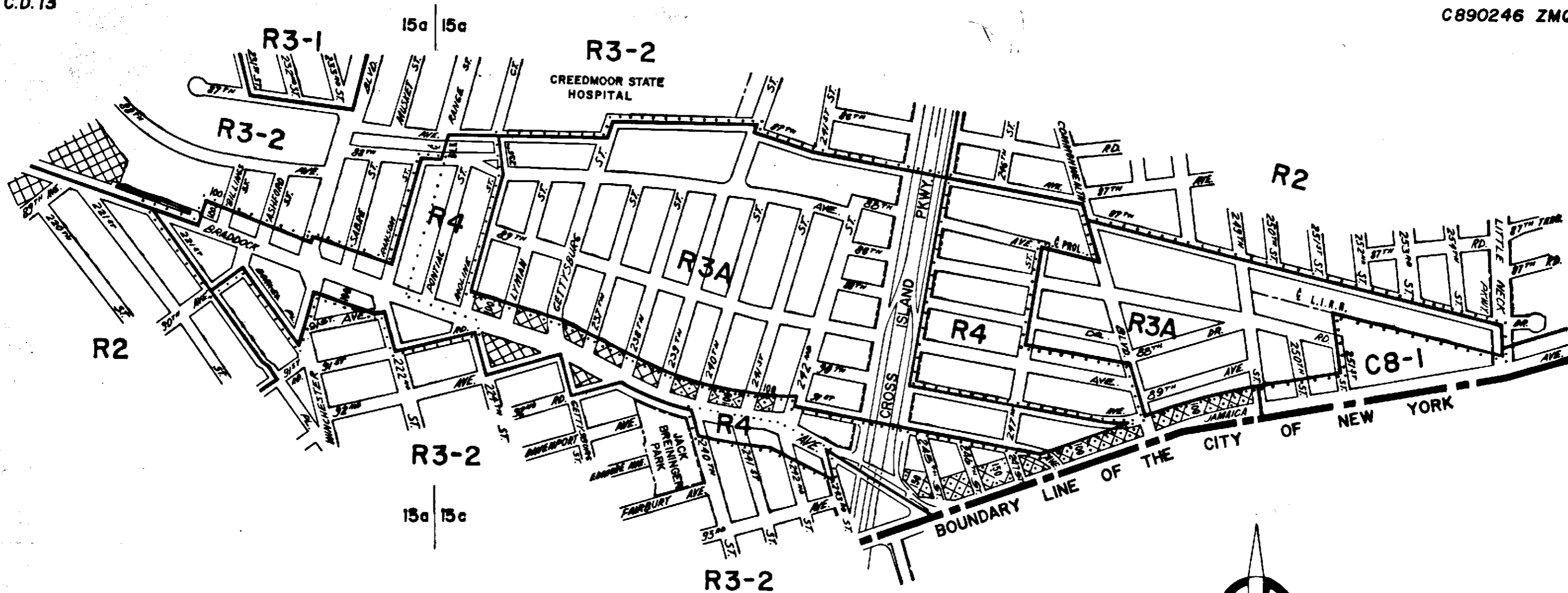

CITY PLANNING COMMISSION  
CITY OF NEW YORK

DIAGRAM SHOWING PROPOSED  
ZONING CHANGE  
ON SECTIONAL MAPS  
15a & 15c  
BOROUGH OF  
QUEENS

New York, Certification Date  
March 20, 1989  
Modified July 26, 1989



*Debra P. ...*  
Deputy Director for Technical Review,  
Land Use Review Division

Acting *James G. ...*, P.E.  
Chief Engineer

NOTE:

- indicates Zoning District boundary.
- The areas enclosed by the fine dotted lines are proposed to be changed from R4 and R3-2 Districts to R3A and R4 Districts and eliminating C1-2 and C2-2 Districts from the proposed R3A District.
- indicates a C1-2 District.
- indicates a C2-2 District.

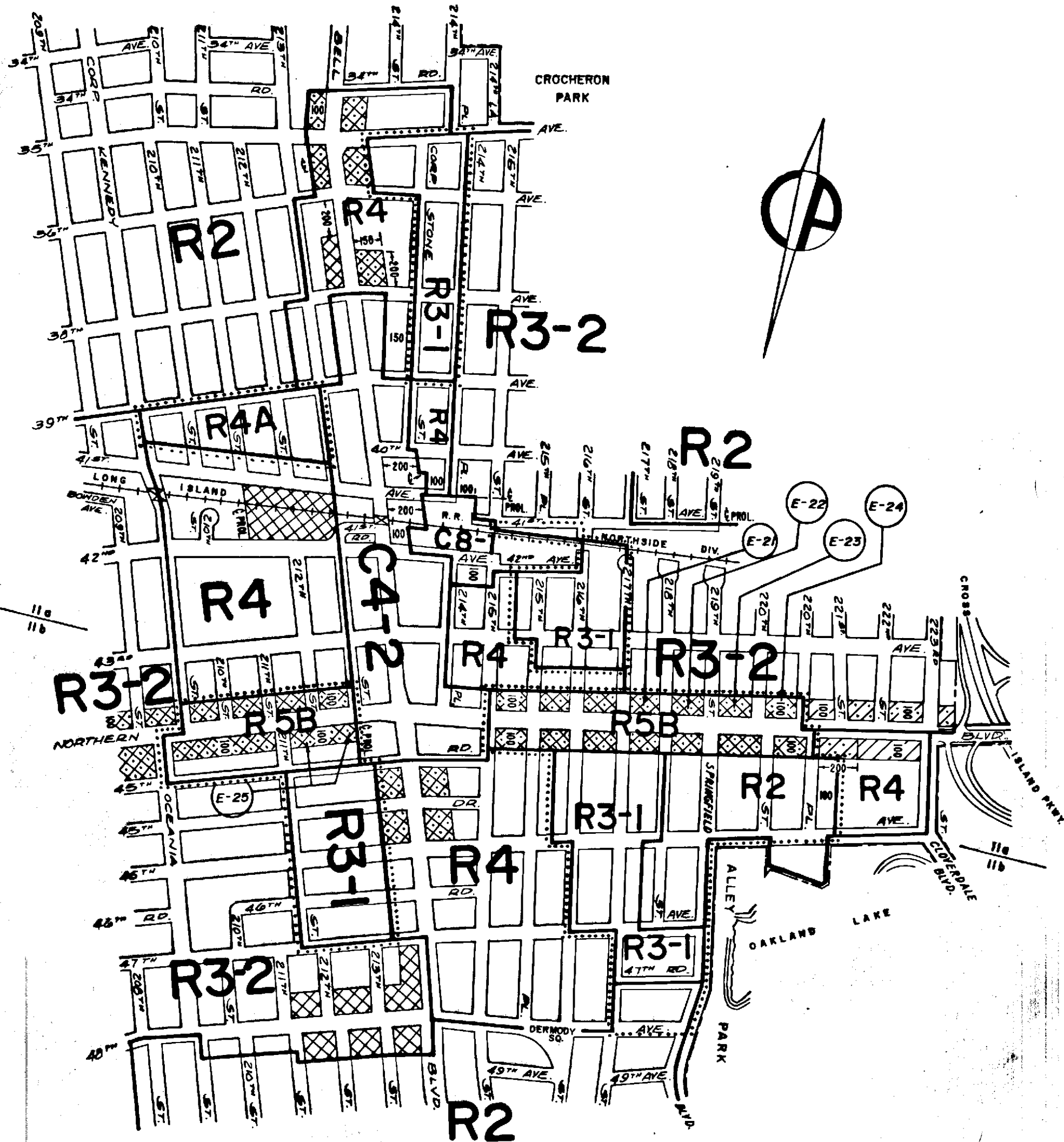

CITY PLANNING COMMISSION  
CITY OF NEW YORK

**DIAGRAM SHOWING PROPOSED  
ZONING CHANGE  
ON SECTIONAL MAPS  
11a & 11b  
BOROUGH OF  
QUEENS**

New York, Certificate Date  
June 5, 1989

*Sam P...*  
Director for Technical Review,  
Land Use Review Division  
*Anthony J. Petrucci, P.E.*  
Chief Engineer



- NOTE:**
- indicates Zoning District boundary.
  - .....** The areas enclosed by the fine dotted lines are proposed to be changed from R4 and C8-1 Districts to R2, R3-1, R3-2, R4A and R5B Districts.
  - ▨** indicates a C1-1 District.
  - ▩** indicates a C1-2 District.
  - ▧** indicates a C2-1 District.
  - ▣** indicates a C2-2 District.
  - (E)** indicates a City Environmental Quality Review Declaration, for detail refer to C.E.Q.R. sheet.



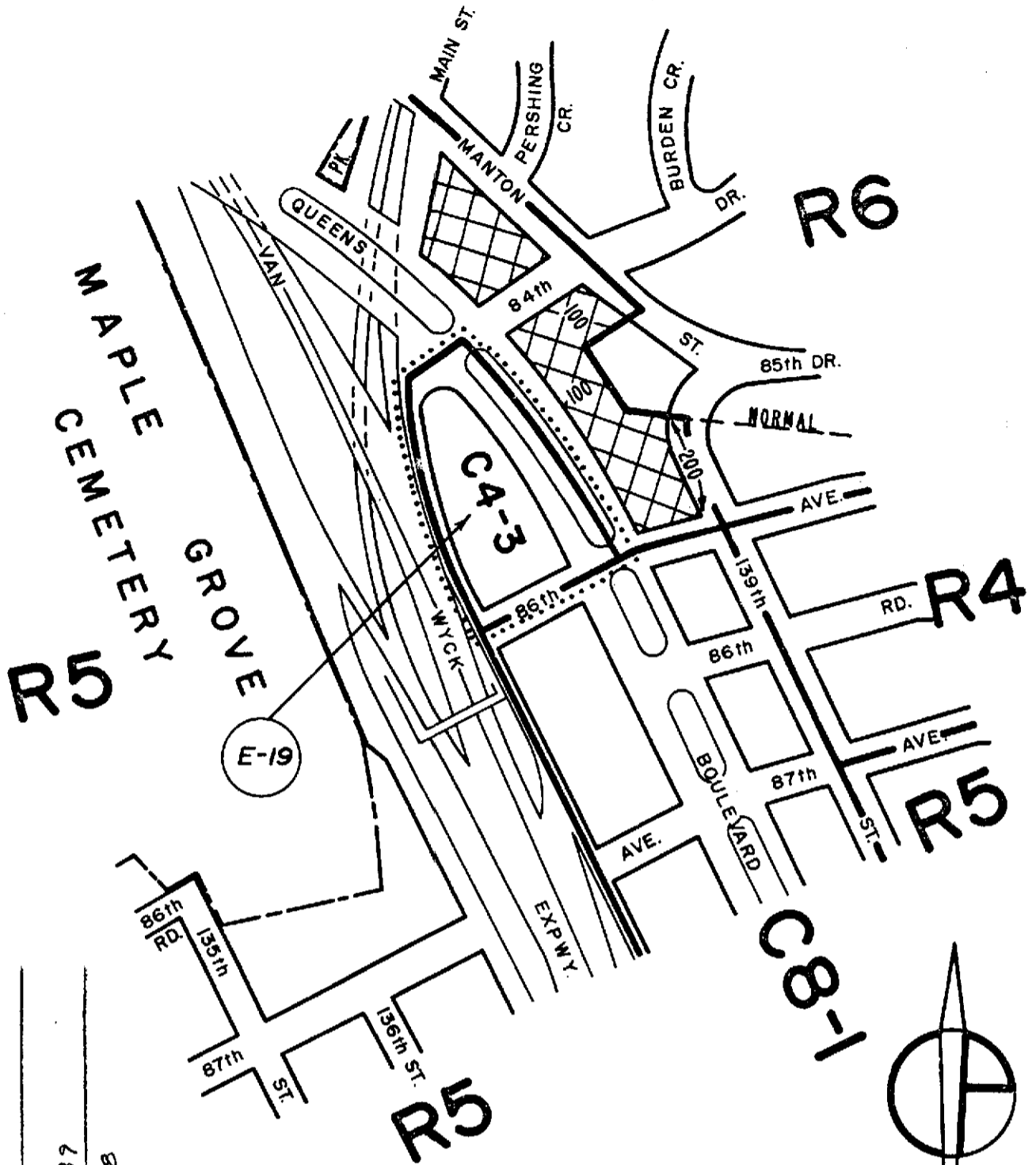

APPROVED BY BOARD OF ESTIMATE

CALENDAR # 51

DATE 9-28-87

A-1548

CITY PLANNING COMMISSION  
CITY OF NEW YORK

DIAGRAM SHOWING PROPOSED  
ZONING CHANGE  
ON SECTIONAL MAP

14d

BOROUGH OF  
QUEENS

*[Signature]*  
Deputy Director for Technical Review,  
Land Use Review Division

*[Signature]* Anthony J. Patrisio, P.E.  
Chief Engineer

New York, Certification Date  
April 17, 1989  
Modified August 21, 1989



NOTE:

- indicates Zoning District boundary.
- The area enclosed by the fine dotted line is proposed to be changed from R5 and C1-2 Districts to a C4-3 District.
- Indicates a C1-2 District.
- indicates a City Environmental Quality Review Declaration, for detail refer to C.E.Q.R. sheet.

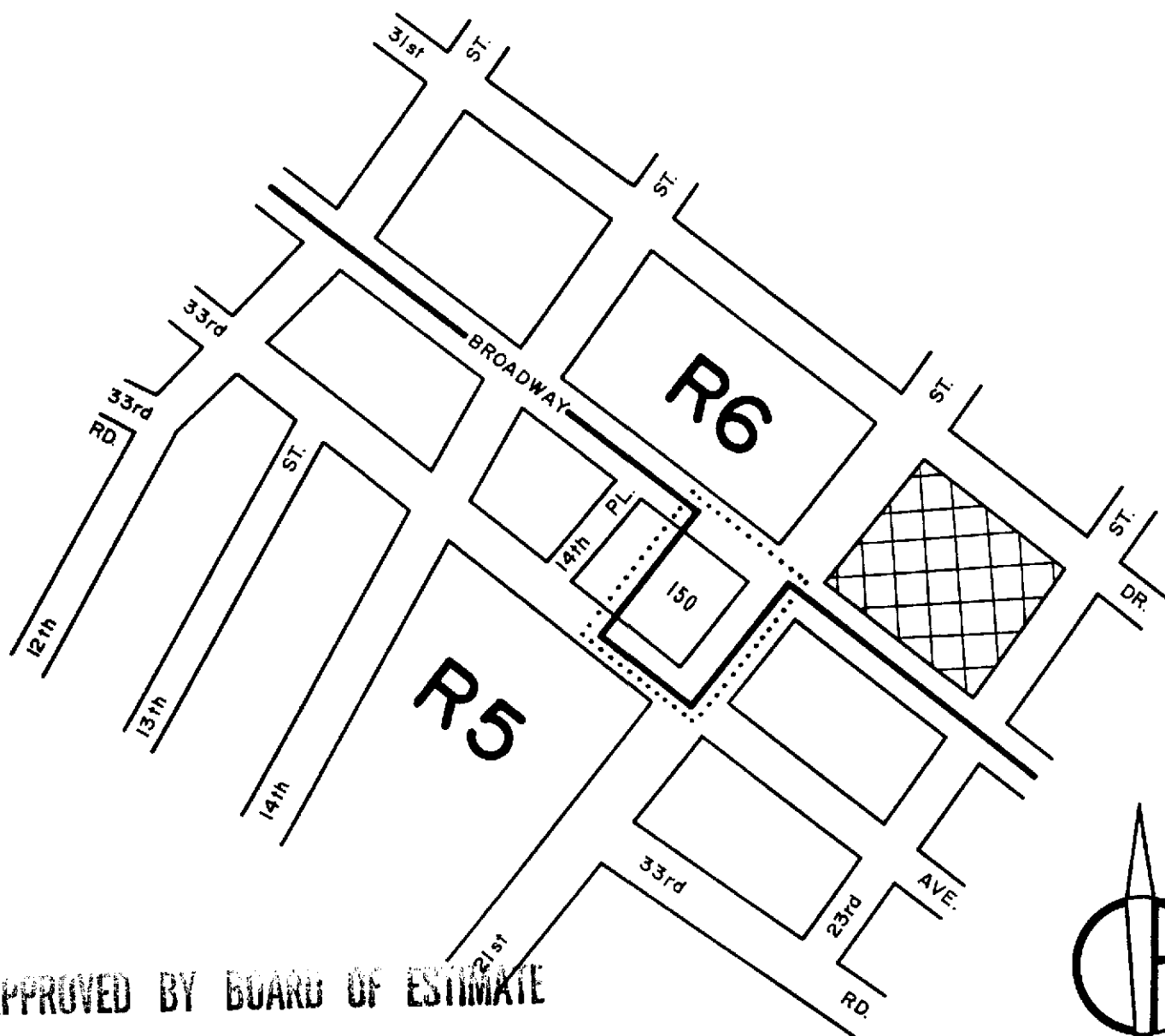

APPROVED BY BOARD OF ESTIMATE

CALENDAR # 37

DATE 10-26-89  
A-1559

CITY PLANNING COMMISSION  
CITY OF NEW YORK

**DIAGRAM SHOWING PROPOSED  
ZONING CHANGE  
ON SECTIONAL MAP  
9a**

BOROUGH OF  
QUEENS

New York, Certification Date  
**June 5, 1989**

*[Signature]*  
Director for Technical Review,  
Land Use Review

*[Signature]* Anthony J. Patricio, P.E.  
Chief Engineer

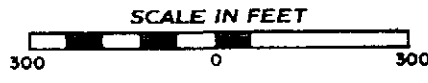

- NOTE:**
- indicates Zoning District boundary.
  - The area enclosed by the fine dotted line is proposed to be changed from an R5 District to an R6 District.
  - indicates a C1-2 District.

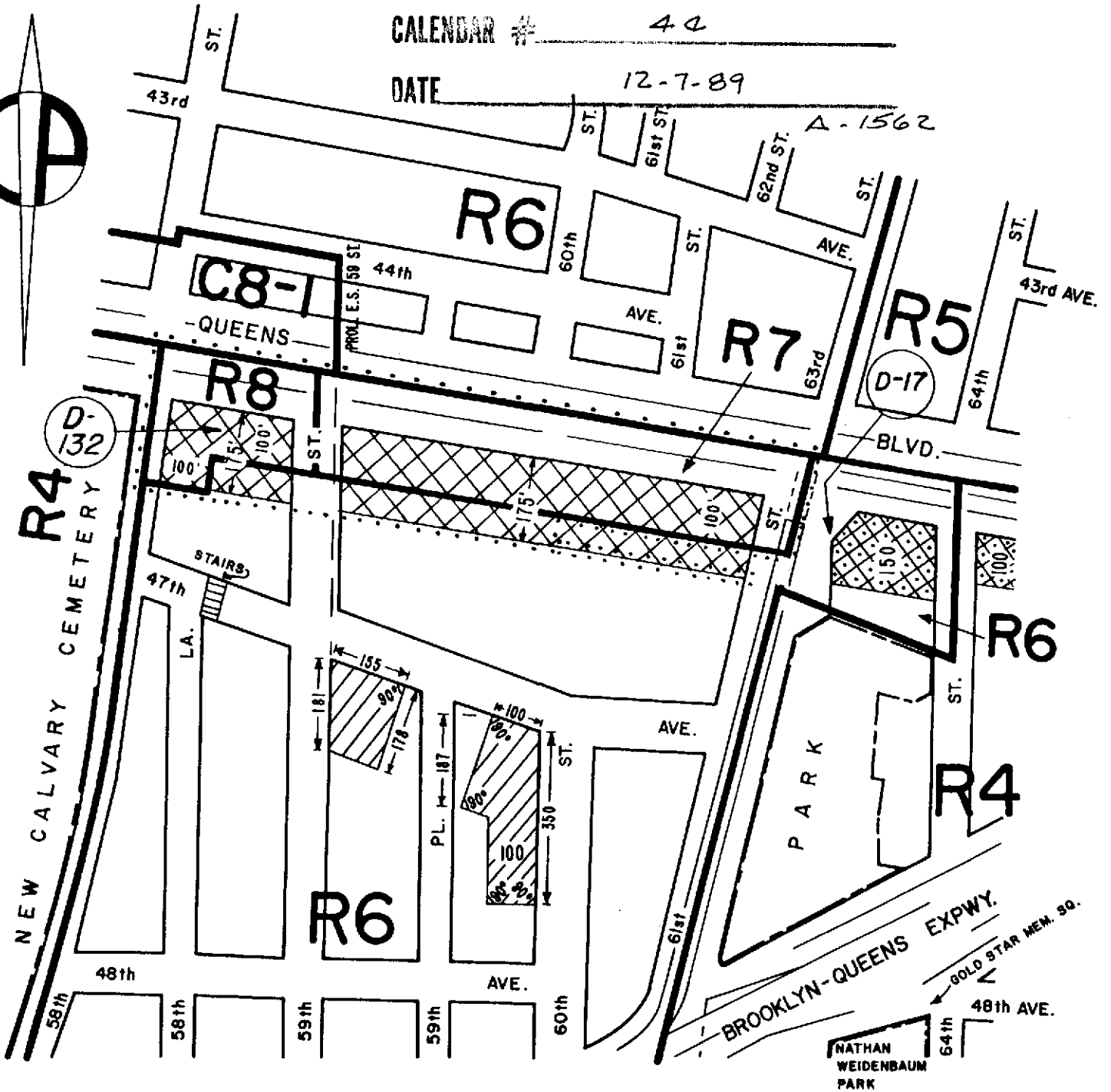

CITY PLANNING COMMISSION  
CITY OF NEW YORK

DIAGRAM SHOWING PROPOSED  
ZONING CHANGE  
ON SECTIONAL MAP

9d

BOROUGH OF  
QUEENS

Director of Technical Review,  
Land Use Review Division

Chief Engineer

New York, Certification Date  
June 26, 1989

Modified November 3, 1989

Modified by Board of Estimate  
December 7, 1989

SCALE IN FEET

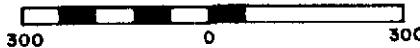

NOTE:

- indicates Zoning District boundary.
- The areas enclosed by the fine dotted lines are proposed to be changed from an R6 District to R8 and R7 Districts and by establishing C1-2 Districts within the proposed R7 and R8 Districts and the existing R6 District.
- indicates a C1-1 District.
- indicates a C1-2 District. indicates a C2-2 District.
- indicates a Restrictive Declaration Area, refer to R.D. sheet.

APPROVED BY BOARD OF ESTIMATE

CALENDAR YEAR 31

DATE 1-25-40

A-1569

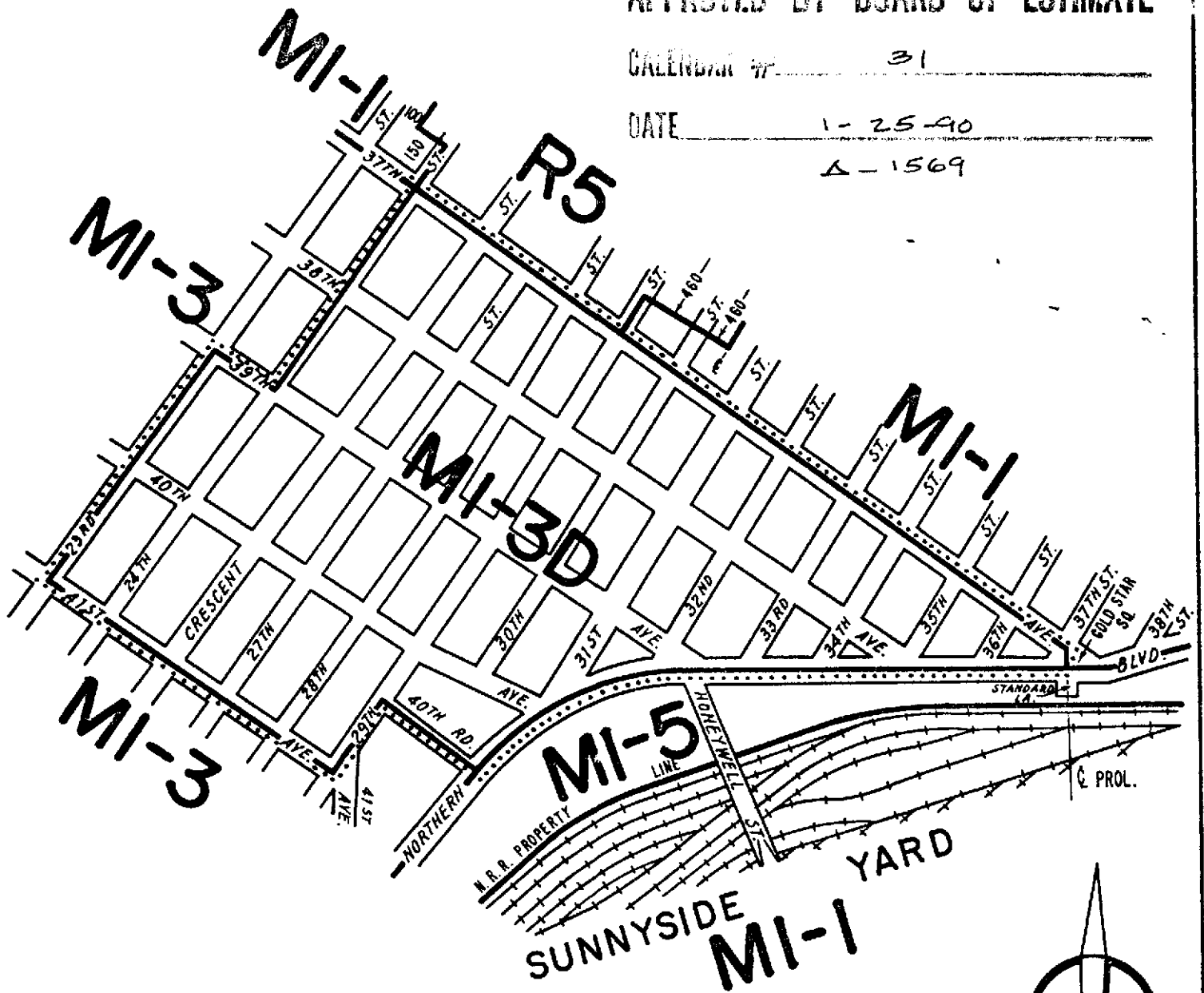

CITY PLANNING COMMISSION  
CITY OF NEW YORK

DIAGRAM SHOWING PROPOSED  
ZONING CHANGE  
ON SECTIONAL MAP

9b

BOROUGH OF  
QUEENS

New York, Certification Date  
October 2, 1989

*[Signature]*  
 Director of Technical Review  
 Land Use Review Division  
*[Signature]*  
 Chief Engineer

SCALE IN FEET



NOTE:

- indicates Zoning District boundary.
- ..... The area enclosed by the fine dotted line is proposed to be changed from an MI-3 District to an MI-3D District.

MI-1

9c | 10a

NEW YORK CITY  
MUNICIPAL AIRPORT  
(LA GUARDIA FIELD)

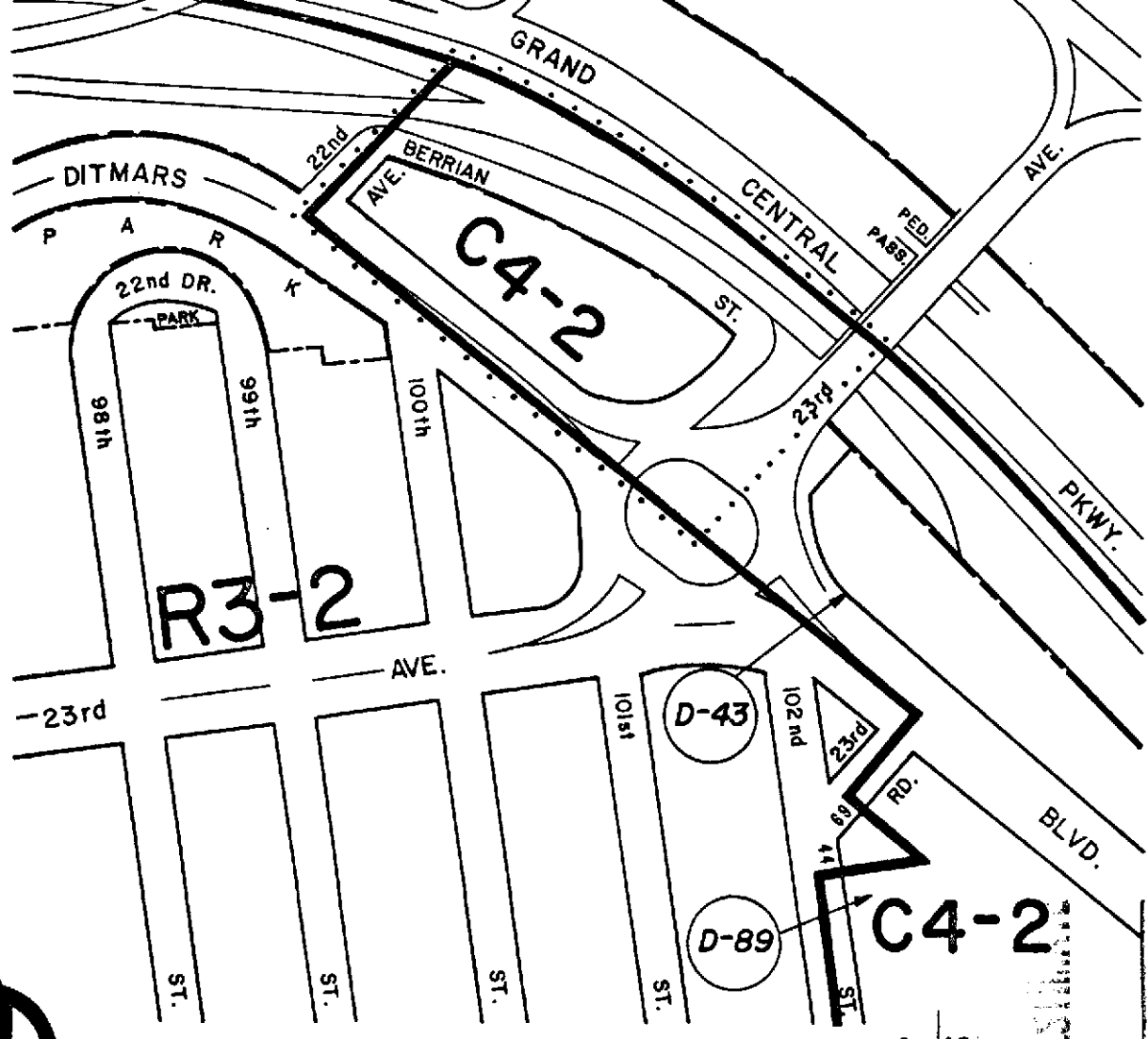

CITY PLANNING COMMISSION  
CITY OF NEW YORK

**DIAGRAM SHOWING PROPOSED  
ZONING CHANGE  
ON SECTIONAL MAP**

9c

BOROUGH OF  
QUEENS

New York; Certification Date  
January 22, 1990



**NOTE:**

- indicates Zoning District boundary.
- .....** The area enclosed by the fine dotted line is proposed to be changed from C2-2 and R3-2 Districts to a C4-2 District.
- (D)** indicates a Restrictive Declaration Area, refer to R.D. sheet.

APPROVED BY BOARD OF ESTIMATES

CALENDAR # 24

DATE 4-26-90

4-1580

*John P. ...*  
Director of Technical Review,  
Land Use Review Division

*Anthony J. ...*  
Chief Engineer

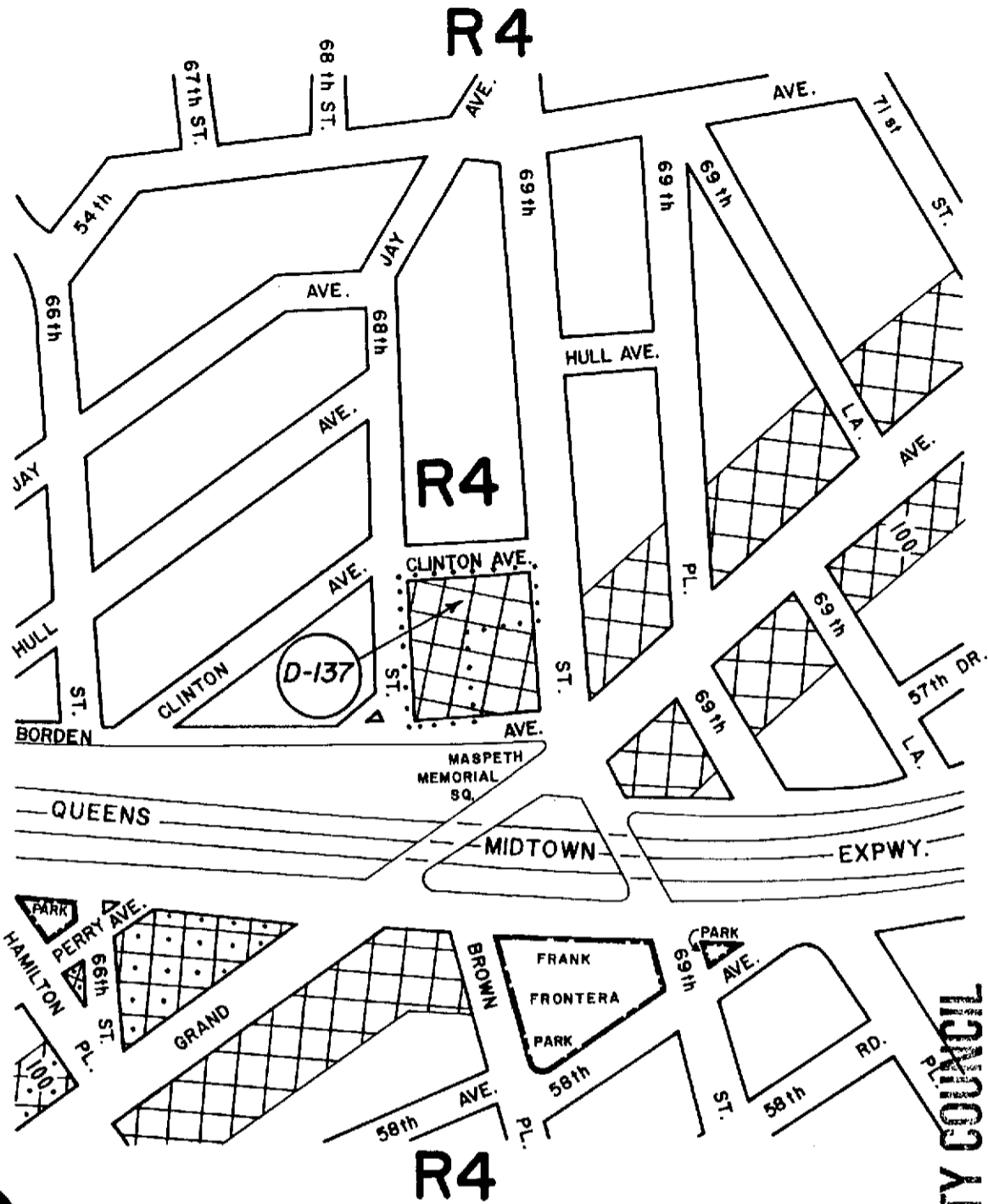

CITY PLANNING COMMISSION  
CITY OF NEW YORK

**DIAGRAM SHOWING PROPOSED  
ZONING CHANGE  
ON SECTIONAL MAP**

13c

BOROUGH OF  
QUEENS

New York, Certification Date  
March 26, 1990



**NOTE:**

- indicates Zoning District boundary.
- The area enclosed by the fine dotted line is proposed to be changed by establishing a C1-2 District within an existing R4 District.
- indicates a C1-2 District.
- indicates a C2-2 District.
- indicates a Restrictive Declaration Area, refer to R.D. sheet.

**APPROVED BY CITY COUNCIL**

CALENDAR # \_\_\_\_\_

DATE 10-10-90  
A-1592

*[Signature]*  
Director of Technical Review,  
Land Use Review Division  
*[Signature]*  
Chief Engineer

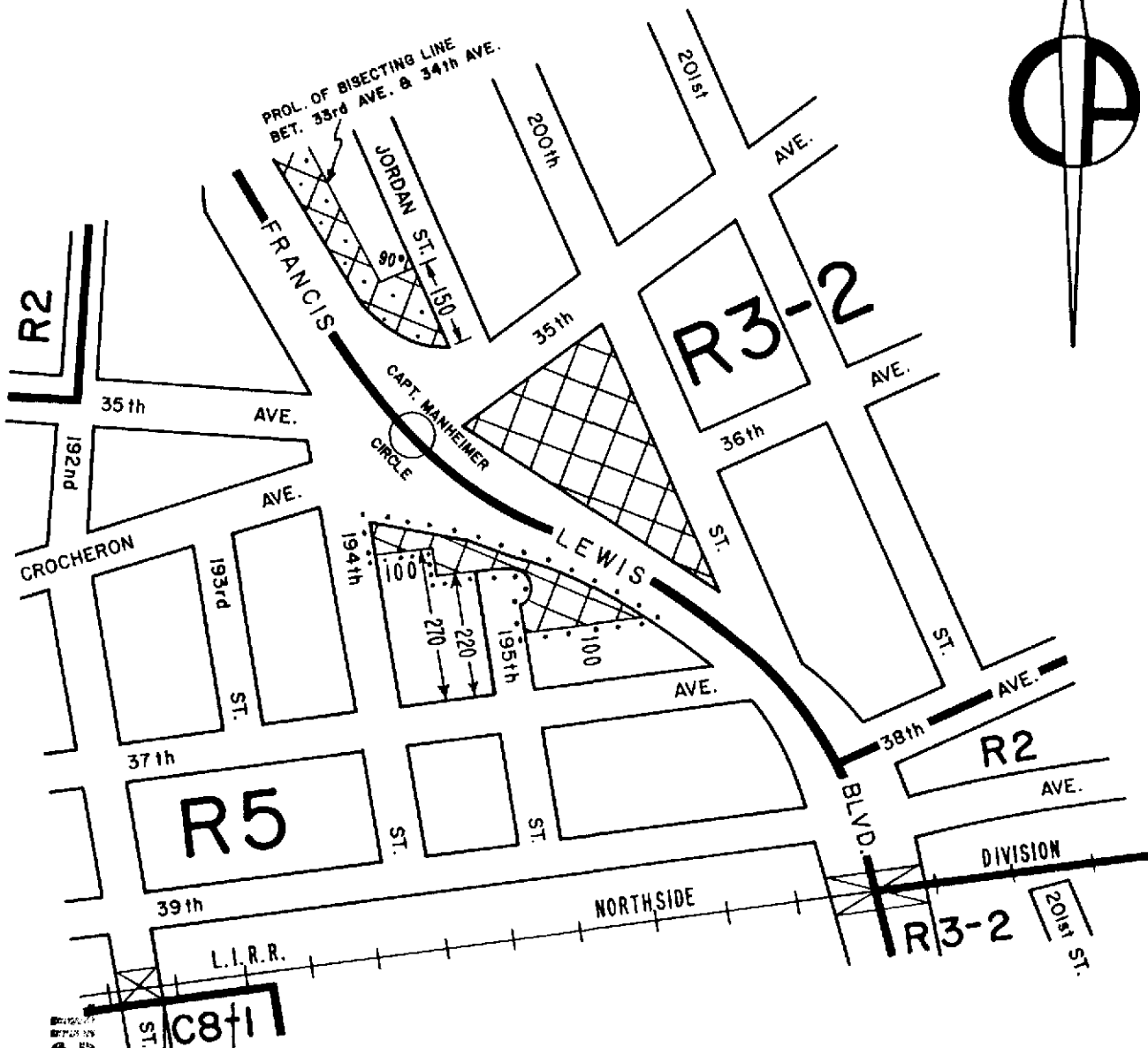

NOTE:  
 REFER TO ALTERATION MAP NO. 4848  
 FOR RELATED MAP CHANGE,  
 U.L.U.R.P. NO. C 880391 MMQ

**APPROVED BY CITY COUNCIL**

CALENDAR # 16  
 DATE 12-5-90  
 4-15-99

**CITY PLANNING COMMISSION  
 CITY OF NEW YORK**  
**DIAGRAM SHOWING PROPOSED  
 ZONING CHANGE  
 ON SECTIONAL MAP  
 10c  
 BOROUGH OF  
 QUEENS**

New York, Certification Date  
**June 25, 1990**  
 Modified October 24, 1990

*San P...*  
 Director of Technical Review,  
 Land Use Review Division  
*Anthony J. Patrici, P.E.*  
 Chief Engineer

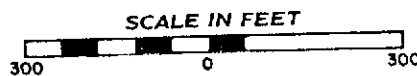

- NOTE:**
- indicates Zoning District boundary.
  - The area enclosed by the fine dotted line is proposed to be changed by establishing a C1-2 District within an existing R5 District.
  - indicates a C1-2 District.
  - indicates a C2-2 District.

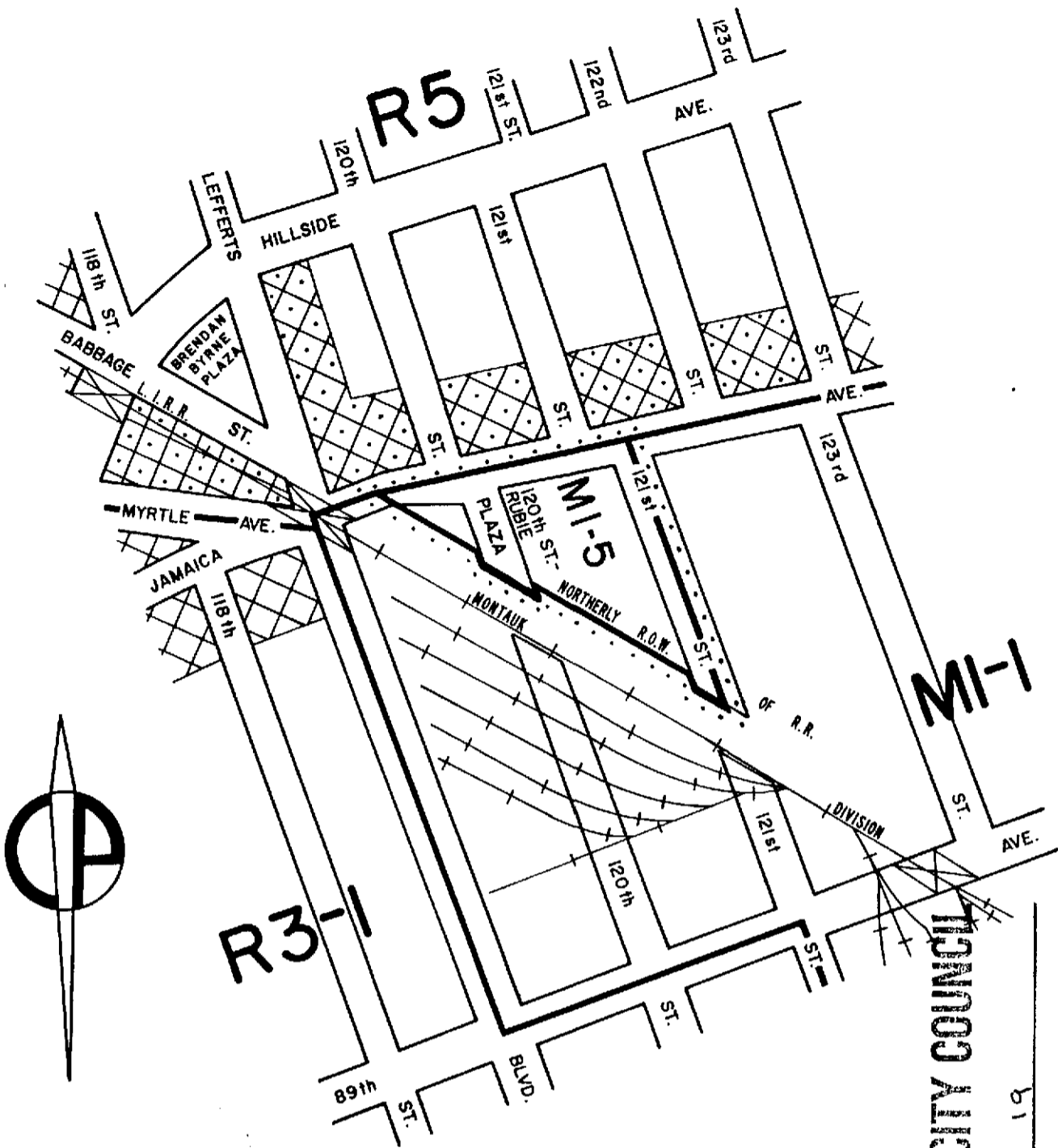

R3-1

R5

MI-5

MI-1

CITY PLANNING COMMISSION  
CITY OF NEW YORK



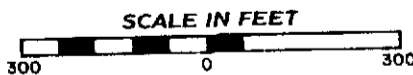

DIAGRAM SHOWING PROPOSED  
ZONING CHANGE  
ON SECTIONAL MAP

14b  
BOROUGH OF  
QUEENS

New York, Certification Date  
July 23, 1990  
Modified October 24, 1990



NOTE:

-  indicates Zoning District boundary.
-  The area enclosed by the fine dotted line is proposed to be changed from an MI-1 District to an MI-5 District.
-  indicates a C1-2 District.
-  indicates a C2-2 District.

APPROVED BY CITY COUNCIL

CALENDAR # 19

DATE 12-20-90

A-1601

  
 Director of Technical Review,  
 Land Use Review Division

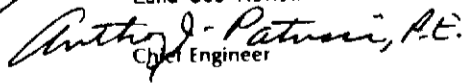
  
 Chief Engineer



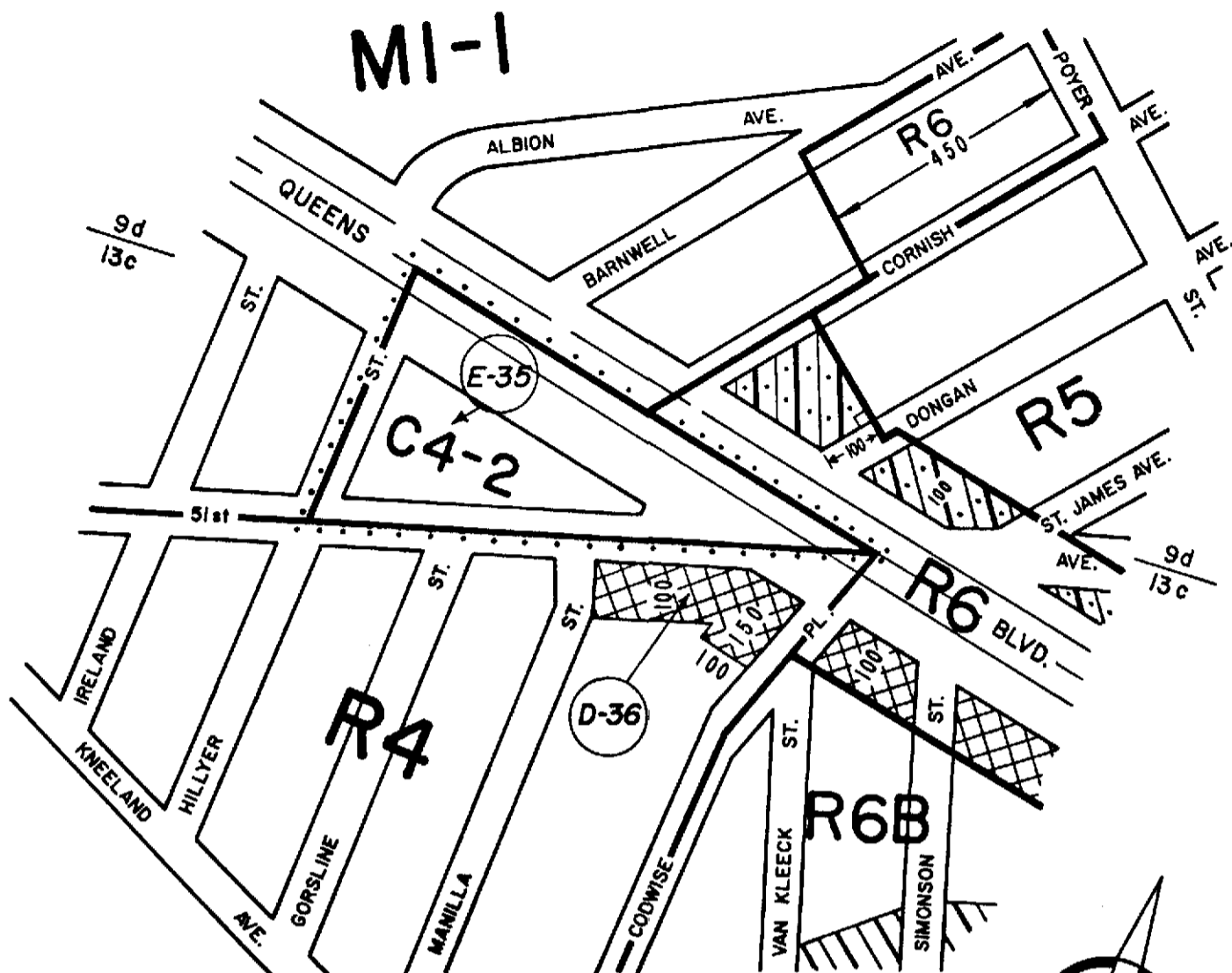

**APPROVED BY CITY COUNCIL**

CALENDAR # 238

DATE 7-30-91

A-1613

**CITY PLANNING COMMISSION  
CITY OF NEW YORK**

**DIAGRAM SHOWING PROPOSED  
ZONING CHANGE  
ON SECTIONAL MAPS**

**9d & 13c  
BOROUGH OF  
QUEENS**

New York, Certification Date  
**March 4, 1991**

*Samuel P. Russo*  
 Director of Technical Review,  
 Land Use Review Division

*Anthony J. Patrucco, P.E.*  
 Chief Engineer

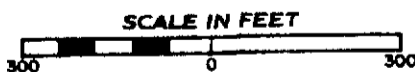

**NOTE:**

- indicates Zoning District boundary.
- The area enclosed by the fine dotted line is proposed to be changed from C2-2 and R4 Districts to a C4-2 District.
- indicates a C1-2 District.
- indicates a C1-3 District. indicates a C2-3 District.
- indicates a City Environmental Quality Review Declaration, refer to C.E.Q.R. sheet.
- indicates a Restrictive Declaration Area, for detail refer to R.D. sheet.

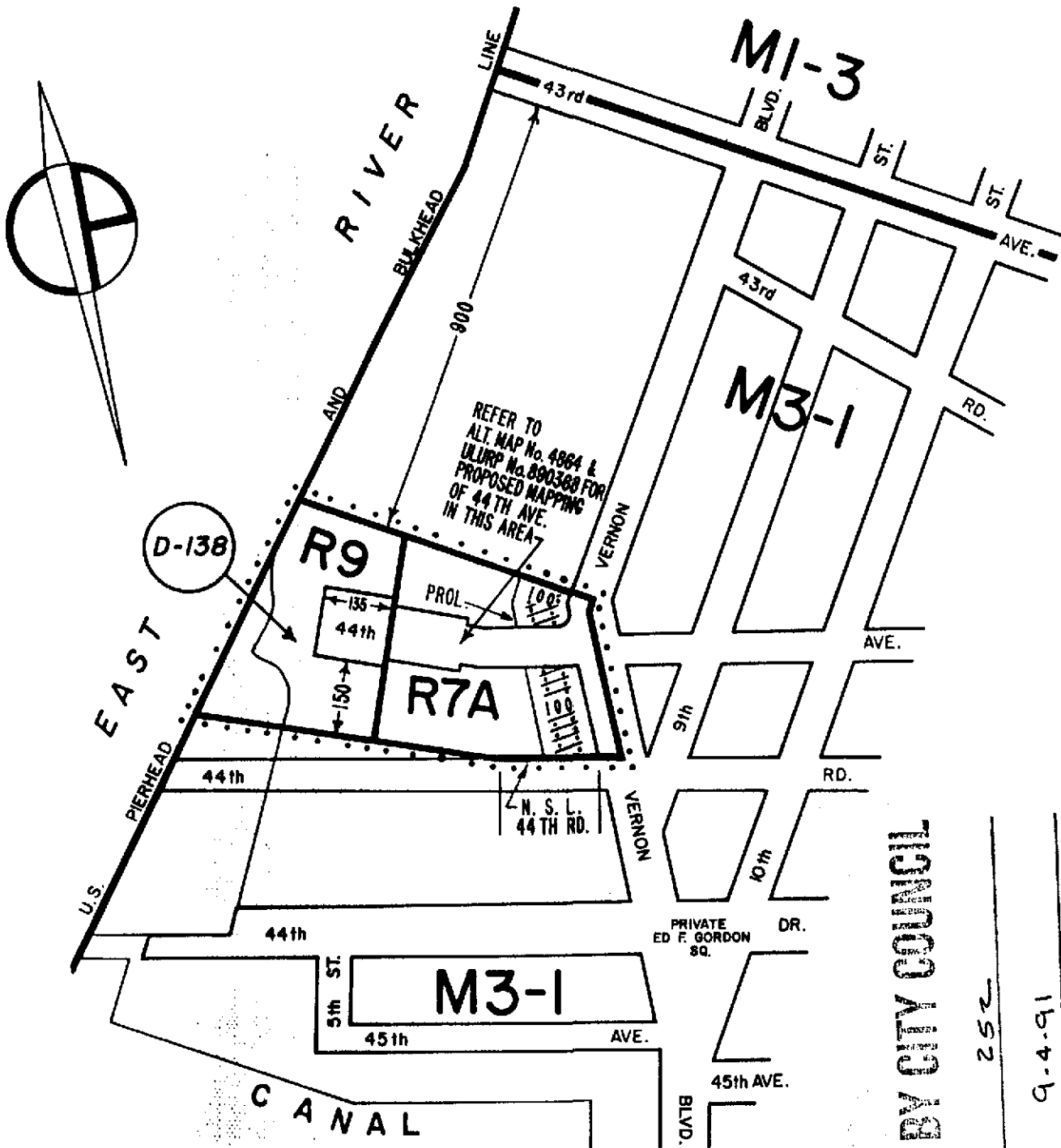

CITY PLANNING COMMISSION  
CITY OF NEW YORK

DIAGRAM SHOWING PROPOSED  
ZONING CHANGE  
ON SECTIONAL MAP  
9b

BOROUGH OF  
QUEENS

New York, Certification Date  
February 19, 1991

Director of Technical Review,  
Land Use Review Division

Anthony J. Patrisio, P.E.  
Chief Engineer



NOTE:

- indicates Zoning District boundary.
- The area enclosed by the fine dotted line is proposed to be changed from an M3-1 District to R7A and R9 Districts and by establishing a C2-5 District within the proposed R7A District.
- indicates a C2-5 District.
- indicates a Restrictive Declaration Area, refer to R.D. sheet.

APPROVED BY CITY COUNCIL

CALENDAR # 252

DATE 9-4-91

A-1618

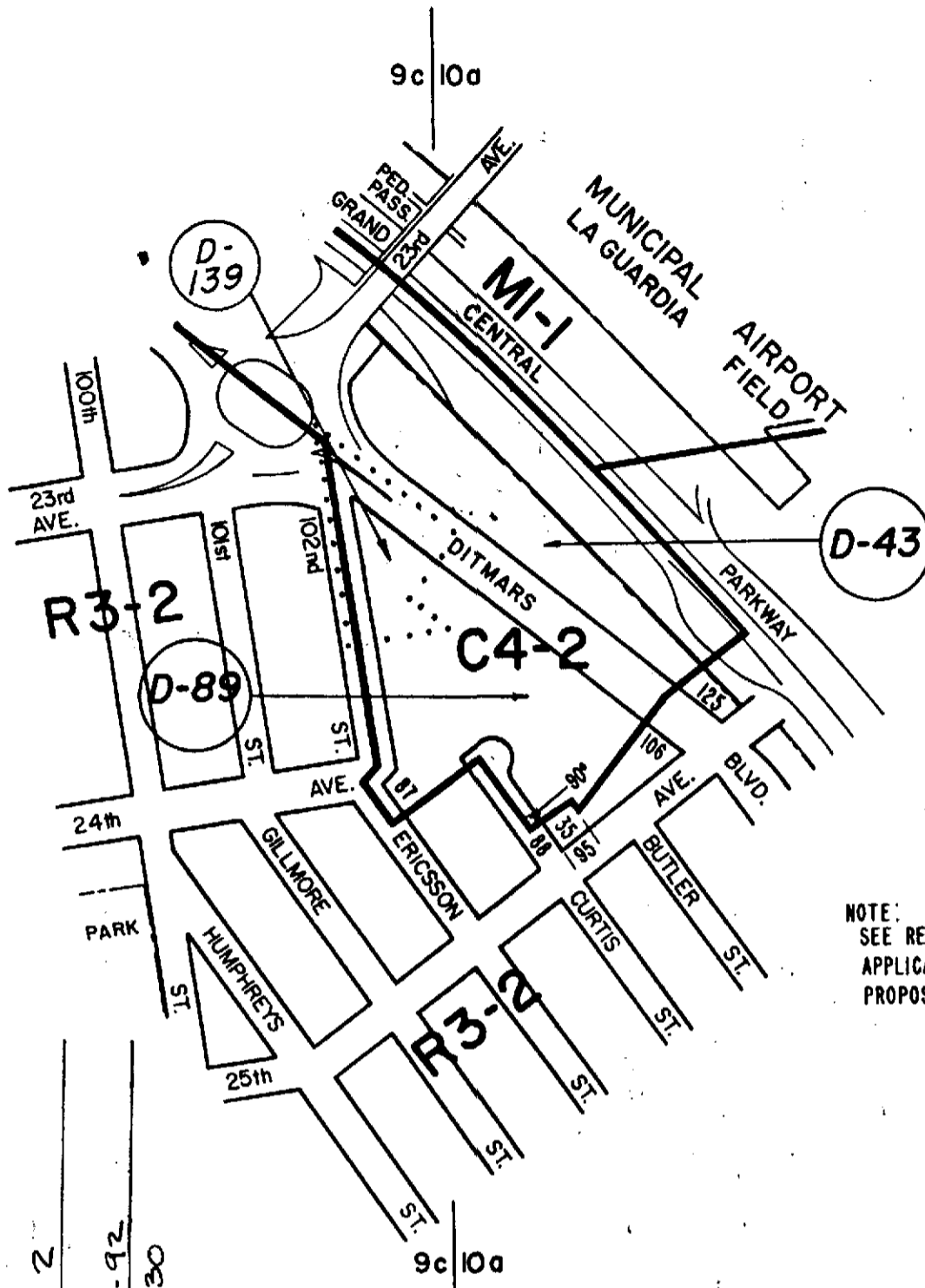

NOTE:  
 SEE RELATED MAPPING  
 APPLICATION C880212 MMQ FOR  
 PROPOSED ELIMINATION OF 23RD RD.

**APPROVED BY CITY COUNCIL**

CALENDAR # 2

DATE 2-11-92

4-1630

CITY PLANNING COMMISSION  
 CITY OF NEW YORK

**DIAGRAM SHOWING PROPOSED  
 ZONING CHANGE  
 ON SECTIONAL MAP  
 9c  
 BOROUGH OF  
 QUEENS**

New York, Certification Date  
 August 12, 1991

*Francis P. Paves*  
 Director for Technical  
 Review, Land Use Review Division  
*Anthony J. Patino, P.E.*  
 Chief Engineer

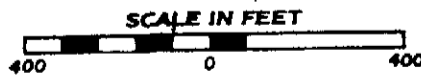

**NOTE:**

- indicates Zoning District boundary.
- .....** The area enclosed by the fine dotted line is proposed to be changed from an R3-2 District to a C4-2 District
- (D)** indicates a Restrictive Declaration Area.

APPROVED BY CITY COUNCIL

CALENDAR # 1667

DATE 10-25-93

Date Mapped 1-17-94

A-1663

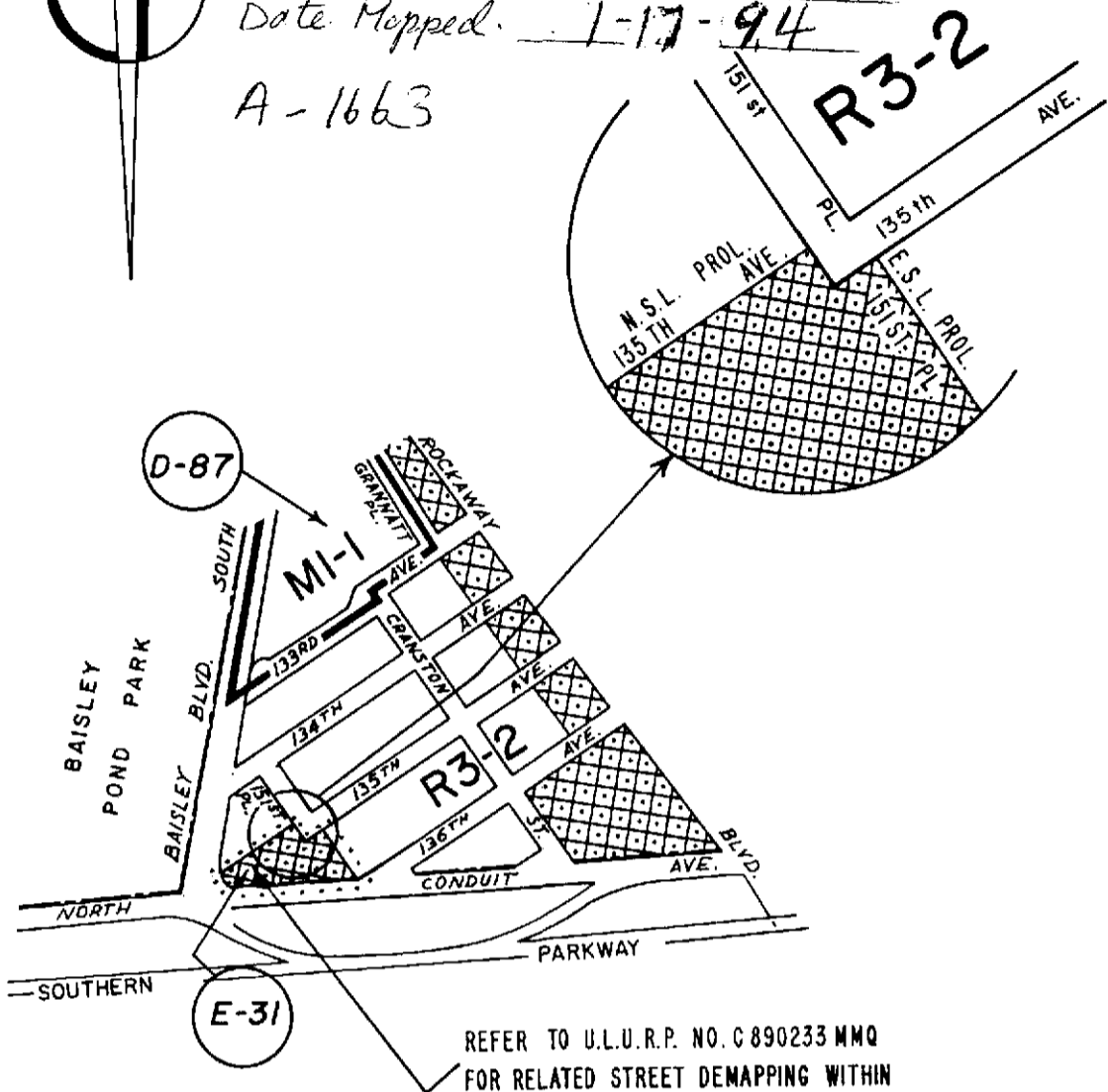
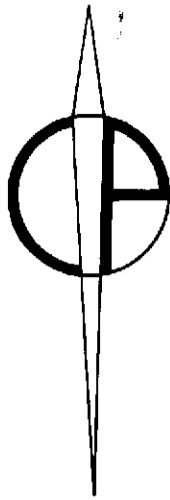

REFER TO U.L.U.R.P. NO. C890233 MMQ FOR RELATED STREET DEMAPPING WITHIN THE AREA OF THIS PROPOSED ZONING CHANGE.

CITY PLANNING COMMISSION  
CITY OF NEW YORK

DIAGRAM SHOWING PROPOSED  
ZONING CHANGE  
ON SECTIONAL MAP

18d  
BOROUGH OF  
QUEENS

New York, Certification Date  
March 29, 1993

*[Signature]*  
Director of Technical Review,  
Land Use Review Division



NOTE:

- indicates Zoning District boundary.
  - The area enclosed by the fine dotted line is proposed to be changed by establishing a C2-2 District within an existing R3-2 District.
  - indicates a C2-2 District.
  - indicates a Restrictive Declaration Area, refer to R.D. sheet.
  - indicates a City Environmental Quality Review Declaration, refer to C.E.Q.R. sheet.
- THIS DIAGRAM IS FOR ILLUSTRATIVE PURPOSES ONLY.

Drawn By: *[Signature]*

APPROVED BY BOARD OF ESTIMATE

DATE 1-25-90

DATE 4-15-70

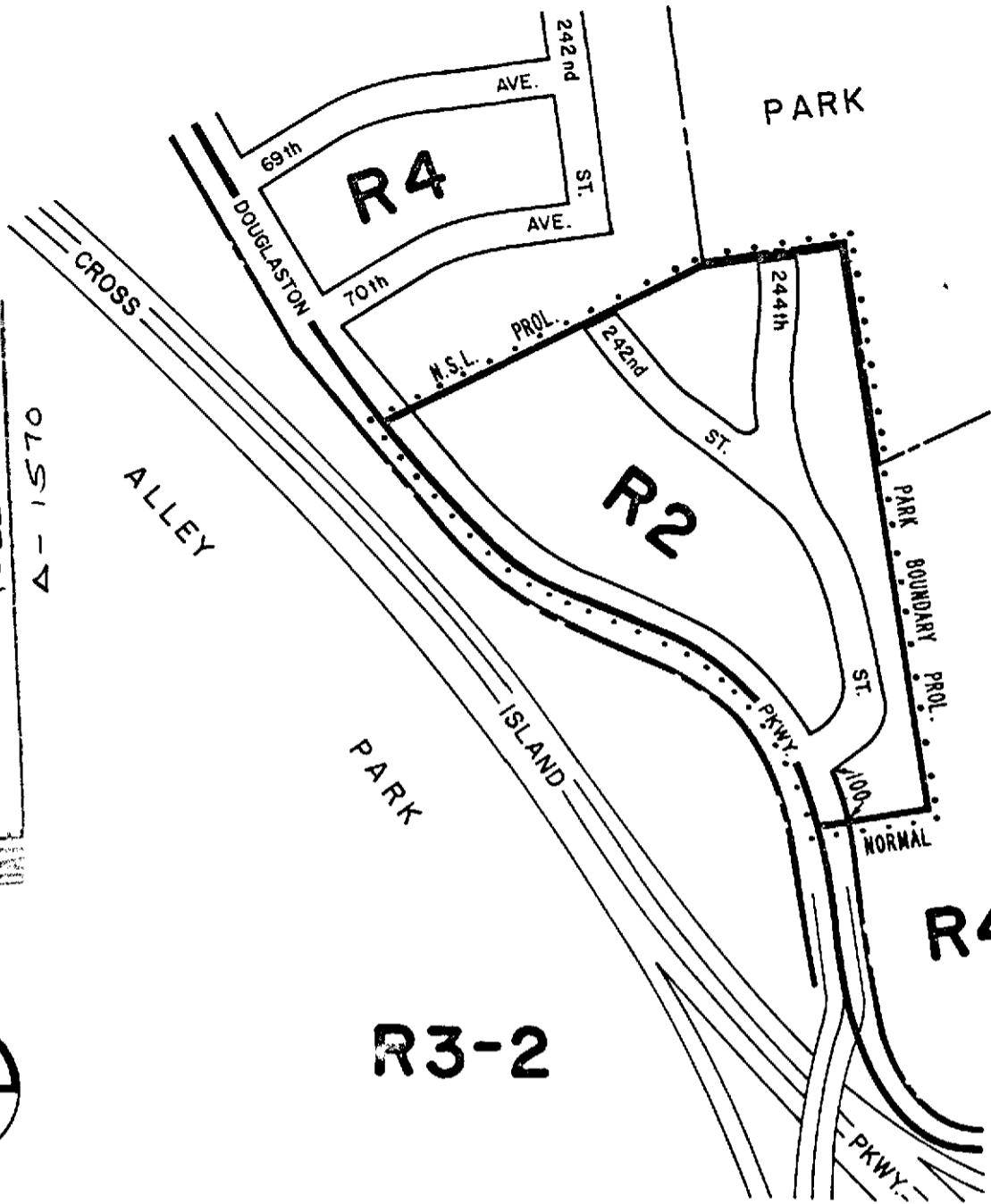
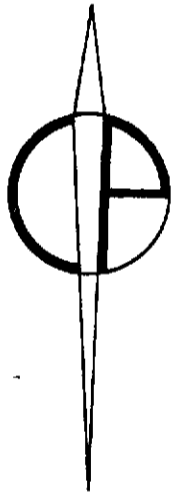

CITY PLANNING COMMISSION  
CITY OF NEW YORK

**DIAGRAM SHOWING PROPOSED  
ZONING CHANGE  
ON SECTIONAL MAP**

11b

BOROUGH OF  
QUEENS

New York, Certification Date  
October 2, 1989

*Alan P. P...*  
 Director of Technical Review,  
 Land Use Review Division

*Anthony J. Paterni, P.E.*  
 Chief Engineer

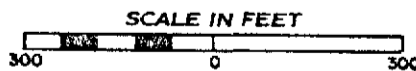

**NOTE:**

- indicates Zoning District boundary.
- .....** The area enclosed by the fine dotted line is proposed to be changed from an R4 District to an R2 District.

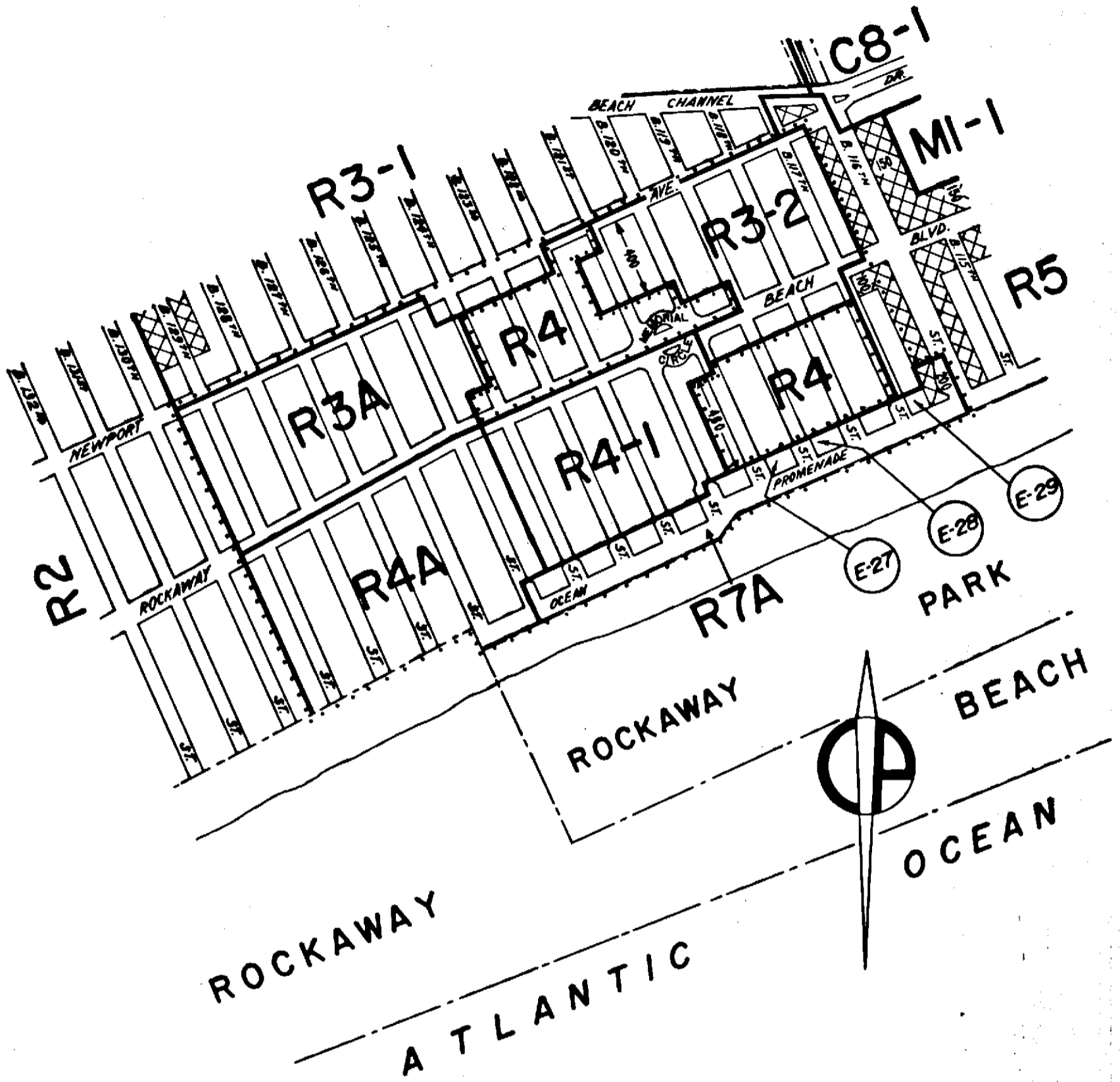

CITY PLANNING COMMISSION  
CITY OF NEW YORK

DIAGRAM SHOWING PROPOSED  
ZONING CHANGE  
ON SECTIONAL MAP  
30b  
BOROUGH OF  
QUEENS

New York, Certification Date  
June 26, 1989

*Luca P. P...*  
Director for Technical Review,  
Land Use Review Division

*Anthony J. Patrisi, P.E.*  
Chief Engineer



- NOTE:**
- indicates Zoning District boundary.
  - ..... The areas enclosed by the fine dotted lines are proposed to be changed from R4 and R5 Districts to R3-1, R3-2, R3A, R4-1, R4A, R5 and R7A Districts.
  - ▨ indicates a CI-2 District.
  - ⓔ indicates a City Environmental Quality Review Declaration, for detail refer to C.E.Q.R. sheet.

*J. P. P...*



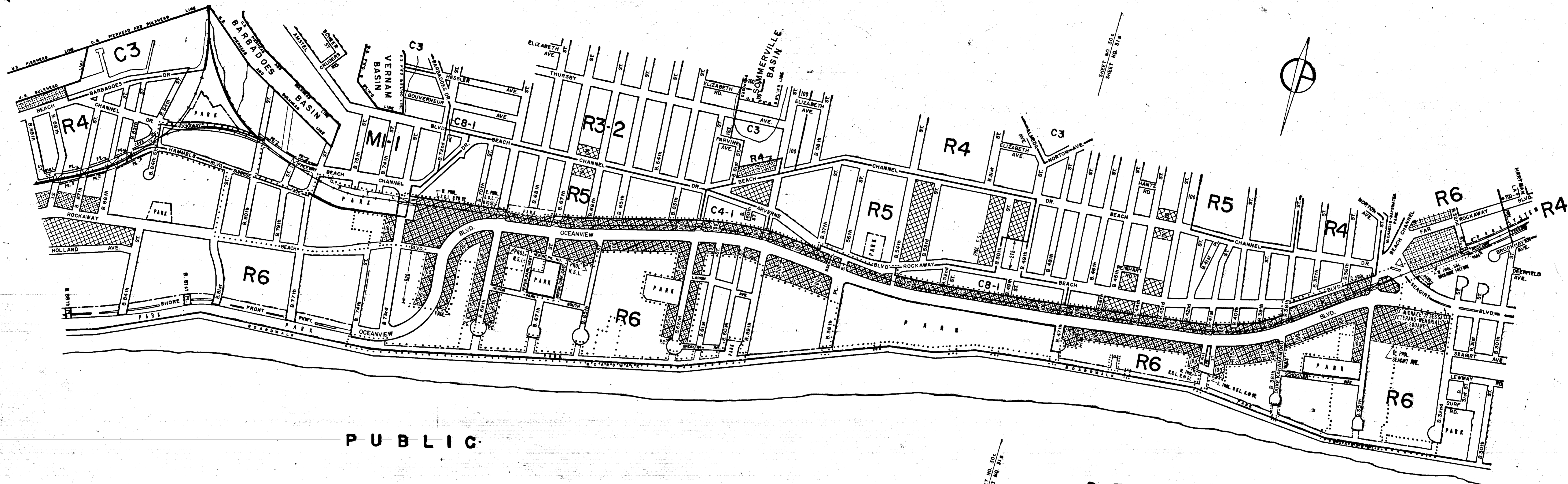

PUBLIC

BEACH

PROPOSED

U.S.

PIERHEAD

AND

BULKHEAD

LINE

A T L A N T I C

O C E A N

CITY PLANNING COMMISSION  
CITY OF NEW YORK  
DIAGRAM SHOWING PROPOSED  
ZONING CHANGE  
ON SECTIONAL MAPS  
30 & 31,  
BOROUGH OF  
QUEENS

*Allen Purns*  
Director of Technical Services, Land Use Review Division  
*Anthony J. Pata*, P.E.  
City Engineer

New York, Certification Date  
February 13, 1990



NOTE:

- indicates Zoning District boundary.
- ..... The area enclosed by the fine dotted line is proposed to be changed from Parkland, C1-2, C2-2, R4, R5, R6, C4-1 and C8-1 Districts to Parkland, R6 and MI-1 Districts; by establishing C2-2 and C2-4 Districts within the existing and the proposed R6 District.
- ▨ indicates a C1-2 District.
- ▩ indicates a C2-2 District.
- ▧ indicates a C2-4 District.

NOTE:

THIS DRAWING REFLECTS PROPOSED CHANGES IN THE CITY MAP  
PURSUANT TO RELATED MAPPING APPLICATION C900151 MMQ.

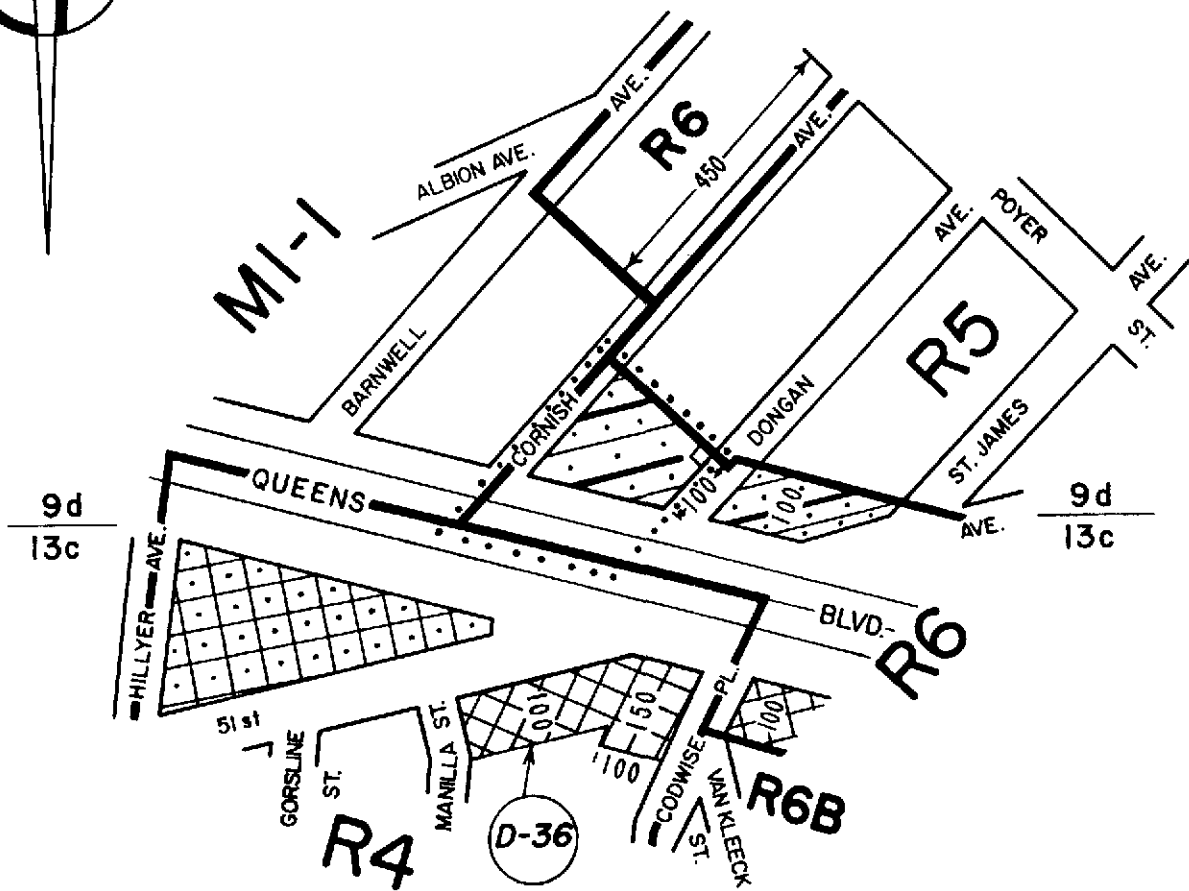

**APPROVED BY CITY COUNCIL**

CALENDAR # 7

DATE 10-25-90  
A-1597

CITY PLANNING COMMISSION  
CITY OF NEW YORK

**DIAGRAM SHOWING PROPOSED  
ZONING CHANGE  
ON SECTIONAL MAPS**

**9d & 13c  
BOROUGH OF  
QUEENS**

New York, Certification Date  
May 7, 1990

*Blawie*  
Director of Technical Review,  
Land Use Review Division

*Anthony J. Patrucco, P.E.*  
Chief Engineer

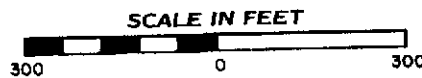

**NOTE:**

- indicates Zoning District boundary.
- The area enclosed by the fine dotted line is proposed to be changed from MI-1 and R5 Districts to R5 and R6 Districts and by establishing a C2-3 District within the proposed R6 District.
- indicates a C1-2 District.
- indicates a C2-2 District.
- indicates a C2-3 District.
- Indicates a Restrictive Declaration Area, refer to R.D. sheet.



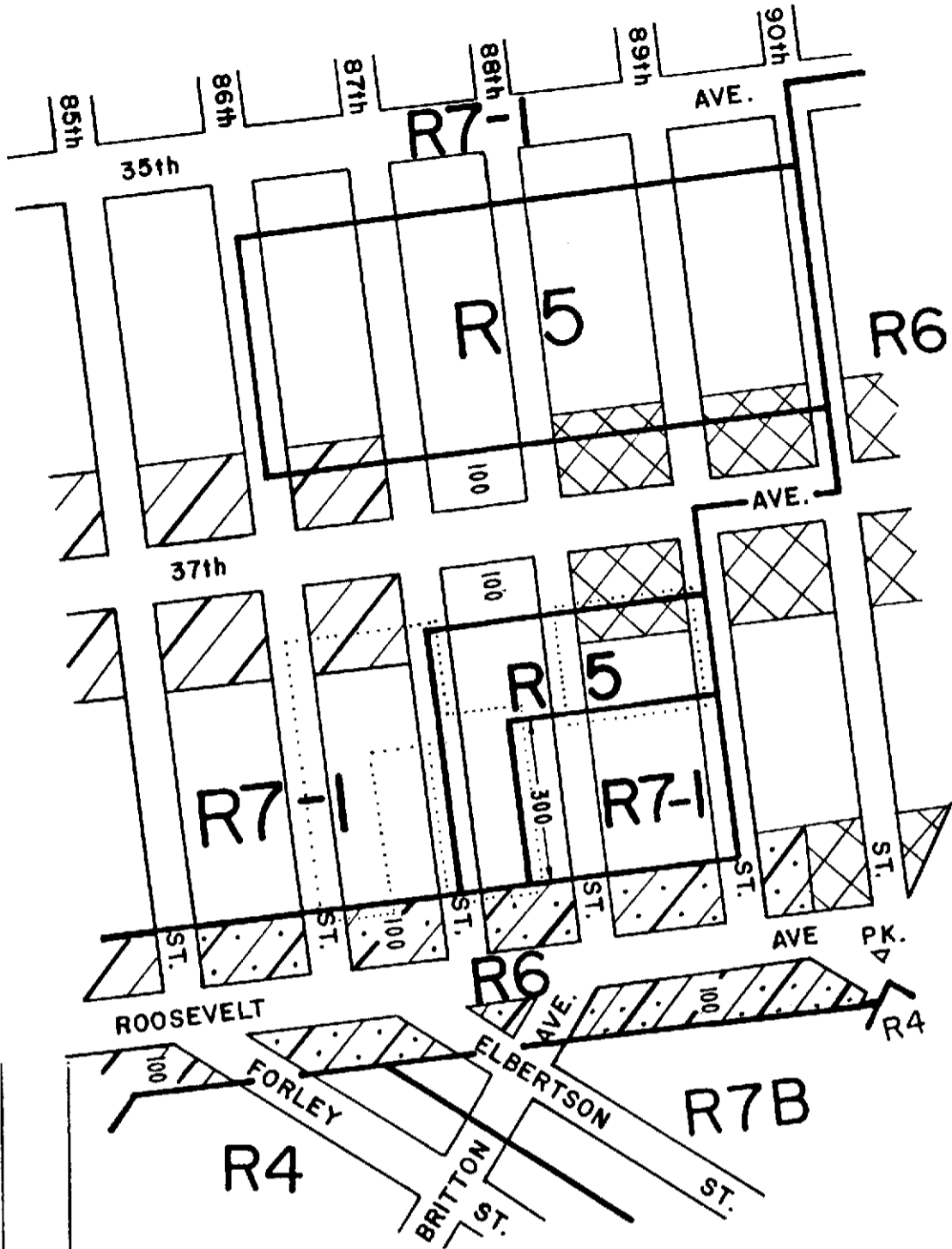

APPROVED BY CITY COUNCIL

CALENDAR # 64

DATE 12-5-90

4-1600

CITY PLANNING COMMISSION  
CITY OF NEW YORK

DIAGRAM SHOWING PROPOSED  
ZONING CHANGE  
ON SECTIONAL MAP

9d  
BOROUGH OF  
QUEENS

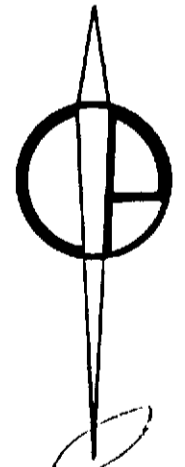

*Sam Parnis*  
Director of Technical Review  
Land Use Review Division

*Anthony J. Patrusi, P.E.*  
Chief Engineer

New York, Certification Date  
June 25, 1990

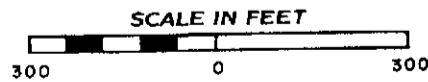

NOTE:

- indicates Zoning District boundary.
- The areas enclosed by the fine dotted lines are proposed to be changed from R7-1 and R5 Districts to R5 and R7-1 Districts.
- indicates a C1-2 District.
- indicates a C1-3 District.
- indicates a C2-2 District.
- indicates a C2-3 District.

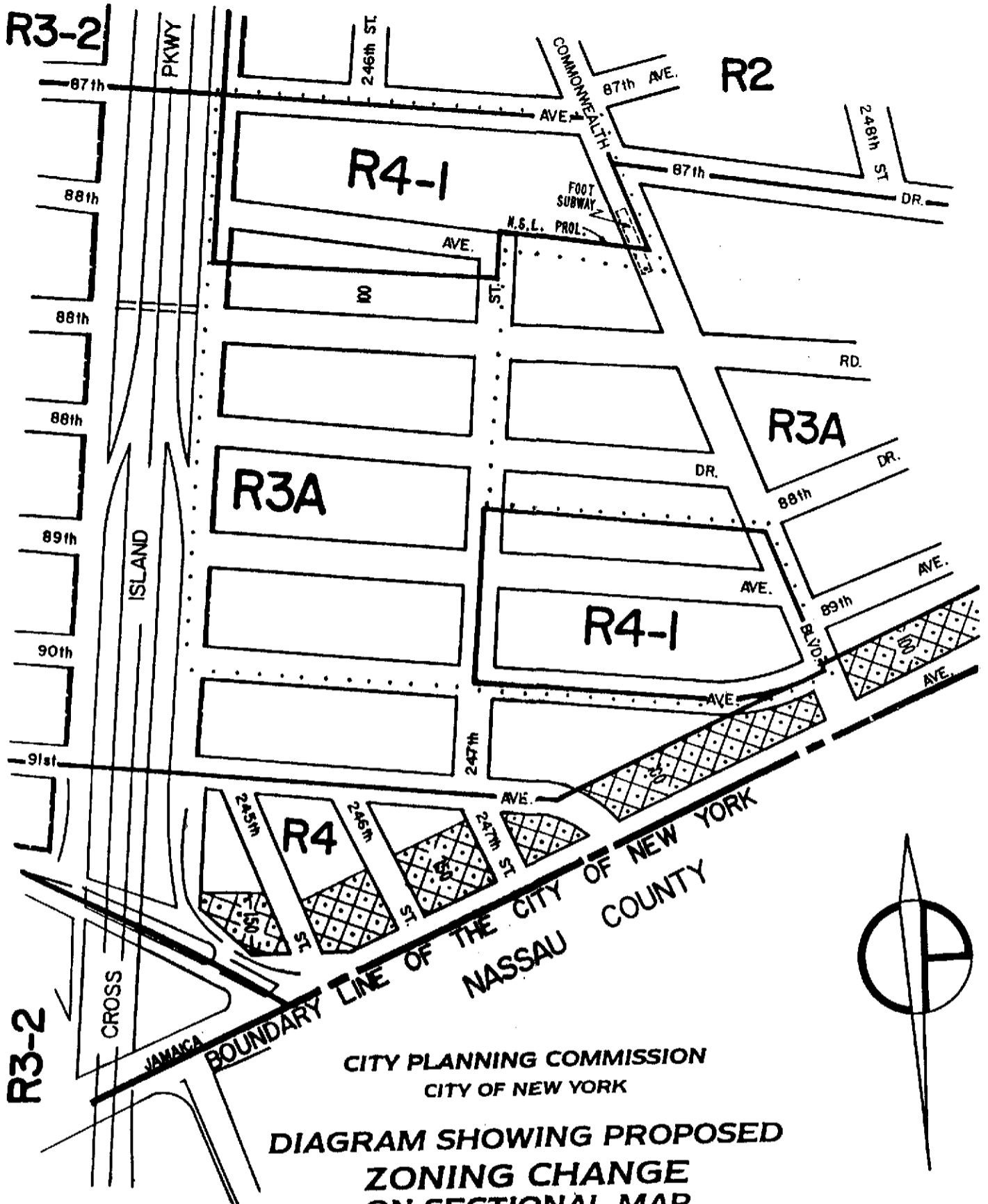

**CITY PLANNING COMMISSION  
CITY OF NEW YORK**

**DIAGRAM SHOWING PROPOSED  
ZONING CHANGE  
ON SECTIONAL MAP**

**15C  
BOROUGH OF  
QUEENS**

New York Certification Date  
*March 4, 1991.*

*San Parnes*  
Director of Technical Review  
Land Use Review Division  
P.E.  
Acting Chief Engineer

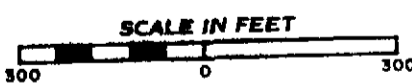

- NOTE:**
- Indicates Zoning District boundary.
  - The area enclosed by the fine dotted line is proposed to be changed from an R4 District to an R4-1 District and an R3A District.
  - Indicates a C2-2 District.

**APPROVED BY CITY COUNCIL**

CALENDAR # 262

DATE 8-15-91

Drawn By: *PK*

*D-1615*

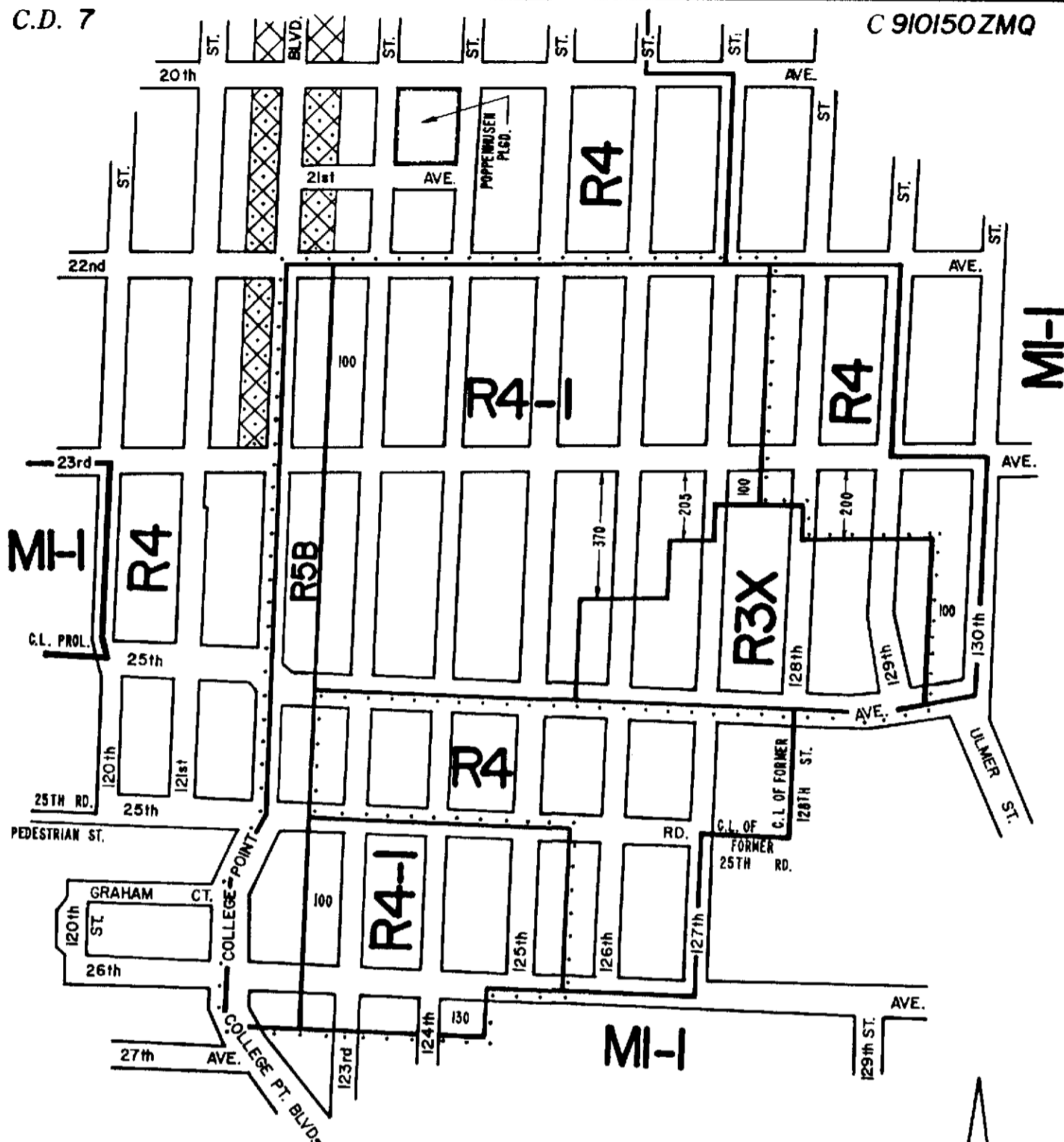

CITY PLANNING COMMISSION  
CITY OF NEW YORK

**DIAGRAM SHOWING PROPOSED  
ZONING CHANGE  
ON SECTIONAL MAP**

10a  
BOROUGH OF  
QUEENS

New York, Certification Date  
**April 15, 1991**

*Lawrence P. ...*  
 Director of Technical Review,  
 Land Use Review Division  
*Anthony J. Patrusini, P.E.*  
 Chief Engineer



**NOTE:**

- indicates Zoning District boundary.
- The area enclosed by the fine dotted line is proposed to be changed from R4 and MI-1 Districts to R4-1, R5B, and R3X Districts.
- indicates a C1-2 District
- indicates a C2-2 District.

**APPROVED BY CITY COUNCIL**

CALENDAR # 365

DATE 10-23-91

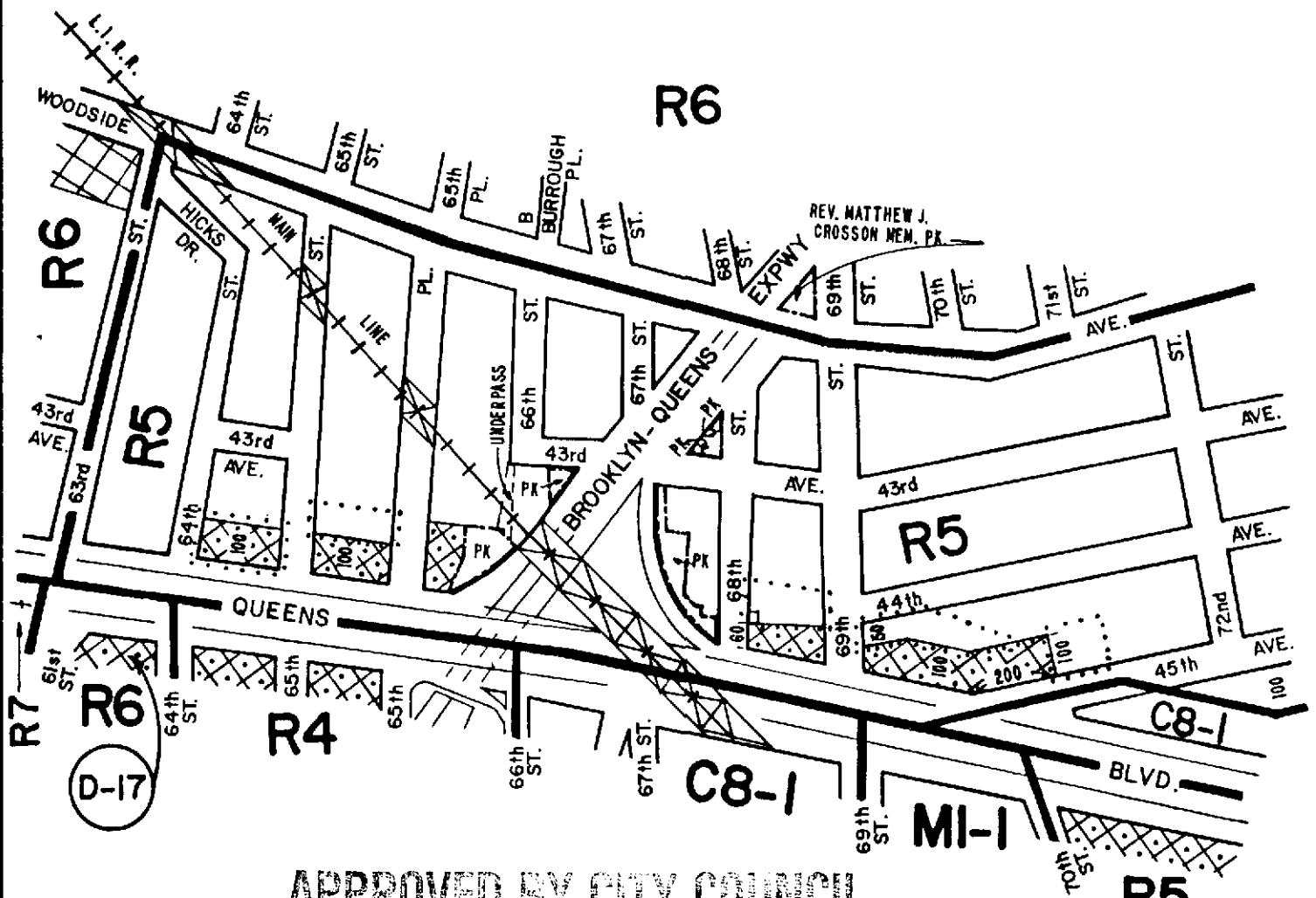

APPROVED BY CITY COUNCIL

CALENDAR # 523

DATE 12-5-91

Δ - 1626



CITY PLANNING COMMISSION  
CITY OF NEW YORK

DIAGRAM SHOWING PROPOSED  
ZONING CHANGE  
ON SECTIONAL MAP  
9d

BOROUGH OF  
QUEENS





New York, Certification Date  
September 16, 1991

*San Purvis*  
Director of Technical Review,  
Land Use Review Division

*Anthony J. Paterson, P.E.*  
Chief Engineer

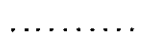

NOTE:

-  indicates Zoning District boundary.
-  The areas enclosed by the fine dotted lines are proposed to be changed by establishing and eliminating portions of C2-2 Districts within the existing R5 District.
-  indicates a C1-2 District.
-  indicates a C2-2 District.
-  indicates a Restrictive Declaration Area, refer to R.D. sheet.

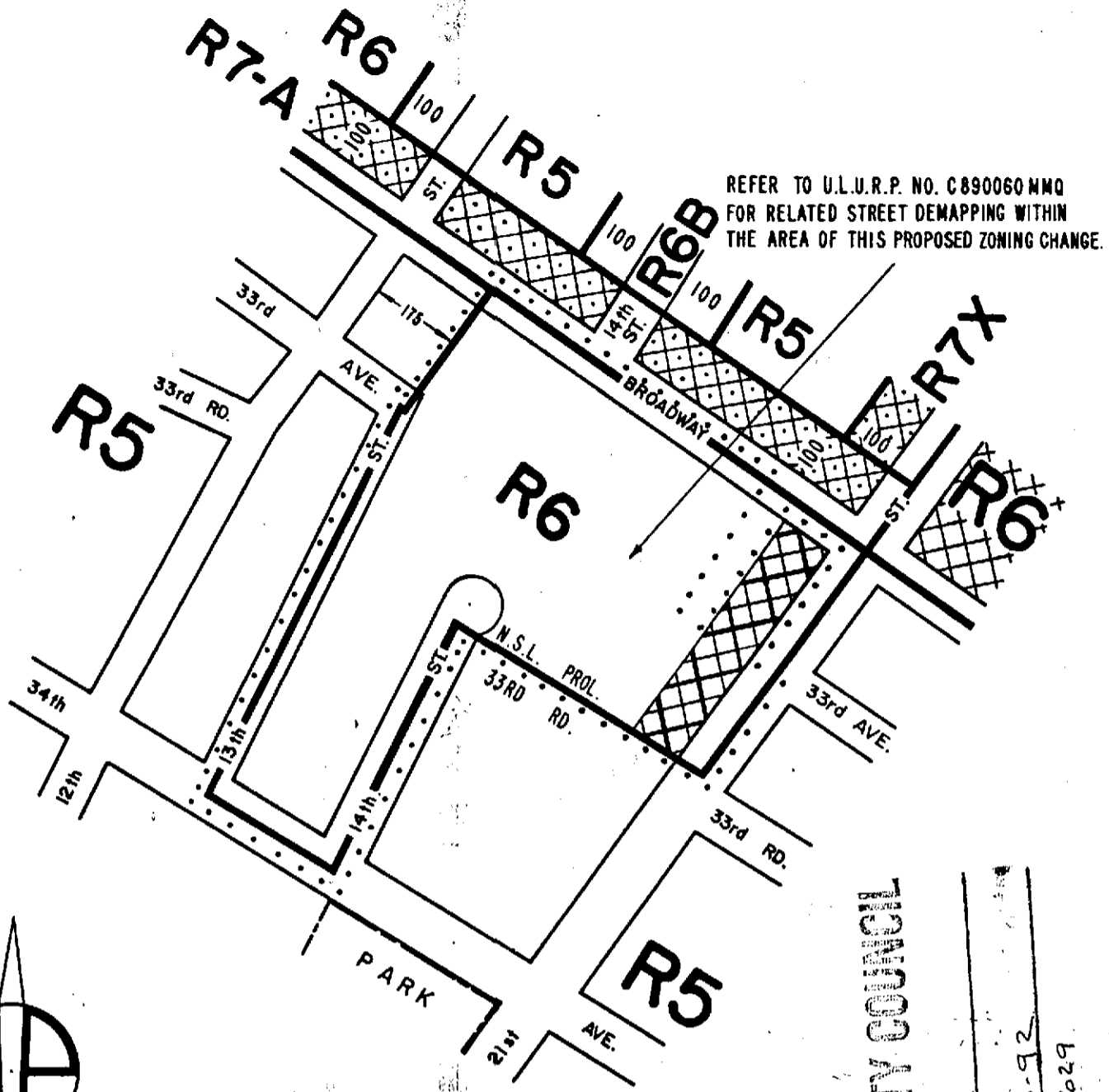

REFER TO U.L.U.R.P. NO. C890060MMQ FOR RELATED STREET DEMAPPING WITHIN THE AREA OF THIS PROPOSED ZONING CHANGE.

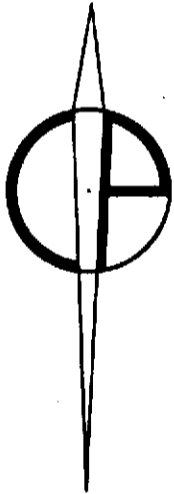

CITY PLANNING COMMISSION  
CITY OF NEW YORK

**DIAGRAM SHOWING PROPOSED ZONING CHANGE ON SECTIONAL MAP**

9a  
BOROUGH OF QUEENS

APPROVED BY CITY COUNCIL

CALENDAR # P.E.  
DATE 1-23-92  
4-1629

New York, Certification Date  
August 12, 1991

*[Signature]*  
Director of Technical Review,  
Land Use Review Division  
*[Signature]*  
Chief Engineer

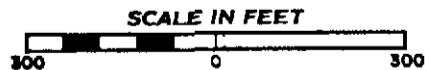

**NOTE:**

- indicates Zoning District boundary.
- .....** The area enclosed by the fine dotted line is proposed to be changed from an R5 District to an R6 District and by establishing a CI-4 District within the existing and proposed R6 Districts
- indicates a CI-2 District.
- indicates a CI-4 District.
- indicates a C2-2 District.

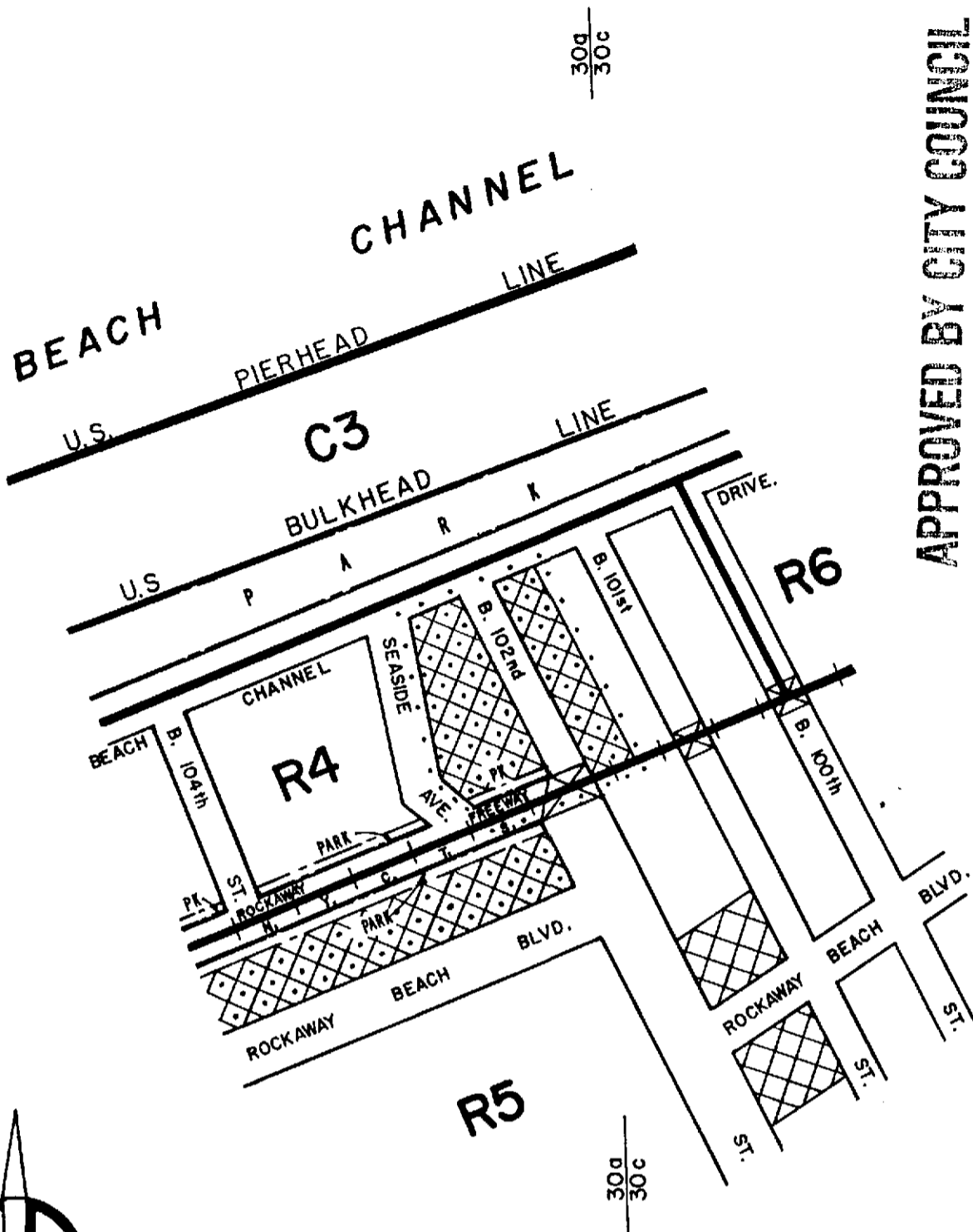

APPROVED BY CITY COUNCIL

CALENDAR # 857

DATE 8-26-92  
A-1641



CITY PLANNING COMMISSION  
CITY OF NEW YORK

DIAGRAM SHOWING PROPOSED  
ZONING CHANGE  
ON SECTIONAL MAPS



30a & 30c  
BOROUGH OF  
QUEENS

*Sam Puskas*  
 Director of Technical Review,  
 Land Use Review Division

New York, Certification Date  
February 10, 1992



NOTE:

- indicates Zoning District boundary.
- .....** The area enclosed by the fine dotted line is proposed to be changed by establishing a C2-2 District within an existing R4 District.
-  indicates a C2-2 District.
-  indicates a C1-2 District.

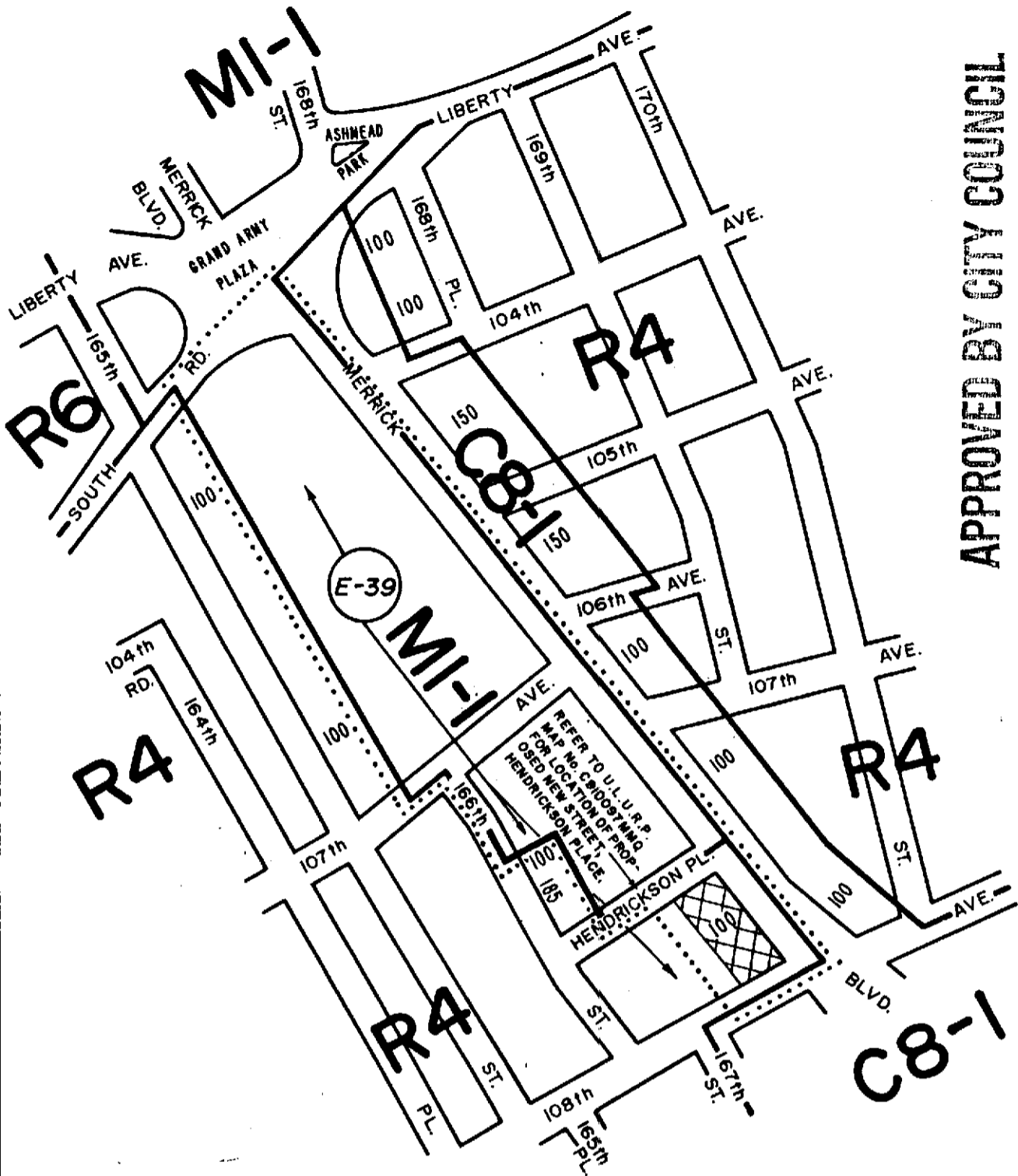

APPROVED BY CITY COUNCIL

CALENDAR # 918

DATE 10-8-92

4-1647

CITY PLANNING COMMISSION  
CITY OF NEW YORK

DIAGRAM SHOWING PROPOSED  
ZONING CHANGE  
ON SECTIONAL MAP  
14d  
BOROUGH OF  
QUEENS

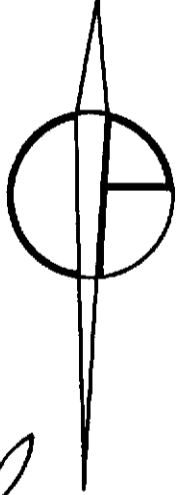

*Alvin K... ..*  
 Director of Technical Review  
 Land Use Review Division

New York, Certification Date  
 March 16, 1992  
 Revised June 29, 1992



- NOTE:**
- indicates Zoning District boundary.
  - The area enclosed by the fine dotted line is proposed to be changed from C8-1 and R4 Districts to MI-1 and R4 Districts and establishing a CI-2 District within the proposed R4 District.
  - indicates a CI-2 District.
  - indicates a City Environmental Quality Review Declaration, for detail refer to C.E.Q.R. sheet.

APPROVED BY CITY COUNCIL

CALENDAR # 922

M3-1

DATE 10-8-92

Δ - 16,45

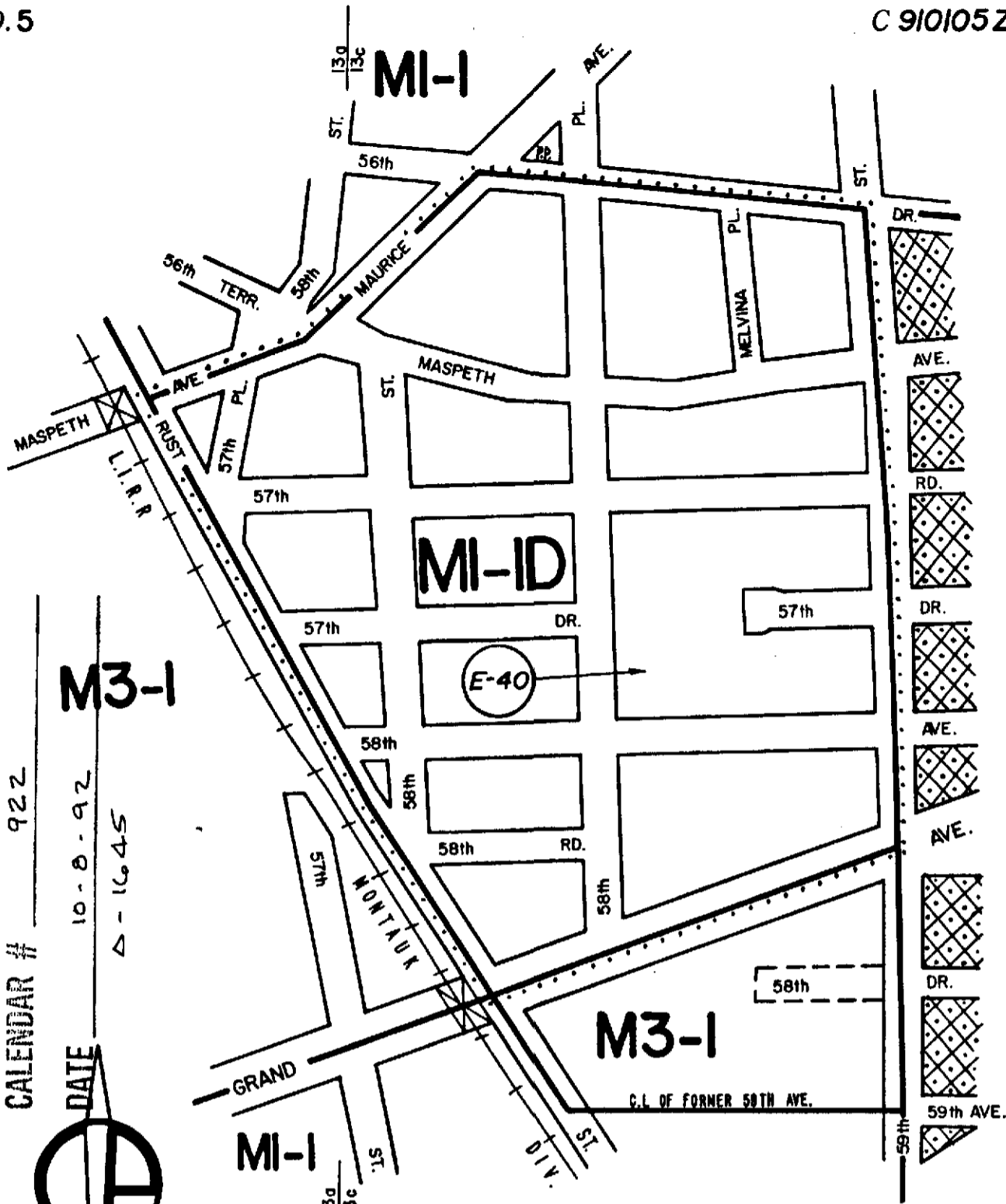

CITY PLANNING COMMISSION  
CITY OF NEW YORK

DIAGRAM SHOWING PROPOSED  
ZONING CHANGE  
ON SECTIONAL MAPS

13a & 13c  
BOROUGH OF  
QUEENS

*James P. ...*  
Director of Technical Review  
Land Use Review Division

New York, Certification Date  
April 20, 1992



NOTE:

- indicates Zoning District boundary.
- The area enclosed by the fine dotted line is proposed to be changed from MI-1 and M3-1 Districts to an MI-ID District.
- indicates a C2-2 District.
- indicates a City Environmental Quality Review Declaration, for detail refer to C.E.Q.R. sheet.



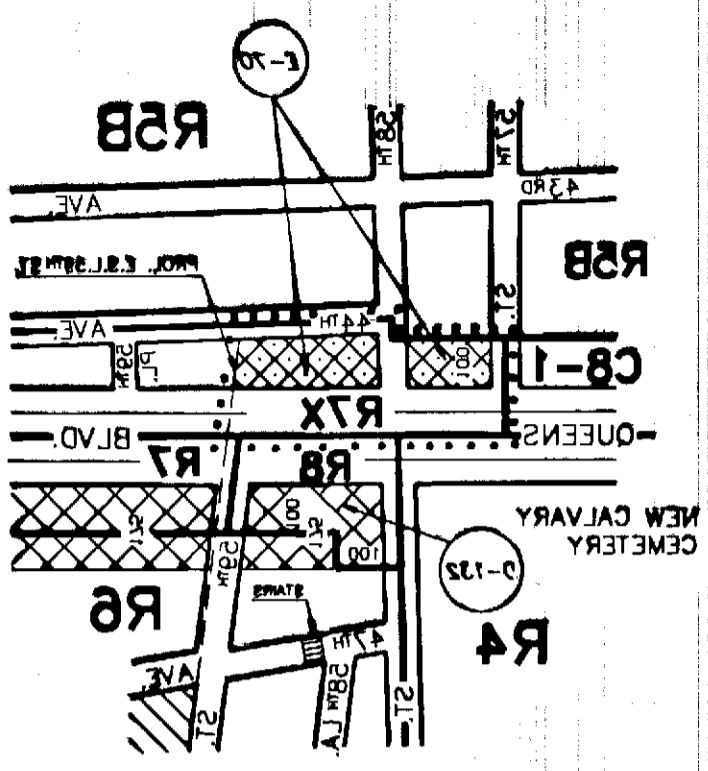

APPROVED BY CITY COUNCIL

CALENDAR # R. 1472

DATE 1-18-92

Mapping - 1-30-92  
A. 1704

CITY PLANNING COMMISSION  
CITY OF NEW YORK

DIAGRAM SHOWING PROPOSED  
ZONING CHANGE  
ON SECTIONAL MAP



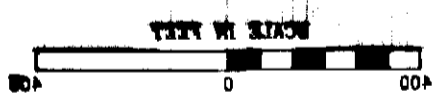

9b  
BOROUGH OF  
QUEENS

*[Signature]*  
Director of Technical Review

New York, Certification Date  
JULY 24, 1992

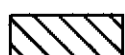

NOTE:

- ..... The area enclosed by the dotted line is proposed to be changed from a CB-1 District to an R7X District and establishing a CS-2 District within the proposed R7X District.
-  Indicates a C1-1 District.
-  Indicates a CS-2 District.
-  Indicates a C1-2 District.
-  Indicates a Restrictive Declaration Area, refer to R.D. sheet.
-  Indicates a City Environmental Quality Declaration, refer to C.E.Q.R. sheet.

THIS DIAGRAM IS FOR ILLUSTRATIVE PURPOSES ONLY.



MT. HEBRON CEMETERY (CEDAR GROVE)

CITY PLANNING COMMISSION  
CITY OF NEW YORK  
DIAGRAM SHOWING PROPOSED ZONING CHANGE ON SECTIONAL MAPS 14a & 14c  
BOROUGH OF QUEENS

New York, Certification Date  
October 7, 1991



*Alan Penn*  
Director of Technical Review,  
Land Use Review Division

- NOTE:**
-  indicates Zoning District boundary.
  -  the areas enclosed by the fine dotted lines are proposed to be changed from R2, R3-2 & R4 Districts to R2, R4, R4-1 & R4B Districts, by eliminating CI-2 Districts from the existing R4 District and by establishing CI-2 Districts within the existing R4 District.
  -  indicates a CI-2 District.

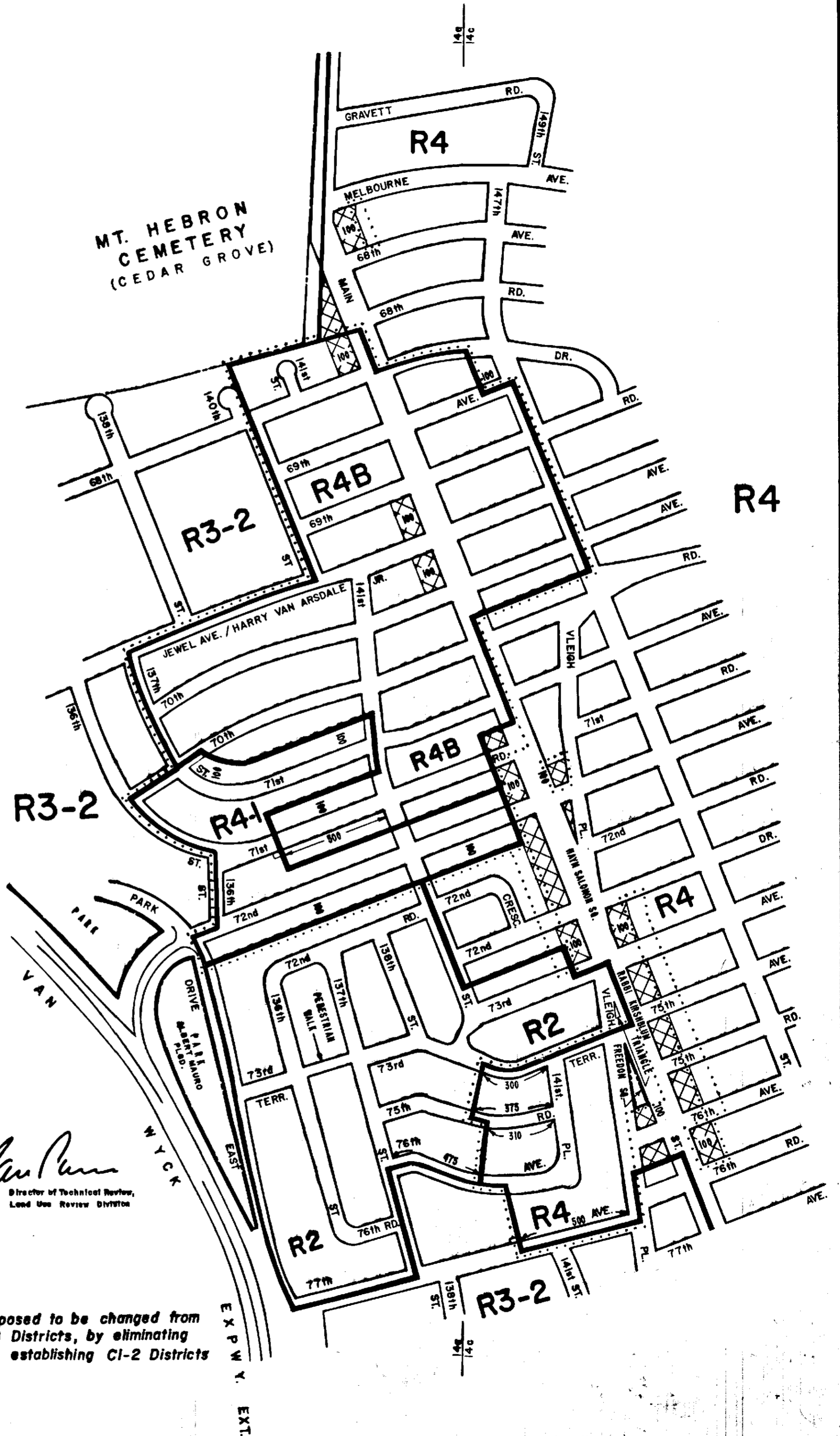

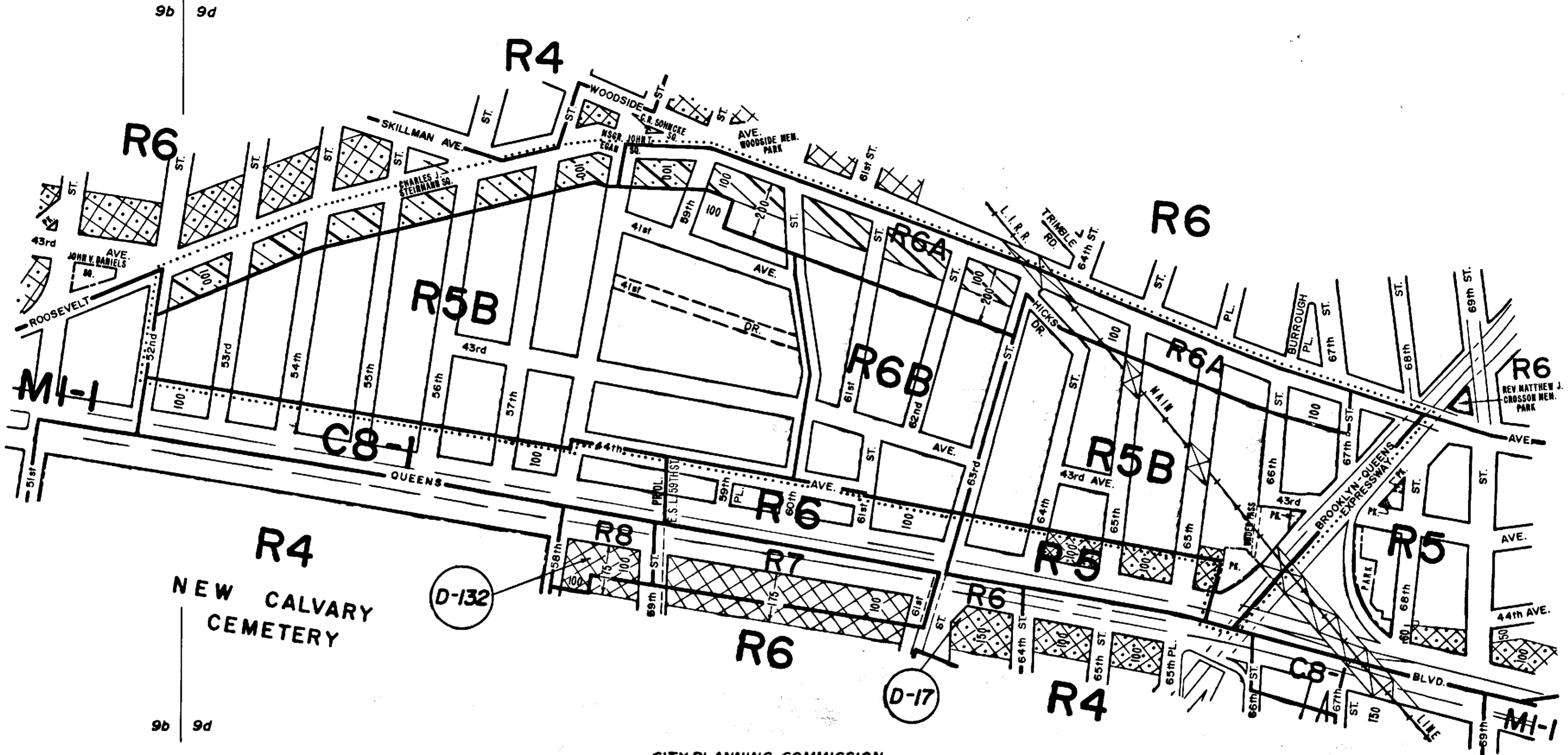

9b 9d

9b 9d

CITY PLANNING COMMISSION  
CITY OF NEW YORK

DIAGRAM SHOWING PROPOSED  
ZONING CHANGE  
ON SECTIONAL MAPS  
9b & 9d  
BOROUGH OF  
QUEENS

New York, Certification Date  
February 24, 1992



**NOTE:**

- Indicates Zoning District boundary.
- ..... The area enclosed by the fine dotted line is proposed to be changed from R5 and R6 Districts to R5B, R6A and R6B Districts, eliminating C1-2 and C2-2 Districts from within an existing R6 District, establishing a C2-3 District within an existing R6 District and establishing C1-3 and C2-3 Districts within the proposed R6A District.

- indicates a C1-2 District.
- indicates a C2-2 District.
- indicates a C1-3 District.
- indicates a C2-3 District.
- indicates a Restrictive Declaration Area, refer to R.D. sheet.

*Samuel Parnes*  
Director of Technical Review,  
Land Use Review Division

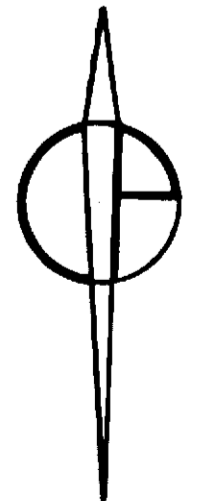

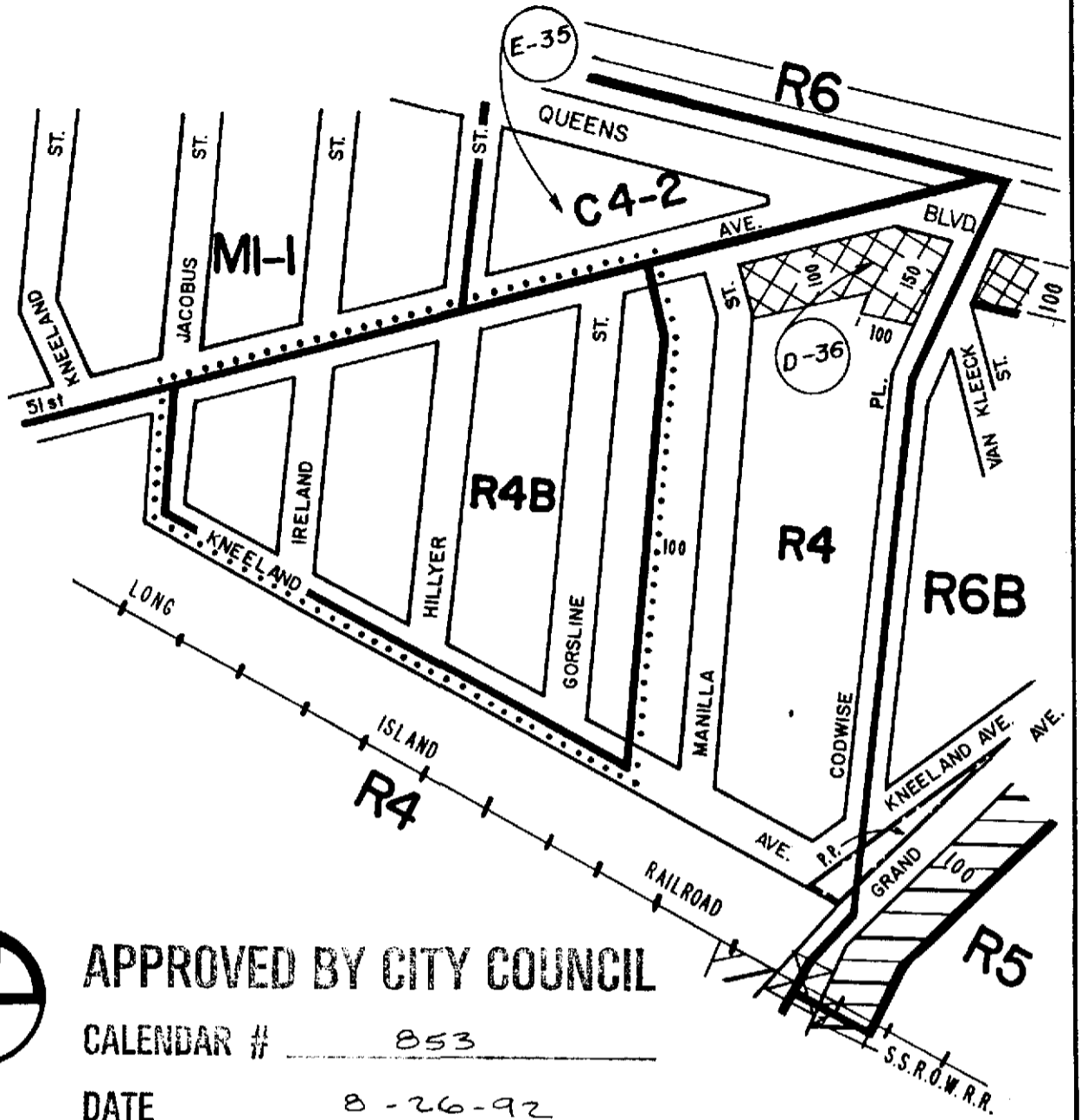

APPROVED BY CITY COUNCIL

CALENDAR # 853

DATE 8-26-92

Δ-1643

CITY PLANNING COMMISSION  
CITY OF NEW YORK

DIAGRAM SHOWING PROPOSED  
ZONING CHANGE  
ON SECTIONAL MAP

13c

BOROUGH OF  
QUEENS

*Samuel Peres*  
 Director of Technical Review,  
 Land Use Review Division

New York, Certification Date  
February 24, 1992



NOTE:

- indicates Zoning District boundary.
- .....** The area enclosed by the fine dotted line is proposed to be changed from an R4 District to an R4B District.
- (D)** indicates a Restrictive Declaration Area, refer to R.D. sheet.
- (E)** indicates a City Environmental Quality Review Declaration, refer to C.E.Q.R sheet.

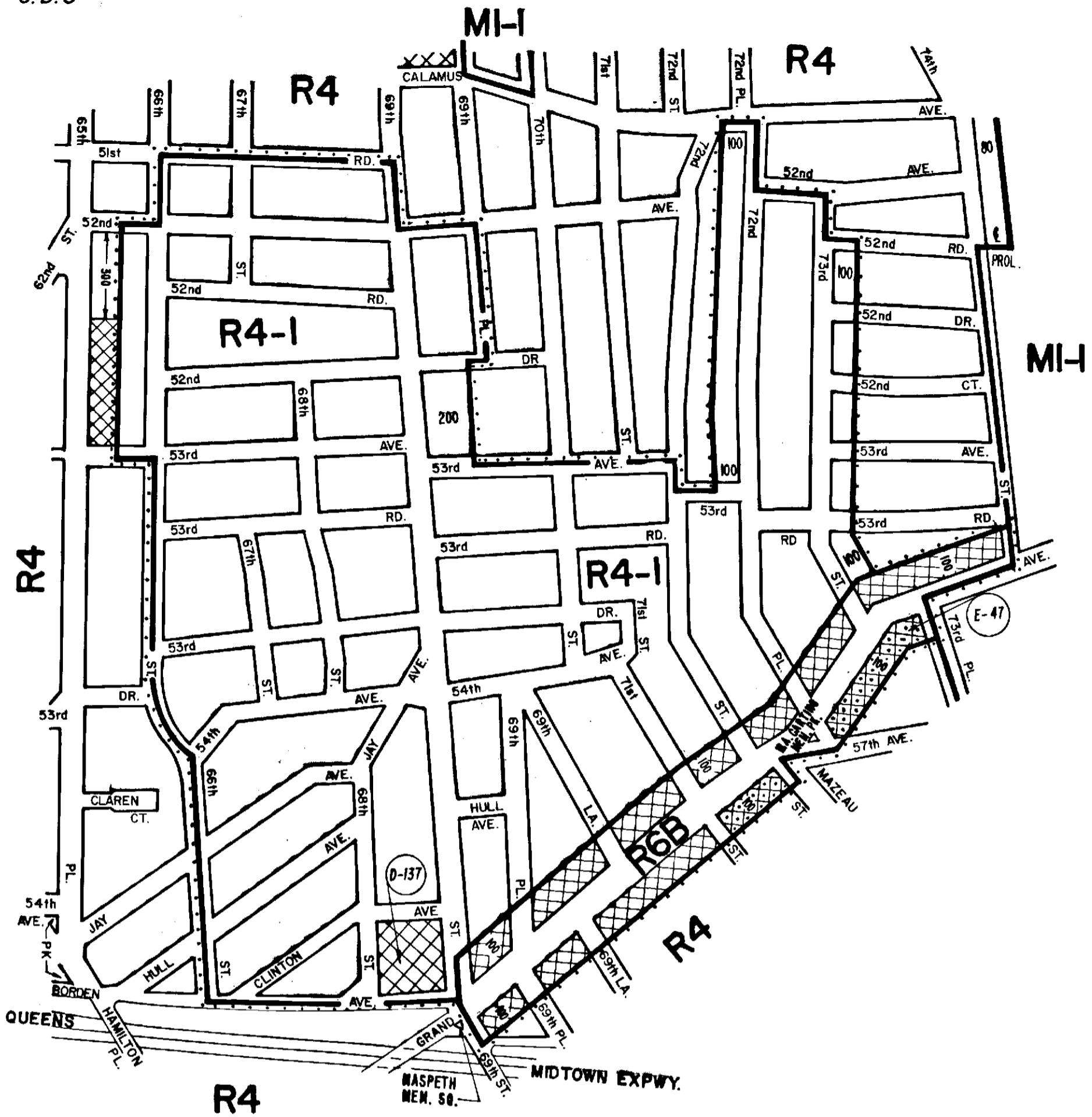

CITY PLANNING COMMISSION  
 CITY OF NEW YORK  
 DIAGRAM SHOWING PROPOSED  
 ZONING CHANGE  
 ON SECTIONAL MAP  
 13c  
 BOROUGH OF  
 QUEENS

New York, Certification Date  
 July 19, 1993

*Anna Peres*  
 Director of Technical Review,  
 Land Use Review Division



**NOTE:**

- Indicates Zoning District boundary.
- ..... The area enclosed by the fine dotted line is proposed to be changed from an R4 District to R4-1 and R6B Districts and eliminate portions of C1-2 District within the existing R4 and the proposed R4-1 Districts.
- ▨ Indicates a C1-2 District.
- ▧ Indicates a C2-2 District.
- (E) Indicates a City Environmental Quality Review Declaration, refer to C.E.Q.R. sheet.
- (D) Indicates a Restrictive Declaration Area, refer to R.D. sheet.

THIS DIAGRAM IS FOR ILLUSTRATIVE PURPOSES ONLY.

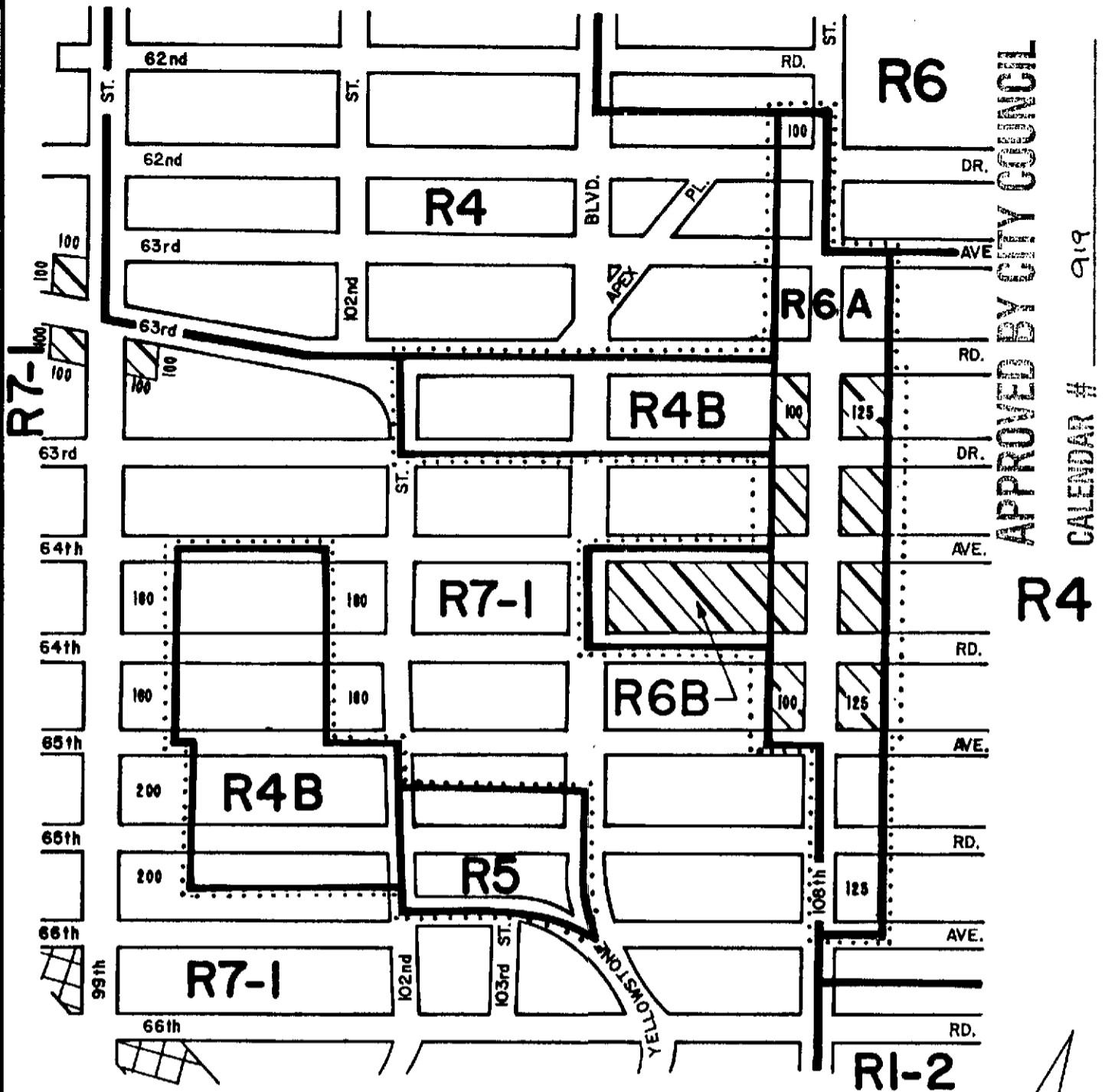

APPROVED BY CITY COUNCIL

CALENDAR # 919

DATE 10-8-92

A-1646

CITY PLANNING COMMISSION  
CITY OF NEW YORK

DIAGRAM SHOWING PROPOSED  
ZONING CHANGE  
ON SECTIONAL MAP

14a  
BOROUGH OF  
QUEENS

New York, Certification Date  
April 6, 1992  
Revised August 7, 1992

*Shirley L. ...*  
Director of Technical Review,  
Land Use Review Division



NOTE:

- indicates Zoning District boundary.
- The areas enclosed by the fine dotted lines are proposed to be changed from R4 and R7-1 Districts to R6A, R6B, R4B, R7-1 and R5 Districts and by eliminating CI-2 Districts within an existing R4 District and establishing CI-3 Districts within the proposed R6A and R6B Districts.
- indicates a CI-3 District.
- indicates a CI-2 District.

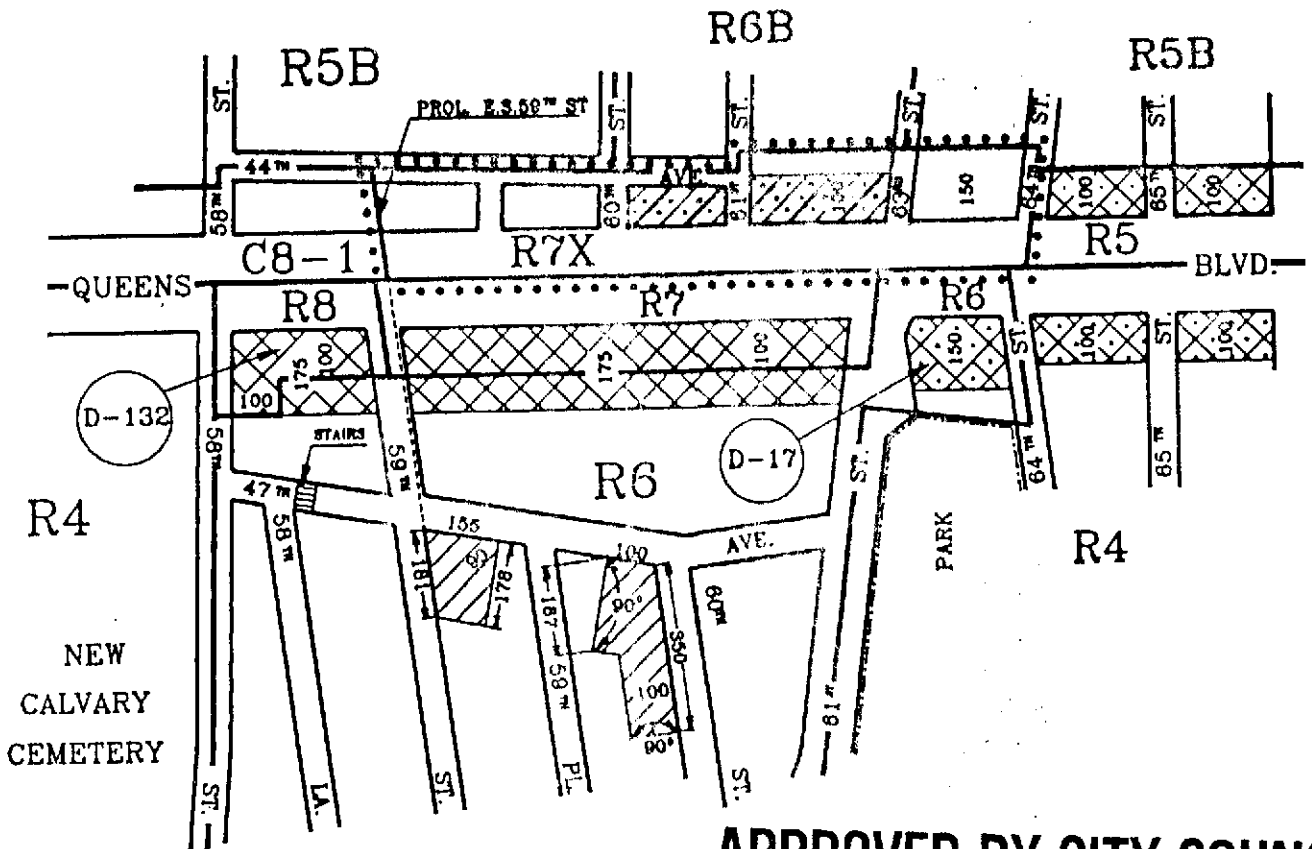

**APPROVED BY CITY COUNCIL**

*RES*  
**CALENDAR # 1761**

**DATE 12-21-93**

*Date Mapped 3-16-94*

**CITY PLANNING COMMISSION  
CITY OF NEW YORK**

*A-1665*



**DIAGRAM SHOWING PROPOSED  
ZONING CHANGE  
ON SECTIONAL MAP  
9d  
BOROUGH OF  
QUEENS**

*Laura Paris*  
Director of Technical Review,  
Land Use Review Division

New York, Certification Date  
**July 12, 1993**



**NOTE:**

- Indicates Zoning District boundary.
- The area enclosed by the fine dotted line is proposed to be changed from R5, R5B, R6 and R6B Districts to an R7X District, and by establishing a C2-3 District within the proposed R7X District.
- Indicates a C1-2 District.
- Indicates a C2-2 District.
- Indicates a C2-3 District.
- Indicates a Restrictive Declaration Area, refer to R.D. sheet.

**THIS DIAGRAM IS FOR ILLUSTRATIVE PURPOSES ONLY.**

APPROVED BY CITY COUNCIL

RES. CALENDAR # 209

DATE 03-16-94

DATE MAPLED: 4-11-94

A.1671

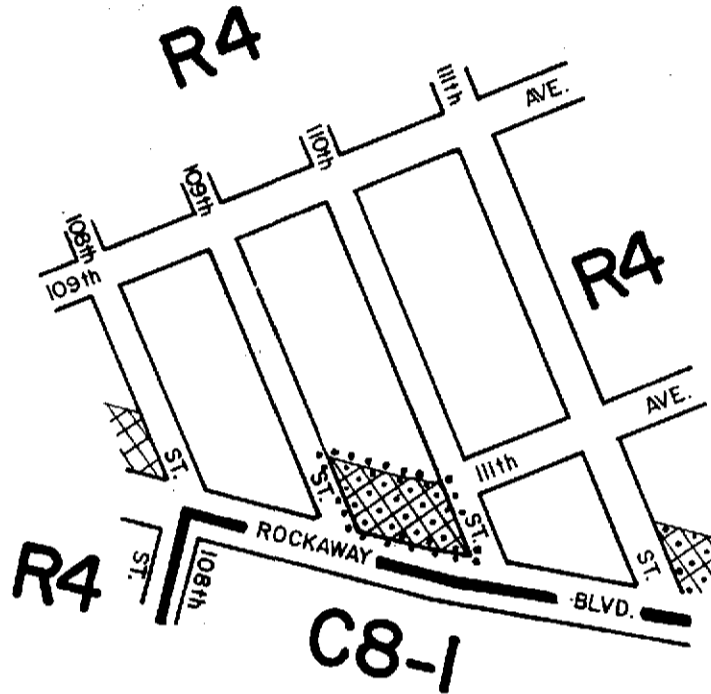

CITY PLANNING COMMISSION  
CITY OF NEW YORK

DIAGRAM SHOWING PROPOSED  
ZONING CHANGE  
ON SECTIONAL MAP

18a  
BOROUGH OF  
QUEENS

New York, Certification Date  
October 4, 1993

*Sam Pines*  
Director of Technical Review,  
Land Use Review Division



NOTE:

- indicates Zoning District boundary.
- The area enclosed by the fine dotted line is proposed to be changed by establishing a C2-2 District within an existing R4 District.
- indicates a C2-2 District.
- indicates a C1-2 District.

THIS DIAGRAM IS FOR ILLUSTRATIVE PURPOSES ONLY.



# APPROVED BY CITY COUNCIL

RES. CALENDAR # 210

DATE 03-16-94

DATE MAPPED 4-13-94

R4

A 1672

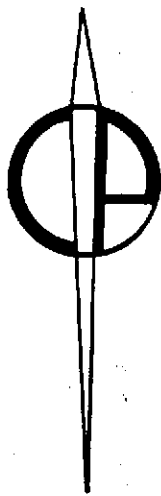
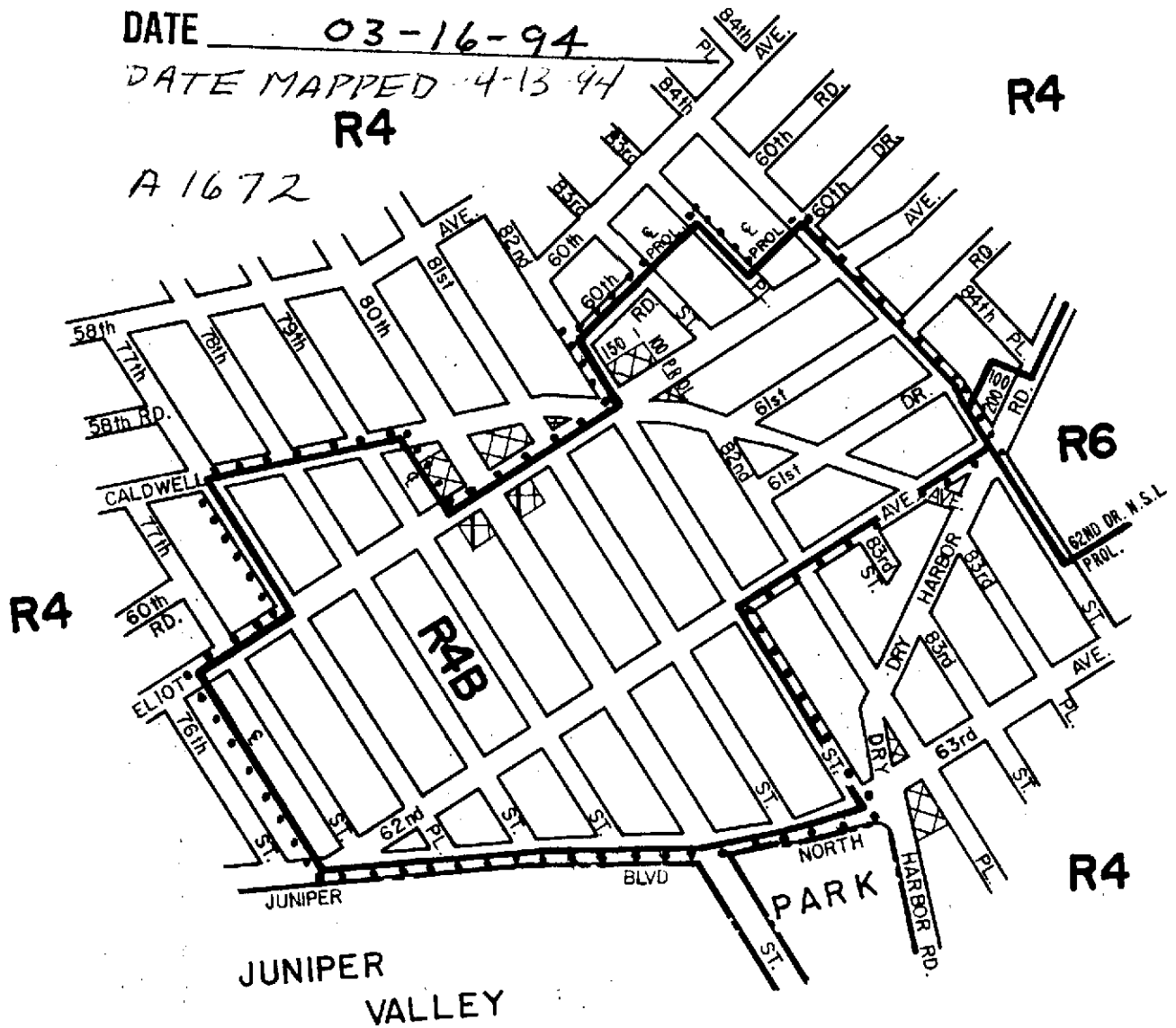

CITY PLANNING COMMISSION  
CITY OF NEW YORK

## DIAGRAM SHOWING PROPOSED ZONING CHANGE ON SECTIONAL MAP

13c

BOROUGH OF  
QUEENS

New York, Certification Date  
October 4, 1993

*[Signature]*  
 Director of Technical Review  
 Land Use Review Division



**NOTE:**

- indicates Zoning District boundary.
  - The area enclosed by the fine dotted line is proposed to be changed from an R4 District to an R4B District, and by eliminating a CI-2 District and establishing a CI-4 District.
  - indicates a CI-2 District.
  - indicates a CI-4 District.
- THIS DIAGRAM IS FOR ILLUSTRATIVE PURPOSES ONLY.

# APPROVED BY CITY COUNCIL

CALENDAR # 357

*ZONING MAP SHOWS*

DATE 5-24-94

*R3-2 date mapped 9-14-94*

*A-1676*

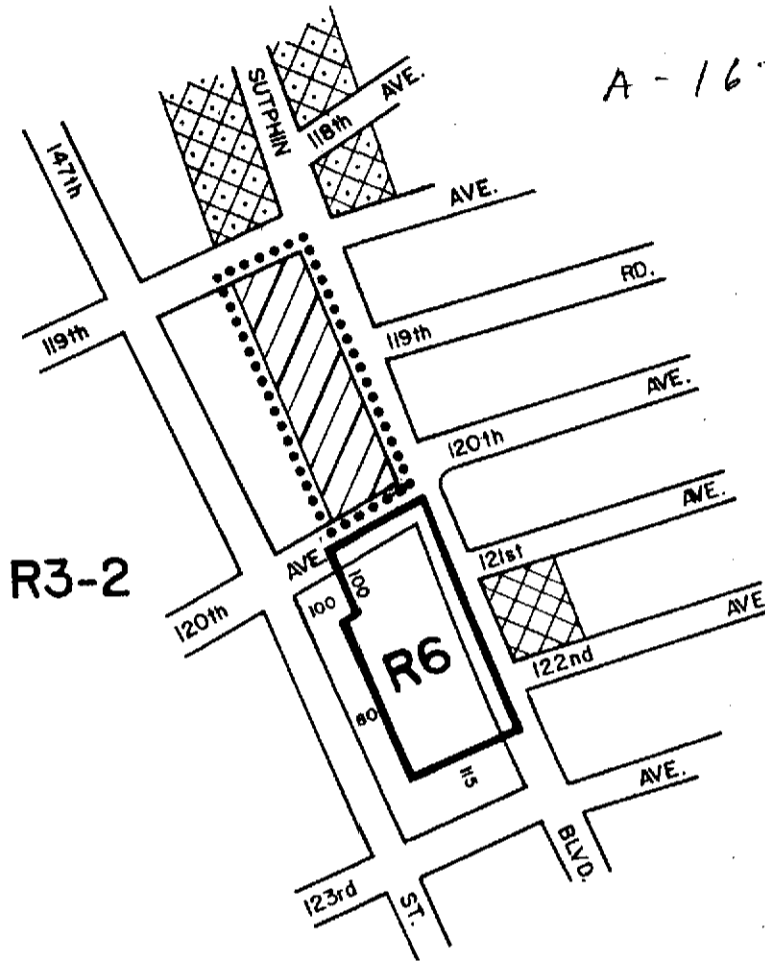

R3-2



CITY PLANNING COMMISSION  
CITY OF NEW YORK

## DIAGRAM SHOWING PROPOSED ZONING CHANGE ON SECTIONAL MAP



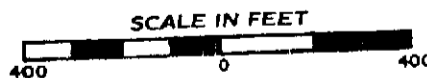

18c  
BOROUGH OF QUEENS

*James Purves*  
 Director of Technical Review,  
 Land Use Review Division

New York, Certification Date  
November 29, 1993



**NOTE:**

-  indicates Zoning District boundary.
-  The area enclosed by the fine dotted line is proposed to be changed by eliminating a C1-2 District and establishing a C1-3 District.
-  Indicates a C1-2 District.
-  Indicates a C2-2 District.
-  Indicates a C1-3 District.

THIS DIAGRAM IS FOR ILLUSTRATIVE PURPOSES ONLY.



APPROVED BY CITY COUNCIL

CALENDAR # 409

DATE 6-9-94

*date mapped 7-19-94*

A-1677

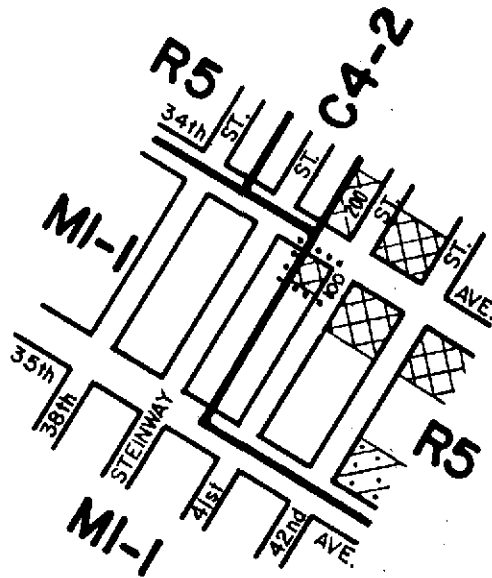

CITY PLANNING COMMISSION  
CITY OF NEW YORK

**DIAGRAM SHOWING PROPOSED  
ZONING CHANGE  
ON SECTIONAL MAP**

9b

BOROUGH OF  
QUEENS

New York, Certification Date  
December 20, 1993

*San Pare*  
Director of Technical Review  
Land Use Review Division



**NOTE:**

- indicates Zoning District boundary.
- The area enclosed by the fine dotted line is proposed to be changed by establishing a C1-2 District within an existing R5 District.
- indicates a C1-2 District.
- indicates a C2-3 District.

**THIS DIAGRAM IS FOR ILLUSTRATIVE PURPOSES ONLY.**

APPROVED BY CITY COUNCIL

CALENDAR # 410

DATE 6-9-94

Date mapped 7-19-94

A 1678

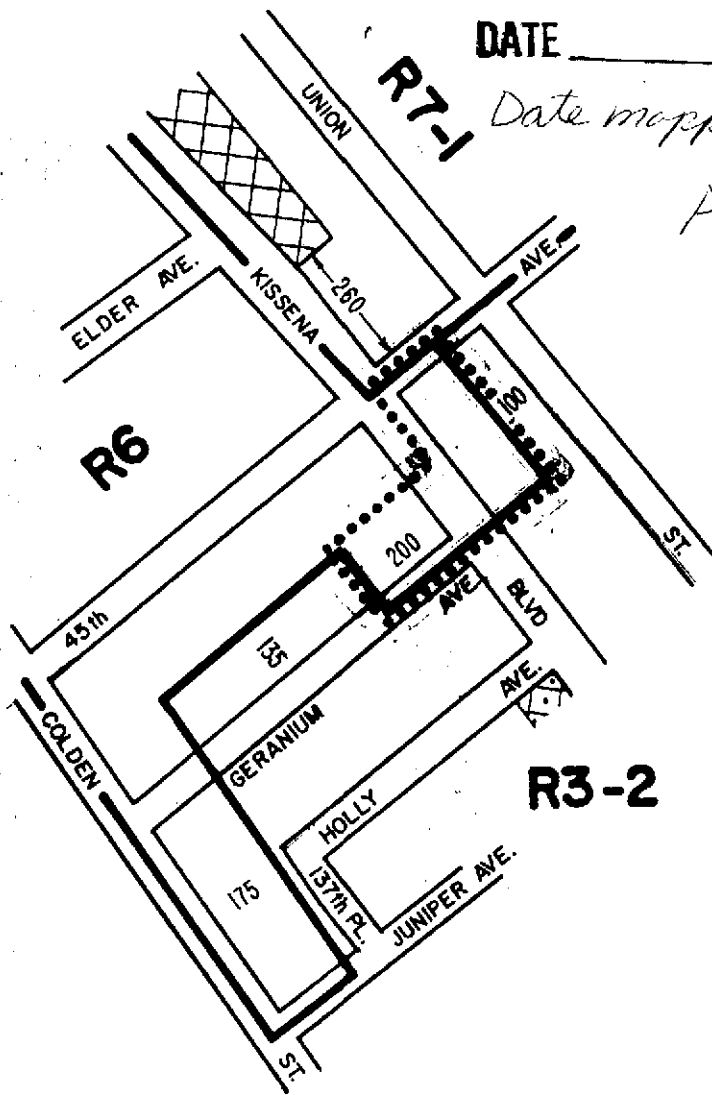
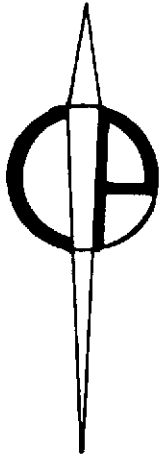

CITY PLANNING COMMISSION  
CITY OF NEW YORK

DIAGRAM SHOWING PROPOSED  
ZONING CHANGE  
ON SECTIONAL MAP

10d  
BOROUGH OF  
QUEENS

New York, Certification Date  
January 3, 1994

*[Signature]*  
Director of Technical Review,  
Land Use Review Division



NOTE:

- Indicates Zoning District boundary.
- The area enclosed by the fine dotted line is proposed to be changed from R3-2 District to R6 District.
- Indicates a C1-2 District.
- Indicates a C2-2 District.

THIS DIAGRAM IS FOR ILLUSTRATIVE PURPOSES ONLY.

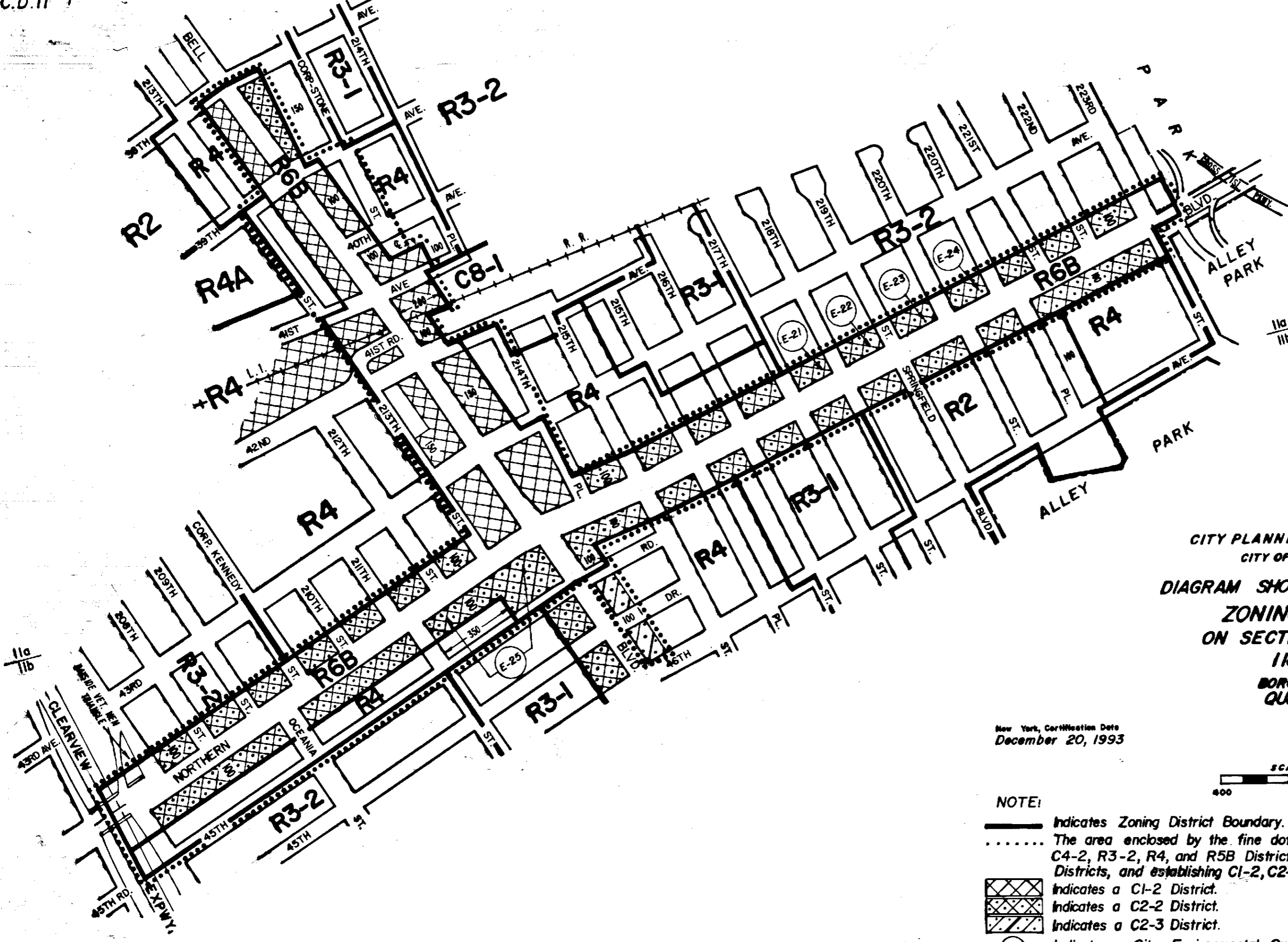



CITY PLANNING COMMISSION  
 CITY OF NEW YORK  
 DIAGRAM SHOWING PROPOSED  
 ZONING CHANGE  
 ON SECTIONAL MAP  
 11a & 11b  
 BOROUGH OF  
 QUEENS

New York, Certification Date  
 December 20, 1993

*[Signature]*  
 DIRECTOR OF TECHNICAL REVIEW,  
 Land Use Review Division



NOTE:

- Indicates Zoning District Boundary.
  - ..... The area enclosed by the fine dotted line is proposed to be changed by changing C4-2, R3-2, R4, and R5B Districts to R4 and R6B Districts, eliminating C1-1, C2-1, and C2-2 Districts, and establishing C1-2, C2-2 and C2-3 Districts.
  -  Indicates a C1-2 District.
  -  Indicates a C2-2 District.
  -  Indicates a C2-3 District.
  - (E) Indicates a City Environmental Quality Review Declaration, refer to C. E. Q. R. sheet.
- THIS DIAGRAM IS FOR ILLUSTRATIVE PURPOSES ONLY.

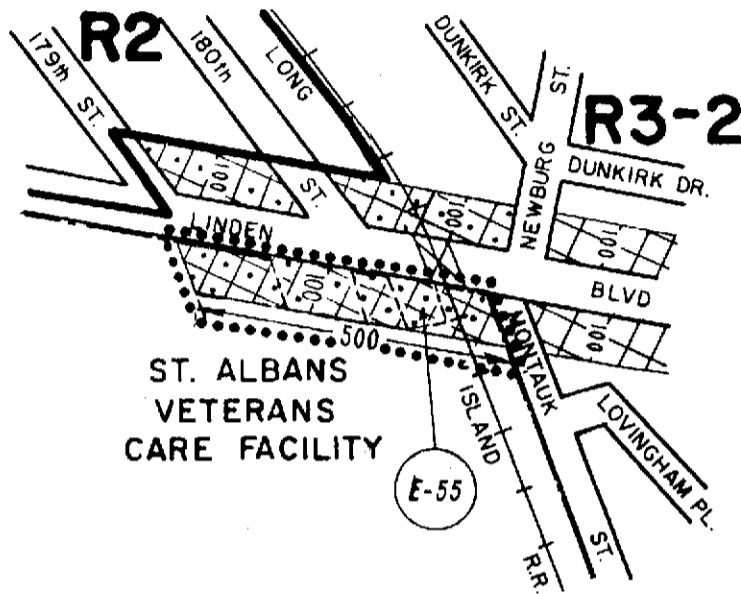

### APPROVED BY CITY COUNCIL

CALENDAR # 619

DATE 9/22/94

*date mapped* 10/28/92

*A-1686*

CITY PLANNING COMMISSION  
CITY OF NEW YORK

### DIAGRAM SHOWING PROPOSED ZONING CHANGE ON SECTIONAL MAP 19a



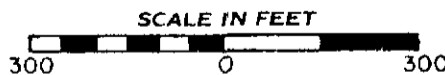

BOROUGH OF  
QUEENS

*Sam Parson*  
 Director of Technical Review  
 Land Use Review Division

New York, Certification Date  
**March 28, 1994**

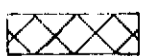

**NOTE:**

-  indicates Zoning District boundary.
  -  The area enclosed by the fine dotted line is proposed to be changed by establishing a C2-2 District within an existing R3-2 District.
  -  indicates a C1-2 District.
  -  indicates a C2-2 District.
  -  indicates a City Environmental Quality Review Declaration, refer to C.E.Q.R sheet.
- THIS DIAGRAM IS FOR ILLUSTRATIVE PURPOSES ONLY.**

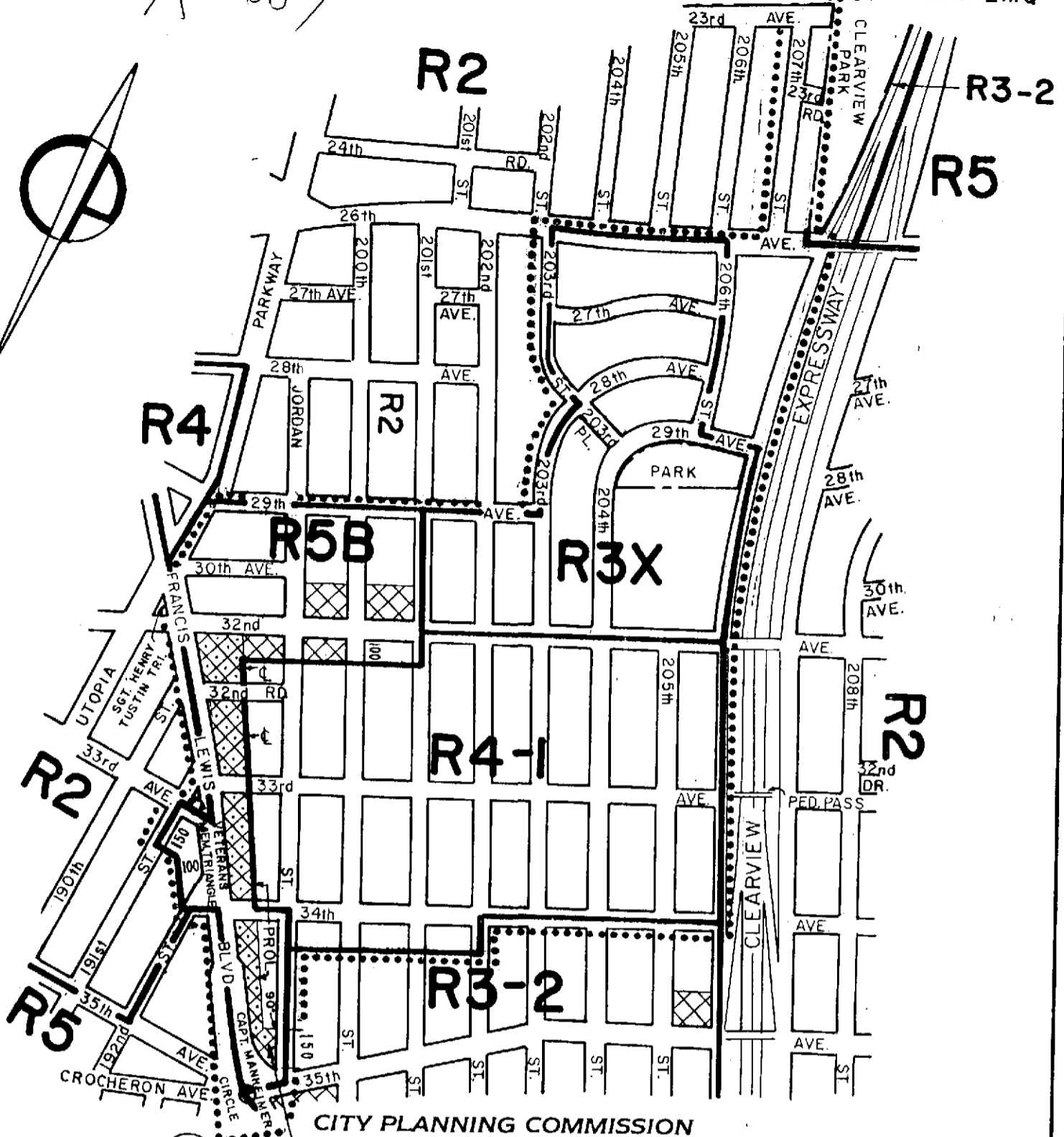
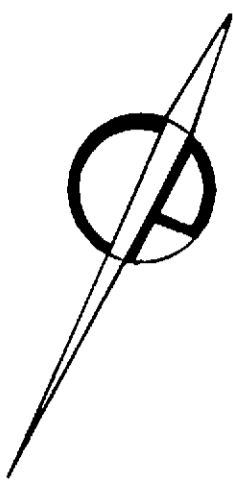

CITY PLANNING COMMISSION  
CITY OF NEW YORK

APPROVED BY CITY COUNCIL

CALENDAR # 854

DATE 2-15-95

DATE MAPPED 3-7-95

DIAGRAM SHOWING PROPOSED  
ZONING CHANGE  
ON SECTIONAL MAP

10c  
BOROUGH OF  
QUEENS

Director of Technical Review  
Land Use Review Division

New York, Certification Date  
August 22, 1994



NOTE:

- indicates Zoning District boundary.
- The area enclosed by the fine dotted line is proposed to be changed from R3-2 and R4 Districts to R2, R3X, R4-1 and R5B Districts.
- indicates a C1-2 District.
- indicates a C2-2 District.
- indicates a City Environmental Quality Review Declaration, Refer to C.E.Q.R. sheet.

THIS DIAGRAM IS FOR ILLUSTRATIVE PURPOSES ONLY.

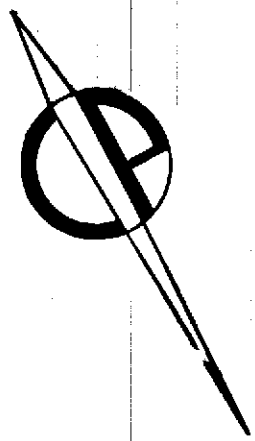
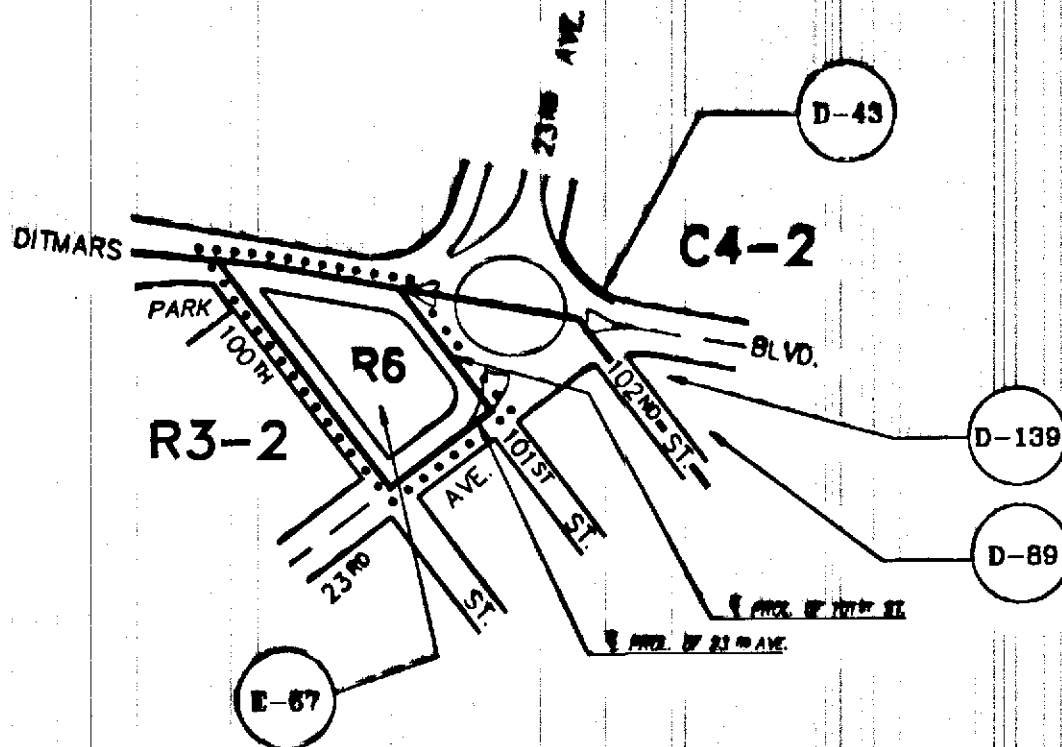

APPROVED BY CITY COUNCIL

CALENDAR # R 1406

DATE 12-7-1995  
A-1701

CITY PLANNING COMMISSION  
CITY OF NEW YORK

DIAGRAM SHOWING PROPOSED  
ZONING CHANGE  
ON SECTIONAL MAP

**9c**  
BOROUGH OF  
QUEENS

Director of Technical Review

New York, Certification Date  
JULY 10, 1995

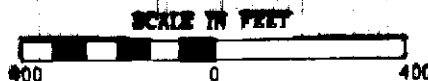

**NOTE:**

- Indicates Zoning District boundary.
- The area enclosed by the dotted line is proposed to be changed from an R3-2 District to an R6 District.
- Indicates a Restrictive Declaration Area, refer to R.D. sheet.
- Indicates a City Environmental Quality Declaration, refer to C.E.Q.R. sheet.

THIS DIAGRAM IS FOR ILLUSTRATIVE PURPOSES ONLY.



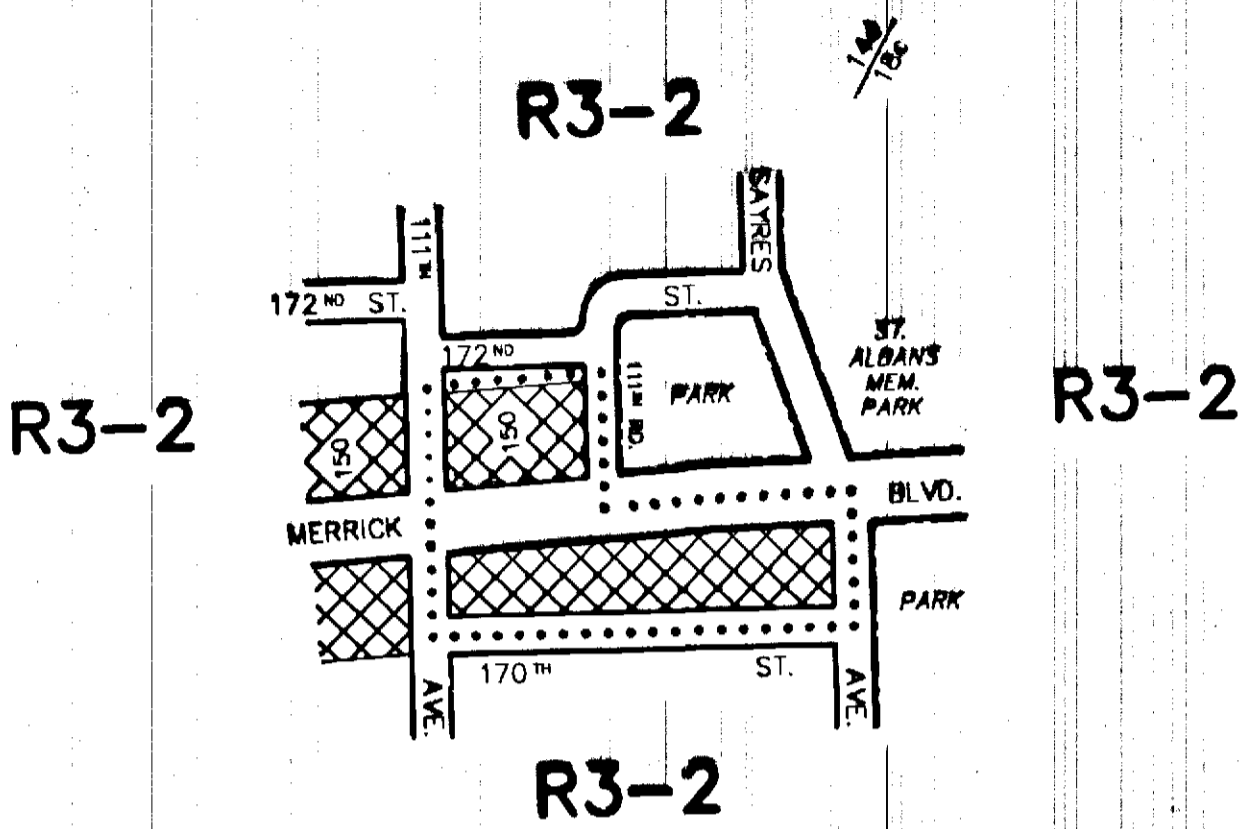

**APPROVED BY CITY COUNCIL**

**CALENDAR #** R. 1549

**DATE** 3/6/96

A 1707

**CITY PLANNING COMMISSION  
CITY OF NEW YORK**

**DIAGRAM SHOWING PROPOSED  
ZONING CHANGE  
ON SECTIONAL MAP  
14d & 18c  
BOROUGH OF  
QUEENS**

*Director of Technical Review*

New York, Certification Date  
SEPTEMBER 12, 1995

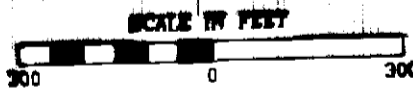

**NOTE:**

..... The area enclosed by the dotted line is proposed to be changed by establishing a CI-2 District in an existing R3-2 District.



Indicates a CI-2 District.

**THIS DIAGRAM IS FOR ILLUSTRATIVE PURPOSES ONLY.**

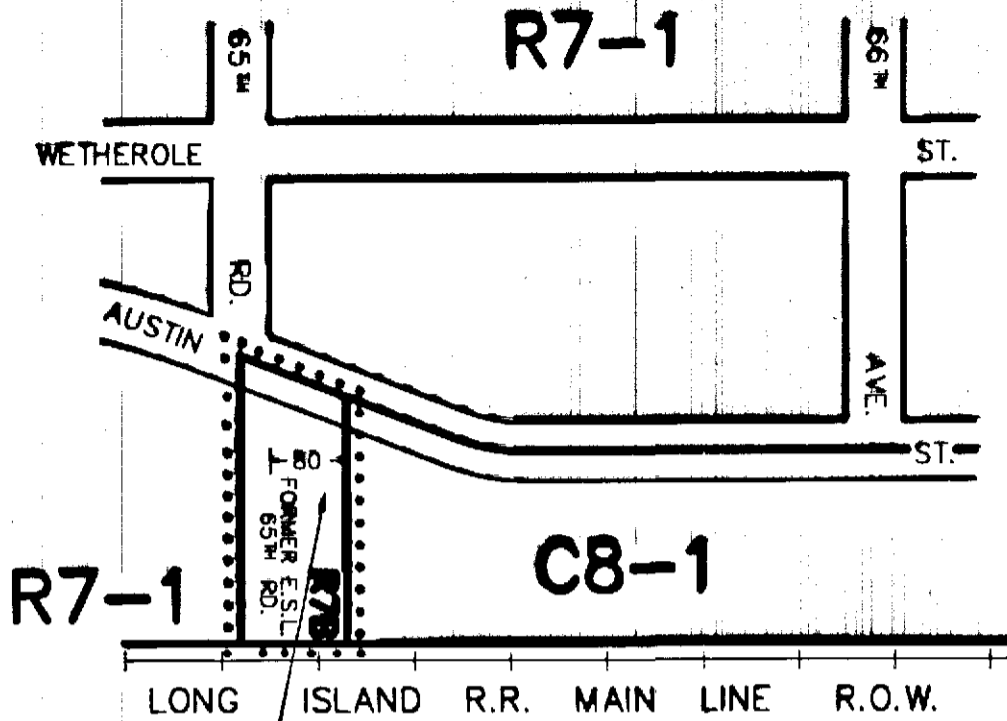

NOTE: REFER TO APPLICATION C 950096 MMQ FOR THE ELIMINATION OF 65TH ROAD.

APPROVED BY CITY COUNCIL

CALENDAR # 1763

DATE 6-5-96  
A 1713



CITY PLANNING COMMISSION  
CITY OF NEW YORK

DIAGRAM SHOWING PROPOSED  
ZONING CHANGE  
ON SECTIONAL MAP



**14a**  
BOROUGH OF  
QUEENS

*Laura Purns*  
Director of Technical Review

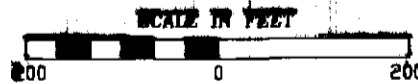
New York, Certification Date  
NOVEMBER 27, 1995  
As modified  
APRIL 24, 1996



NOTE:

-  Indicates Zoning District boundary.
-  The area enclosed by the dotted line is proposed to be changed from a C8-1 District to an R7B District.
-  Indicates a City Environmental Quality Declaration, refer to C.E.Q.R. sheet.

THIS DIAGRAM IS FOR ILLUSTRATIVE PURPOSES ONLY.

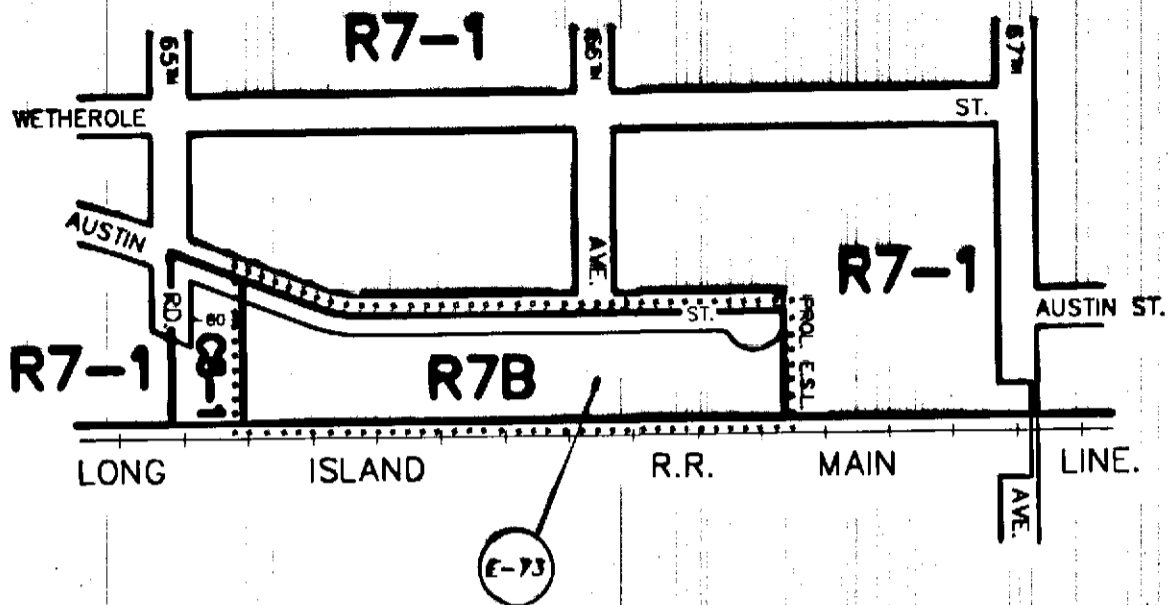

**APPROVED BY CITY COUNCIL**  
 CALENDAR # R. 1763  
 DATE 6-5-96  
 A. 1712



CITY PLANNING COMMISSION  
 CITY OF NEW YORK

DIAGRAM SHOWING PROPOSED  
**ZONING CHANGE**  
 ON SECTIONAL MAP  
**14a**  
 BOROUGH OF  
**QUEENS**

*[Signature]*  
 Director of Technical Review

New York, Certification Date  
 NOVEMBER 27, 1995  
 Modified  
 APRIL 24, 1996

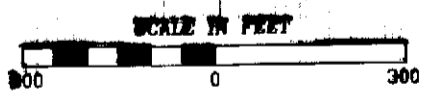

- NOTE:**
- Indicates Zoning District boundary.
  - The area enclosed by the dotted line is proposed to be changed from a C8-1 District to an R7B District.
  - Indicates a City Environmental Quality Declaration, refer to C.E.Q.R. sheet.

THIS DIAGRAM IS FOR ILLUSTRATIVE PURPOSES ONLY.

A-1693

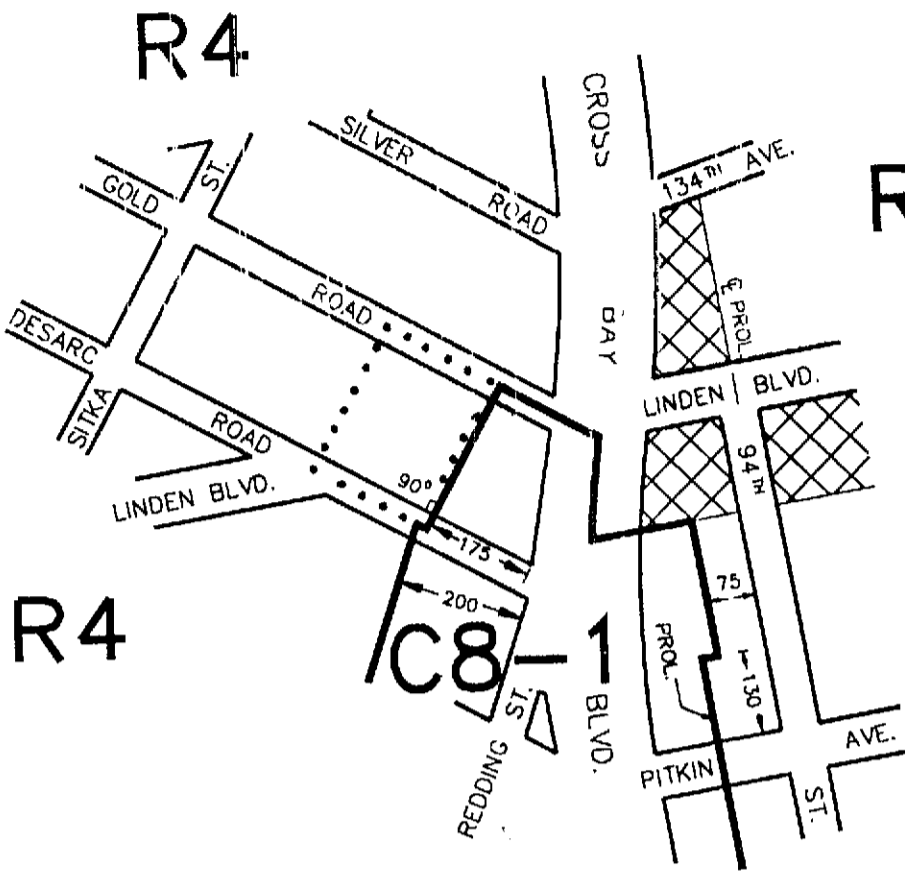

**R4**  
**APPROVED BY CITY COUNCIL**

RES. CALENDAR # 1136  
 DATE 7-18-95  
 date mapped: 9-01-95



NOTE: REFER TO APPLICATION C 890861 MM2 FOR STREET MAPPING CHANGES WITHIN AREA OF THIS PROPOSED ZONING CHANGE.

CITY PLANNING COMMISSION  
 CITY OF NEW YORK

DIAGRAM SHOWING PROPOSED  
**ZONING CHANGE**  
 ON SECTIONAL MAP

**18a**  
 BOROUGH OF  
**QUEENS**

New York, Certification Date  
**JANUARY 30, 1995**

*Sam Paves*  
 Director of Technical Review,  
 Land Use Review Division

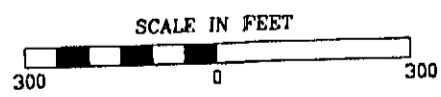

NOTE:

- Indicates Zoning District boundary.
- ..... The area enclosed by the dotted line is proposed to be changed from a C8-1 District to an R4 District.
- ▣ Indicates a C1-2 District.

THIS DIAGRAM IS FOR ILLUSTRATIVE PURPOSES ONLY.

APPROVED BY CITY COUNCIL

CALENDAR # R 1203

DATE 9-6-95  
A 1696

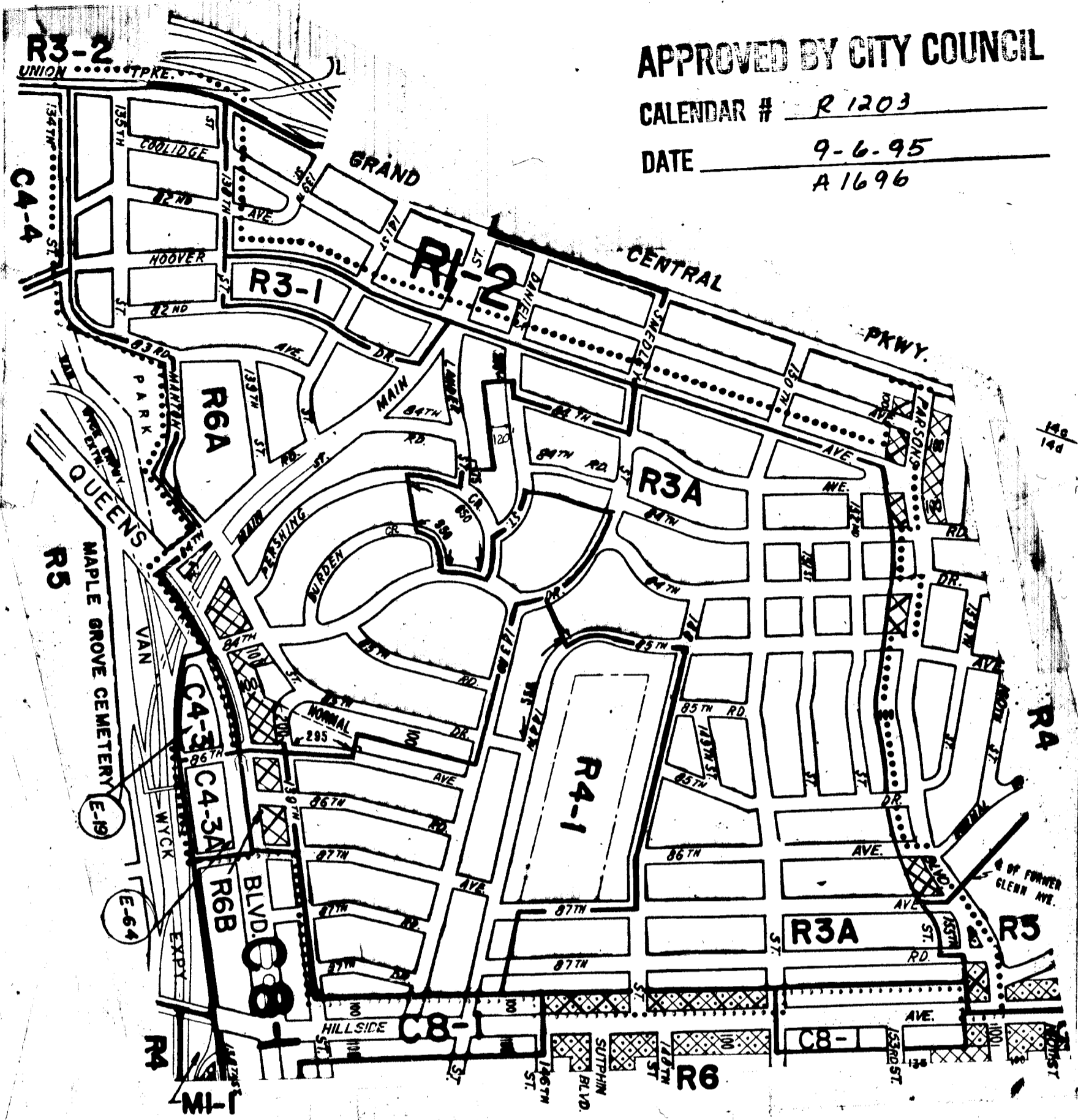

CITY PLANNING COMMISSION  
CITY OF NEW YORK

DIAGRAM SHOWING PROPOSED  
ZONING CHANGE  
ON SECTIONAL MAPS  
14a,b,c&d  
BOROUGH OF  
QUEENS

*[Signature]*  
Director of Technical Review

New York, Certification Date  
March 27, 1995



NOTE:

- Indicates Zoning District Boundary.
  - ..... The area enclosed by the dotted line is proposed to be changed from R4, R5, R6 and C8-1 Districts to R3-1, R3A, R4-1, R6, R6A, R6B and C4-3A Districts and by eliminating C1-2 and C2-2 Districts from existing R4 and R5 Districts, and establishing C1-4 and C2-4 Districts in existing R4 and R5 Districts, and C1-4 and C2-4 Districts in proposed R6, R6A and R6B Districts
  - Indicates a C1-4 District.
  - Indicates a C1-2 District.
  - Indicates a C2-4 District.
  - Indicates a C2-2 District.
  - (E) Indicates a City Environmental Quality Review Declaration, for detail refer to C. E. Q. R. sheet.
- THIS DIAGRAM IS FOR ILLUSTRATIVE PURPOSES ONLY.

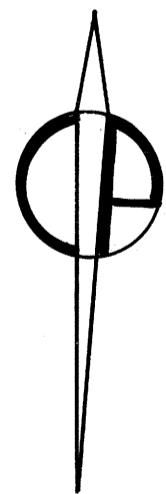
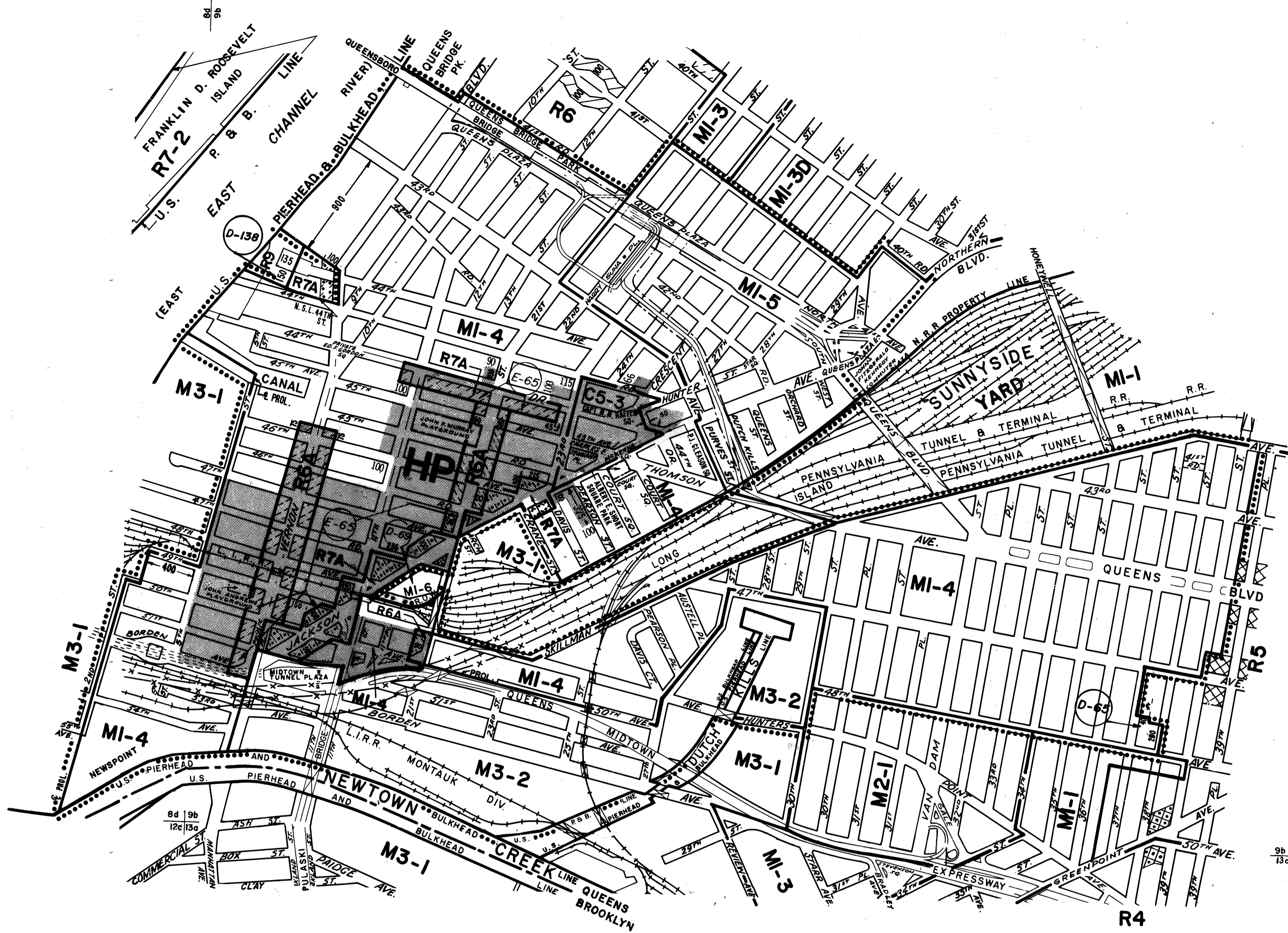

CITY PLANNING COMMISSION  
 CITY OF NEW YORK  
 DIAGRAM SHOWING PROPOSED  
 ZONING CHANGE  
 ON SECTIONAL MAPS

8d, 9b, 12c & 13a  
 BOROUGH OF  
 QUEENS

APPROVED BY CITY COUNCIL  
 CALENDAR # R/317  
 DATE 10-25-95  
 A 16 99

*Sam Puro*  
 DIRECTOR OF TECHNICAL REVIEW

NEW YORK, CERTIFICATION DATE  
 MAY 22, 1995



NOTE:

- Indicates Zoning District boundary.
  - ..... The area enclosed by the dotted line is proposed to be changed from MI-1, MI-2, MI-3, M2-1 and M3-1 Districts, to R6A, R7A, MI-4, MI-5 and M3-2 Districts, by establishing C1-5 Districts in the proposed R6A and R7A Districts and a C2-5 District in the proposed R7A District, and by eliminating a Special Hunters Point Mixed Use District.
  - Indicates a C1-5 District.
  - Indicates a C2-5 District.
  - Indicates a City Environmental Quality Review Declaration, for detail refer to C.E.Q.R. sheet.
  - Indicates a Restrictive Declaration Area, for detail refer to R.D. sheet.
  - Indicates Special Hunters Point Mixed Use District.
- THIS DIAGRAM IS FOR ILLUSTRATIVE PURPOSES ONLY.



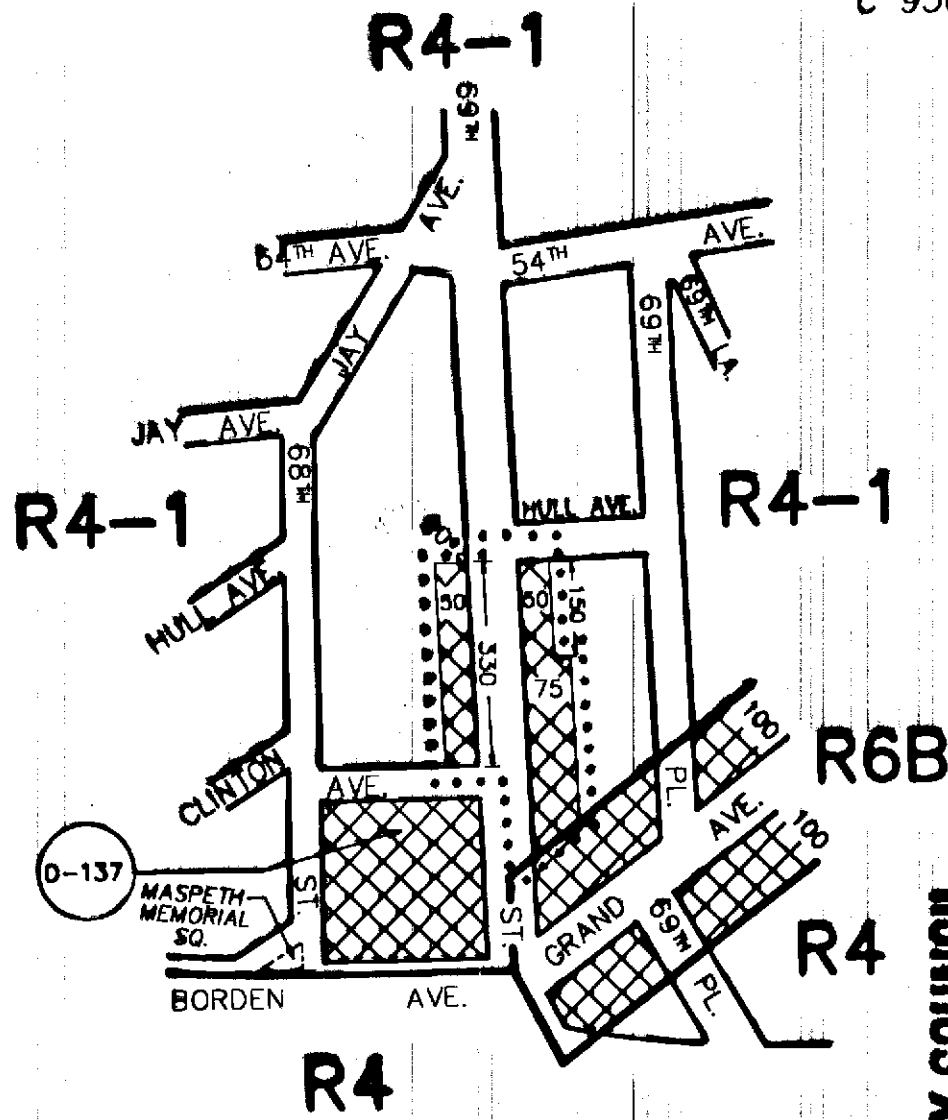

CITY PLANNING COMMISSION  
CITY OF NEW YORK

DIAGRAM SHOWING PROPOSED  
ZONING CHANGE  
ON SECTIONAL MAP

13c  
BOROUGH OF  
QUEENS

APPROVED BY CITY COUNCIL

CALENDAR # R1601

DATE 4-2-96  
A 1710

*[Signature]*  
Director of Technical Review

New York, Certification Date  
OCTOBER 16, 1995  
Modified by City Council  
APRIL 2, 1996

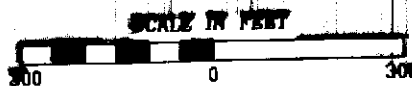

- NOTE:**
- Indicates Zoning District boundary.
  - The area enclosed by the dotted line is proposed to be changed by establishing a C1-2 District within an existing R4-1 District.
  - Indicates a C1-2 District.
  - Indicates a Restrictive Declaration Area, refer to R.D. sheet.

THIS DIAGRAM IS FOR ILLUSTRATIVE PURPOSES ONLY.

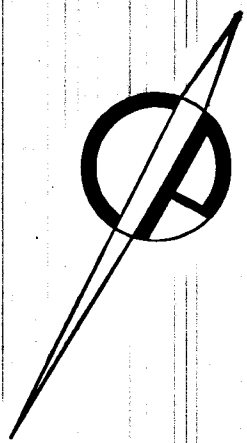
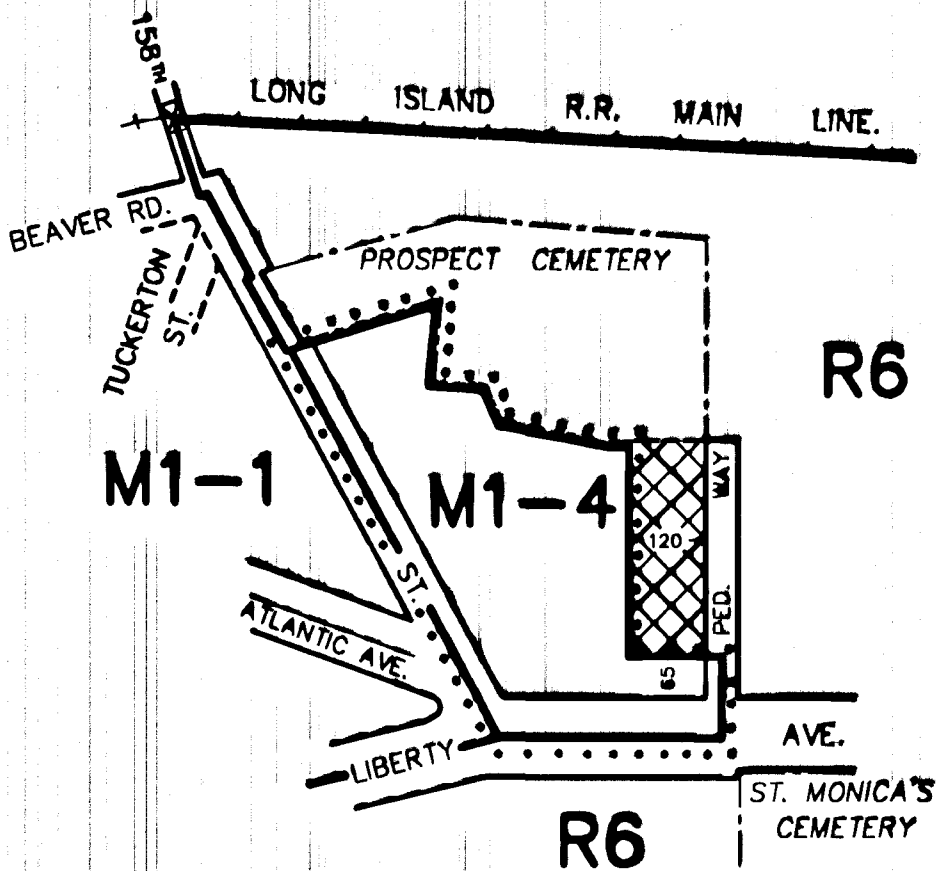

APPROVED BY CITY COUNCIL

CALENDAR # 1806

DATE 6-25-96  
A 1714

CITY PLANNING COMMISSION  
CITY OF NEW YORK

DIAGRAM SHOWING PROPOSED  
ZONING CHANGE  
ON SECTIONAL MAP

14d  
BOROUGH OF  
QUEENS

*Sam Purnas*  
Director of Technical Review

New York, Certification Date  
FEBRUARY 5, 1996

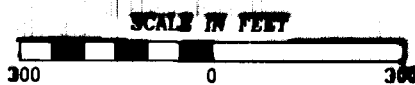

NOTE:

- Indicates Zoning District boundary.
- The area enclosed by the dotted line is proposed to be changed from an R6 District to an M1-4 District and by eliminating a portion of a C1-4 District within the existing R6 District.
- Indicates a C1-4 District.

THIS DIAGRAM IS FOR ILLUSTRATIVE PURPOSES ONLY.



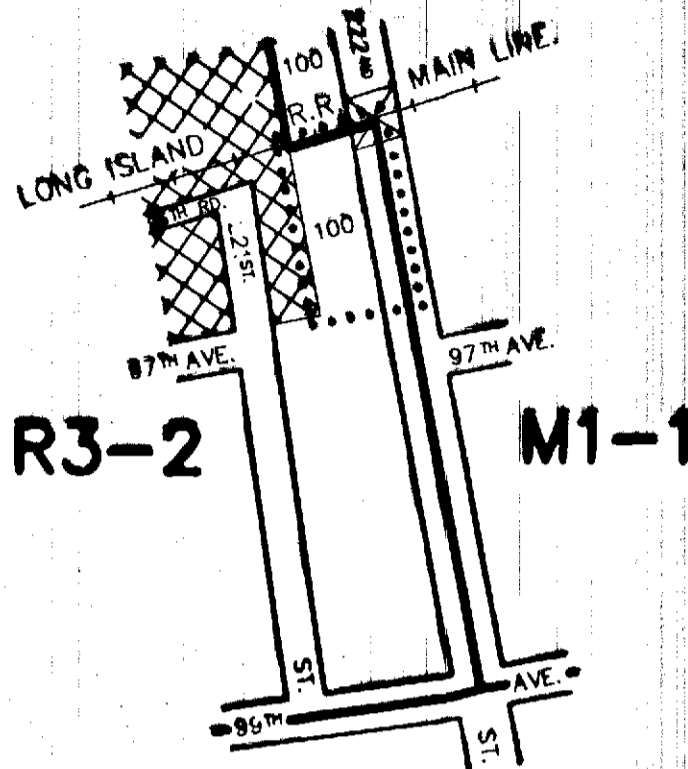

**R2 APPROVED BY CITY COUNCIL**

**RESOLUTION # R 1992**

**DATE 10-30-96**

**A 1721**

**CITY PLANNING COMMISSION  
CITY OF NEW YORK**

**DIAGRAM SHOWING PROPOSED  
ZONING CHANGE  
ON SECTIONAL MAP  
15c  
BOROUGH OF  
QUEENS**

*[Signature]*  
Director of Technical Review

New York, Certification Date  
MAY 20, 1996

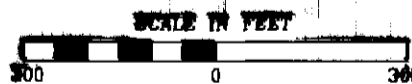

**NOTE:**

- Indicates Zoning District boundary.
- .....** The area enclosed by the dotted line is proposed to be changed from an M1-4 District to an R3-2 District.
- XXXXXX** Indicates a C1-2 District.

**THIS DIAGRAM IS FOR ILLUSTRATIVE PURPOSES ONLY.**

15b  
19a

15b  
19a

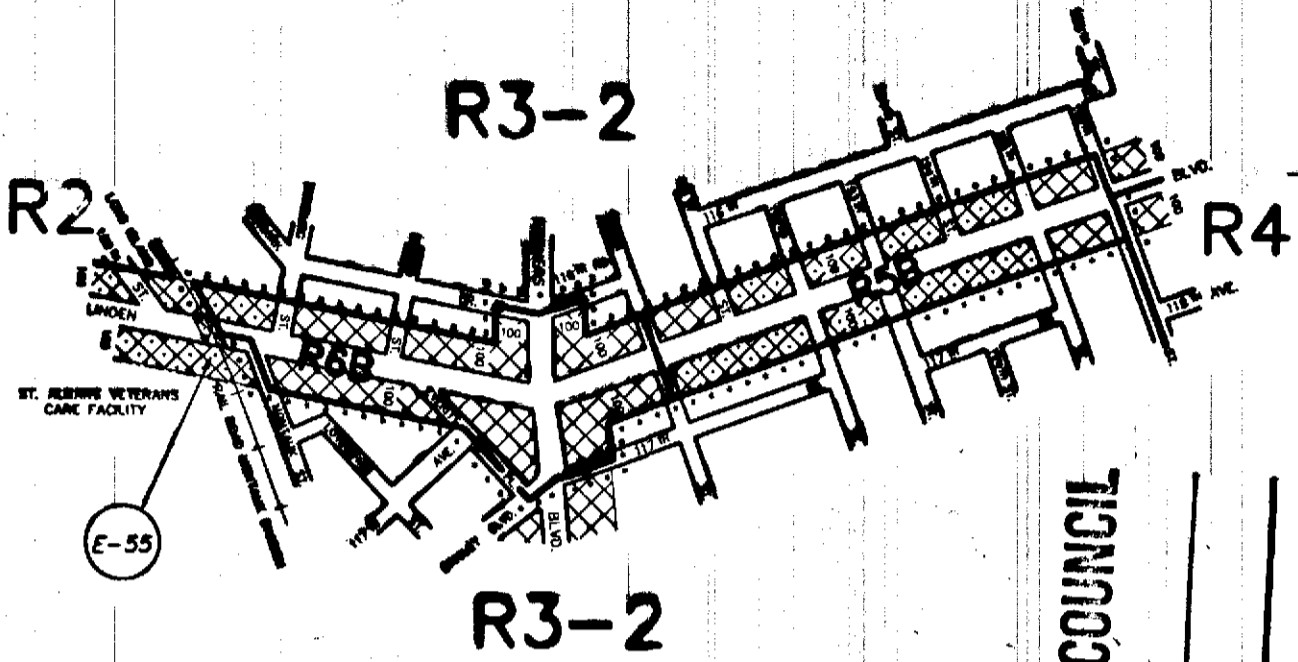

CITY PLANNING COMMISSION  
CITY OF NEW YORK

DIAGRAM SHOWING PROPOSED  
ZONING CHANGE  
ON SECTIONAL MAPS  
15b & 19a  
BOROUGH OF  
QUEENS

APPROVED BY CITY COUNCIL

CALENDAR # 2035

DATE 11-26-96

A.1724

Director of Technical Review

New York, Certification Date  
JUNE 3, 1996

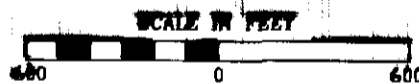

NOTE:

- Indicates Zoning District boundary.
- ..... The area enclosed by the dotted line is proposed to be amended by changing from an R3-2 District to R5B and R6B Districts and by establishing a C1-2 District within the proposed R6B District.
- Indicates a C1-2 District.
- Indicates a C2-2 District.
- Indicates a City Environmental Quality Review Declaration, refer to C.E.Q.R. sheet.

THIS DIAGRAM IS FOR ILLUSTRATIVE PURPOSES ONLY.

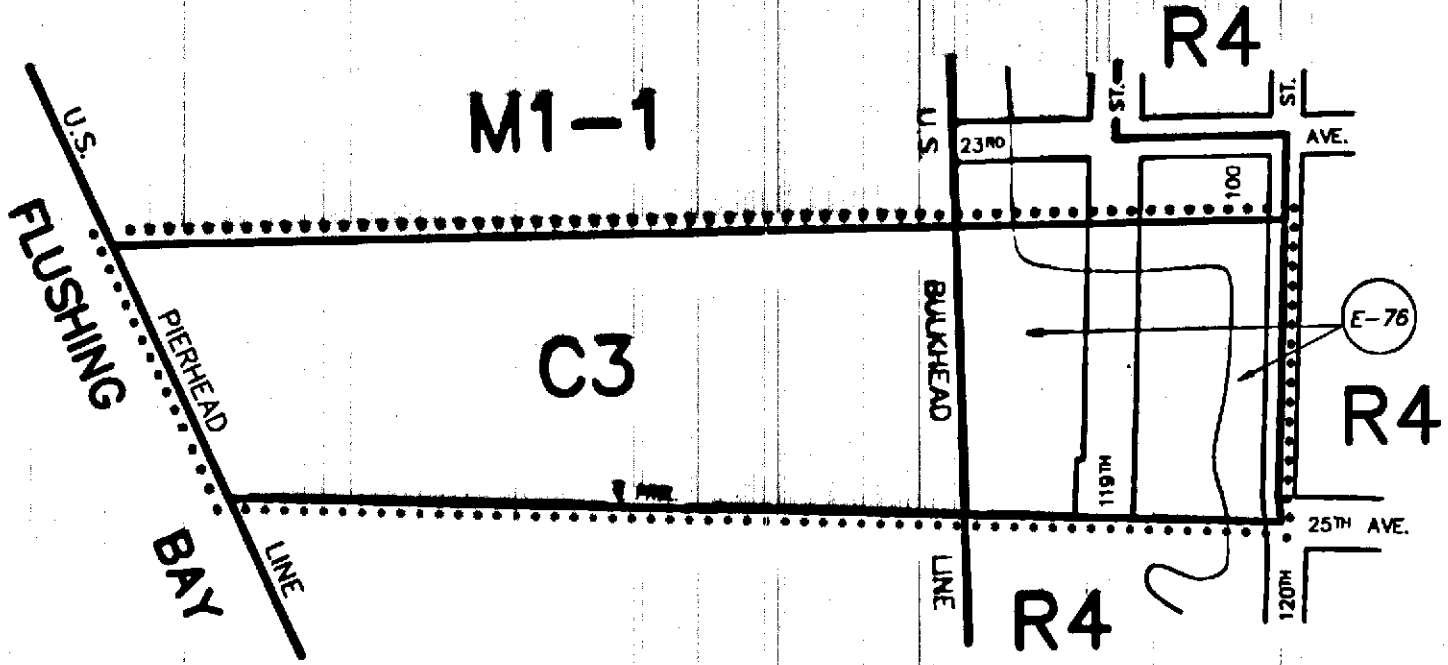

**APPROVED BY CITY COUNCIL**

CALENDAR # R 2040

DATE 11-26-96

A 1726

CITY PLANNING COMMISSION  
CITY OF NEW YORK

**DIAGRAM SHOWING PROPOSED  
ZONING CHANGE  
ON SECTIONAL MAP**

**10a  
BOROUGH OF  
QUEENS**

*Sam Pore*  
Director of Technical Review

New York, Certification Date  
JUNE 17, 1996

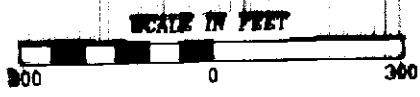

- NOTE:**
- Indicates Zoning District boundary.
  - .....** The area enclosed by the dotted line is proposed to be changed from an M1-1 District to a C3 District.
  - (E)** Indicates a City Environmental Quality Declaration, refer to C.E.Q.R. sheet.

**THIS DIAGRAM IS FOR ILLUSTRATIVE PURPOSES ONLY.**

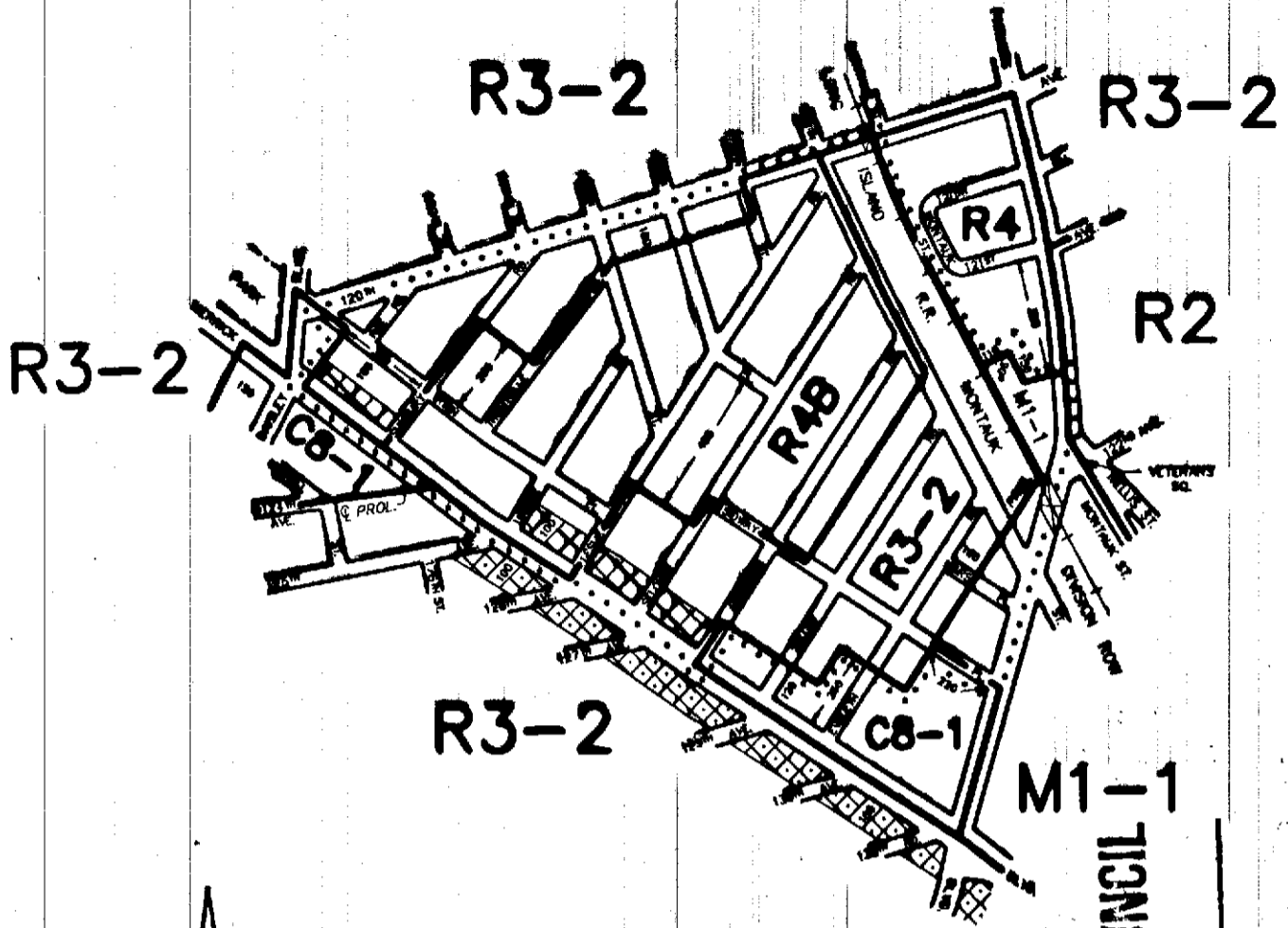

CITY PLANNING COMMISSION  
CITY OF NEW YORK

DIAGRAM SHOWING PROPOSED  
**ZONING CHANGE**  
ON SECTIONAL MAP  
**19a**  
BOROUGH OF  
**QUEENS**

APPROVED BY CITY COUNCIL 1-1

CALENDAR # 2036

DATE 11-26-96

# 1725

New York, Certification Date  
JUNE 3, 1996

Director of Technical Review

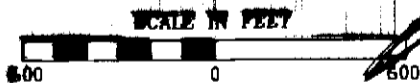

*[Handwritten signature]*

**NOTE:**

- Indicates Zoning District boundary.
- ..... The area enclosed by the dotted line is proposed to be amended by changing R4 and C8-1 Districts to R3-2, R4B and M1-1 Districts, by eliminating C1-2 Districts from the existing R4 District, and establishing C1-4 Districts within the proposed R3-2 and R4B Districts.



Indicates a C1-4 District.



Indicates a C2-2 District.

THIS DIAGRAM IS FOR ILLUSTRATIVE PURPOSES ONLY.

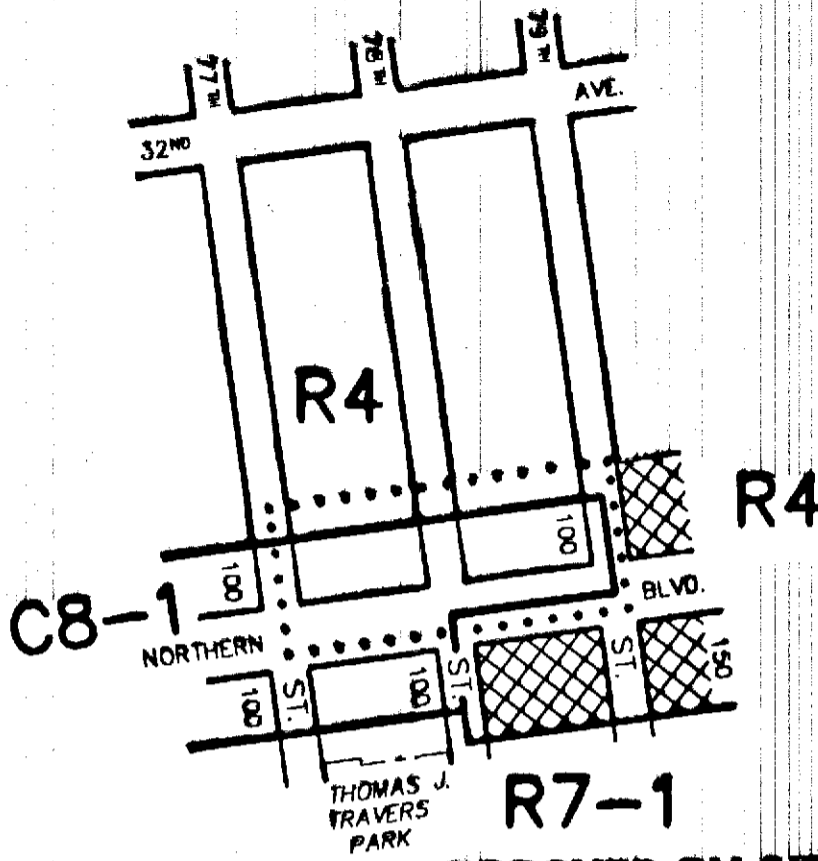

**APPROVED BY CITY COUNCIL**

**CALENDAR #** R 2575

**DATE** 9-18-97  
A 1738

**CITY PLANNING COMMISSION**  
**CITY OF NEW YORK**



**DIAGRAM SHOWING PROPOSED  
ZONING CHANGE  
ON SECTIONAL MAP**

**9d**  
**BOROUGH OF  
QUEENS**

*[Signature]*  
Director of Technical Review

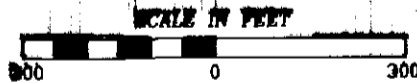
New York, Certification Date  
MARCH 17, 1997



- NOTE:**
-  Indicates Zoning District boundary.
  -  The area enclosed by the dotted line is proposed to be changed from an R4 District to a C8-1 District and by eliminating a C1-2 District from an existing R4 District.
  -  Indicates a C1-2 District.

**THIS DIAGRAM IS FOR ILLUSTRATIVE PURPOSES ONLY.**

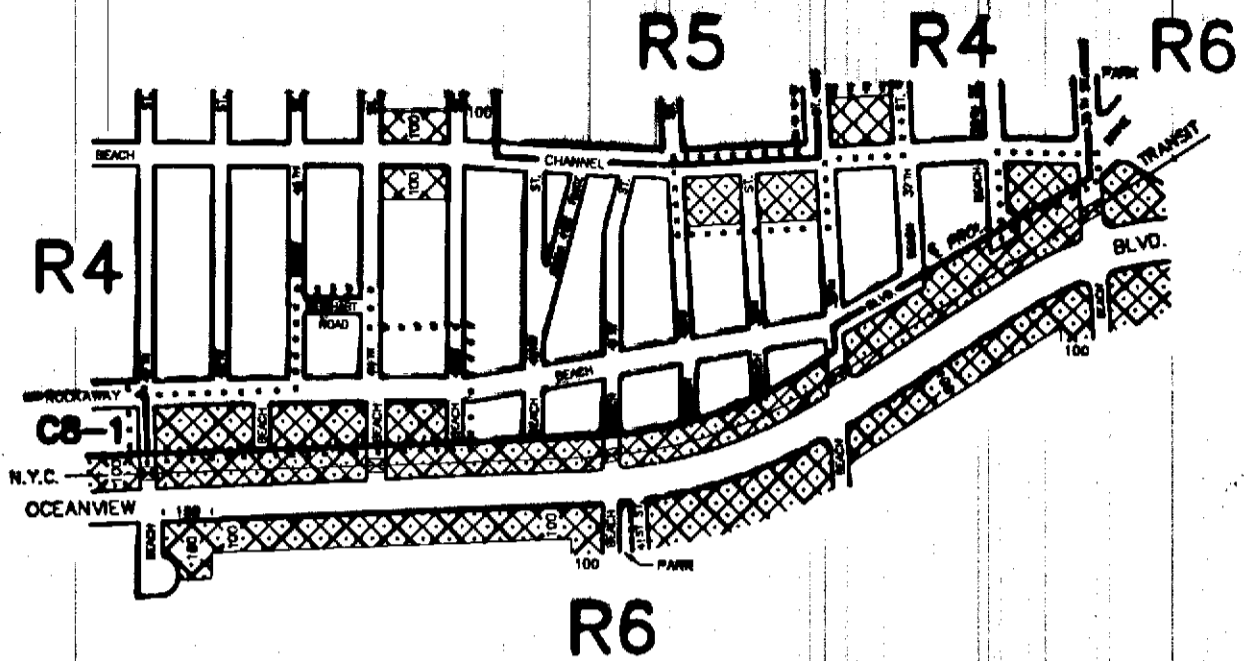

**APPROVED BY CITY COUNCIL**

CALENDAR # 2579

DATE 9-18-97  
A 1740

**NOTE:** REFER TO ALTERATION MAP C950223 MMQ FOR RELATED PROPOSED STREET MAPPING CHANGES IN THE AREA OF THIS PROPOSED ZONING CHANGE.



CITY PLANNING COMMISSION  
CITY OF NEW YORK



DIAGRAM SHOWING PROPOSED  
**ZONING CHANGE**  
ON SECTIONAL MAP  
**31a**  
BOROUGH OF  
**QUEENS**

*[Signature]*  
Director of Technical Review

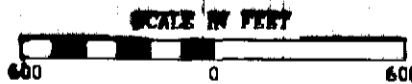
New York, Certification Date  
MARCH 17, 1997



**NOTE:**

- Indicates Zoning District boundary.
- ..... The areas enclosed by the dotted lines are proposed to be changed by eliminating a C1-2 District and establishing C1-2, C2-2 and C2-4 Districts within an existing R4 District.
-  Indicates a C1-2 District.
-  Indicates a C2-2 District.
-  Indicates a C2-4 District.

**THIS DIAGRAM IS FOR ILLUSTRATIVE PURPOSES ONLY.**

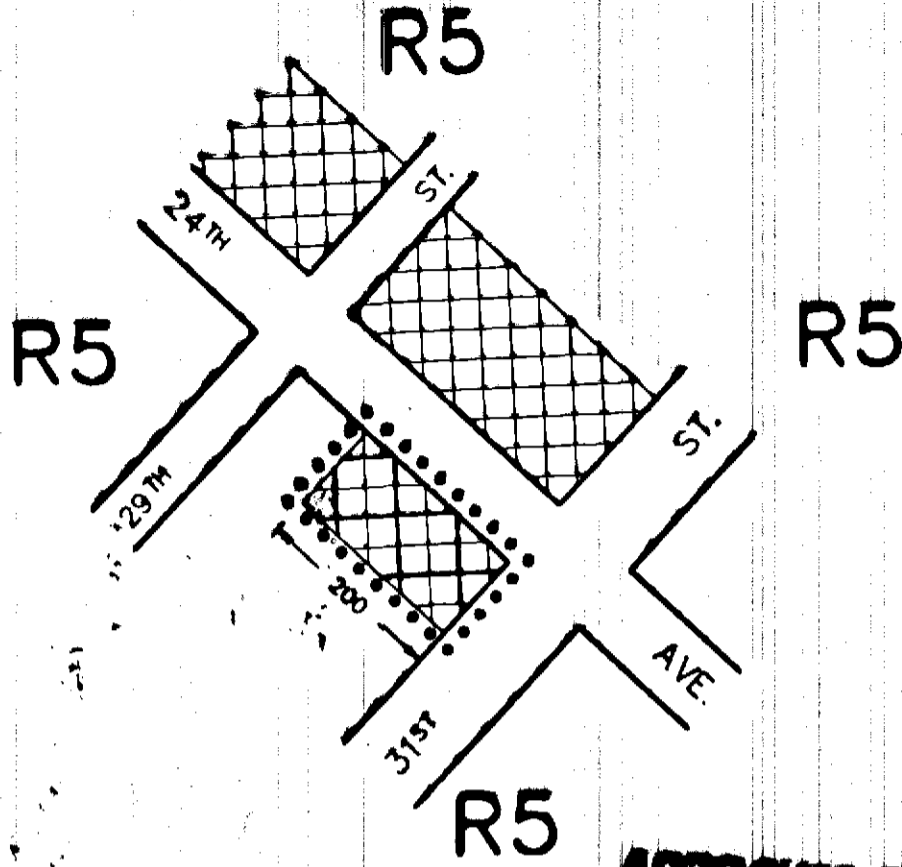

APPROVED BY CITY COUNCIL

RESOLUTION # R 2643

DATE 10-14-97  
A 1745



CITY PLANNING COMMISSION  
CITY OF NEW YORK

DIAGRAM SHOWING PROPOSED  
ZONING CHANGE  
ON SECTIONAL MAP



9a  
BOROUGH OF  
QUEENS

Director of Technical Review

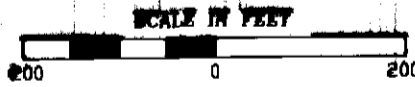
New York, Certification Date  
JUNE 16, 1997



NOTE:

- The area enclosed by the dotted line is proposed to be changed by establishing a C1-4 District within an existing R5 District.
-  Indicates a C1-2 District.
-  Indicates a C1-4 District.

THIS DIAGRAM IS FOR ILLUSTRATIVE PURPOSES ONLY.

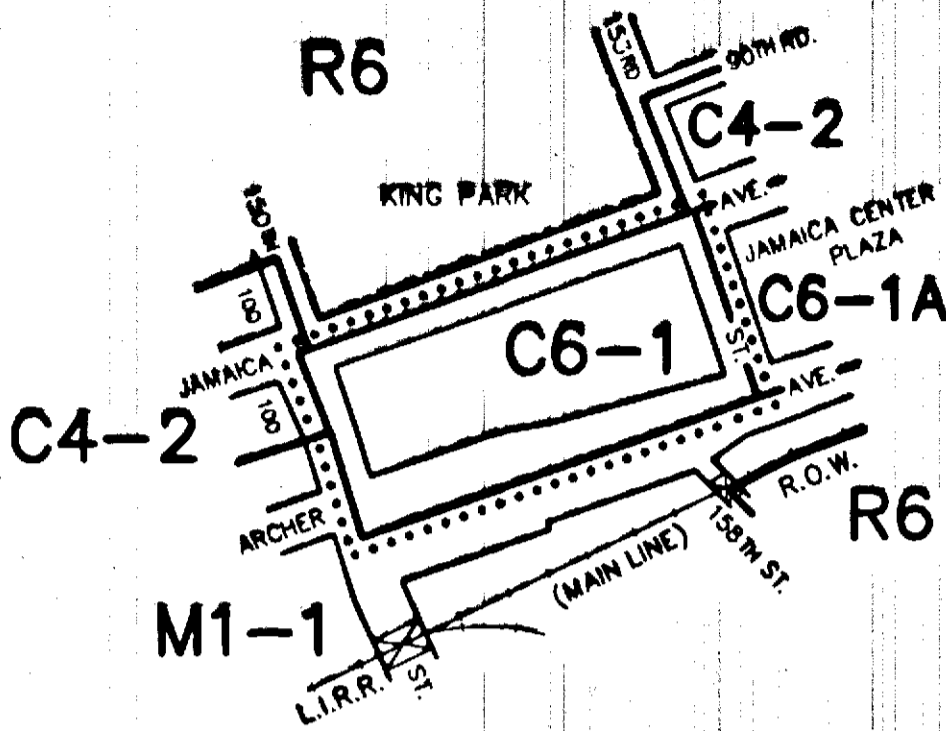

**APPROVED BY CITY COUNCIL**

**ORDINANCE #** R 2664

**DATE** 10-29-97  
A 1746



CITY PLANNING COMMISSION  
CITY OF NEW YORK

DIAGRAM SHOWING PROPOSED  
**ZONING CHANGE**  
ON SECTIONAL MAP

**14d**  
BOROUGH OF  
**QUEENS**

*[Signature]*  
Director of Technical Review

New York, Certification Date  
JUNE 16, 1997

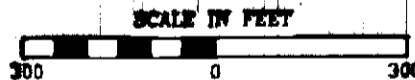

- NOTE:**
- Indicates Zoning District boundary.
  - ..... The area enclosed by the dotted line is proposed to be changed from a C6-1A District to a C6-1 District.

**THIS DIAGRAM IS FOR ILLUSTRATIVE PURPOSES ONLY.**



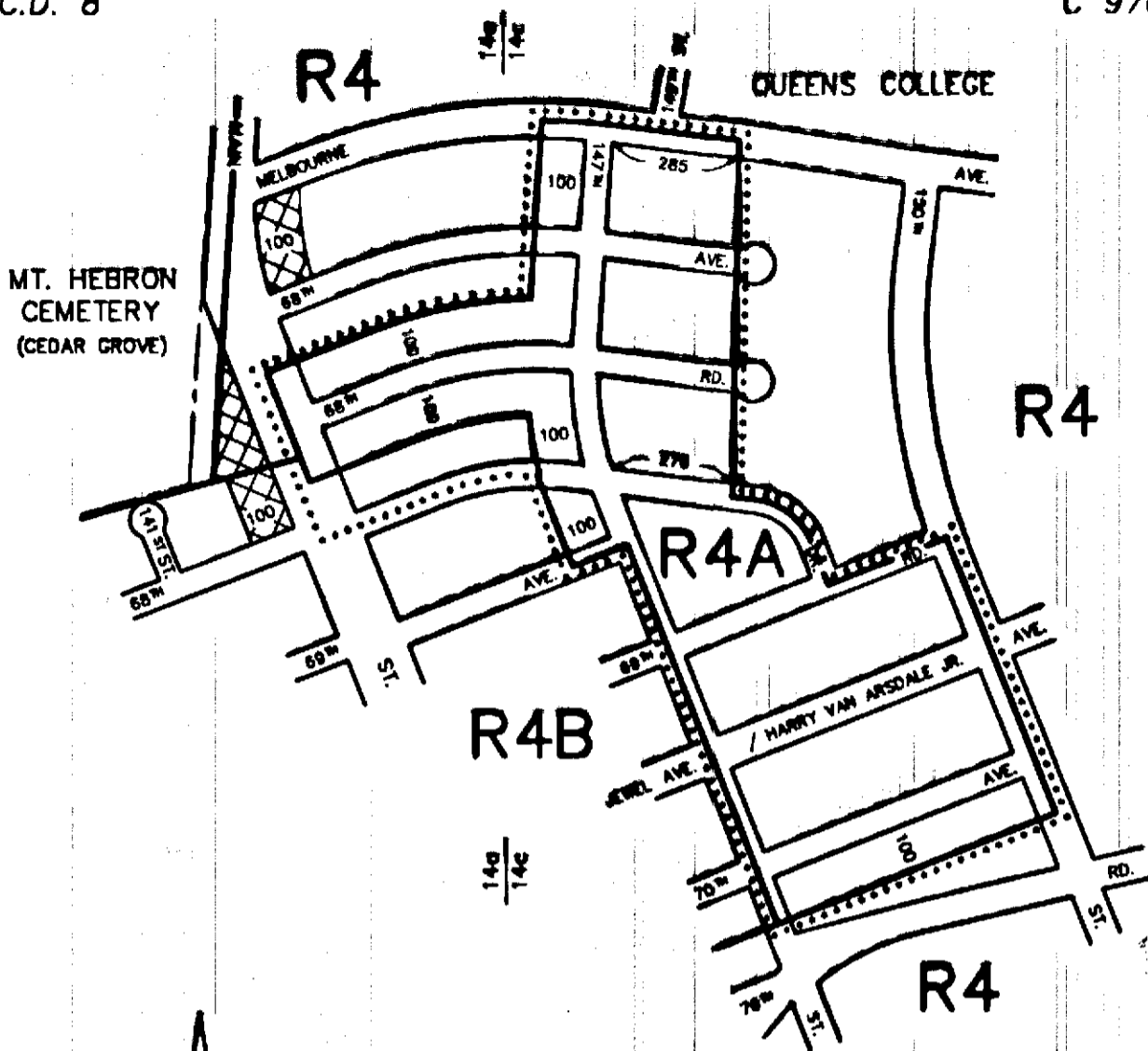

CITY PLANNING COMMISSION  
 CITY OF NEW YORK  
 DIAGRAM SHOWING PROPOSED  
 ZONING CHANGE  
 ON SECTIONAL MAPS  
 14a & 14c  
 BOROUGH OF  
 QUEENS

APPROVED BY CITY COUNCIL  
 CALENDAR # R 159  
 DATE 3-18-98

*[Signature]*  
 Director of Technical Review

New York, Certification Date  
 OCTOBER 20, 1997

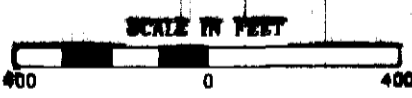

- NOTE:**
- Indicates Zoning District boundary.
  - ..... The area enclosed by the dotted line is proposed to be changed from an R4 District to R4A and R4B Districts.
  - ▨ Indicates a C1-2 District.

THIS DIAGRAM IS FOR ILLUSTRATIVE PURPOSES ONLY.

CITY PLANNING COMMISSION  
CITY OF NEW YORK

DIAGRAM SHOWING PROPOSED  
ZONING CHANGE  
ON SECTIONAL MAPS  
9a & 9b  
BOROUGH OF  
QUEENS

*[Signature]*  
Director of Technical Review

New York, Certification Date  
DECEMBER 1, 1997

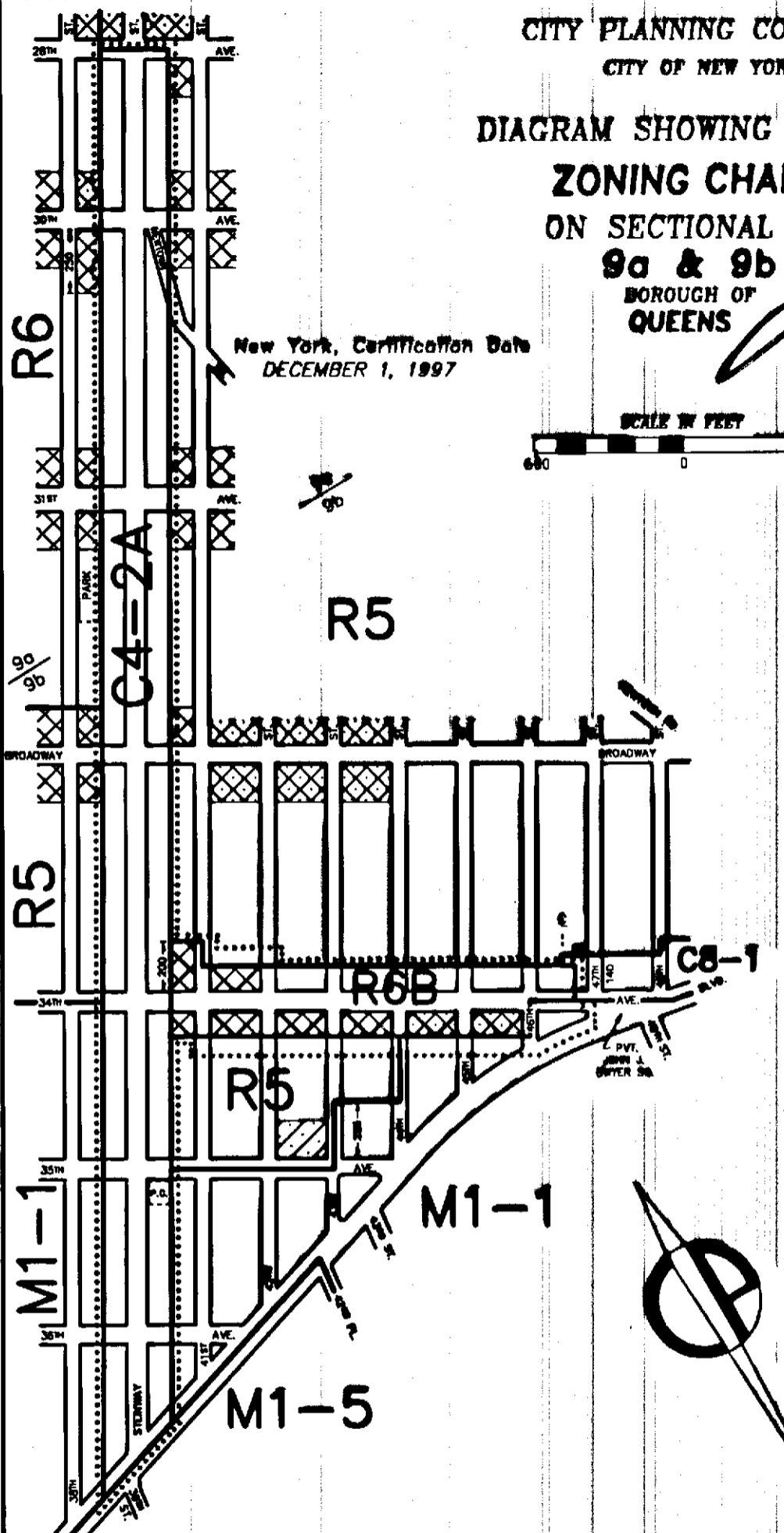
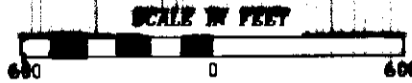

APPROVED BY CITY COUNCIL

CALENDAR # 235  
DATE 4-28-98  
A-1753

NOTE:

..... Indicates Zoning District boundary.

The area enclosed by the dotted lines is proposed to be changed by eliminating from an existing R5 District, C1-2 and C2-1 Districts, changing from an R5, C4-2 and M1-1 Districts to R5B, C4-2A and M1-1 Districts, and by establishing a C1-4 and C2-4 Districts within the proposed R5B District.

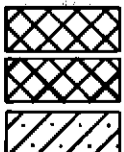

Indicates a C1-2 District.  
Indicates a C1-4 District.  
Indicates a C2-1 District.



Indicates a C2-2 District.  
Indicates a C2-4 District.

THIS DIAGRAM IS FOR ILLUSTRATIVE PURPOSES ONLY.

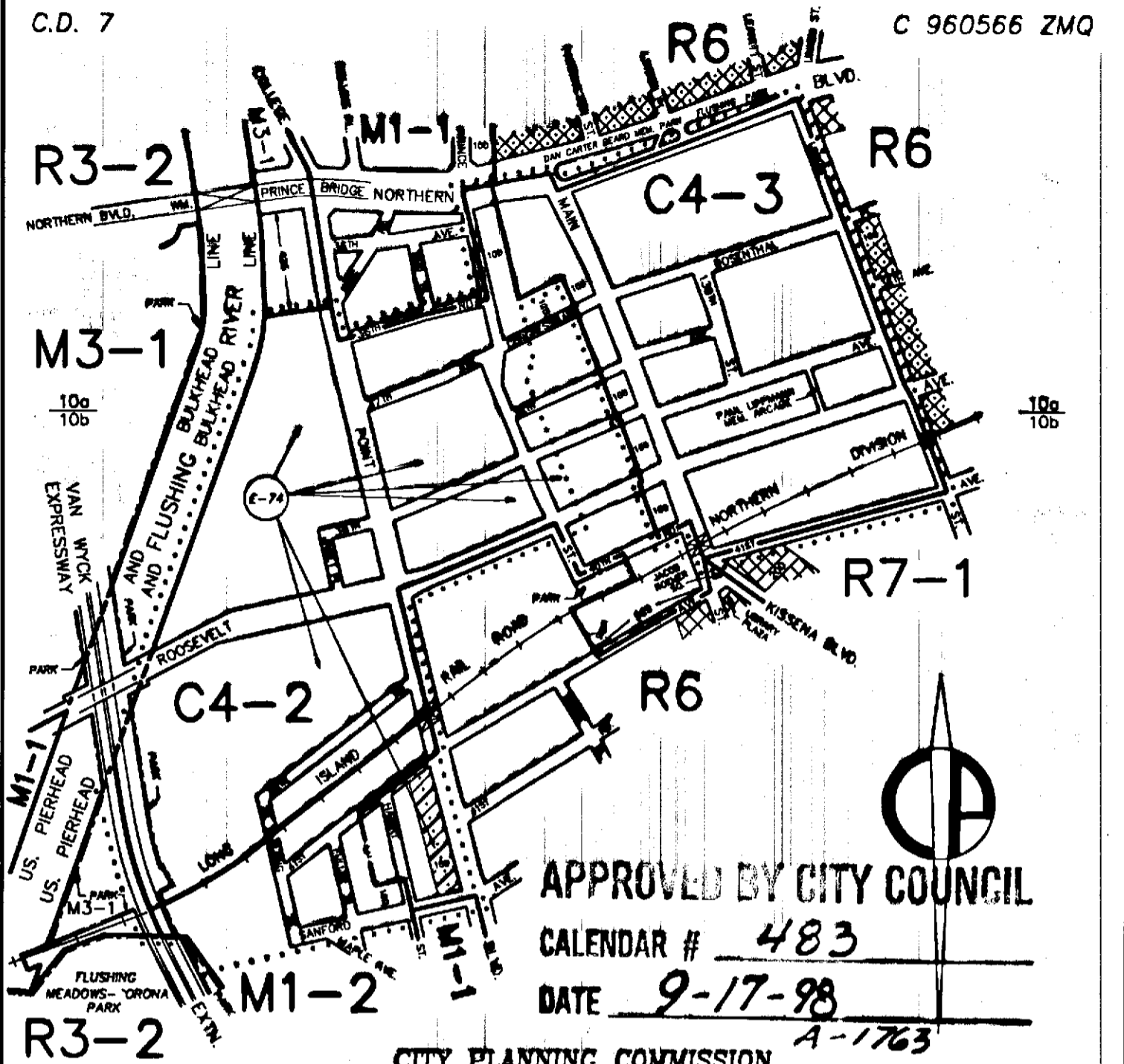

APPROVED BY CITY COUNCIL

CALENDAR # 483

DATE 9-17-98

A-1763

CITY PLANNING COMMISSION  
CITY OF NEW YORK

DIAGRAM SHOWING PROPOSED  
ZONING CHANGE  
ON SECTIONAL MAPS  
10a & 10b  
BOROUGH OF  
QUEENS

*[Signature]*  
Director of Technical Review

New York, Certification Date  
APRIL 13, 1998  
Revised  
MAY 29, 1998

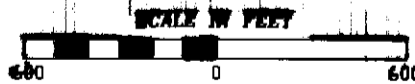

NOTE:

- Indicates Zoning District boundary.
- ..... The area enclosed by the dotted line is proposed to be changed by changing M1-1, M3-1 and C4-2 Districts to C4-2, C4-3, M1-2 and R6 Districts and by establishing a C2-3 District within a proposed R6 District.
- Indicates a C1-2 District.
- Indicates a C2-2 District.
- Indicates a C2-3 District.
- Indicates a City Environmental Quality Review Declaration, refer to C.E.Q.R. sheet.

THIS DIAGRAM IS FOR ILLUSTRATIVE PURPOSES ONLY.

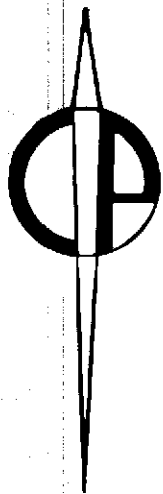
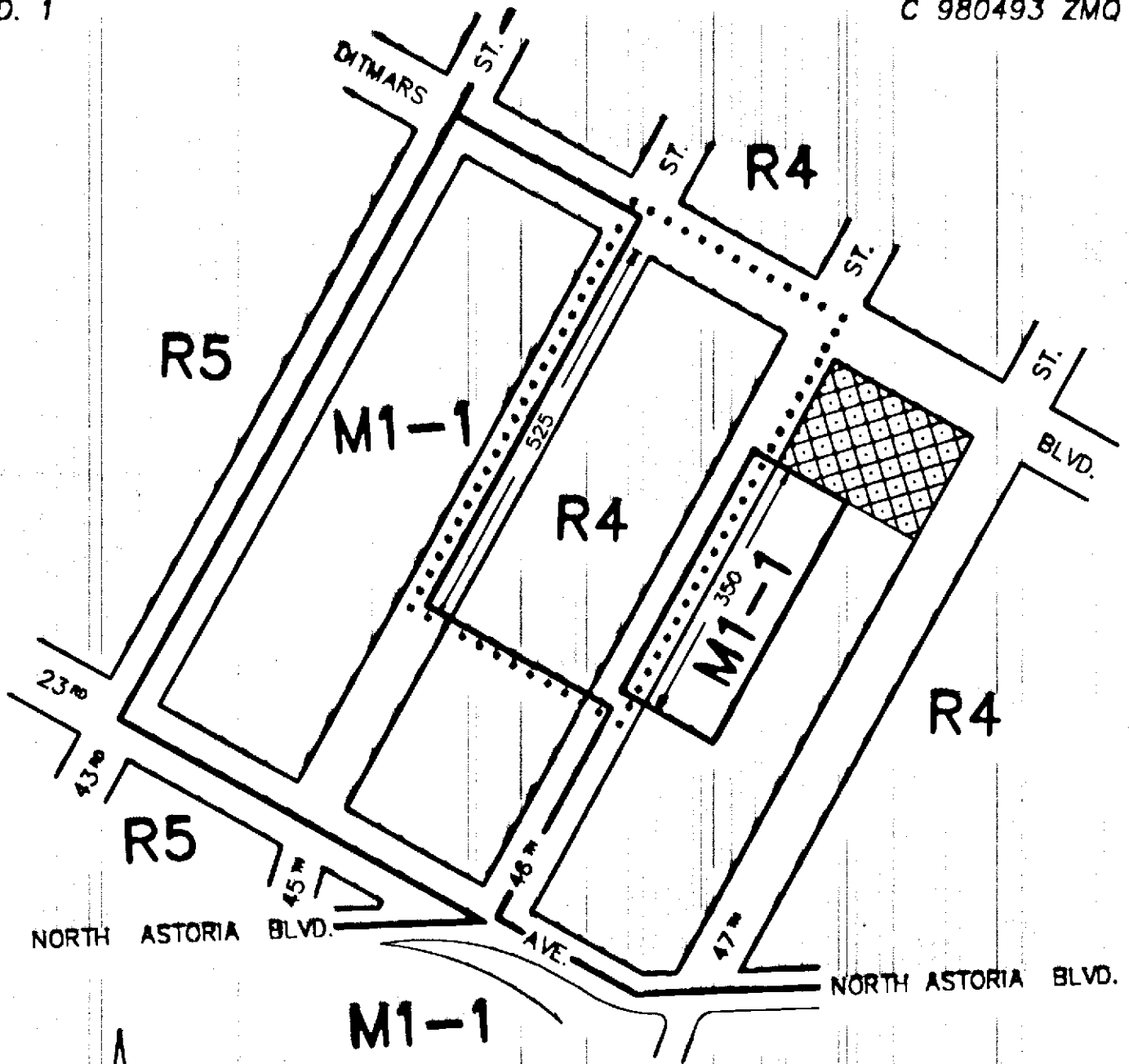

CITY PLANNING COMMISSION  
CITY OF NEW YORK

DIAGRAM SHOWING PROPOSED  
**ZONING CHANGE**  
ON SECTIONAL MAP



**9c**  
BOROUGH OF  
QUEENS

*[Signature]*  
Director of Technical Review

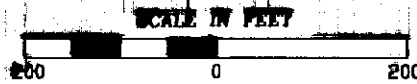
New York, Certification Date  
APRIL 27, 1998



**NOTE:**

-  Indicates Zoning District Boundary.
-  The area enclosed by the dotted line is proposed to be changed from an M1-1 District to an R4 District.
-  Indicates a C2-2 District.

THIS DIAGRAM IS FOR ILLUSTRATIVE PURPOSES ONLY.

CALENDAR # 514

DATE 10-22-98

A-1764

CITY COUNCIL

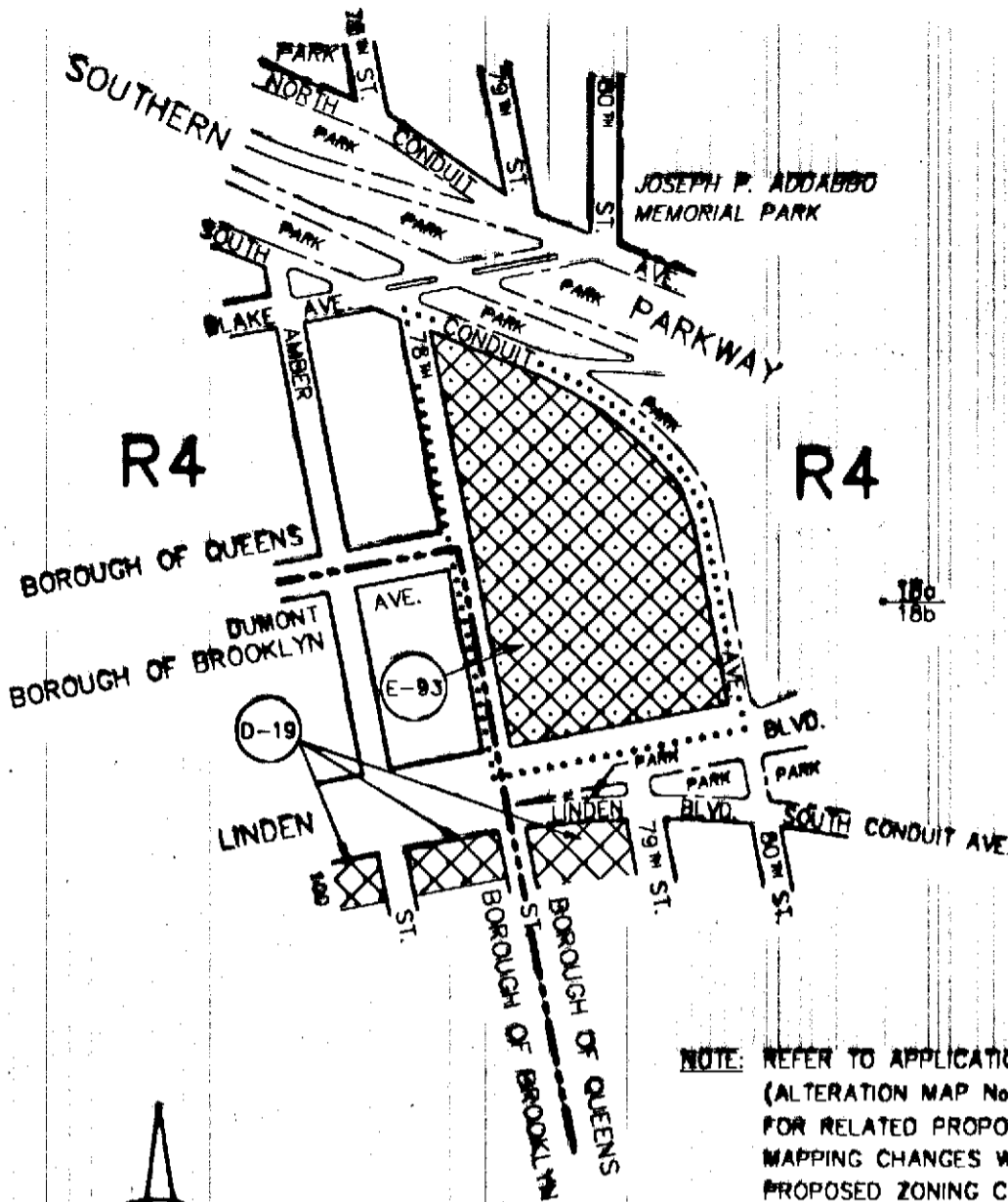

APPROVED BY CITY COUNCIL

RESOLUTION # 887  
CALENDAR #

DATE 6-30-99  
A-1774

NOTE: REFER TO APPLICATION C910331 MMQ  
(ALTERATION MAP No. 4908)  
FOR RELATED PROPOSED STREET  
MAPPING CHANGES WITHIN AREA OF THIS  
PROPOSED ZONING CHANGE.



CITY PLANNING COMMISSION  
CITY OF NEW YORK



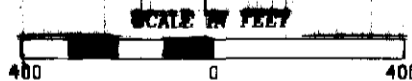

DIAGRAM SHOWING PROPOSED  
ZONING CHANGE  
ON SECTIONAL MAPS  
18a & 18b  
BOROUGH OF  
QUEENS

New York, Certification Date  
FEBRUARY 8, 1999

*[Signature]*  
Director of Technical Review



NOTE:

- ..... The area enclosed by the dotted line is proposed to be changed by establishing within the existing R4 District an C2-2 District.
-  Indicates a C1-2 District.
-  Indicates a C2-2 District.
-  Indicates a Restrictive Declaration Area, refer to R.D. sheet.
-  Indicates a City Environmental Quality Review Declaration, refer to C.E.Q.R. sheet.

THIS DIAGRAM IS FOR ILLUSTRATIVE PURPOSES ONLY.

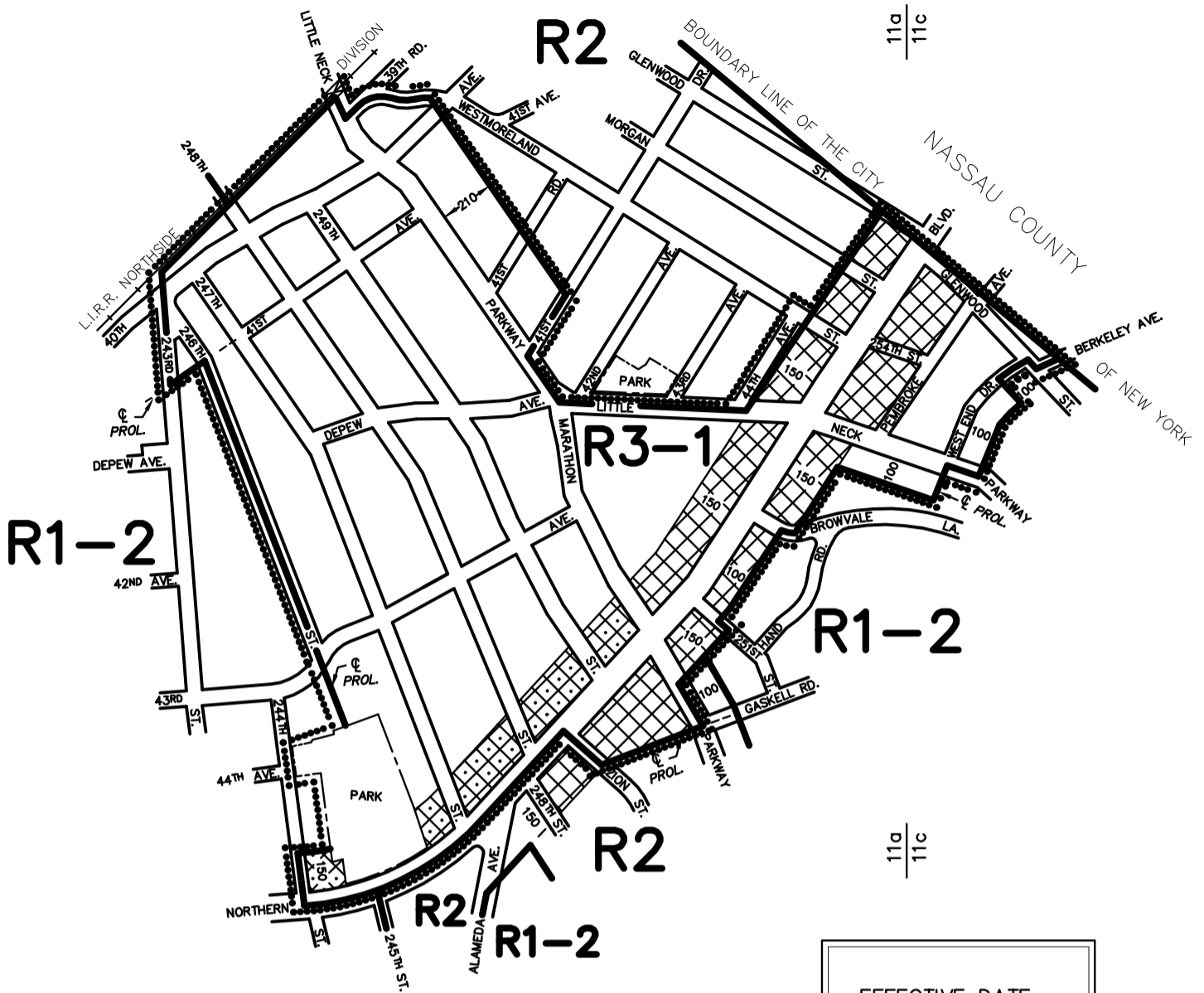

11a  
11c

11a  
11c

EFFECTIVE DATE:  
**March 29, 2000**  
 C. C. RESO. # 1282

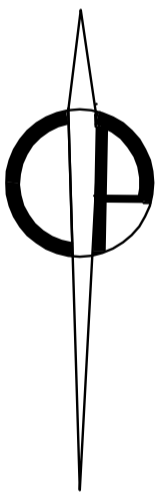

CITY PLANNING COMMISSION  
 CITY OF NEW YORK

DIAGRAM SHOWING  
**ZONING CHANGE**  
 ON SECTIONAL MAPS  
**11a & 11c**  
 BOROUGH OF  
**QUEENS**

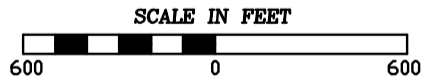

- NOTE:**
- Indicates Zoning District boundary.
  - The area enclosed by the dotted line is rezoned by changing an R3-2 District to an R3-1 District.
  - Indicates a C1-2 District.
  - Indicates a C2-2 District.

THIS DIAGRAM IS FOR ILLUSTRATIVE PURPOSES ONLY.

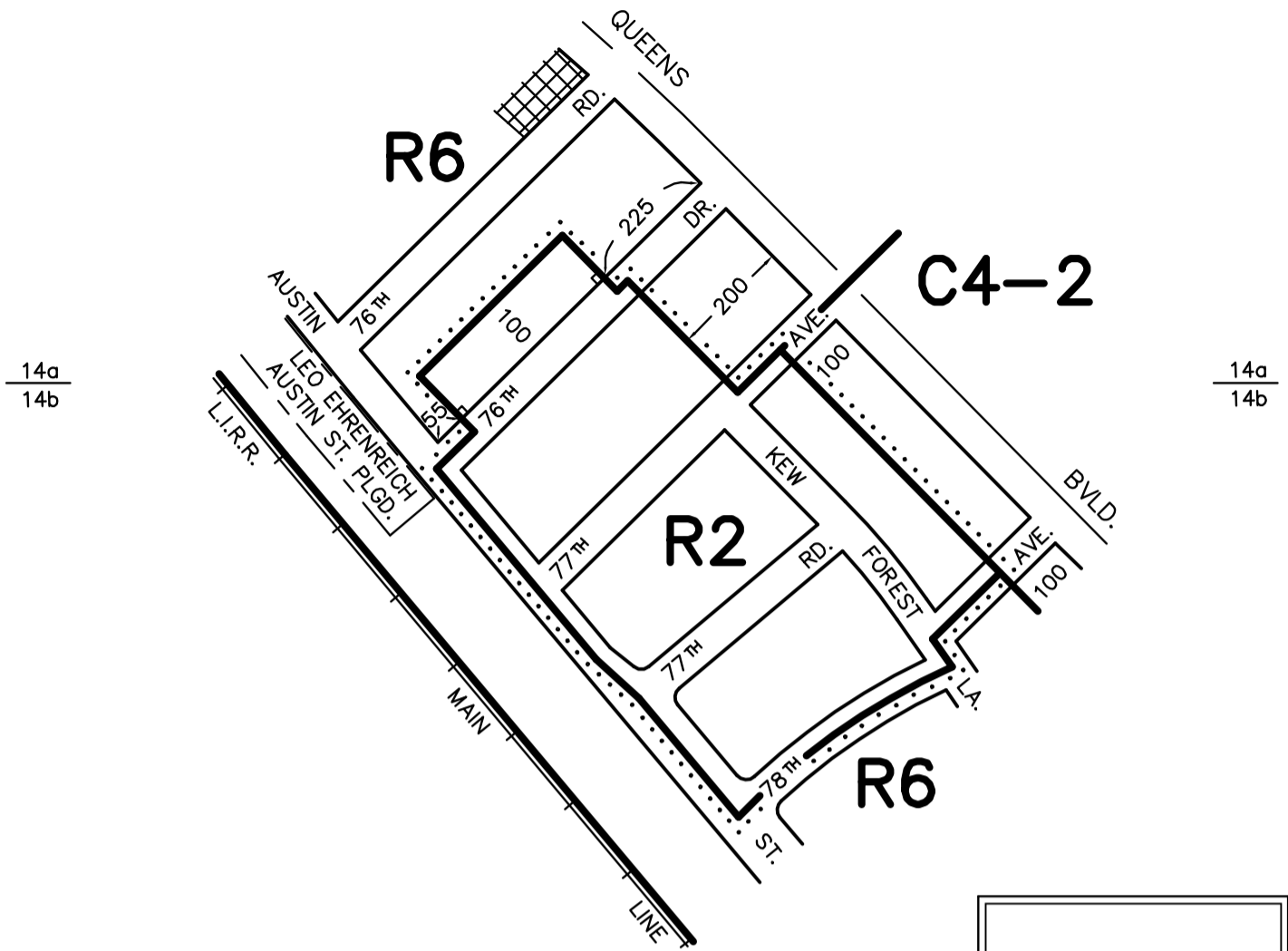

14a  
14b

14a  
14b

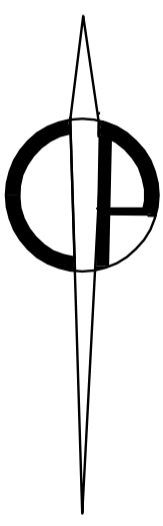

EFFECTIVE DATE:  
**March 29, 2000**  
 C. C. RESO. # 1283

CITY PLANNING COMMISSION  
 CITY OF NEW YORK

DIAGRAM SHOWING  
**ZONING CHANGE**  
 ON SECTIONAL MAPS  
**14a & 14b**  
 BOROUGH OF  
**QUEENS**

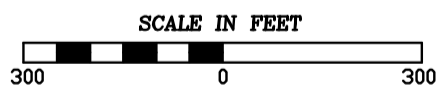

- NOTE:**
- Indicates Zoning District boundary.
  - The area enclosed by the dotted line is rezoned by changing an R6 District to an R2 District.
  - Indicates a C1-2 District.

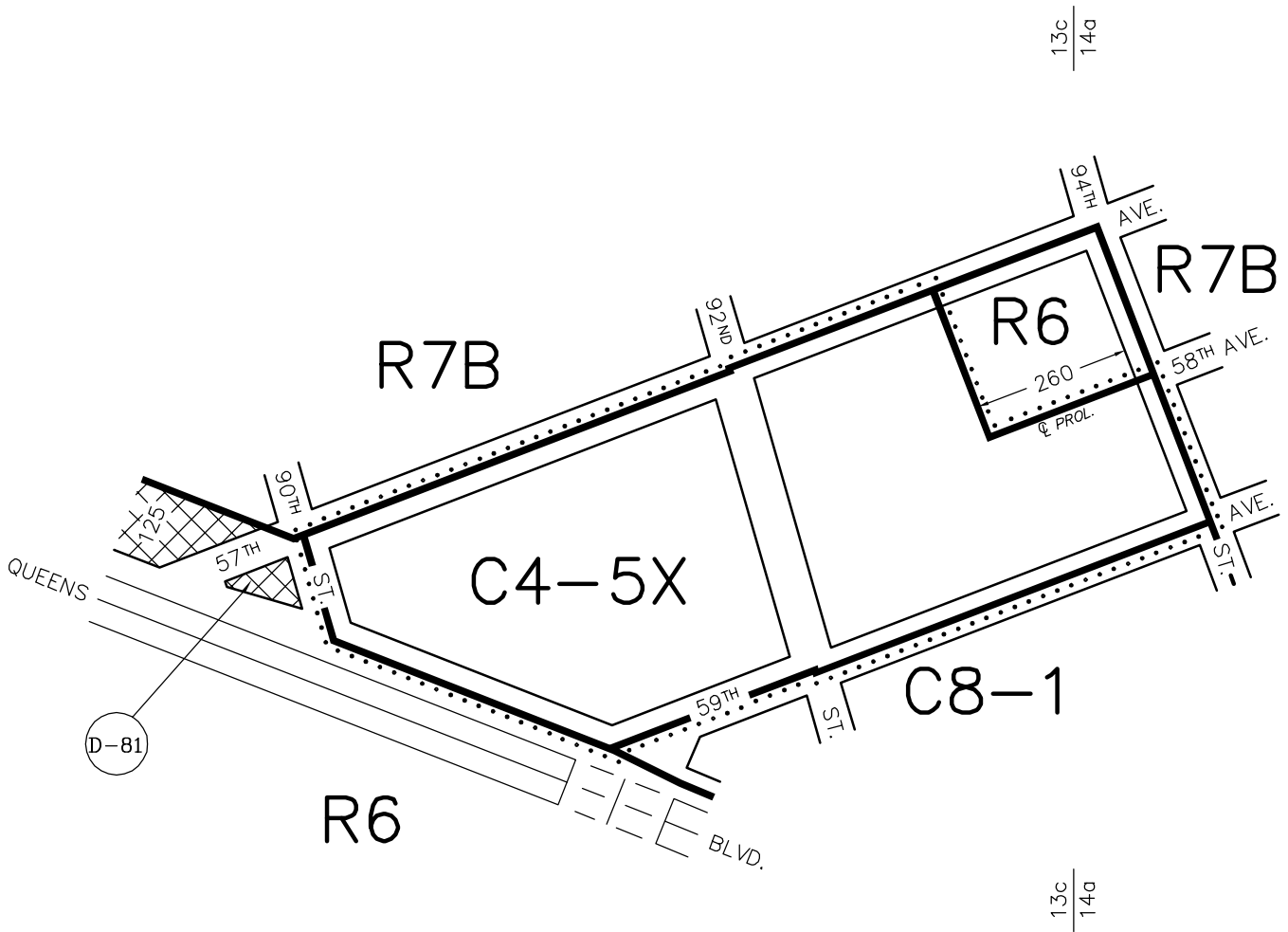

NOTE: REFER TO APPLICATION MAP C990666 MMQ FOR RELATED PROPOSED STREET MAPPING CHANGES WITHIN AREA OF THIS PROPOSED ZONING CHANGE.

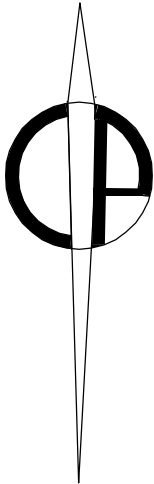



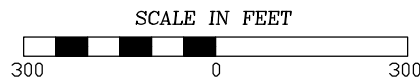

CITY PLANNING COMMISSION  
CITY OF NEW YORK

DIAGRAM SHOWING  
**ZONING CHANGE**  
ON SECTIONAL MAPS  
**13c & 14a**  
BOROUGH OF  
**QUEENS**

EFFECTIVE DATE:  
**June 28, 2000**  
C. C. RESO. # 1446



**NOTE:**

-  Indicates Zoning District boundary.
-  The area enclosed by the dotted line is rezoned by changing C4-2, C8-1 and R6 Districts to a C4-5X District.
-  Indicates a C1-2 District.
-  Indicates a Restrictive Declaration Area, refer to R.D. sheet.

THIS DIAGRAM IS FOR ILLUSTRATIVE PURPOSES ONLY.



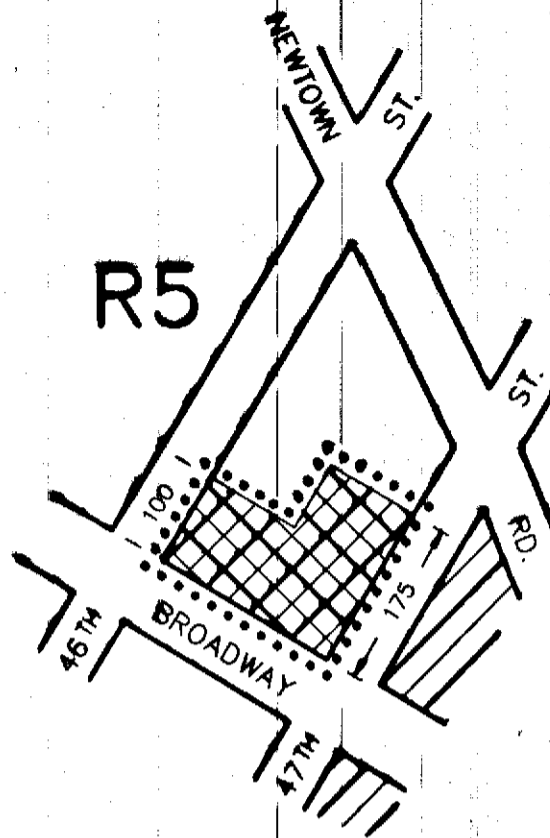

**APPROVED BY CITY COUNCIL**

**CALENDAR #** 1596

**DATE** 10-12-00  
A-1800

**CITY PLANNING COMMISSION  
CITY OF NEW YORK**

**DIAGRAM SHOWING PROPOSED  
ZONING CHANGE  
ON SECTIONAL MAP  
9b**

**BOROUGH OF  
QUEENS**

New York, Certification Date  
**JUNE 26, 2000**  
Modified  
**SEPTEMBER 5, 2000**

*Director of Technical Review*

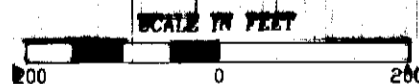

**NOTE:**

..... The area enclosed by the dotted line is proposed to be changed by establishing a C1-4 District within the existing R5 District.

 Indicates a C1-3 District.

 Indicates a C1-4 District.

THIS DIAGRAM IS FOR ILLUSTRATIVE PURPOSES ONLY.

**APPROVED BY CITY COUNCIL**

**CALENDAR #** 1596

**DATE** 10-12-00

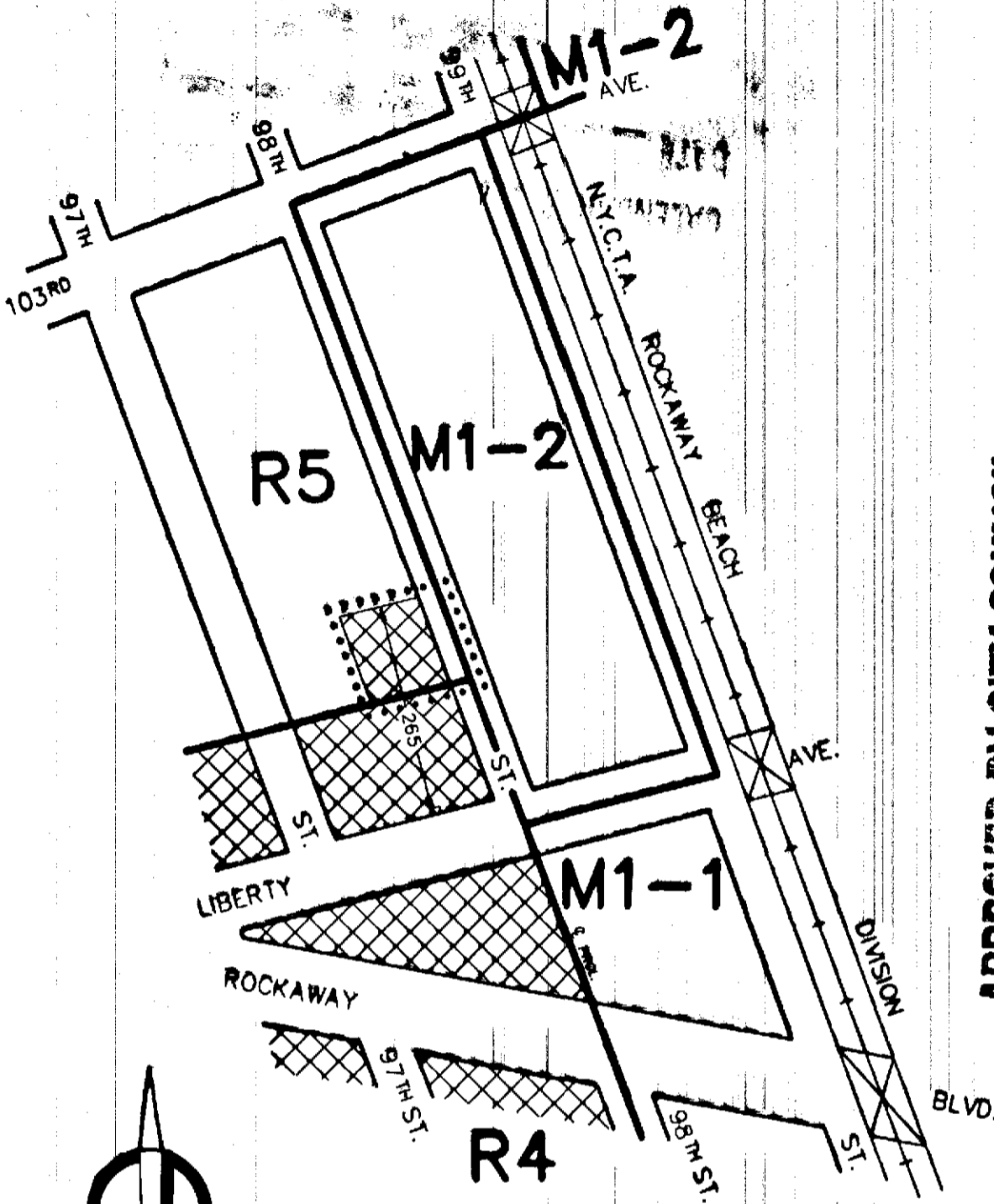

APPROVED BY CITY COUNCIL

CALENDAR # 1669

DATE 12-19-00

A-1803



CITY PLANNING COMMISSION  
CITY OF NEW YORK

DIAGRAM SHOWING PROPOSED  
**ZONING CHANGE**  
 ON SECTIONAL MAP  
**18a**  
 BOROUGH OF  
**QUEENS**

*[Signature]*  
 Director of Technical Review

New York, Certification Date  
JULY 24, 2000

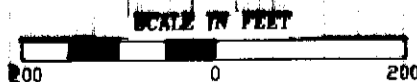

- NOTE:**
- Indicates Zoning District boundary.
  - The area enclosed by the dotted line is proposed to be changed by establishing a C1-2 District within the existing R5 District.
  - Indicates a C1-2 District.

THIS DIAGRAM IS FOR ILLUSTRATIVE PURPOSES ONLY.

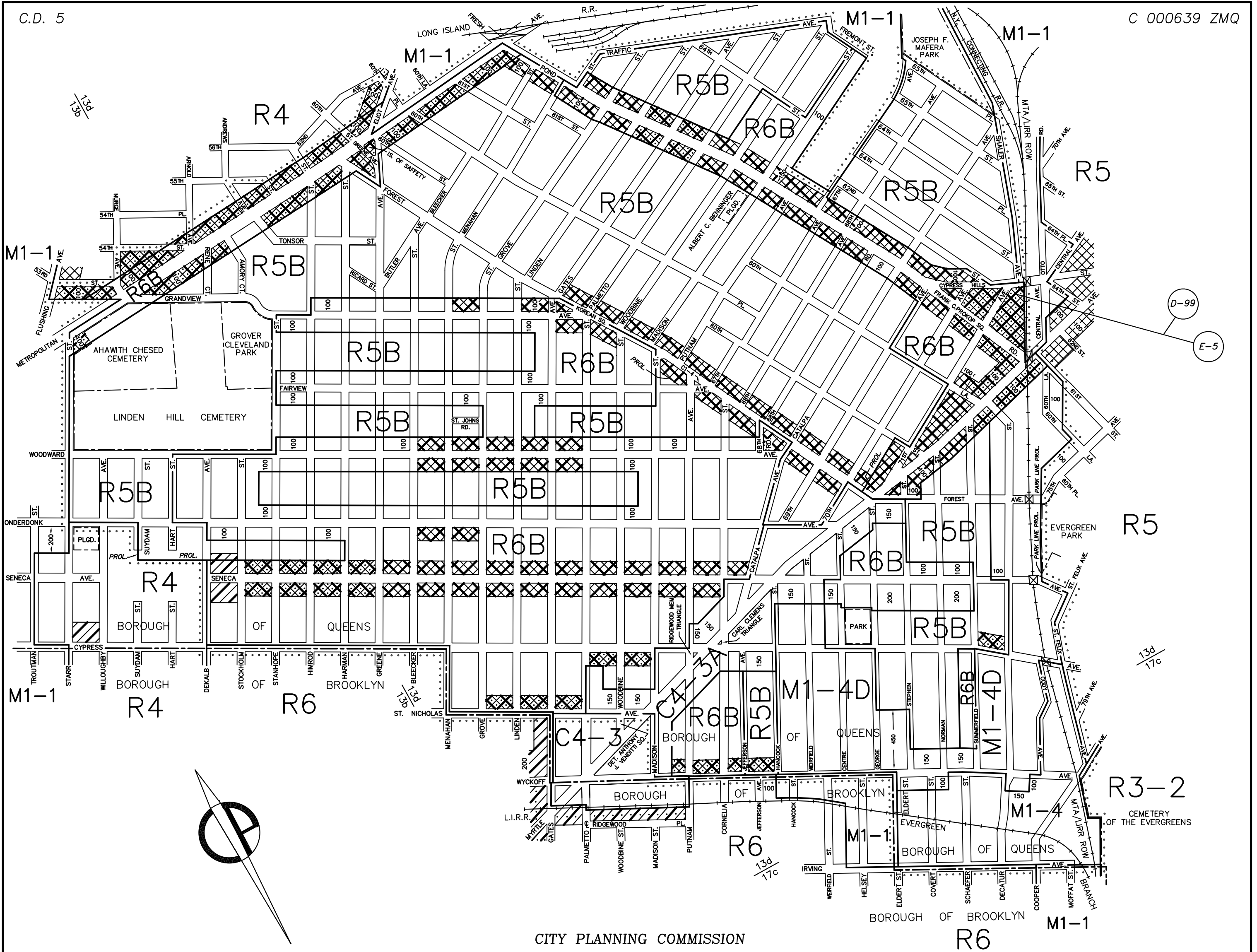





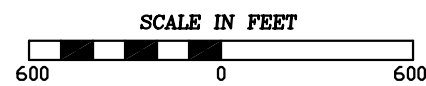

EFFECTIVE DATE:  
**December 19, 2000**  
 C. C. RESO. # 1675

CITY PLANNING COMMISSION  
 CITY OF NEW YORK  
**ZONING CHANGE**  
 ON SECTIONAL MAPS  
**13b, 13d & 17c**  
 BOROUGH OF  
**QUEENS**



**NOTE:**

- Indicates Zoning District boundary.
- ..... The area enclosed by the dotted line is rezoned by eliminating C1-2 and C2-2 Districts from existing R4, R5 and R6 Districts, changing R4, R5, R6, M1-1 and C4-3 Districts to R5B, R6B, C4-3A, M1-1, M1-4 and M1-4D Districts and establishing within the proposed R5B and R6B Districts C1-4 and C2-4 Districts and within an existing R4 District a C2-4 District.
-  Indicates a C1-2 District.
-  Indicates a C1-3 District.
-  Indicates a C1-4 District.
-  Indicates a C2-3 District.
-  Indicates a C2-4 District.
-  Indicates a Restrictive Declaration Area, refer to R.D. sheet.
-  Indicates a City Environmental Quality Review Declaration, refer to C.E.Q.R. sheet.

THIS DIAGRAM IS FOR ILLUSTRATIVE PURPOSES ONLY.

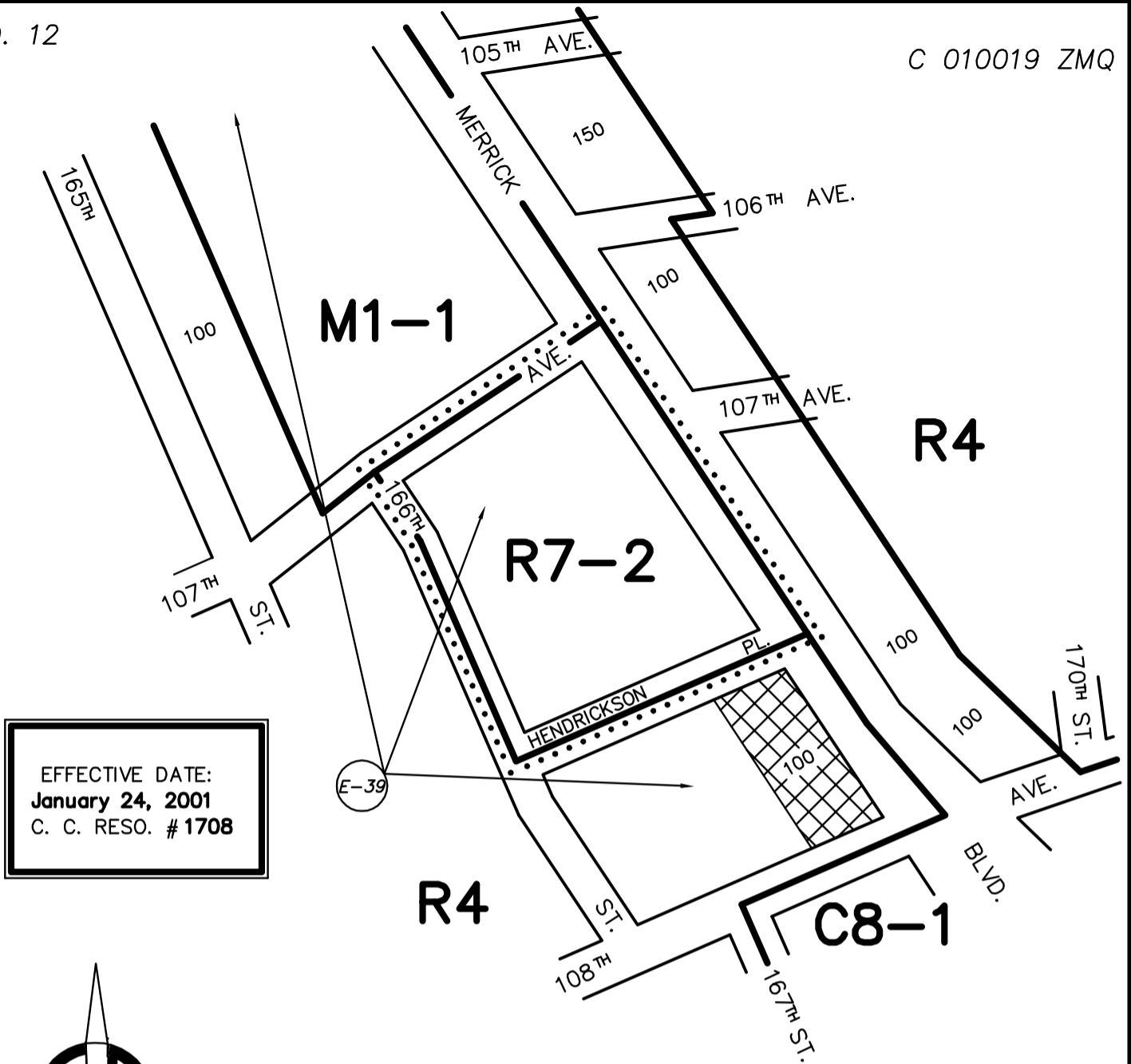

EFFECTIVE DATE:  
**January 24, 2001**  
 C. C. RESO. # 1708

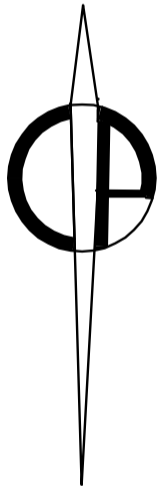

CITY PLANNING COMMISSION  
 CITY OF NEW YORK  
**ZONING CHANGE**  
 ON SECTIONAL MAP  
**14d**  
 BOROUGH OF  
**QUEENS**

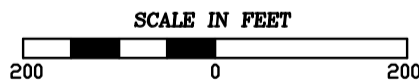

**NOTE:**

- Indicates Zoning District boundary.
- The area enclosed by the dotted line is rezoned by changing M1-1 and R4 Districts to an R7-2 District.
- Indicates a C1-2 District.
- Indicates a City Environmental Quality Review Declaration, refer to C.E.Q.R. sheet.

THIS DIAGRAM IS FOR ILLUSTRATIVE PURPOSES ONLY.

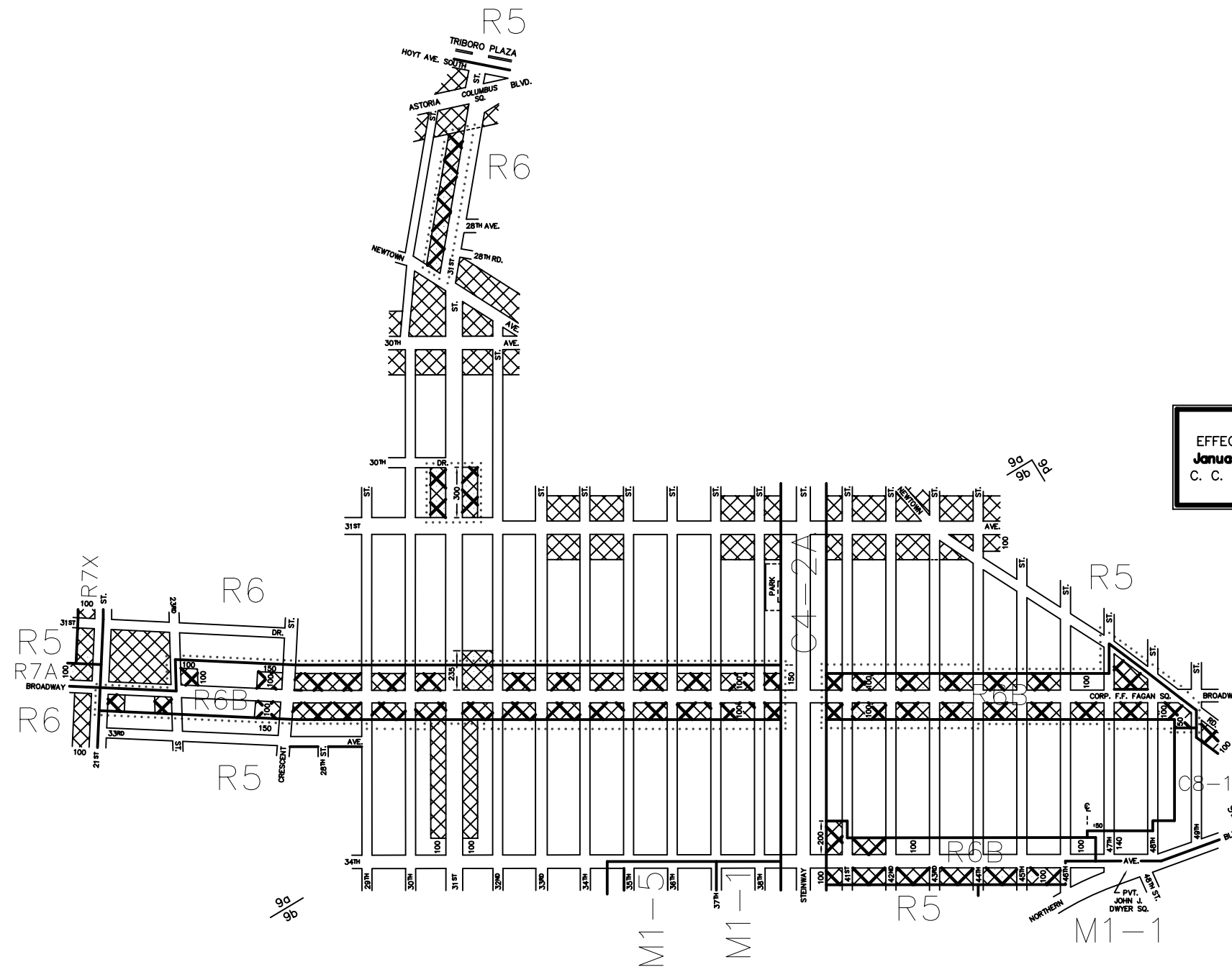



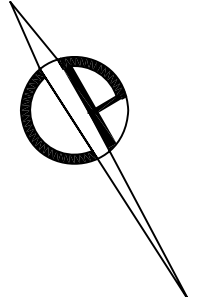

EFFECTIVE DATE:  
**January 24, 2001**  
 C. C. RESO. # 1710

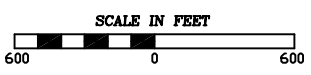

CITY PLANNING COMMISSION  
 CITY OF NEW YORK  
**ZONING CHANGE**  
 ON SECTIONAL MAPS  
**9a, 9b & 9d**  
 BOROUGH OF  
**QUEENS**



**NOTE:** Indicates Zoning District boundary.  
 ..... The areas enclosed by the dotted lines are rezoned by eliminating C1-2, C1-3 and C2-2 Districts from existing R5 and R6 Districts, changing R5 and R6 Districts to R6B District, and by establishing C1-4 and C2-4 Districts within the proposed R6B Districts and the existing R6 District.

-  Indicates a C1-2 District.
-  Indicates a C1-4 District.
-  Indicates a C2-1 District.
-  Indicates a C2-2 District.
-  Indicates a C2-4 District.

THIS DIAGRAM IS FOR ILLUSTRATIVE PURPOSES ONLY.

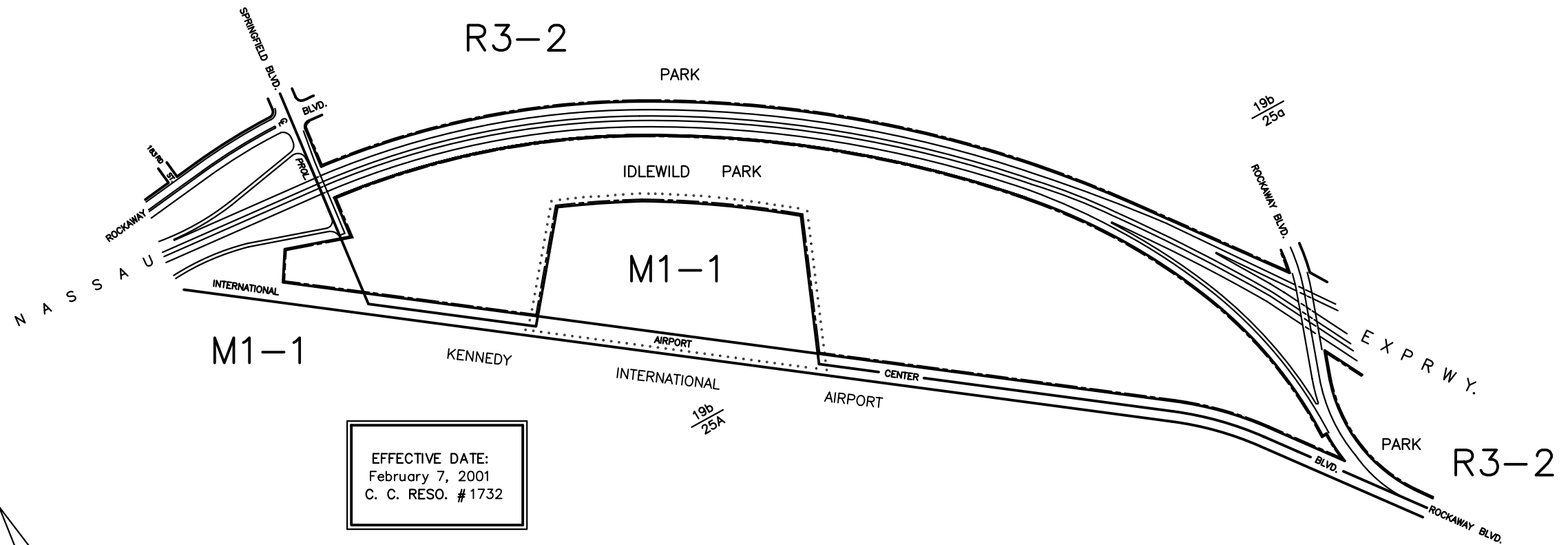

EFFECTIVE DATE:  
February 7, 2001  
C. C. RESO. # 1732

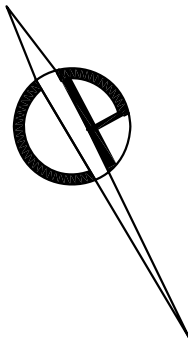

CITY PLANNING COMMISSION  
CITY OF NEW YORK  
**ZONING CHANGE**  
ON SECTIONAL MAPS  
**19b & 25a**  
BOROUGH OF  
**QUEENS**

NOTE: REFER TO APPLICATION C000272 MMQ  
(ALTERATION MAP No. 4954)  
FOR RELATED PARK AND STREET CHANGES  
WITHIN AREA OF THIS ZONING CHANGE.

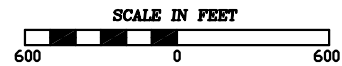

- NOTE:**
- Indicates Zoning District boundary.
  - ..... The area enclosed by the dotted line is rezoned by changing an R3-2 District to an M1-1 District and by establishing an M1-1 District in a former parkland.

THIS DIAGRAM IS FOR ILLUSTRATIVE PURPOSES ONLY.

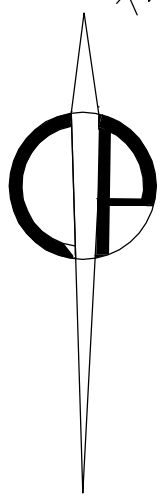
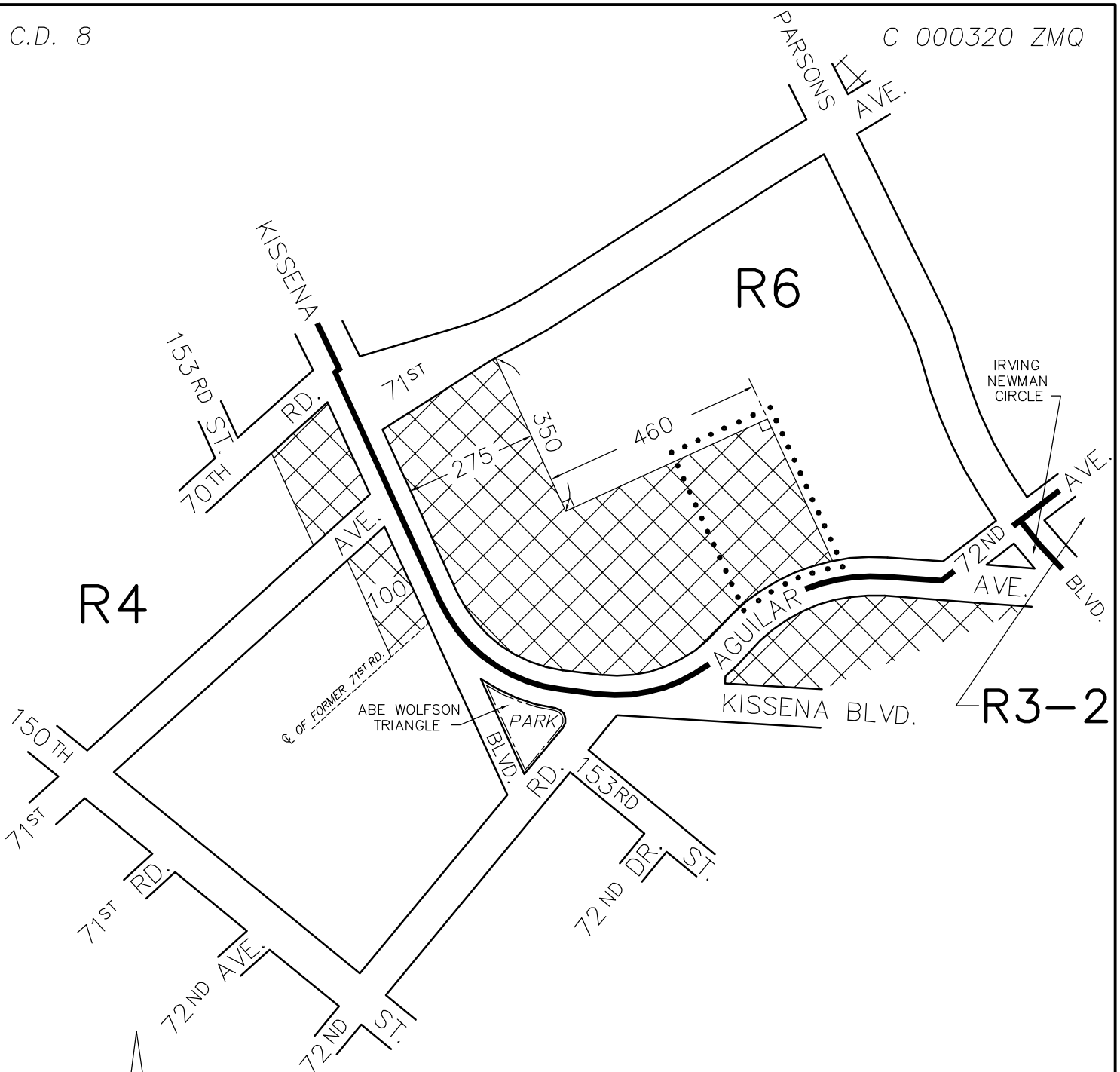

CITY PLANNING COMMISSION  
CITY OF NEW YORK

**ZONING CHANGE**

ON SECTIONAL MAP

**14c**

BOROUGH OF  
**QUEENS**

EFFECTIVE DATE:  
**March 28, 2001**  
C. C. RESO. # 1830

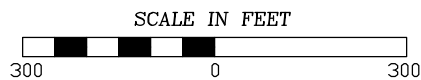

**NOTE:**

- Indicates Zoning District boundary.
- The area enclosed by the dotted line is rezoned by establishing within an existing R6 District a C1-2 District.
- Indicates a C1-2 District.

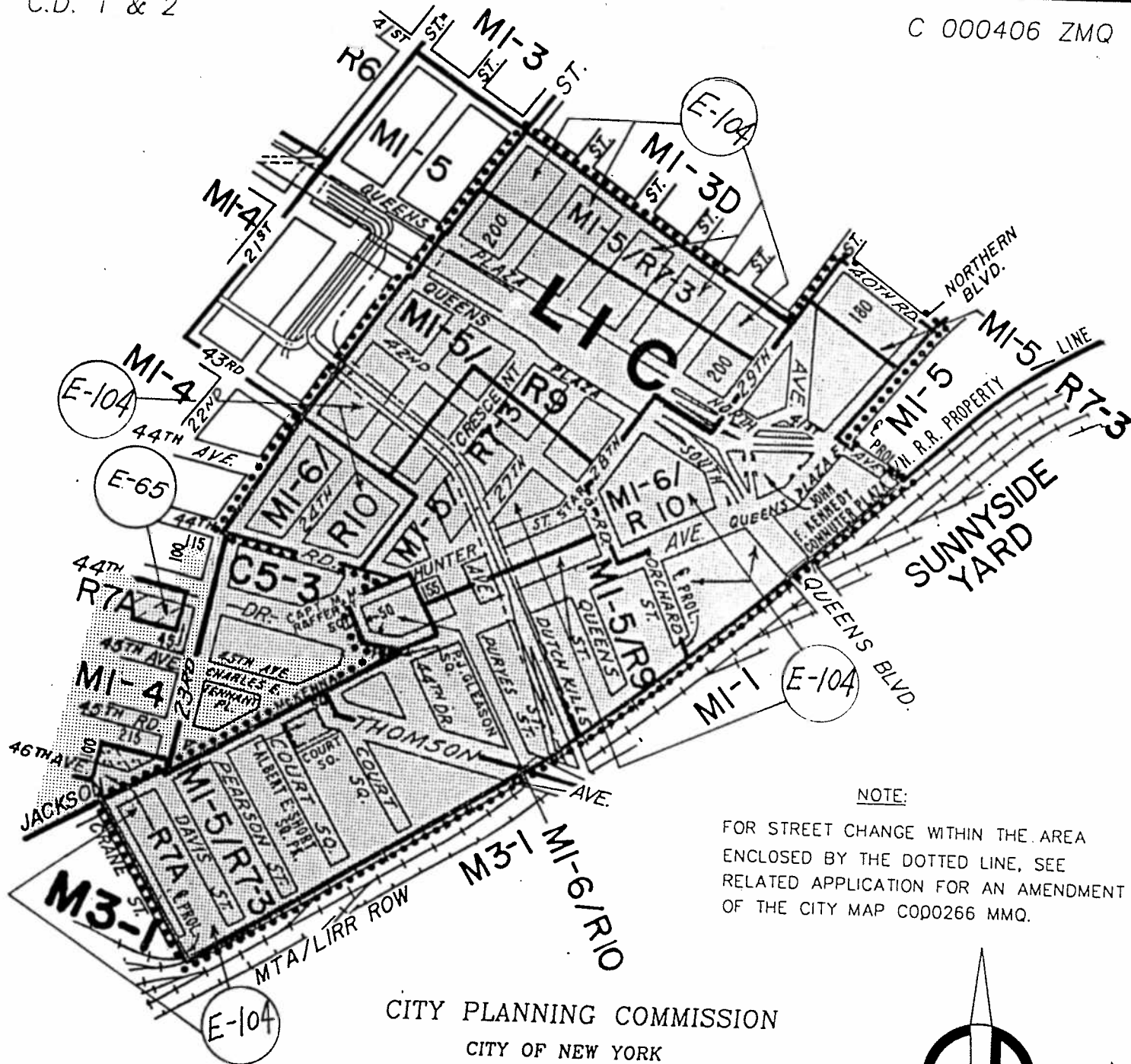

**NOTE:**

FOR STREET CHANGE WITHIN THE AREA ENCLOSED BY THE DOTTED LINE, SEE RELATED APPLICATION FOR AN AMENDMENT OF THE CITY MAP C0D0266 MMQ.

CITY PLANNING COMMISSION  
CITY OF NEW YORK

DIAGRAM SHOWING PROPOSED  
**ZONING CHANGE**  
ON SECTIONAL MAP  
**9b**  
BOROUGH OF  
**QUEENS**

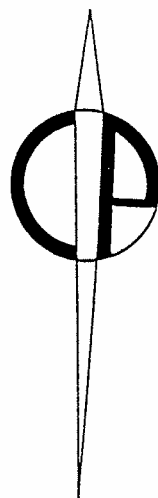



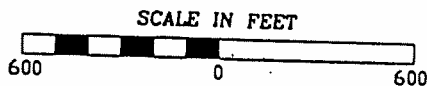

New York, Certification Date  
December, 26, 2000

Director of Technical Review

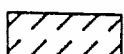
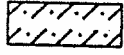

**NOTE:**

-  Indicates Zoning District boundary.
-  The area enclosed by the dotted line is proposed to be rezoned by eliminating a C2-5 District from an existing R7A District, by changing R7A, M1-4, and M1-5 Districts to M1-5/R7-3, M1-5/R9, and M1-6/R10 Districts, and by establishing a Special Long Island City Mixed Use District (LIC).
-  Indicates a C1-5 District.
-  Indicates a C2-5 District.
-  Indicates a Special Long Island City Mixed Use District. [formerly a Special Hunters Point Mixed Use District (HP)].
-  Indicates a City Environmental Quality Review Declaration.

THIS DIAGRAM IS FOR ILLUSTRATIVE PURPOSES ONLY.



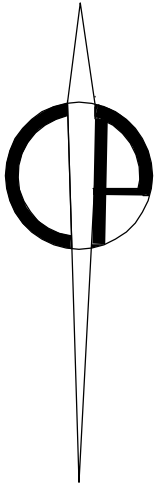
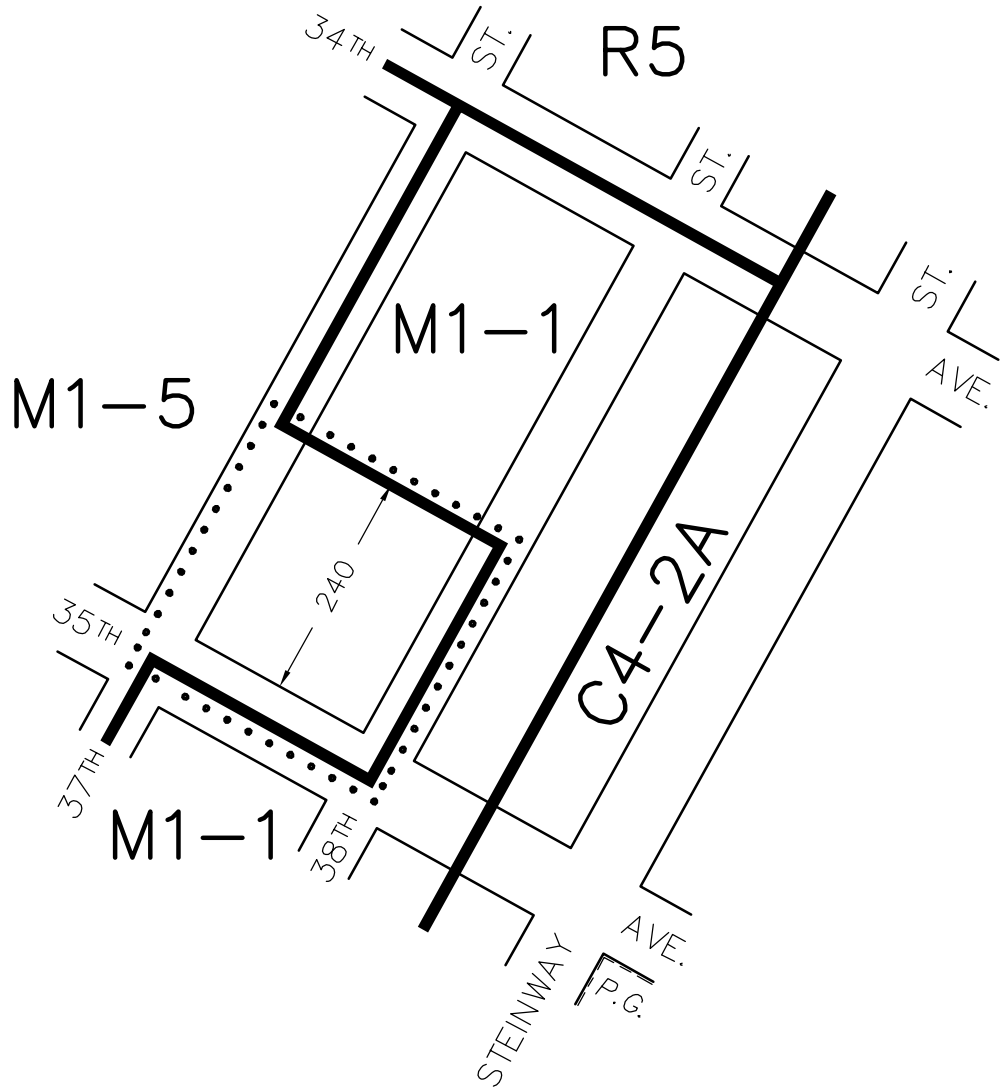

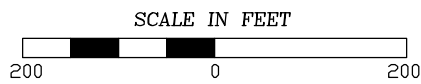

CITY PLANNING COMMISSION  
 CITY OF NEW YORK  
**ZONING CHANGE**  
 ON SECTIONAL MAP  
**9b**  
 BOROUGH OF  
**QUEENS**

EFFECTIVE DATE  
**December 19, 2001**  
 C. C. RESO. # 2176





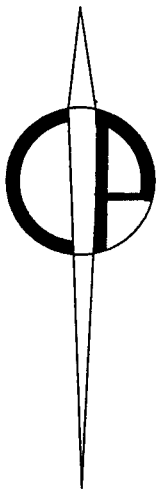
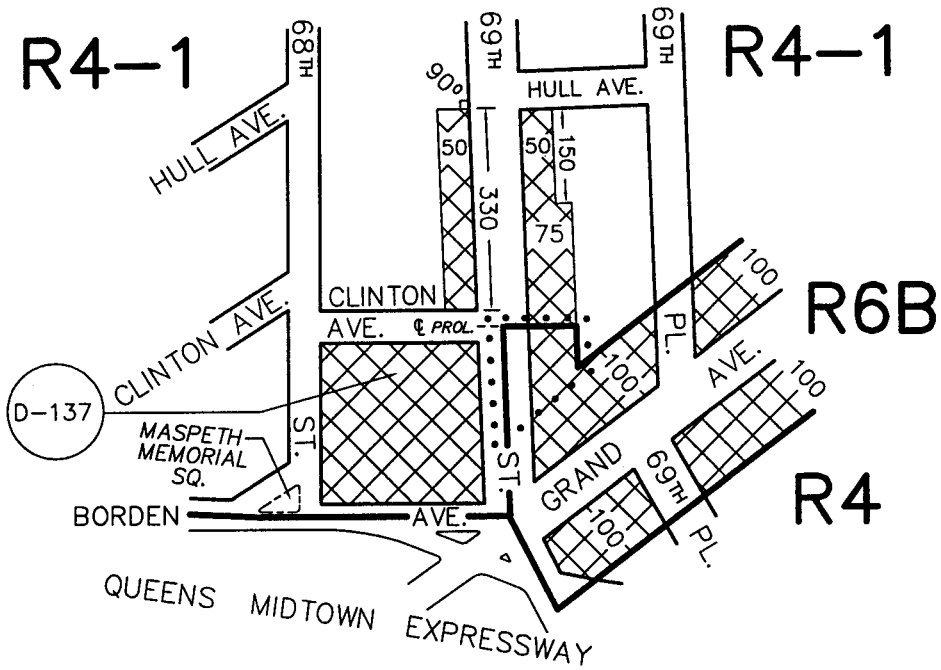

- NOTE:**
-  Indicates Zoning District boundary.
  -  The area enclosed by the dotted line is rezoned by changing an M1-1 District to an M1-5 District.
  -  Indicates a C1-4 District.

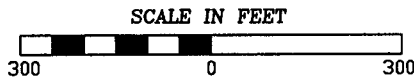

EFFECTIVE DATE  
 January 30, 2002  
 C. C. RESO. # 37

CITY PLANNING COMMISSION  
 CITY OF NEW YORK  
**ZONING CHANGE**  
 ON SECTIONAL MAP  
**13c**  
 BOROUGH OF  
**QUEENS**



- NOTE:**
-  Indicates Zoning District boundary.
  -  The area enclosed by the dotted line is rezoned by changing an R4-1 District to an R6B District.
  -  Indicates a C1-2 District.
  -  Indicates a Restrictive Declaration Area, refer to R.D. sheet.

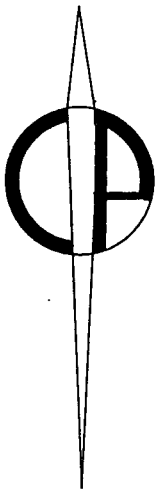
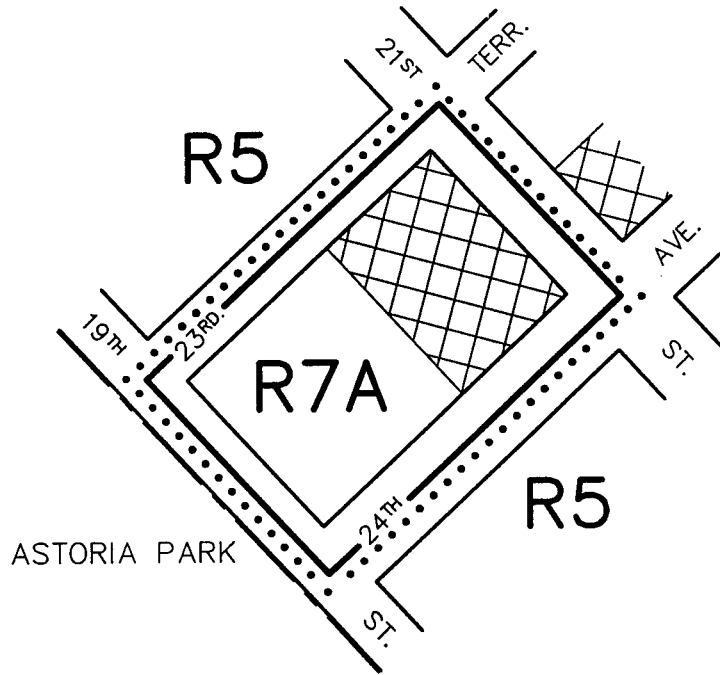

THIS DIAGRAM IS FOR ILLUSTRATIVE PURPOSES ONLY.

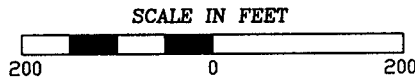

EFFECTIVE DATE  
 January 30, 2002  
 C. C. RESO. # 38

CITY PLANNING COMMISSION  
 CITY OF NEW YORK  
**ZONING CHANGE**  
 ON SECTIONAL MAP  
**9a**  
 BOROUGH OF  
**QUEENS**



- NOTE:**
-  Indicates Zoning District boundary.
  -  The area enclosed by the dotted line is rezoned by changing an R5 District to an R7A District and by establishing a C1-2 District within a proposed R7A District.
  -  Indicates a C1-2 District.

THIS DIAGRAM IS FOR ILLUSTRATIVE PURPOSES ONLY.

R3-2

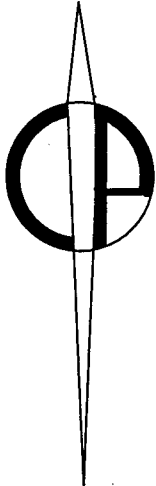
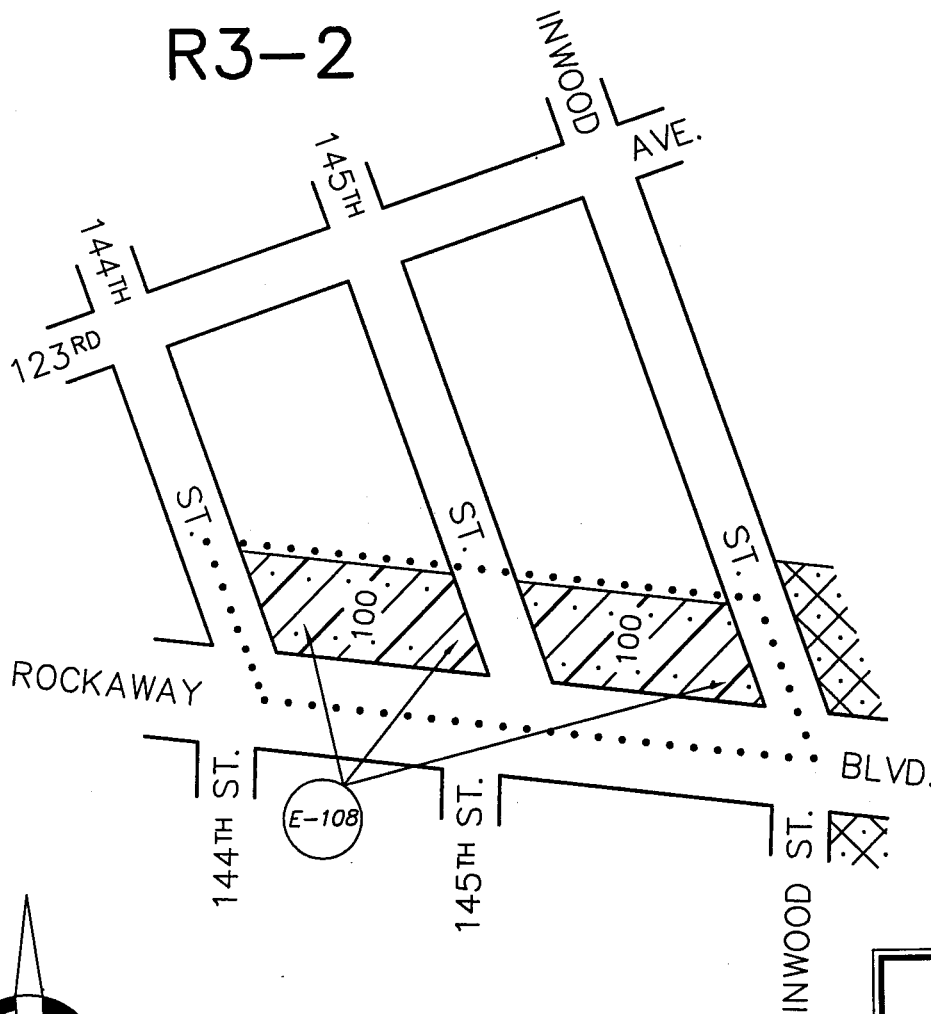

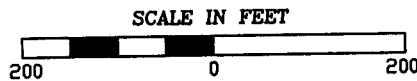

EFFECTIVE DATE  
 February 27, 2002  
 C. C. RESO. # 80

CITY PLANNING COMMISSION  
 CITY OF NEW YORK  
**ZONING CHANGE**  
 ON SECTIONAL MAP  
**18c**  
 BOROUGH OF  
**QUEENS**



NOTE:

- ..... The area enclosed by the dotted line is changed by establishing within an existing R3-2 District a C2-3 District.
-  Indicates a C2-2 District.
-  Indicates a C2-3 District.
-  Indicates a City Environmental Quality Review Declaration, refer to C.E.Q.R. sheet.

THIS DIAGRAM IS FOR ILLUSTRATIVE PURPOSES ONLY.

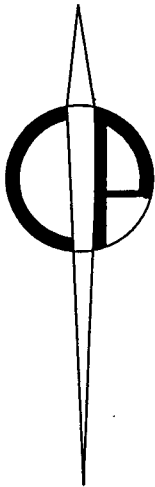
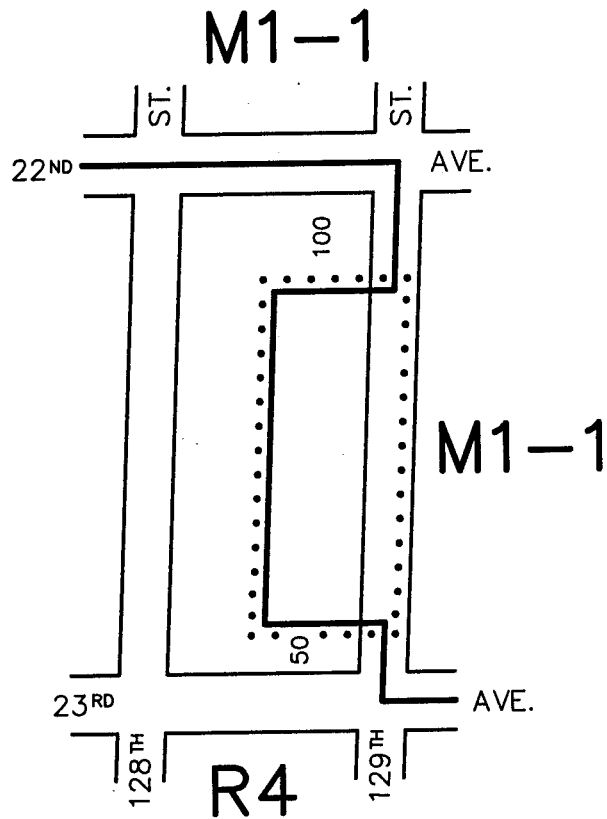

EFFECTIVE DATE  
 March 13, 2002  
 C. C. RESO. # 127

CITY PLANNING COMMISSION  
 CITY OF NEW YORK  
**ZONING CHANGE**  
 ON SECTIONAL MAP  
**10a**  
 BOROUGH OF  
**QUEENS**

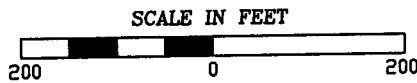

**NOTE:**

- Indicates Zoning District boundary.
- .....** The area enclosed by the dotted line is rezoned by changing an R4 District to an M1-1 District.

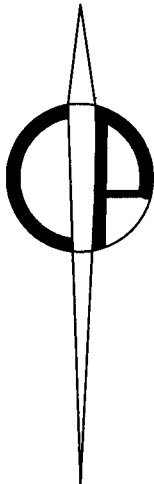
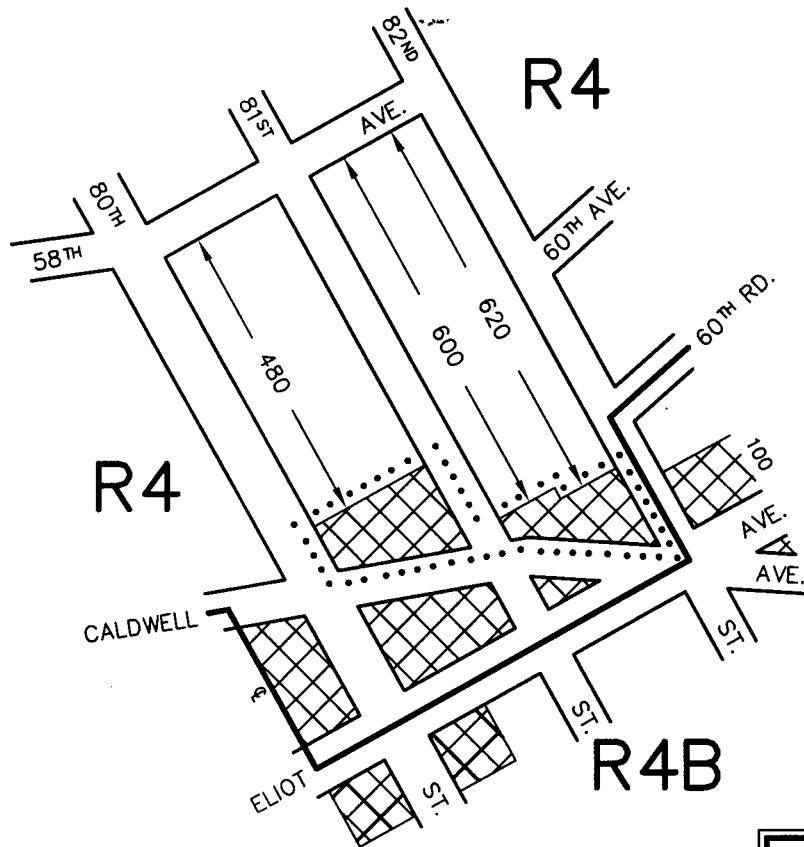

THIS DIAGRAM IS FOR ILLUSTRATIVE PURPOSES ONLY.

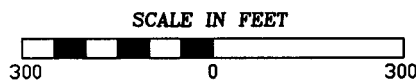

EFFECTIVE DATE  
 April 10, 2002  
 C. C. RESO. # 213

CITY PLANNING COMMISSION  
 CITY OF NEW YORK  
**ZONING CHANGE**  
 ON SECTIONAL MAP  
**13c**  
 BOROUGH OF  
**QUEENS**



- NOTE:**
- Indicates Zoning District boundary.
  - ..... The area enclosed by the dotted line is rezoned by establishing a C1-2 District within an existing R4 District.
  -  Indicates a C1-2 District.
  -  Indicates a C1-4 District.

THIS DIAGRAM IS FOR ILLUSTRATIVE PURPOSES ONLY.

EFFECTIVE DATE
June 5, 2002
C. C. RESO. # 327

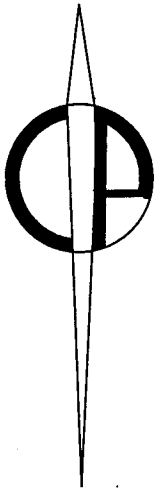
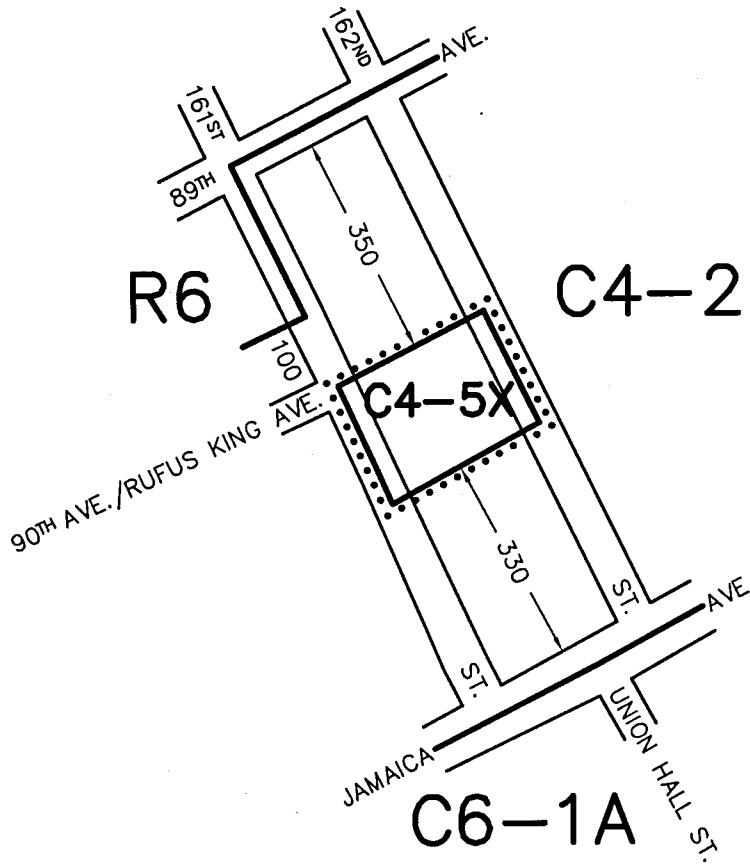

CITY PLANNING COMMISSION  
 CITY OF NEW YORK  
**ZONING CHANGE**  
 ON SECTIONAL MAP  
**14d**  
 BOROUGH OF  
**QUEENS**

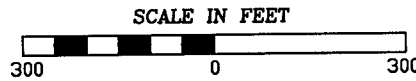

- NOTE:**
- Indicates Zoning District boundary.
  - .....** The area enclosed by the dotted line is rezoned by changing from a C4-2 District to C4-5X District.

THIS DIAGRAM IS FOR ILLUSTRATIVE PURPOSES ONLY.

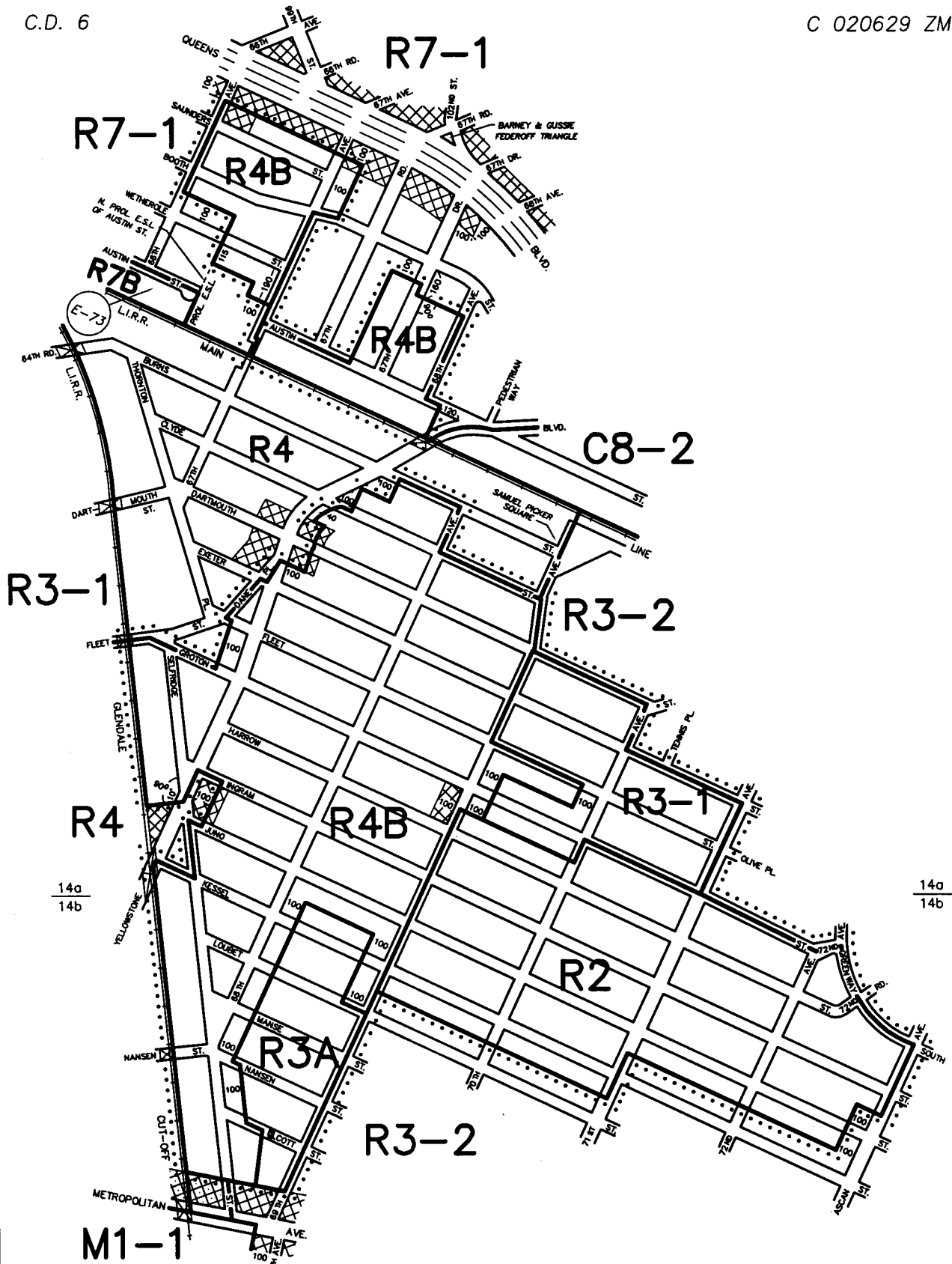

14a  
14b

14a  
14b



NOTE:

————— Indicates Zoning District boundary.

..... The areas enclosed by the dotted lines are rezoned by changing R3-2, R4 and R7-1 Districts to R2, R3-1, R3A and R4B Districts and by establishing a C1-2 District within a proposed R4B District.

 Indicates a C1-2 District.

 Indicates a C2-2 District.



Indicates a City Environmental Quality Declaration, refer to C.E.Q.R. sheet.

THIS DIAGRAM IS FOR ILLUSTRATIVE PURPOSES ONLY.

CITY PLANNING COMMISSION  
 CITY OF NEW YORK  
**ZONING CHANGE**  
 ON SECTIONAL MAPS  
**14a & 14b**  
 BOROUGH OF  
**QUEENS**

EFFECTIVE DATE  
**September 25, 2002**  
 C. C. RESO. # 500

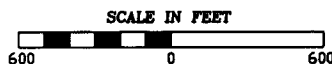



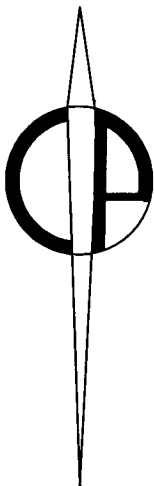
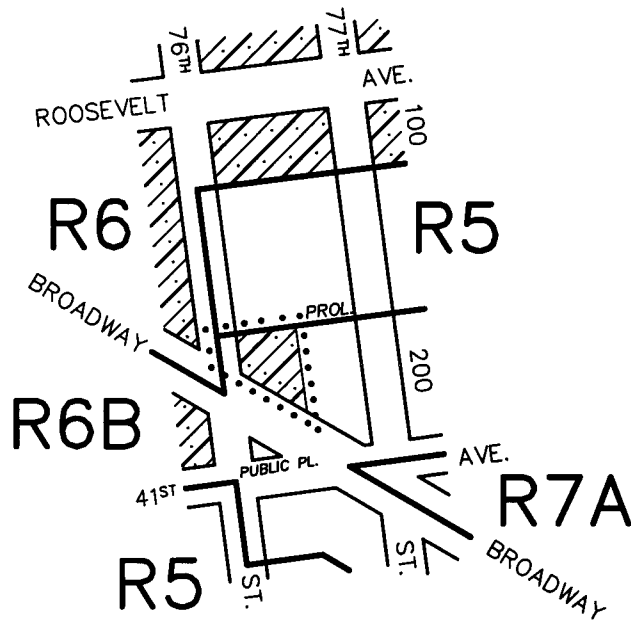

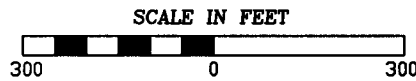

EFFECTIVE DATE  
 October 9, 2002  
 C. C. RESO. # 529

CITY PLANNING COMMISSION  
 CITY OF NEW YORK  
**ZONING CHANGE**  
 ON SECTIONAL MAP  
**9d**  
 BOROUGH OF  
**QUEENS**



- NOTE:**
- Indicates Zoning District boundary.
  - ..... The area enclosed by the dotted line is rezoned by establishing within an existing R6B District a C2-3 District.
  -  Indicates a C2-3 District.

THIS DIAGRAM IS FOR ILLUSTRATIVE PURPOSES ONLY.

ROCKAWAY COMMUNITY PARK

M1-1

EFFECTIVE DATE
January 29, 2003
C. C. RESO. # 683

ROCKAWAY COMMUNITY PARK

ALMEDA AVE.

R4

B. 51ST ST.

U.S. N.Y.C. C3

PIERHEAD AND BULKHEAD

CONCH BASIN

NOTE: REFER TO RELATED APPLICATION FOR FOR AN AMENDMENT TO THE CITY MAP C 020033 MMQ FOR PROPOSED PARK CHANGES WITHIN AREA OF THIS PROPOSED ZONING CHANGE.

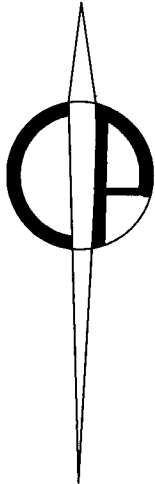

CITY PLANNING COMMISSION  
 CITY OF NEW YORK  
**ZONING CHANGE**  
 ON SECTIONAL MAP  
**30c**  
 BOROUGH OF  
**QUEENS**

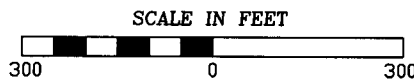

- NOTE:
- Indicates Zoning District boundary.
  - ..... The area enclosed by the dotted line is changed by establishing an M1-1 District within a demapped park.

THIS DIAGRAM IS FOR ILLUSTRATIVE PURPOSES ONLY.

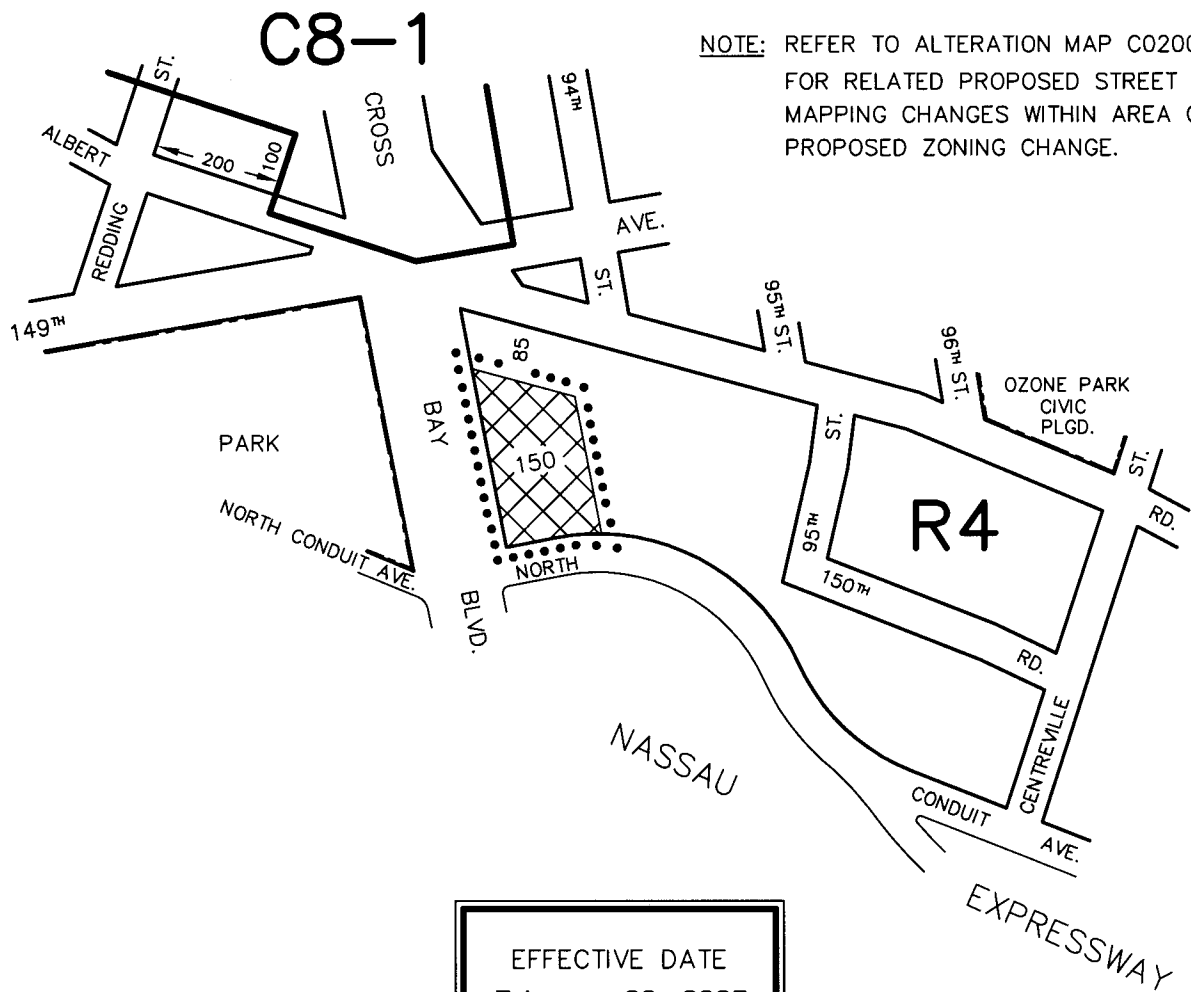

**NOTE:** REFER TO ALTERATION MAP C020070 MMQ FOR RELATED PROPOSED STREET MAPPING CHANGES WITHIN AREA OF THIS PROPOSED ZONING CHANGE.

EFFECTIVE DATE  
**February 26, 2003**  
 C. C. RESO. # 738

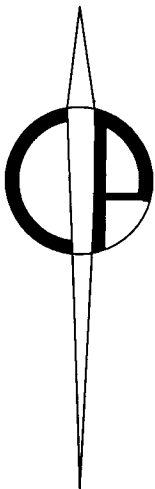

CITY PLANNING COMMISSION  
 CITY OF NEW YORK  
**ZONING CHANGE**  
 ON SECTIONAL MAP  
**18b**  
 BOROUGH OF  
**QUEENS**

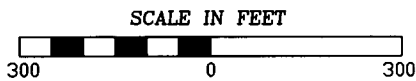

- NOTE:**
- Indicates Zoning District boundary.
  - The area enclosed by the dotted line is rezoned by establishing within an existing R4 District a C1-2 District.
  - Indicates a C1-2 District.

THIS DIAGRAM IS FOR ILLUSTRATIVE PURPOSES ONLY.

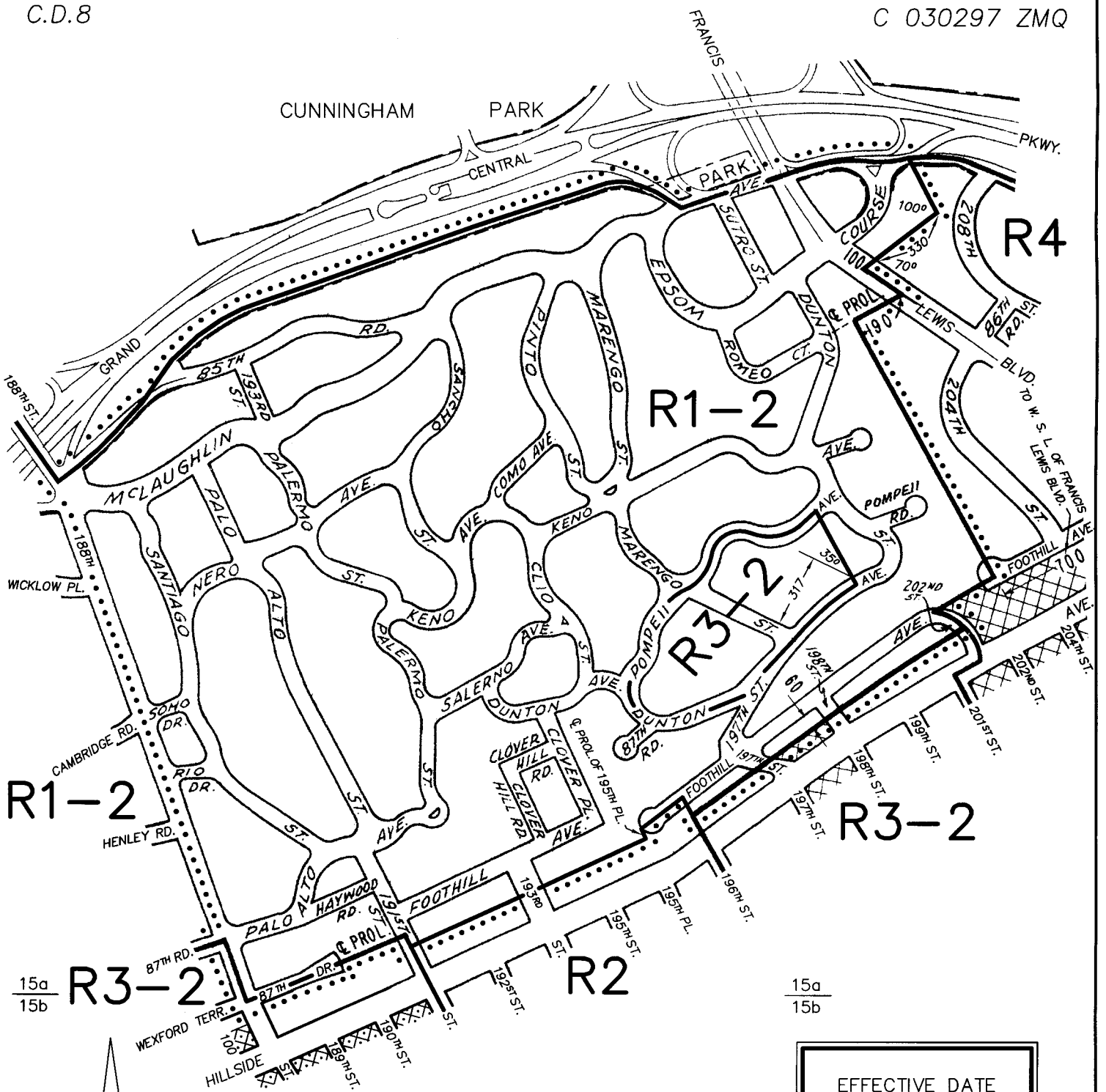

EFFECTIVE DATE  
**June 17, 2003**  
 C. C. RESO. # **953**

CITY PLANNING COMMISSION  
 CITY OF NEW YORK  
**ZONING CHANGE**  
 ON SECTIONAL MAPS  
**15a & 15b**  
 BOROUGH OF  
**QUEENS**

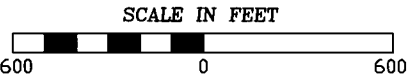

- NOTE:**
- Indicates Zoning District boundary.
  - The area enclosed by the dotted line is rezoned by changing an R2 District to R1-2 and R3-2 Districts.
  - Indicates a C1-2 District.
  - Indicates a C2-2 District.

THIS DIAGRAM IS FOR ILLUSTRATIVE PURPOSES ONLY.

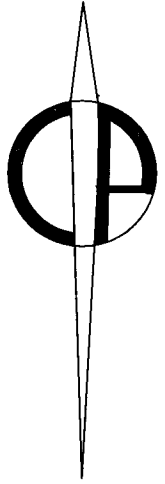
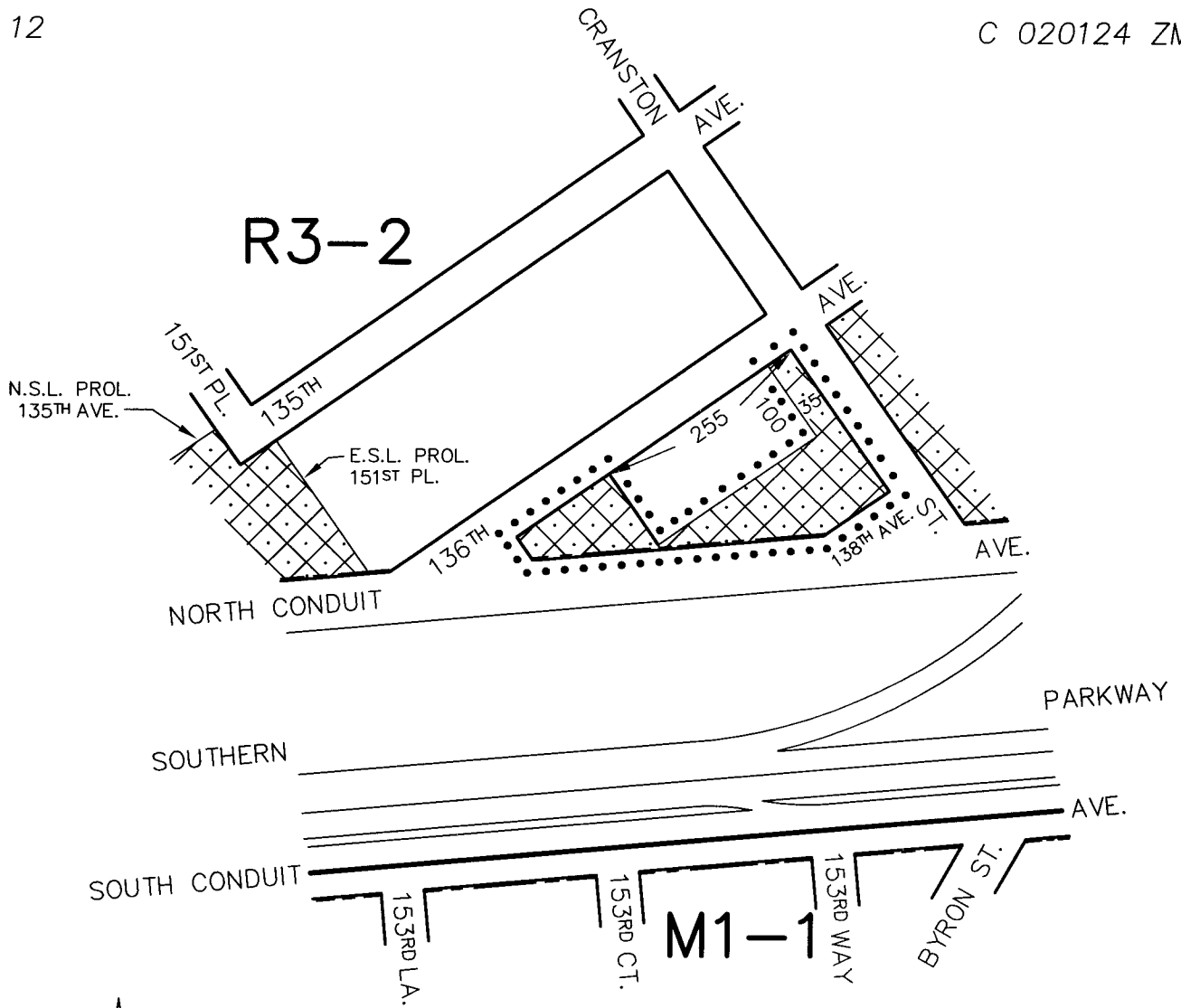

EFFECTIVE DATE  
July 30, 2003

CITY PLANNING COMMISSION  
CITY OF NEW YORK  
**ZONING CHANGE**  
ON SECTIONAL MAP  
**18d**  
BOROUGH OF  
**QUEENS**

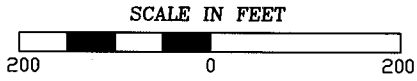

- NOTE:**
- Indicates Zoning District boundary.
  - The area enclosed by the dotted line is rezoned by establishing within an existing R3-2 District a C2-2 District.
  - ⊗ Indicates a C2-2 District.

THIS DIAGRAM IS FOR ILLUSTRATIVE PURPOSES ONLY.

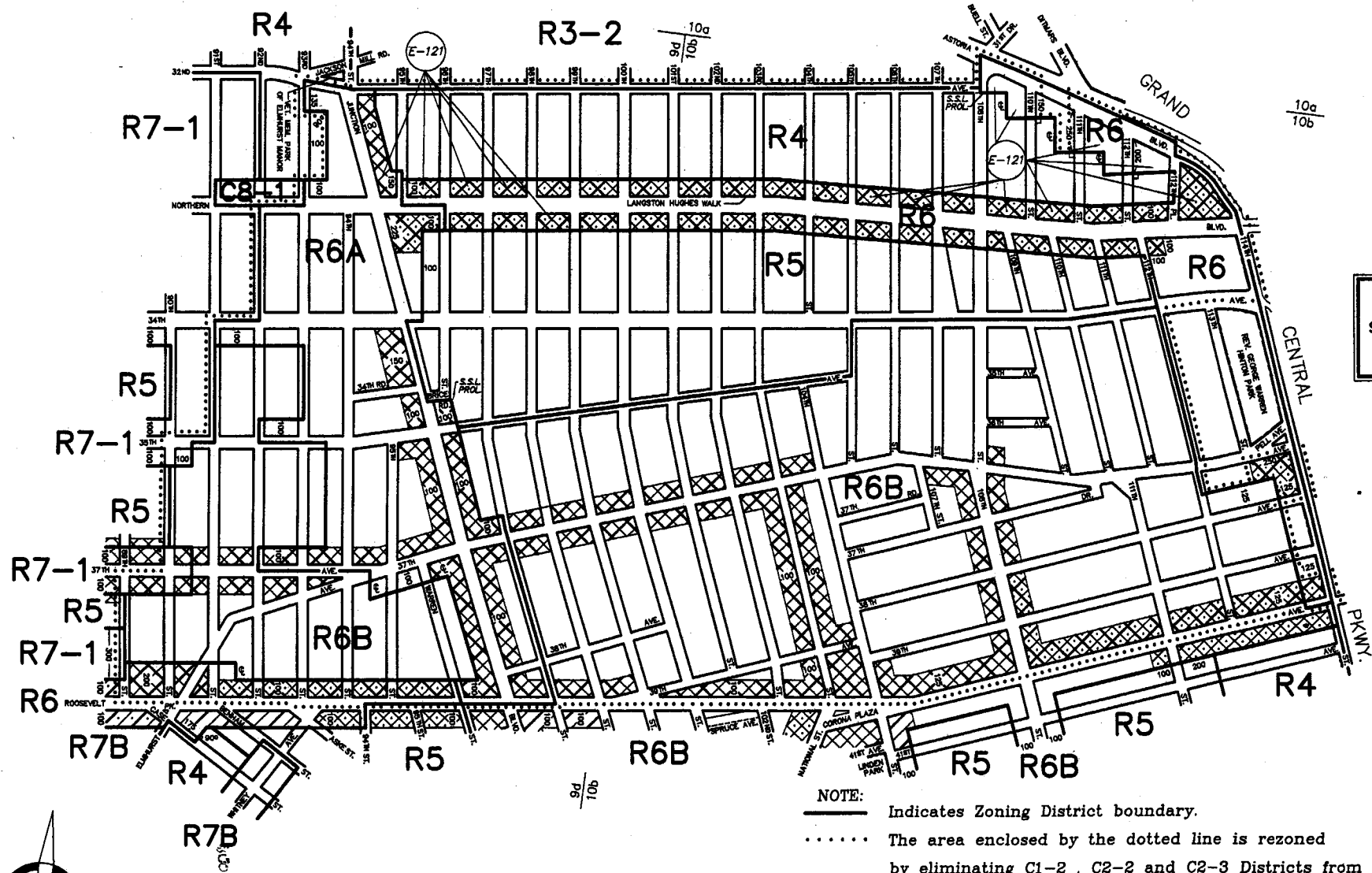







EFFECTIVE DATE:  
**September 17, 2003**  
 C. C. RESO. # 1044



CITY PLANNING COMMISSION  
 CITY OF NEW YORK  
**ZONING CHANGE**  
 ON SECTIONAL MAPS  
**9d, 10a & 10b**  
 BOROUGH OF  
**QUEENS**



**NOTE:**

- ..... Indicates Zoning District boundary.
- ..... The area enclosed by the dotted line is rezoned by eliminating C1-2, C2-2 and C2-3 Districts from existing R5 and R6 Districts, changing R5, R6 and C8-1 Districts to R4, R6, R6A, R6B and R7-1 Districts, and by establishing C1-4 and C2-4 Districts within the proposed R6, R6A and R6B Districts, and the existing R6 District.
-  Indicates a C1-2 District.
-  Indicates a C1-3 District.
-  Indicates a C1-4 District.
-  Indicates a C2-2 District.
-  Indicates a C2-3 District.
-  Indicates a C2-4 District.
-  Indicates a City Environmental Quality Review Declaration, refer to C.E.Q.R. sheet.

THIS DIAGRAM IS FOR ILLUSTRATIVE PURPOSES ONLY.

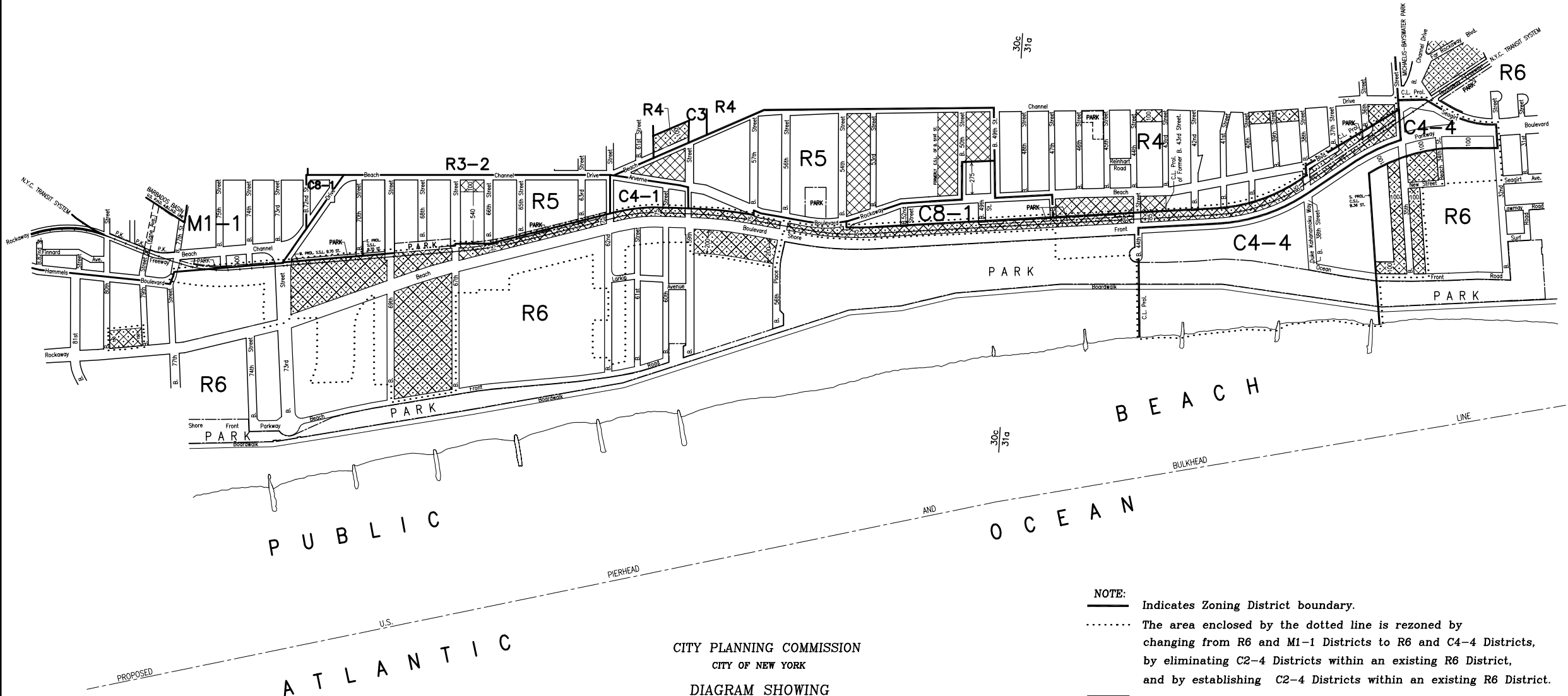

**NOTE:** Indicates Zoning District boundary.  
 ..... The area enclosed by the dotted line is rezoned by changing from R6 and M1-1 Districts to R6 and C4-4 Districts, by eliminating C2-4 Districts within an existing R6 District, and by establishing C2-4 Districts within an existing R6 District.

▨ Indicates a C1-2 District.  
 ▨ Indicates a C2-2 District.  
 ▨ Indicates a C2-4 District.

**NOTE:** THIS DIAGRAM IS FOR ILLUSTRATIVE PURPOSES ONLY.  
 THIS DIAGRAM REFLECTS PROPOSED CHANGES IN THE CITY MAP PURSUANT TO RELATED MAPPING APPLICATION C 030433 MMQ.

CITY PLANNING COMMISSION  
 CITY OF NEW YORK  
 DIAGRAM SHOWING  
 ZONING CHANGE  
 ON SECTIONAL MAPS  
 30c & 31a  
 BOROUGH OF  
 QUEENS

EFFECTIVE DATE  
 November 19, 2003  
 C. C. RESO. # 1171

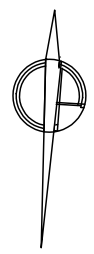

SCALE IN FEET  
 400 0 400

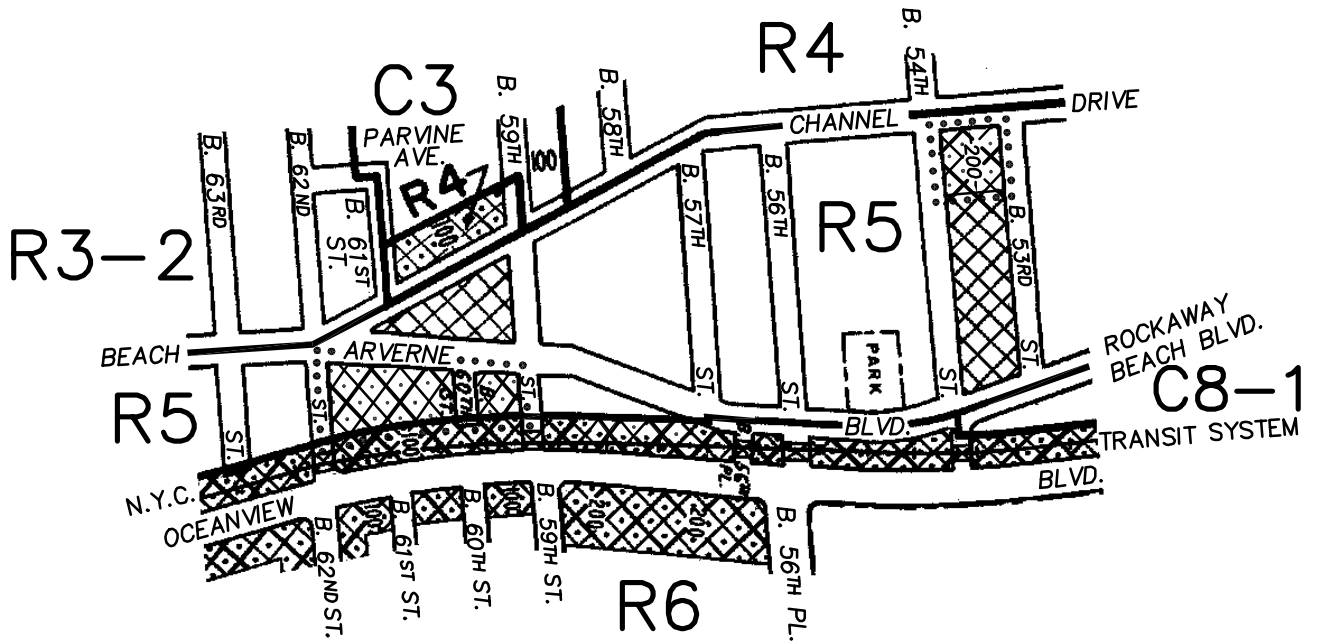

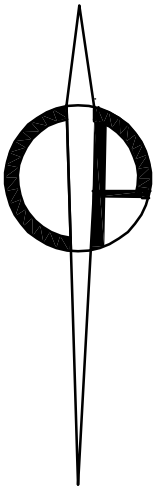

EFFECTIVE DATE  
 February 4, 2004  
 C. C. RESO. # 96

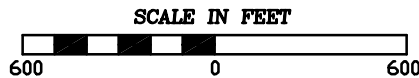

CITY PLANNING COMMISSION  
 CITY OF NEW YORK  
**ZONING CHANGE**  
 ON SECTIONAL MAP  
**30c**  
 BOROUGH OF  
**QUEENS**



**NOTE:**

- Indicates Zoning District boundary.
- ..... The areas enclosed by the dotted lines are rezoned by eliminating a C1-2 District within an existing R5 District, changing from a C4-1 District to an R5 District, and by establishing a C2-4 District within the existing and proposed R5 District.
-  Indicates a C1-2 District.
-  Indicates a C2-4 District.

THIS DIAGRAM IS FOR ILLUSTRATIVE PURPOSES ONLY.



11d  
15c

11d  
15c

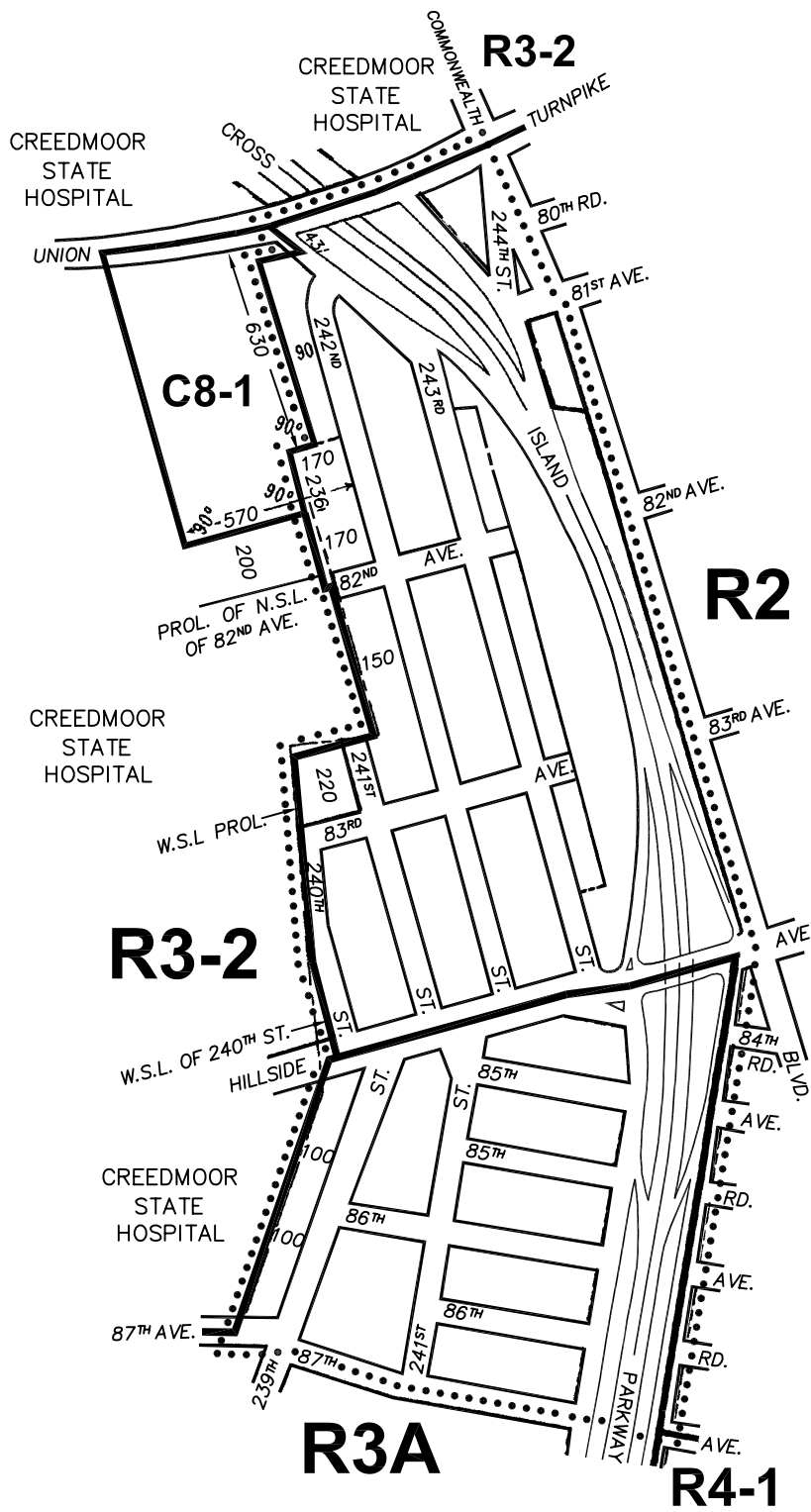

EFFECTIVE DATE  
**July 21, 2004**  
 C. C. RESO. # 494

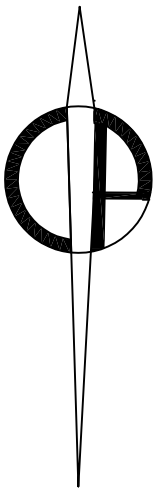

CITY PLANNING COMMISSION  
 CITY OF NEW YORK  
**ZONING CHANGE**  
 ON SECTIONAL MAPS  
**11d & 15c**  
 BOROUGH OF  
**QUEENS**

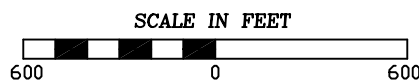

**NOTE:**

- Indicates Zoning District boundary.
- .....** The area enclosed by the dotted line is rezoned by changing an R3-2 District to R2 & R3A Districts.

THIS DIAGRAM IS FOR ILLUSTRATIVE PURPOSES ONLY.

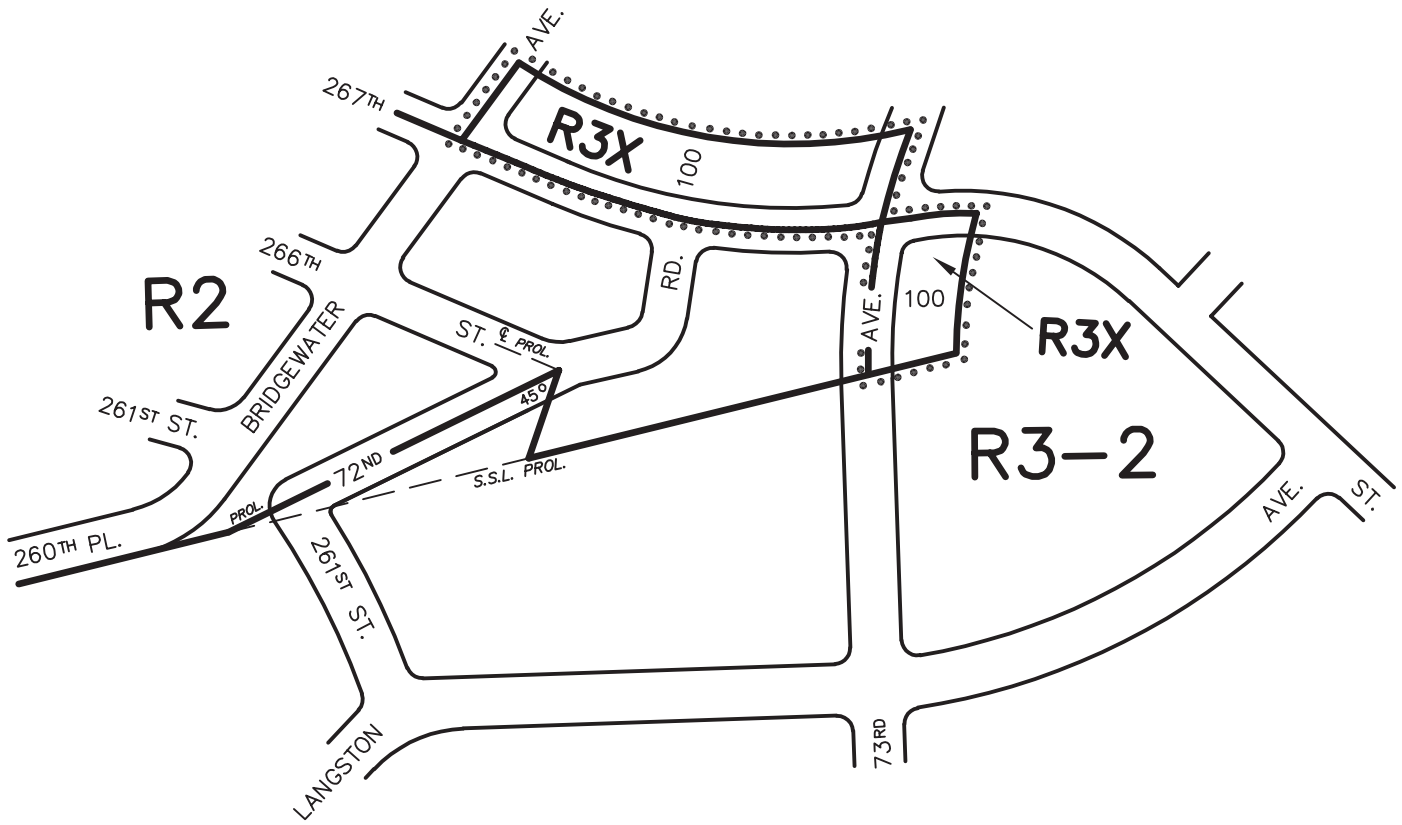

EFFECTIVE DATE  
**July 21, 2004**  
 C. C. RESO. # 507

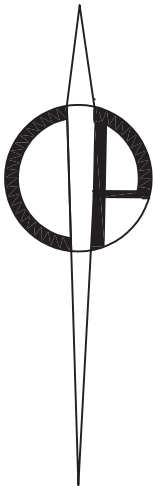

CITY PLANNING COMMISSION  
 CITY OF NEW YORK  
**ZONING CHANGE**  
 ON SECTIONAL MAP  
**11d**  
 BOROUGH OF  
**QUEENS**

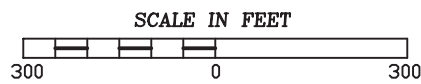

**NOTE:**

- Indicates Zoning District boundary.
- .....** The area enclosed by the dotted line is rezoned by changing an R3-2 District to an R3X District.

THIS DIAGRAM IS FOR ILLUSTRATIVE PURPOSES ONLY.

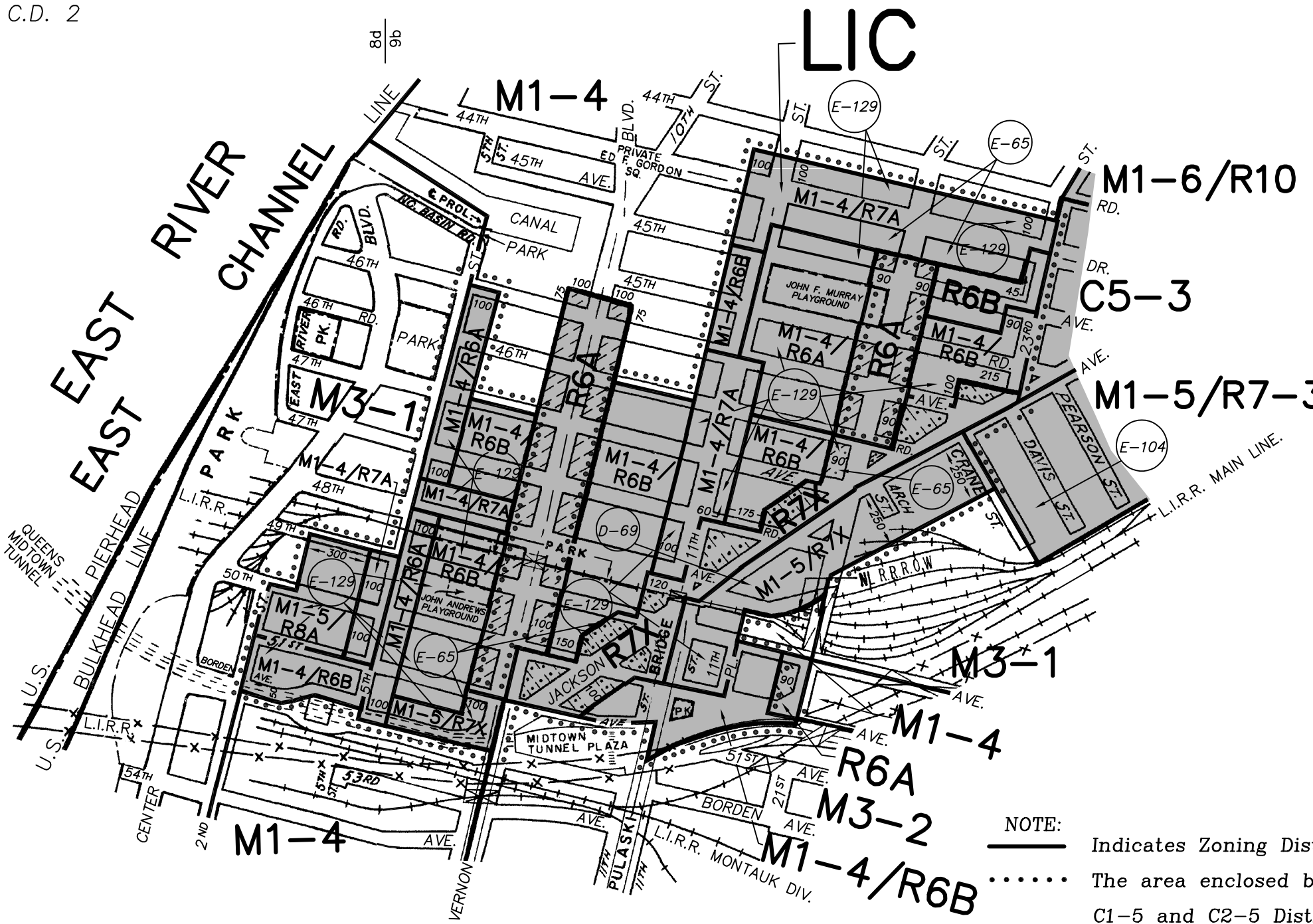

CITY PLANNING COMMISSION  
 CITY OF NEW YORK  
**ZONING CHANGE**  
 ON SECTIONAL MAPS  
**8d & 9b**  
 BOROUGH OF  
**QUEENS**

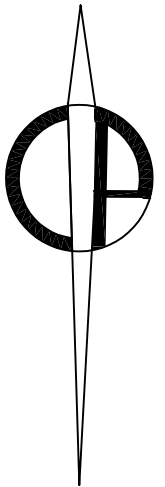
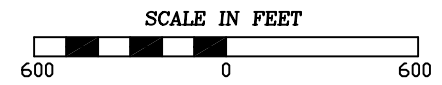

EFFECTIVE DATE  
**August 12, 2004**  
 C. C. RESO. # 527

- NOTE:**
- Indicates Zoning District boundary.
  - ..... The area enclosed by the dotted line is rezoned by eliminating C1-5 and C2-5 Districts, and by changing R6A, R7A, M1-4, M1-6 and M3-1 Districts to R6B, R7X, M1-4/R6A, M1-4/R6B, M1-4/R7A, M1-5/R7X and M1-5/R8A Districts, and by establishing a C2-5 District and a Special Long Island City Mixed Use District.
  - Indicates a C1-5 District.
  - Indicates a C2-5 District.
  - Indicates a Special Long Island City Mixed Use District.
  - Indicates a City Environmental Quality Review Declaration, refer to C.E.Q.R. sheet.
  - Indicates a Restrictive Declaration Area, refer to R.D. sheet.

THIS DIAGRAM IS FOR ILLUSTRATIVE PURPOSES ONLY.

# R3-2

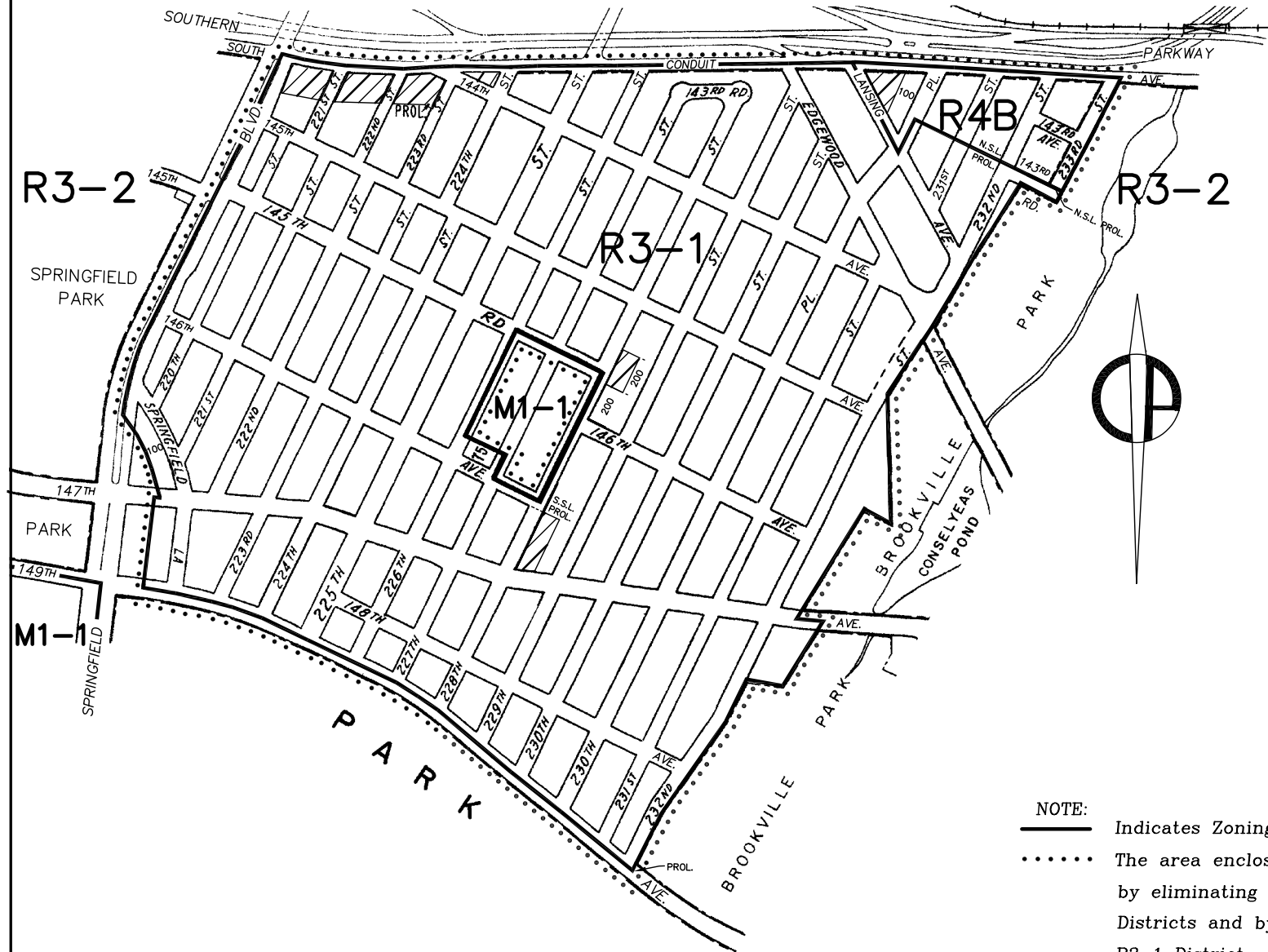

EFFECTIVE DATE  
**September 28, 2004**  
 C. C. RESO. # 603

CITY PLANNING COMMISSION  
 CITY OF NEW YORK  
**ZONING CHANGE**  
 ON SECTIONAL MAP  
**19b**  
 BOROUGH OF  
**QUEENS**

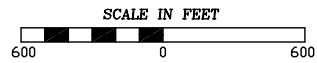

- NOTE:**
- \_\_\_\_\_ Indicates Zoning District boundary.
  - ..... The area enclosed by the dotted line is rezoned by eliminating a C2-2 District and changing an R3-2 to R3-1 and R4B Districts and by establishing C1-3 Districts within the proposed R3-1 District and R4B Districts.
  - ▨ Indicates a C1-3 District.

THIS DIAGRAM IS FOR ILLUSTRATIVE PURPOSES ONLY.

14c  
14d

14c  
14d

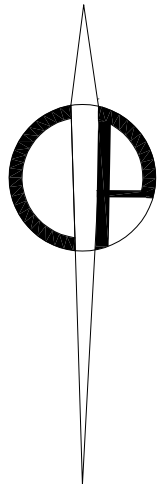
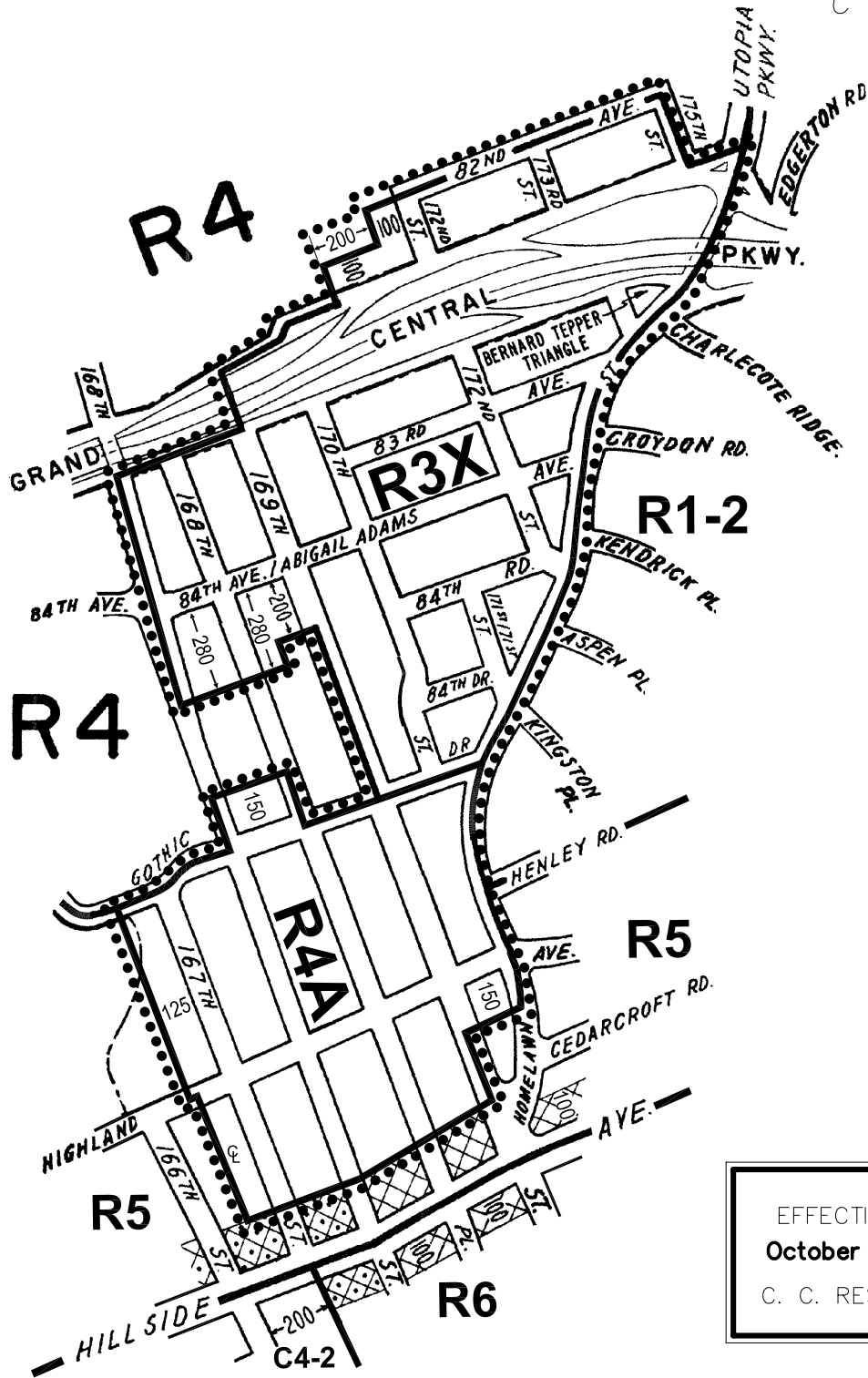

EFFECTIVE DATE  
**October 13, 2004**  
 C. C. RESO. # **630**

CITY PLANNING COMMISSION  
 CITY OF NEW YORK

**ZONING CHANGE**  
 ON SECTIONAL MAPS  
**14c & 14d**  
 BOROUGH OF  
**QUEENS**

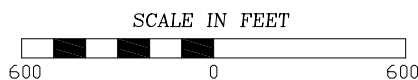

- NOTE:**
- Indicates Zoning District boundary.
  - The area enclosed by the dotted line are rezoned by changing R3-2, R4 and R5 Districts to R3X and R4A Districts.
  - Indicates a C1-2 District.
  - Indicates a C2-2 District.

THIS DIAGRAM IS FOR ILLUSTRATIVE PURPOSES ONLY.

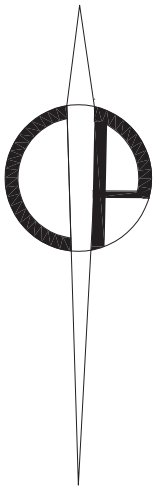
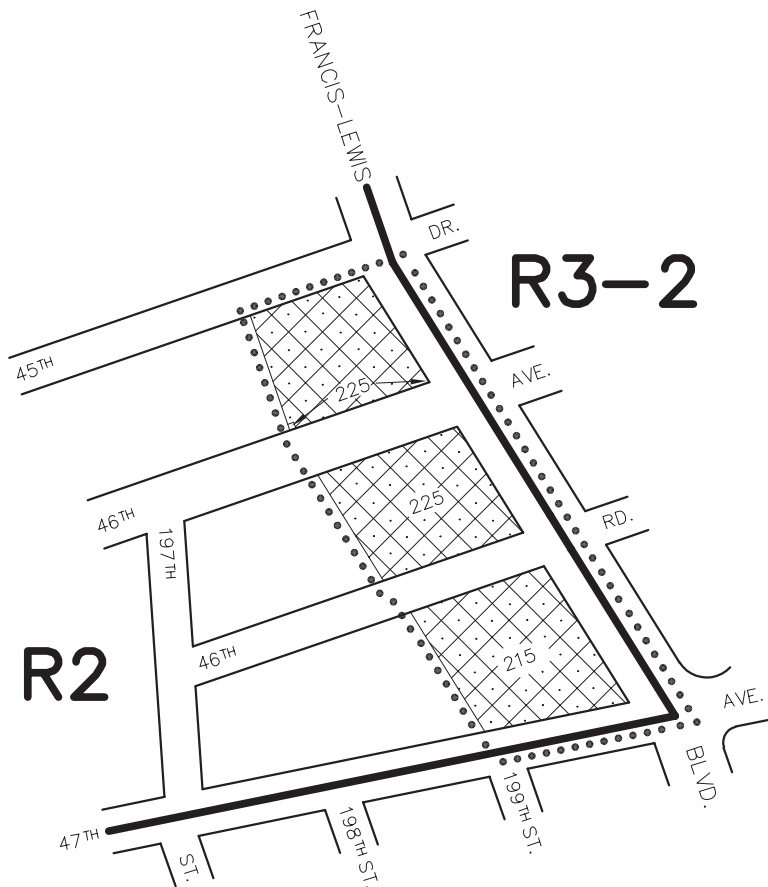

EFFECTIVE DATE  
December 15, 2004  
C. C. RESO. # 736

CITY PLANNING COMMISSION  
CITY OF NEW YORK  
**ZONING CHANGE**  
ON SECTIONAL MAP  
**10d**  
BOROUGH OF  
**QUEENS**

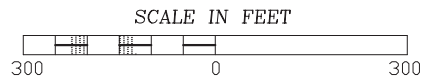

- NOTE:**
- Indicates Zoning District boundary.
  - The area enclosed by the dotted line is rezoned by establishing a C2-2 District within an existing R2 District.
  - Indicates a C2-2 District.

THIS DIAGRAM IS FOR ILLUSTRATIVE PURPOSES ONLY.

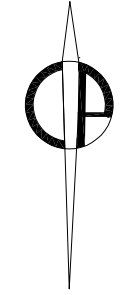
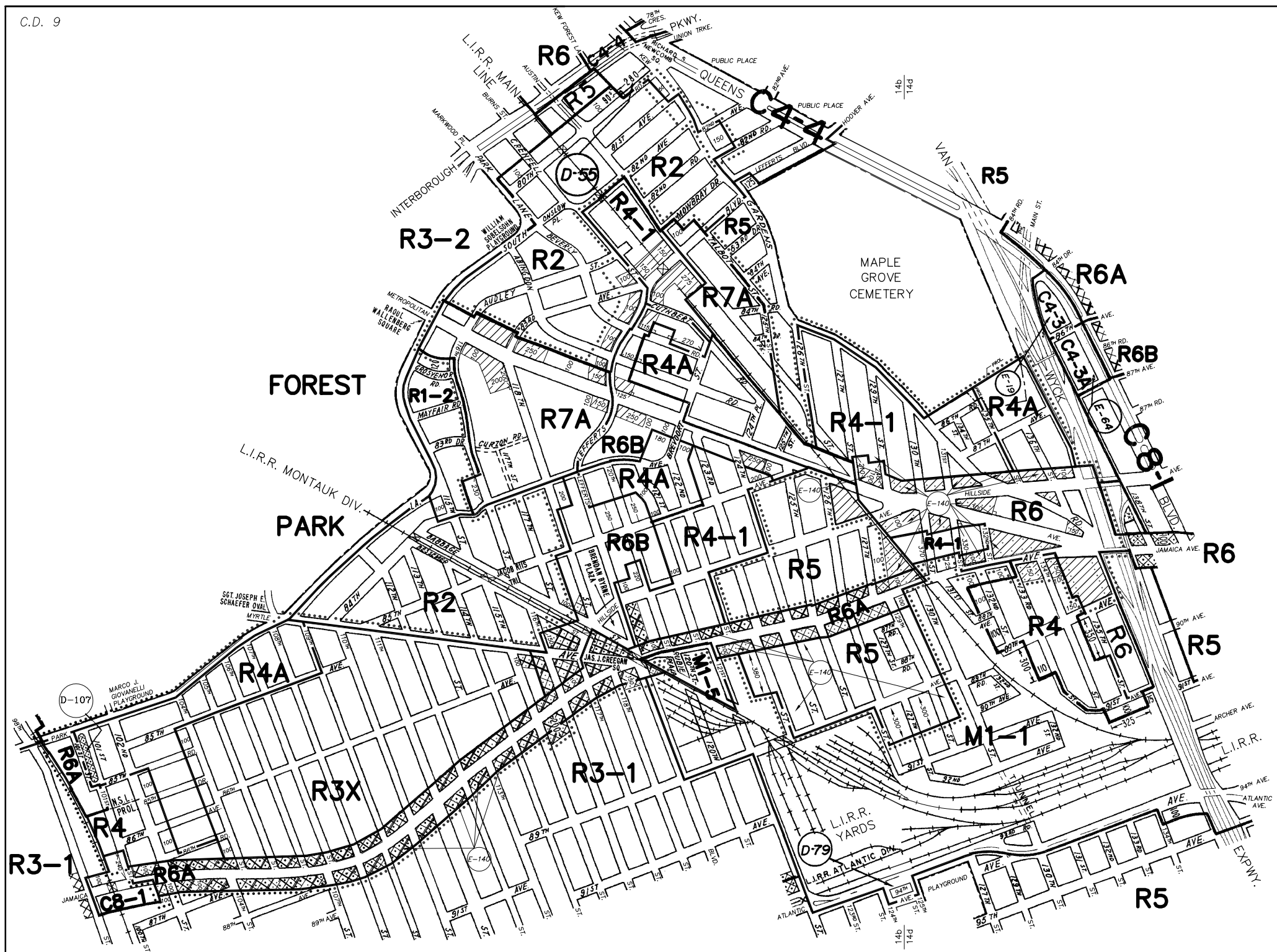

CITY PLANNING COMMISSION  
 CITY OF NEW YORK  
 DIAGRAM SHOWING PROPOSED  
**ZONING CHANGE**  
 ON SECTIONAL MAPS  
**14b & 14d**  
 BOROUGH OF  
**QUEENS**

EFFECTIVE DATE  
 March 9, 2005  
 C. C. RESO. # 880

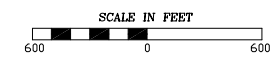

- NOTE:**
- Indicates Zoning District boundary.
  - ..... The areas enclosed by the dotted lines are proposed to be rezoned by eliminating C1-2 and C2-2 Districts from existing R3-1, R4, R5 and R7-1 Districts, by changing R2, R3-1, R4, R5, R7-1, C8-1 and M1-1 Districts to R2, R3-1, R3X, R4, R4A, R4-1, R5, R6, R6A, R6B, R7A, C4-4 and C8-1 Districts, and by establishing within existing and proposed R3-1, R3X, R4, R4-1, R4A, R5, R6, R6A, R6B and R7A Districts C1-3, C2-3 and C2-4 Districts.
  - Indicates a C1-2 District.
  - Indicates a C1-3 District.
  - Indicates a C2-3 District.
  - Indicates a C2-4 District.
  - Indicates a City Environmental Quality Review Declaration, refer to C.E.Q.R. sheet.
  - Indicates a Restrictive Declaration Area, refer to R.D. sheet.

THIS DIAGRAM IS FOR ILLUSTRATIVE PURPOSES ONLY.

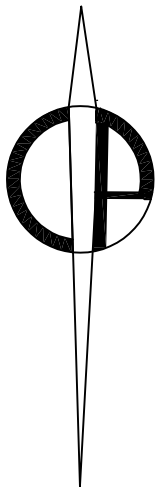
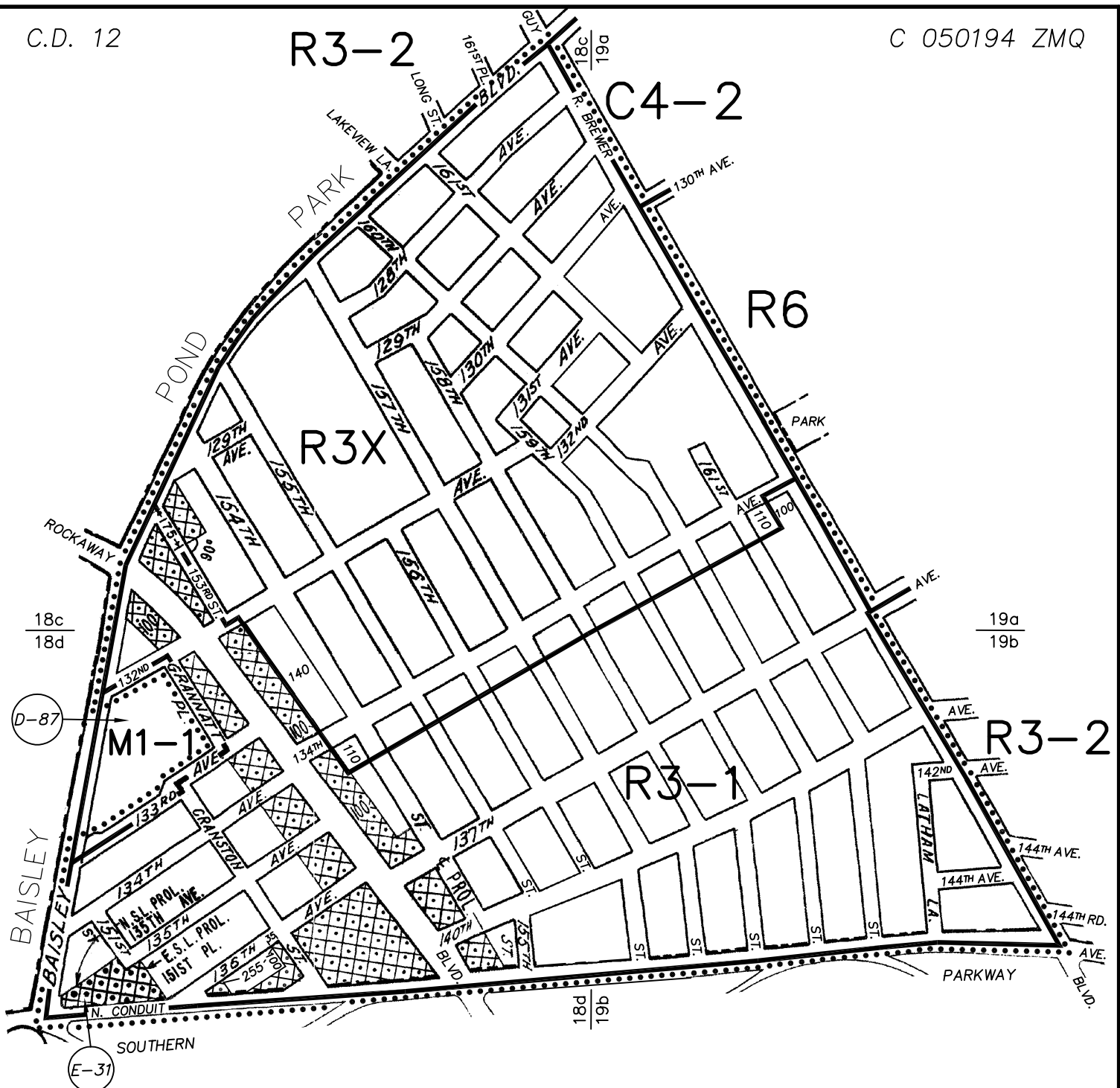

CITY PLANNING COMMISSION  
 CITY OF NEW YORK  
**ZONING CHANGE**  
 ON SECTIONAL MAPS  
**18c, 18d, 19a & 19b**  
 BOROUGH OF  
**QUEENS**

EFFECTIVE DATE  
 April 12, 2005  
 C. C. RESO. # 930

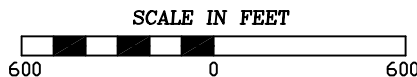

NOTE:

- Indicates Zoning District boundary.
- ..... The area enclosed by the dotted line is proposed to be rezoned by changing an R3-2 District to R3-1 and R3X Districts.
- ▣ Indicates a C2-2 District.
- (E) Indicates a City Environmental Quality Review Declaration, refer to C.E.Q.R. sheet.
- (D) Indicates a Restrictive Declaration Area, refer to R.D. sheet.

THIS DIAGRAM IS FOR ILLUSTRATIVE PURPOSES ONLY.



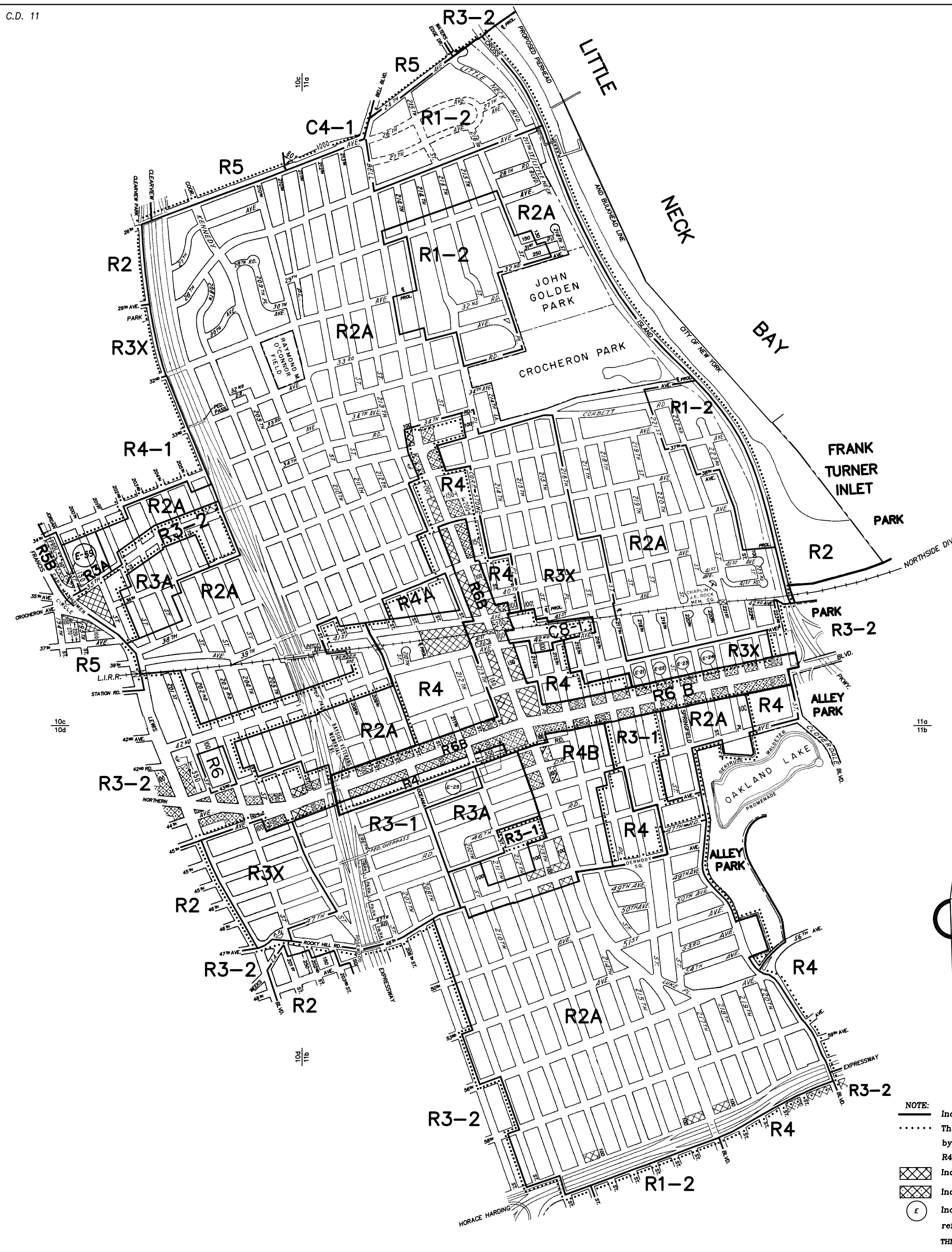

CITY PLANNING COMMISSION  
 CITY OF NEW YORK  
**ZONING CHANGE**  
 ON SECTIONAL MAPS  
 10c, 10d, 11a & 11b  
 BOROUGH OF  
 QUEENS

EFFECTIVE DATE  
 April 12, 2005  
 C. C. RESO. # 934

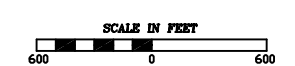

- NOTE:**
- Indicates Zoning District boundary.
  - ..... The areas enclosed by the dotted lines are proposed to be rezoned by changing R2, R3-1, R3-2, R4 and R4A Districts to R1-2, R2A, R3A, R3X, R3-1, R4B and R4-1 Districts, and by eliminating C1-2 District.
  - ⊗ Indicates a C1-2 District.
  - ⊗ Indicates a C2-2 District.
  - ⊙ Indicates a City Environmental Quality Review Declaration, refer to C.E.Q.R. sheet.
- THIS DIAGRAM IS FOR ILLUSTRATIVE PURPOSES ONLY.

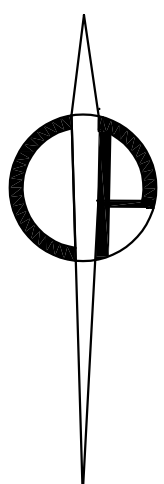
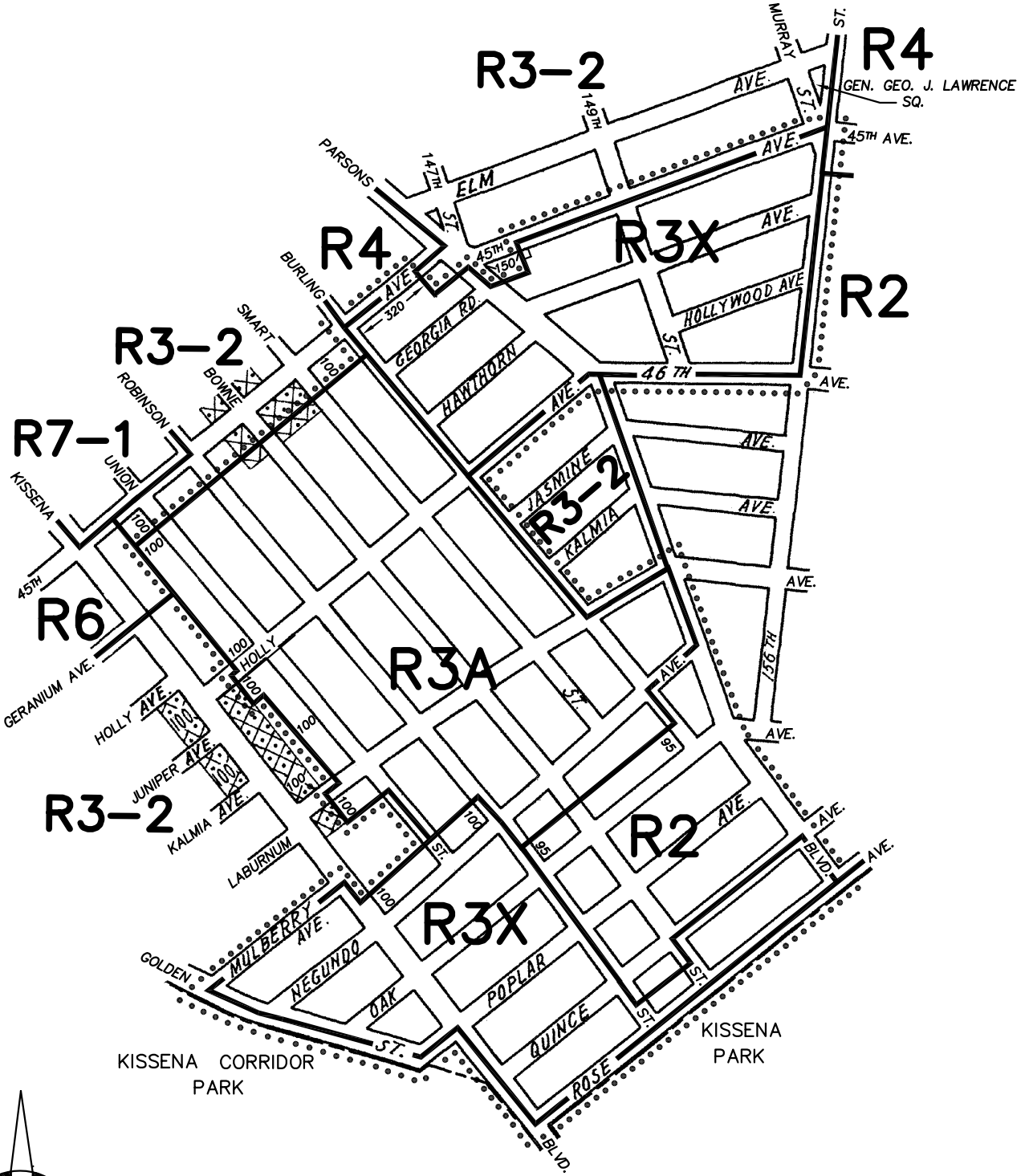

CITY PLANNING COMMISSION  
 CITY OF NEW YORK  
**ZONING CHANGE**  
 ON SECTIONAL MAP  
**10d**  
 BOROUGH OF  
**QUEENS**

EFFECTIVE DATE  
**May 11, 2005**  
 C. C. RESO. # **959**

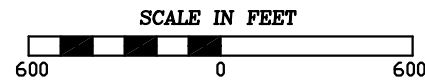

- NOTE:**
- Indicates Zoning District boundary.
  - The area enclosed by the dotted line is to be changed from an R3-2 District to R2, R3A and R3X Districts.
  - Indicates a C2-2 District.

THIS DIAGRAM IS FOR ILLUSTRATIVE PURPOSES ONLY.

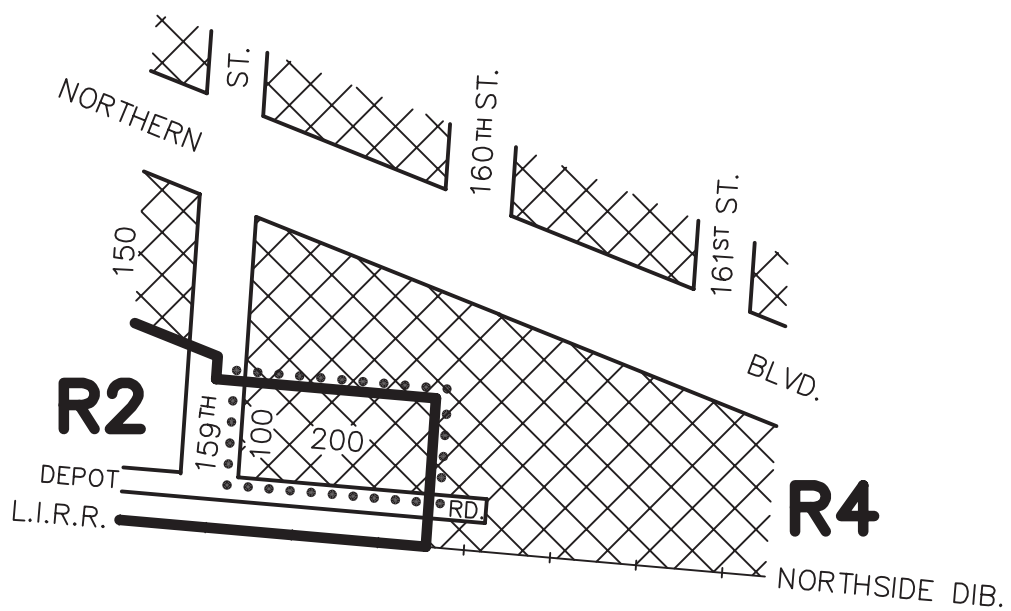



CITY PLANNING COMMISSION  
CITY OF NEW YORK

DIAGRAM SHOWING  
**ZONING CHANGE**  
ON SECTIONAL MAP  
**10c**  
BOROUGH OF  
**QUEENS**

EFFECTIVE DATE  
**June 8, 2005**  
C. C. RESO. # **465**



**NOTE:**

-  Indicates Zoning District boundary.
-  The area enclosed by the dotted line is rezoned by establishing a C1-2 District within an existing R2 District.
-  Indicates a C1-2 District.

THIS DIAGRAM IS FOR ILLUSTRATIVE PURPOSES ONLY.

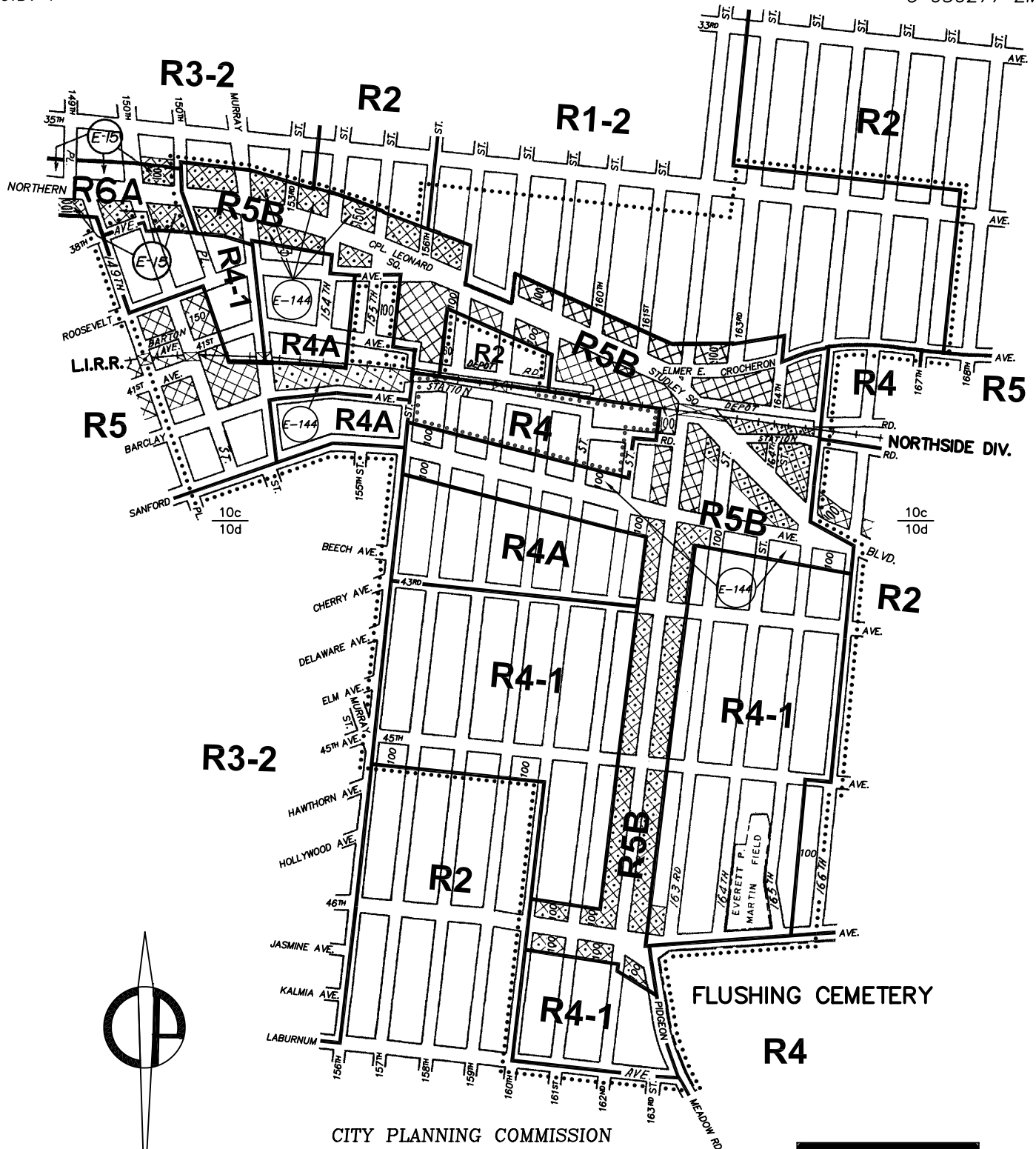



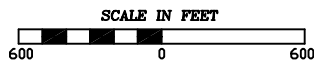

CITY PLANNING COMMISSION  
 CITY OF NEW YORK  
 DIAGRAM SHOWING  
**ZONING CHANGE**  
 ON SECTIONAL MAPS  
**10c & 10d**  
 BOROUGH OF  
**QUEENS**

EFFECTIVE DATE  
**July 27, 2005**  
 C. C. RESO. # 1094



**NOTE:**

-  Indicates Zoning District boundary.
-  The area enclosed by the dotted line is rezoned by eliminating C1-2 and C2-2 Districts and by changing R2, R3-2, R4, R5 and M1-1 Districts to R1-2, R2, R4-1, R4A, R5, and R5B Districts, and by establishing C1-2 and C2-2 Districts within the proposed R5 and R5B Districts.
-  Indicates a C1-2 District.
-  Indicates a C2-2 District.
-  Indicates a City Environmental Quality Review Declaration, refer to C.E.Q.R. sheet.

THIS DIAGRAM IS FOR ILLUSTRATIVE PURPOSES ONLY.

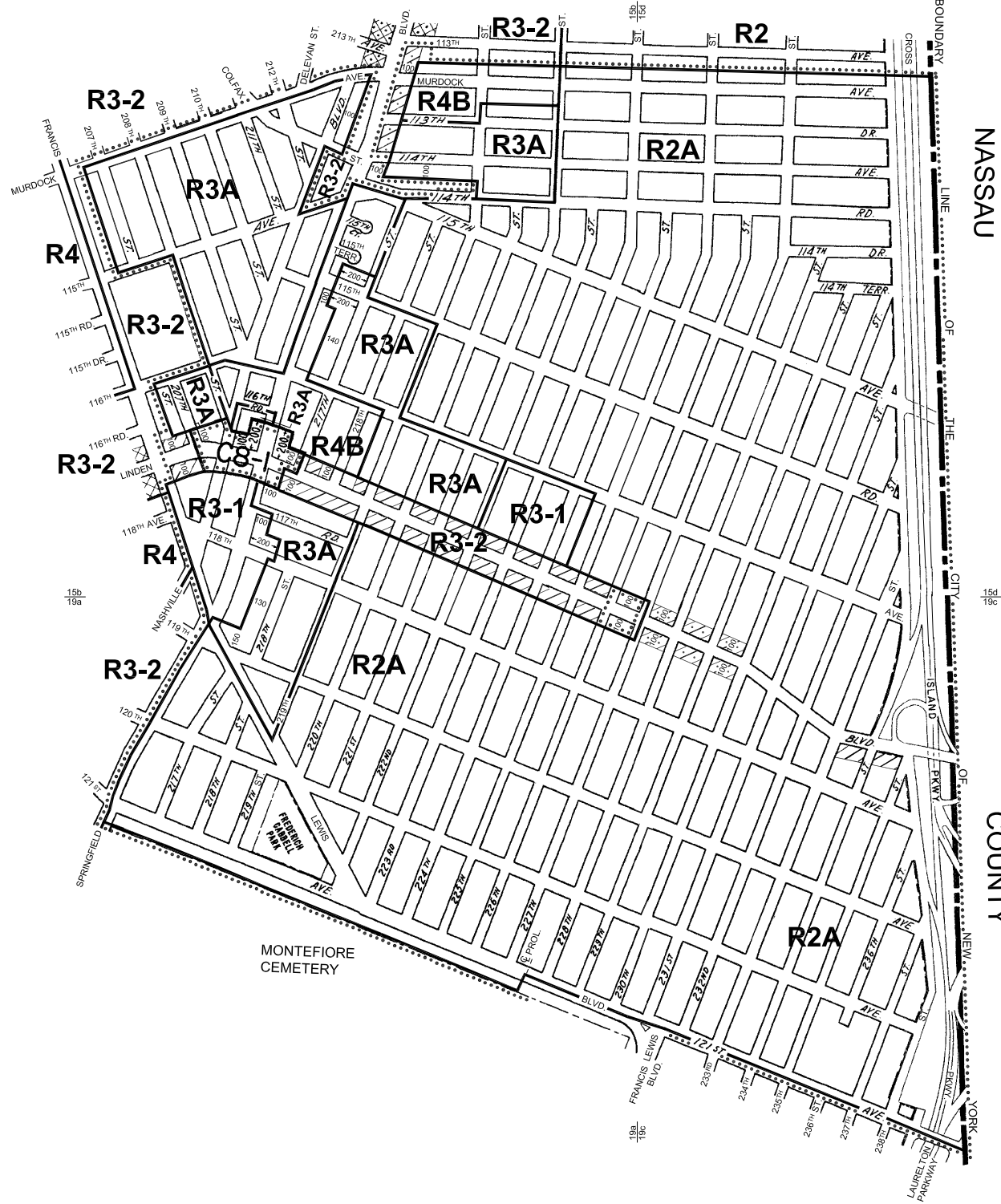

NASSAU COUNTY

NEW YORK COUNTY



CITY PLANNING COMMISSION  
 CITY OF NEW YORK  
 DIAGRAM SHOWING  
**ZONING CHANGE**  
 ON SECTIONAL MAPS  
**15b, 15d, 19a & 19c**  
 BOROUGH OF  
**QUEENS**

EFFECTIVE DATE  
**July 27, 2005**  
 C. C. RESO. # 1111

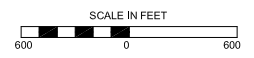

- NOTE:**
- Indicates Zoning District Boundary.
  - ..... The area enclosed by the dotted line is rezoned by eliminating a C1-2 and C2-2 Districts from within existing R2 and R3-2 Districts, by changing R2, R3-2 and R4 Districts to R2A, R3A, R3-1 and R4B Districts, and by establishing C1-3 and C2-3 Districts within existing R3-2 District and a proposed R2A District.
  - Indicates a C1-2 District.
  - Indicates a C1-3 District.
  - Indicates a C2-2 District.
  - Indicates a C2-3 District.

THIS DIAGRAM IS FOR ILLUSTRATIVE PURPOSES ONLY.

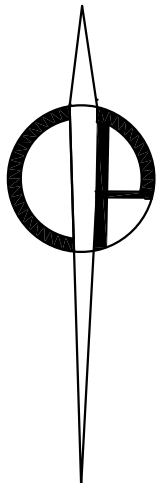
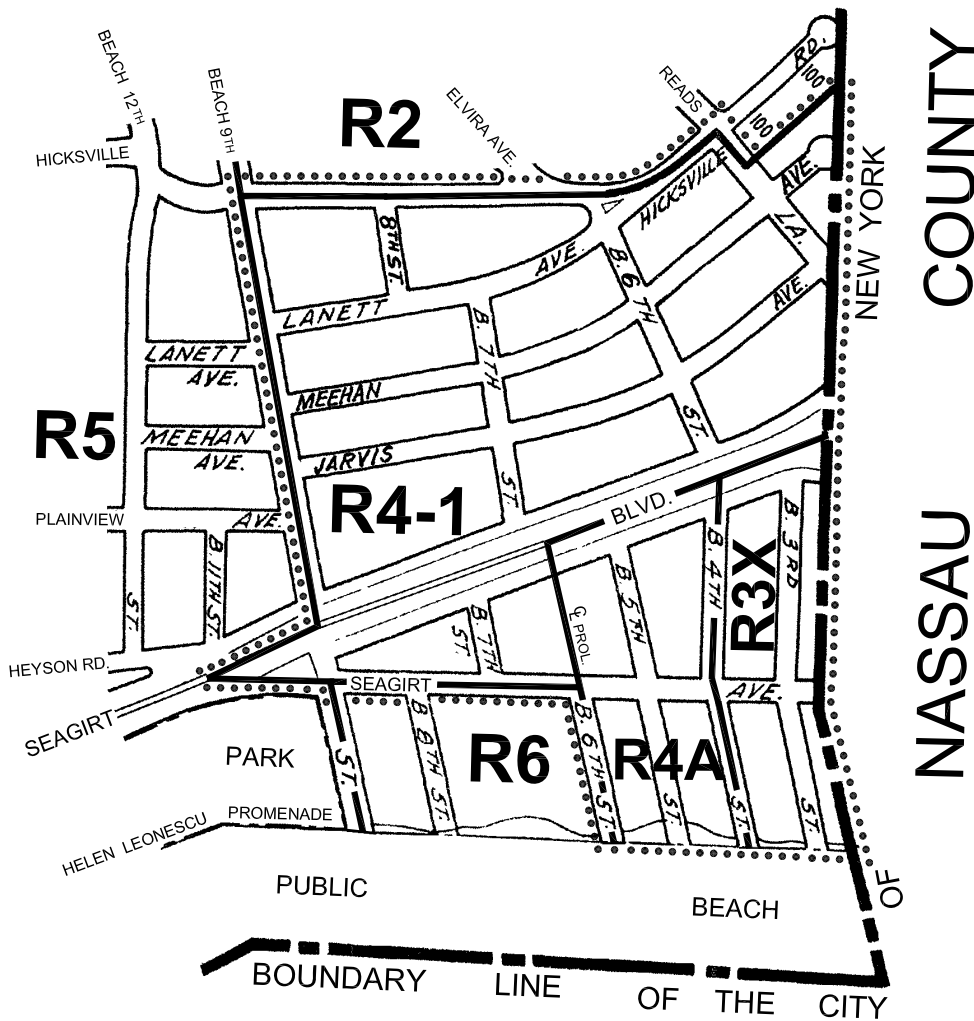

CITY PLANNING COMMISSION  
 CITY OF NEW YORK  
**ZONING CHANGE**  
 ON SECTIONAL MAP  
**31a**  
 BOROUGH OF  
**QUEENS**

EFFECTIVE DATE  
**September 15, 2005**  
 C. C. RESO. # 1162

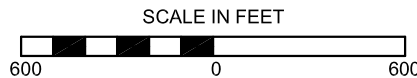

- NOTE:
- Indicates Zoning District Boundary.
  - The area enclosed by the dotted line is rezoned by changing R3-1 and R5 Districts to R3X, R4-1 and R4A Districts.

THIS DIAGRAM IS FOR ILLUSTRATIVE PURPOSES ONLY.

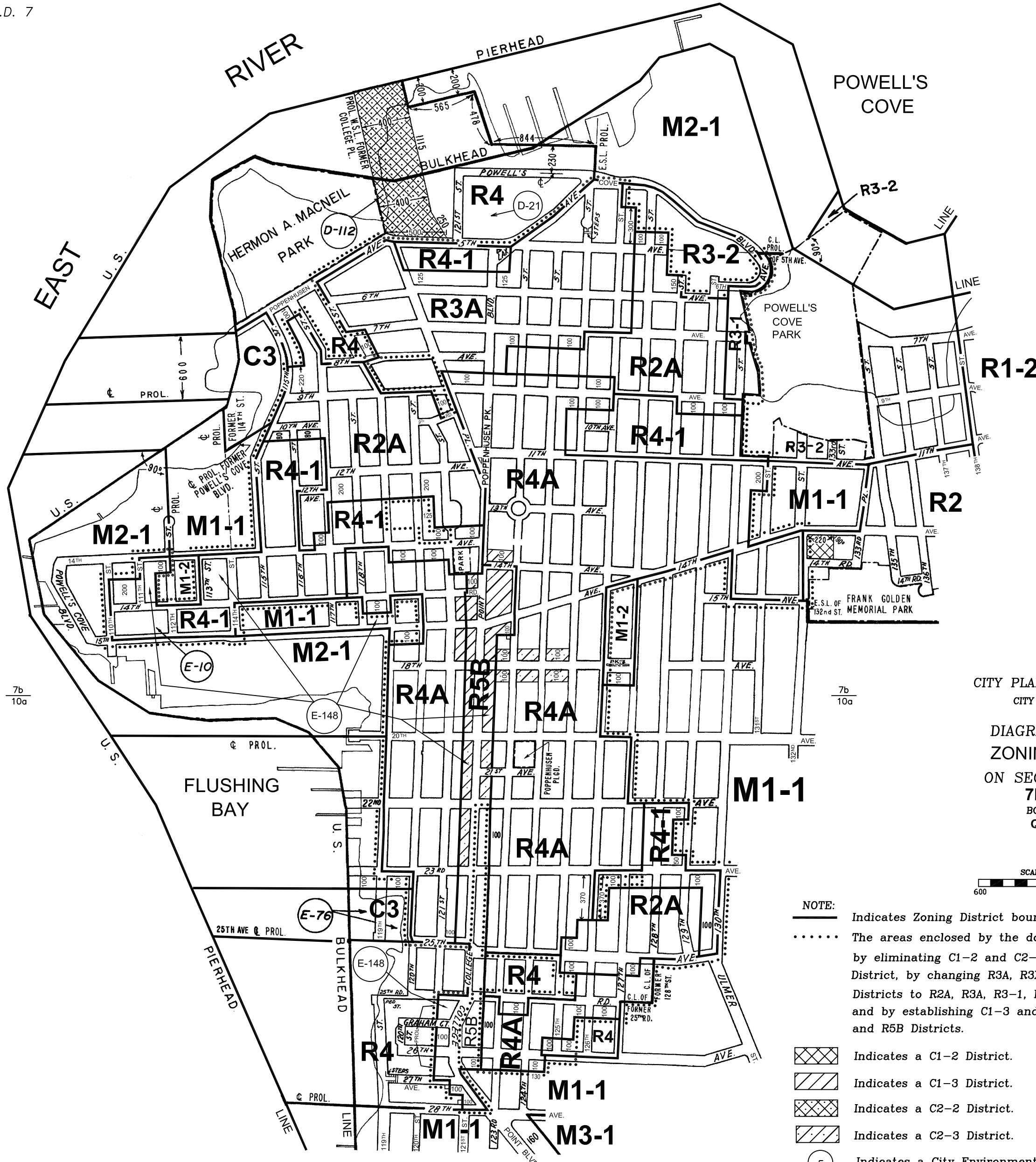

EFFECTIVE DATE  
**September 28, 2005**  
 C. C. RESO. # 1180

CITY PLANNING COMMISSION  
 CITY OF NEW YORK

DIAGRAM SHOWING  
 ZONING CHANGE  
 ON SECTIONAL MAPS  
**7b & 10a**  
 BOROUGH OF  
 QUEENS

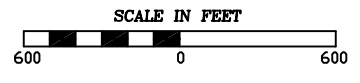
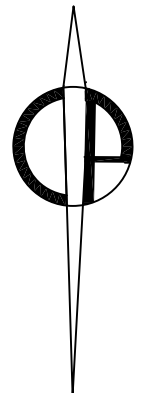

**NOTE:**

- Indicates Zoning District boundary.
- ..... The areas enclosed by the dotted lines are changed by eliminating C1-2 and C2-2 Districts from within an existing R4 District, by changing R3A, R3X, R3-2, R4, R4-1, M1-1 and M2-1 Districts to R2A, R3A, R3-1, R4, R4A, R4-1, R5B and M1-2 Districts, and by establishing C1-3 and C2-3 Districts within R4A and R5B Districts.

- Indicates a C1-2 District.
- Indicates a C1-3 District.
- Indicates a C2-2 District.
- Indicates a C2-3 District.

- Indicates a City Environmental Quality Review Declaration, refer to C.E.Q.R. sheet.
- Indicates a Restrictive Declaration Area, refer to R.D. sheet.

THIS DIAGRAM IS FOR ILLUSTRATIVE PURPOSES ONLY.



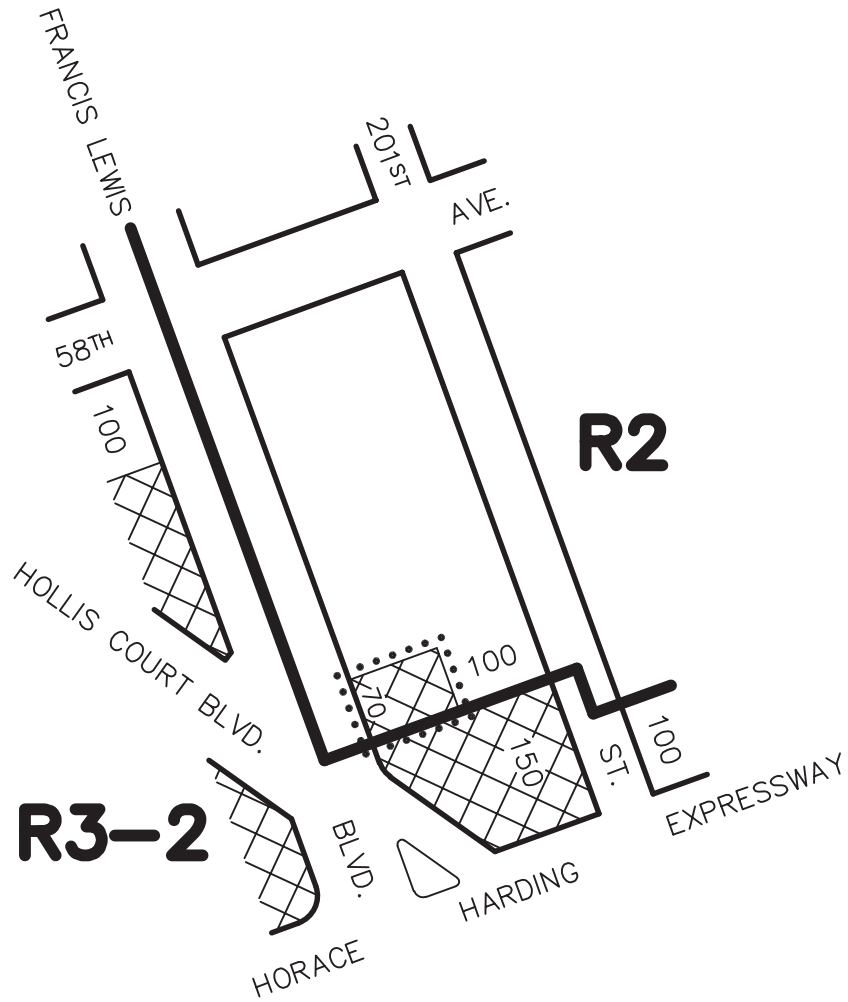



CITY PLANNING COMMISSION  
 CITY OF NEW YORK  
 DIAGRAM SHOWING  
 ZONING CHANGE  
 ON SECTIONAL MAP  
 11b  
 BOROUGH OF  
 QUEENS

EFFECTIVE DATE  
**September 28, 2005**  
 C. C. RESO. # 1184



NOTE:

-  Indicates Zoning District boundary.
-  The area enclosed by the dotted line is rezoned by establishing a C1-2 District within an existing R2 District.
-  Indicates a C1-2 District.



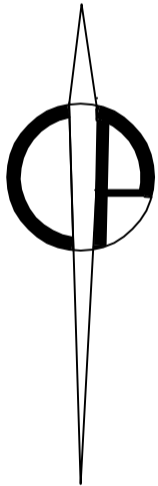
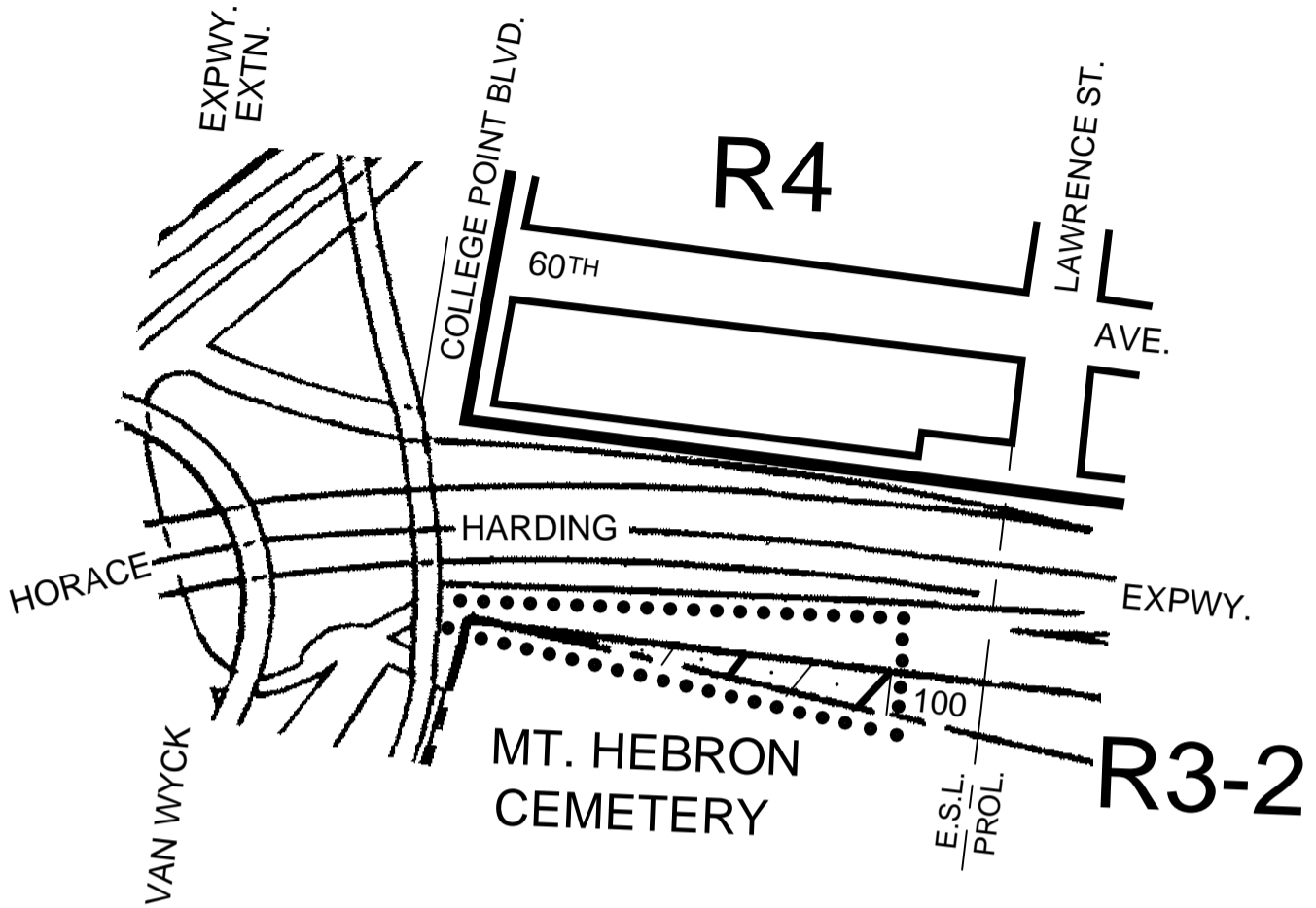

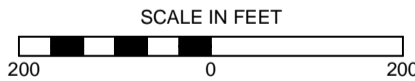

CITY PLANNING COMMISSION  
 CITY OF NEW YORK  
 DIAGRAM SHOWING  
**ZONING CHANGE**  
 ON SECTIONAL MAP  
**10b**  
 BOROUGH OF  
**QUEENS**

EFFECTIVE DATE  
**October 27, 2005**  
 C. C. RESO. # 1235



- NOTE:**
-  Indicates Zoning District Boundary.
  -  The area enclosed by the dotted line is rezoned by establishing a C2-3 District within an existing R3-2 District.
  -  Indicates a C2-3 District.

THIS DIAGRAM IS FOR ILLUSTRATIVE PURPOSES ONLY.

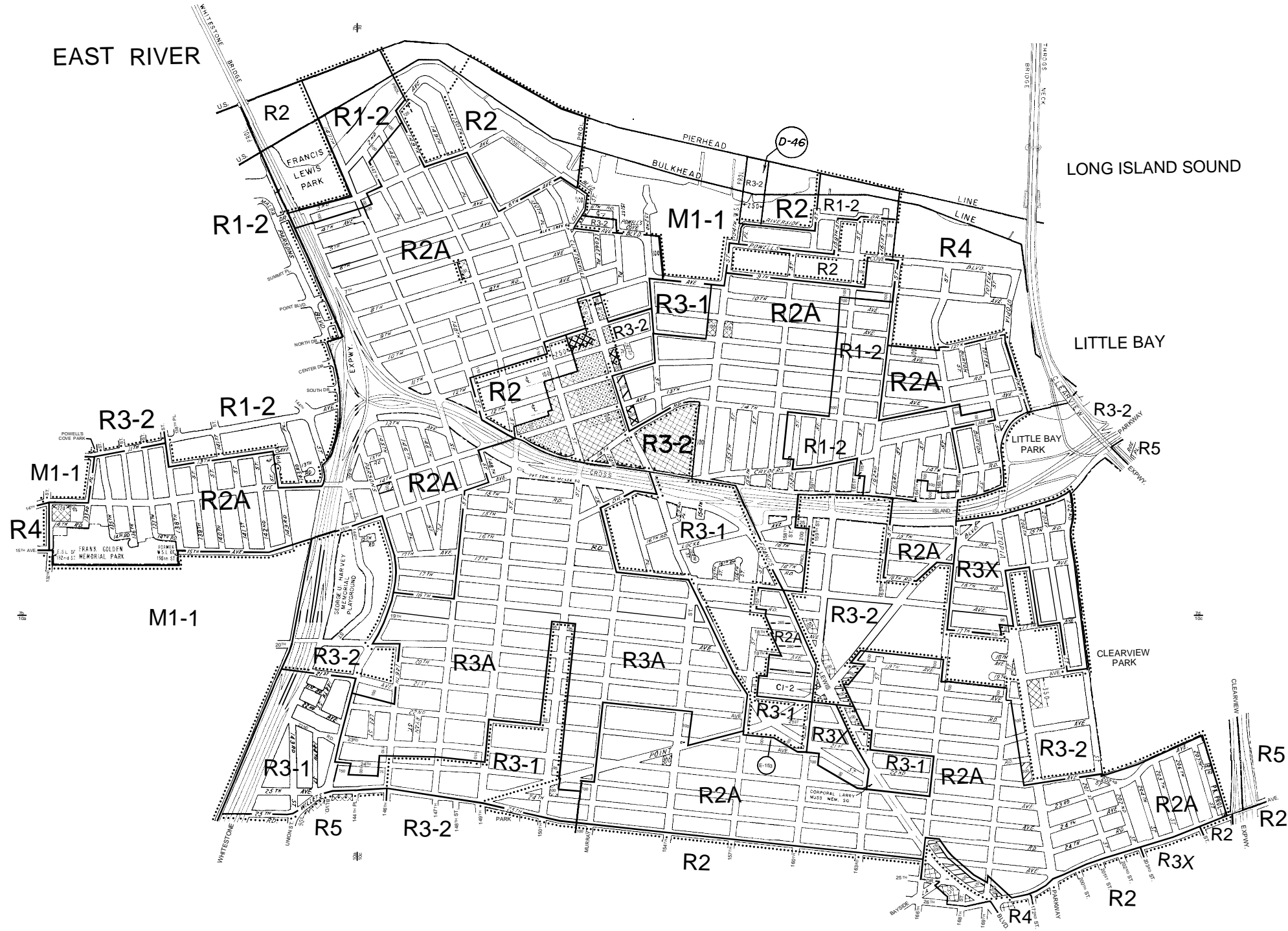

CITY PLANNING COMMISSION  
 CITY OF NEW YORK  
 DIAGRAM SHOWING  
**ZONING CHANGE**  
 ON SECTIONAL MAPS  
**7b, 7d, 10a & 10c**  
 BOROUGH OF  
**QUEENS**

EFFECTIVE DATE  
 December 21, 2005  
 C. C. RESO. # 1309



- NOTE:
- ..... Indicates Restrictive District Boundary.
  - ..... The areas enclosed by the dotted lines are rezoned by eliminating C1-2 and C2-2 Districts from within existing R2, R3-2 and R4 Districts, and by changing R2, R3-1 and R3-2 Districts to R2, R2A, R3-1, R3-2, R3A and R3X Districts, and by establishing C1-2, C1-3, and C2-2 Districts within existing and adopted R2A, R3-2 and R4 Districts.
  - ▨ Indicates a C1-2 District.
  - ▧ Indicates a C1-3 District.
  - ▩ Indicates a C2-2 District.
  - (D) Indicates a Restrictive Declaration Area, refer to R.D. sheet.
  - (E) Indicates a City Environmental Quality Review Declaration, refer to C.E.Q.R. sheet.

THIS DIAGRAM IS FOR ILLUSTRATIVE PURPOSES ONLY.



CITY PLANNING COMMISSION  
CITY OF NEW YORK  
DIAGRAM SHOWING  
**ZONING CHANGE**  
ON SECTIONAL MAPS  
**13c, 13d & 14b**  
BOROUGH OF  
**QUEENS**

EFFECTIVE DATE  
**March 22, 2006**  
C. C. RESO. # 211

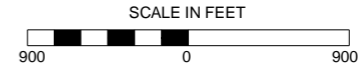

- NOTE:
- Indicates Zoning District Boundary.
  - ..... The areas enclosed by the dotted lines are rezoned by eliminating C1-2 and C2-2 Districts from within existing R4 and R5 Districts, by changing R4, R5 and M1-1 Districts to R3X, R4A, R4B, R4-1 and R5B Districts, and by establishing C1-3 and C2-3 Districts within an existing R5 District and adopted R4B, R4-1 and R5B Districts.

- Indicates a C1-2 District.
- Indicates a C1-3 District.
- Indicates a C2-2 District.
- Indicates a C2-3 District.

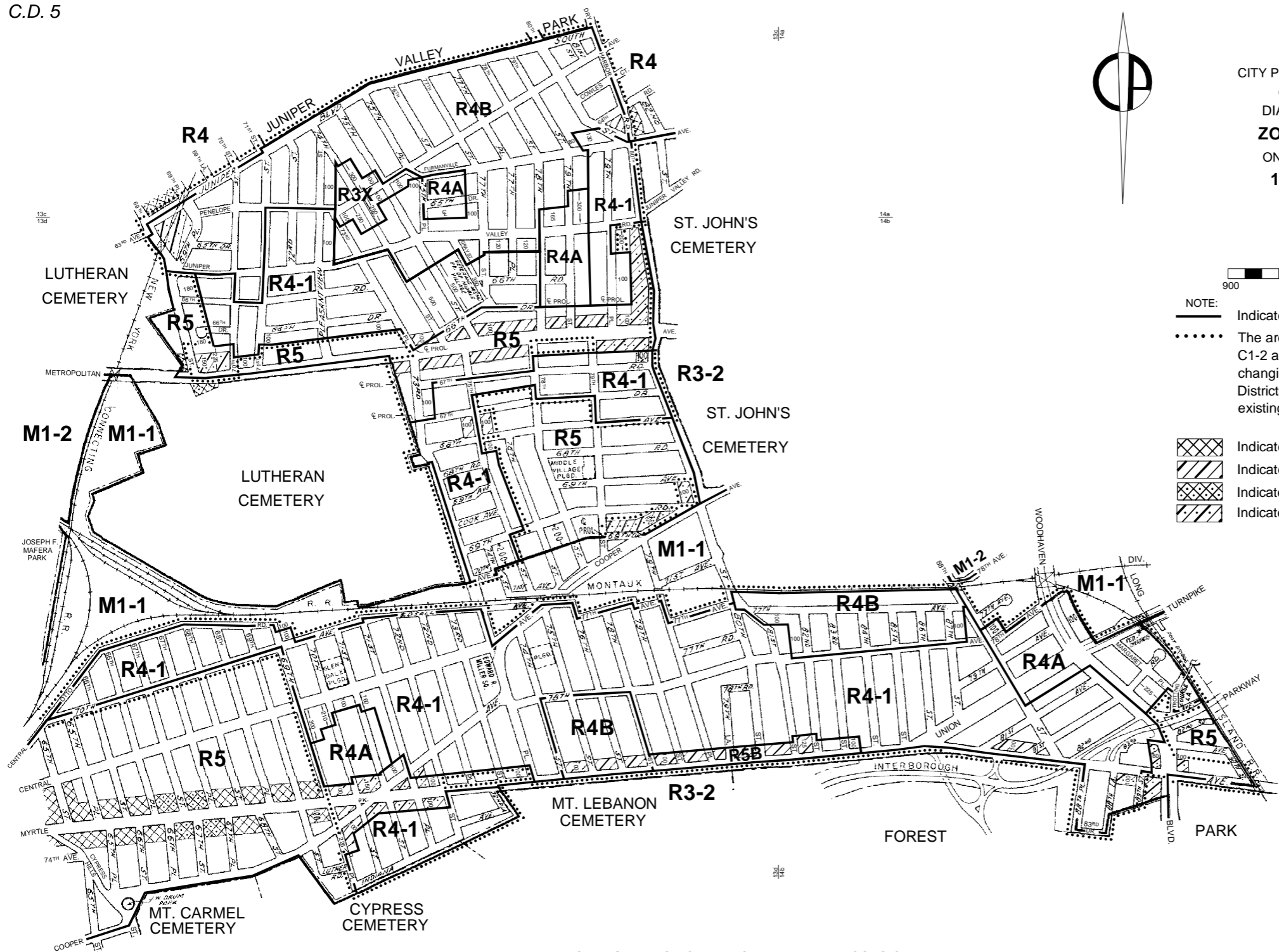

THIS DIAGRAM IS FOR ILLUSTRATIVE PURPOSES ONLY.

Sketch Corrected 4/5/06

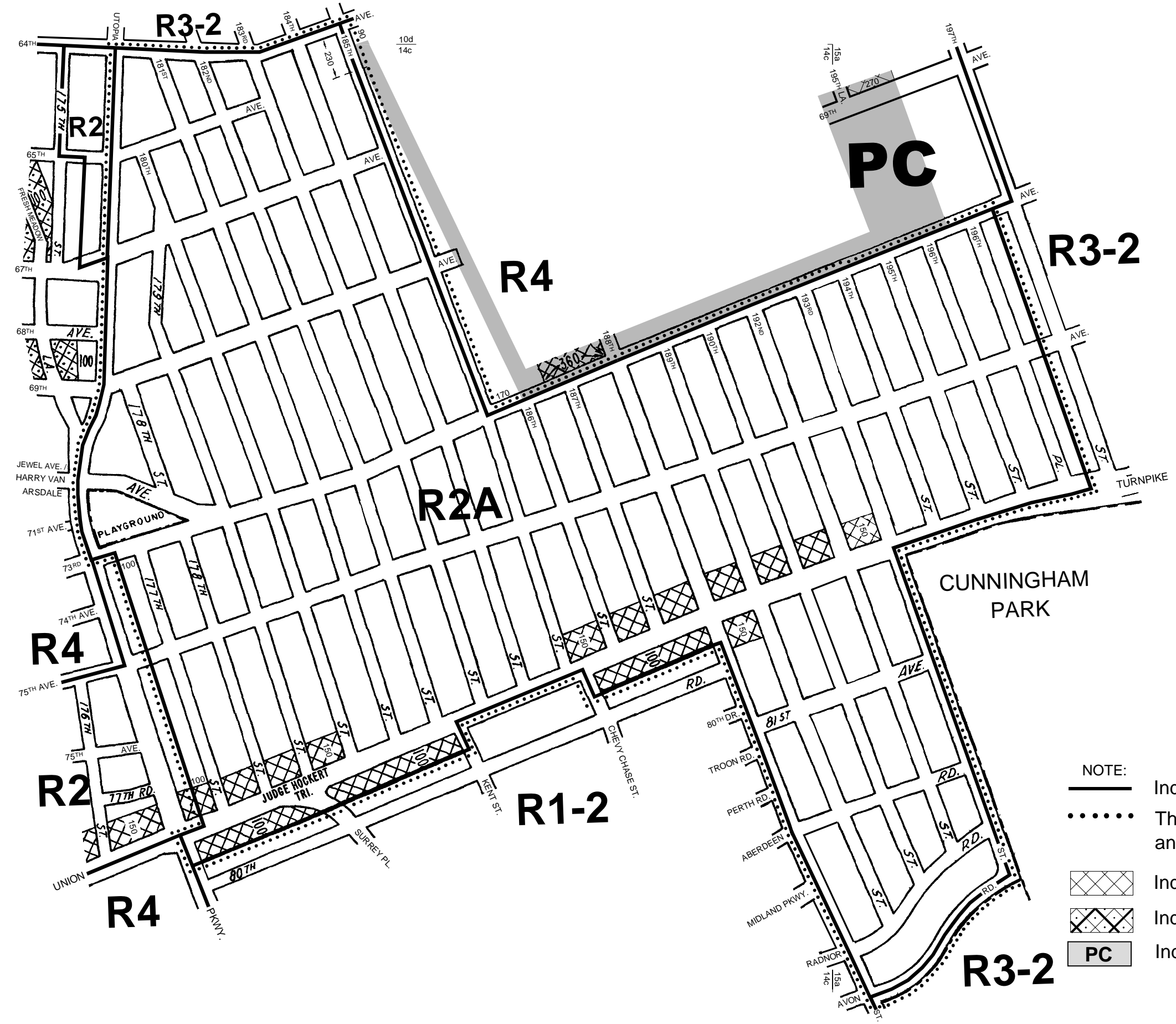

CITY PLANNING COMMISSION  
 CITY OF NEW YORK  
 DIAGRAM SHOWING  
**ZONING CHANGE**  
 ON SECTIONAL MAP  
**10d, 14c & 15a**  
 BOROUGH OF  
**QUEENS**



EFFECTIVE DATE  
 April 5, 2006  
 C. C. RESO. # 240

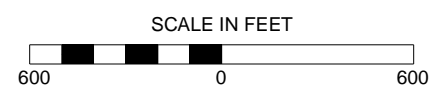

- NOTE:
- Indicates Zoning District Boundary.
  - The area enclosed by the dotted line is rezoned by changing an R2 District to an R2A District.
  - ▤ Indicates a C1-2 District.
  - ▥ Indicates a C2-2 District.
  - PC Indicates a Special Planned Community Preservation District.

THIS DIAGRAM IS FOR ILLUSTRATIVE PURPOSES ONLY.

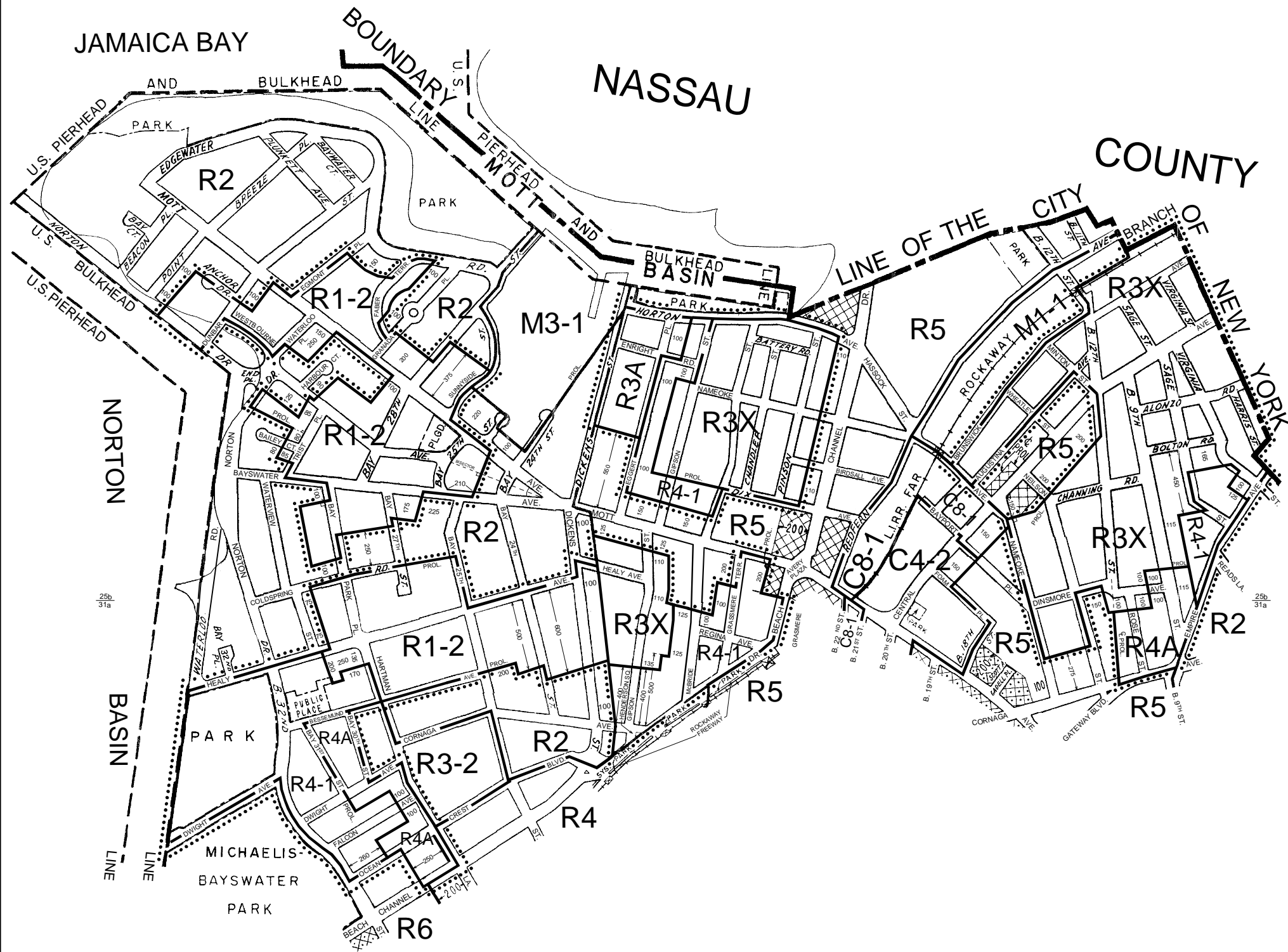

CITY PLANNING COMMISSION  
 CITY OF NEW YORK  
 DIAGRAM SHOWING  
**ZONING CHANGE**  
 ON SECTIONAL MAPS  
**25b & 31a**  
 BOROUGH OF  
**QUEENS**



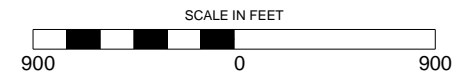



EFFECTIVE DATE  
 April 26, 2006  
 C. C. RESO. # 282

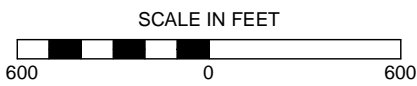
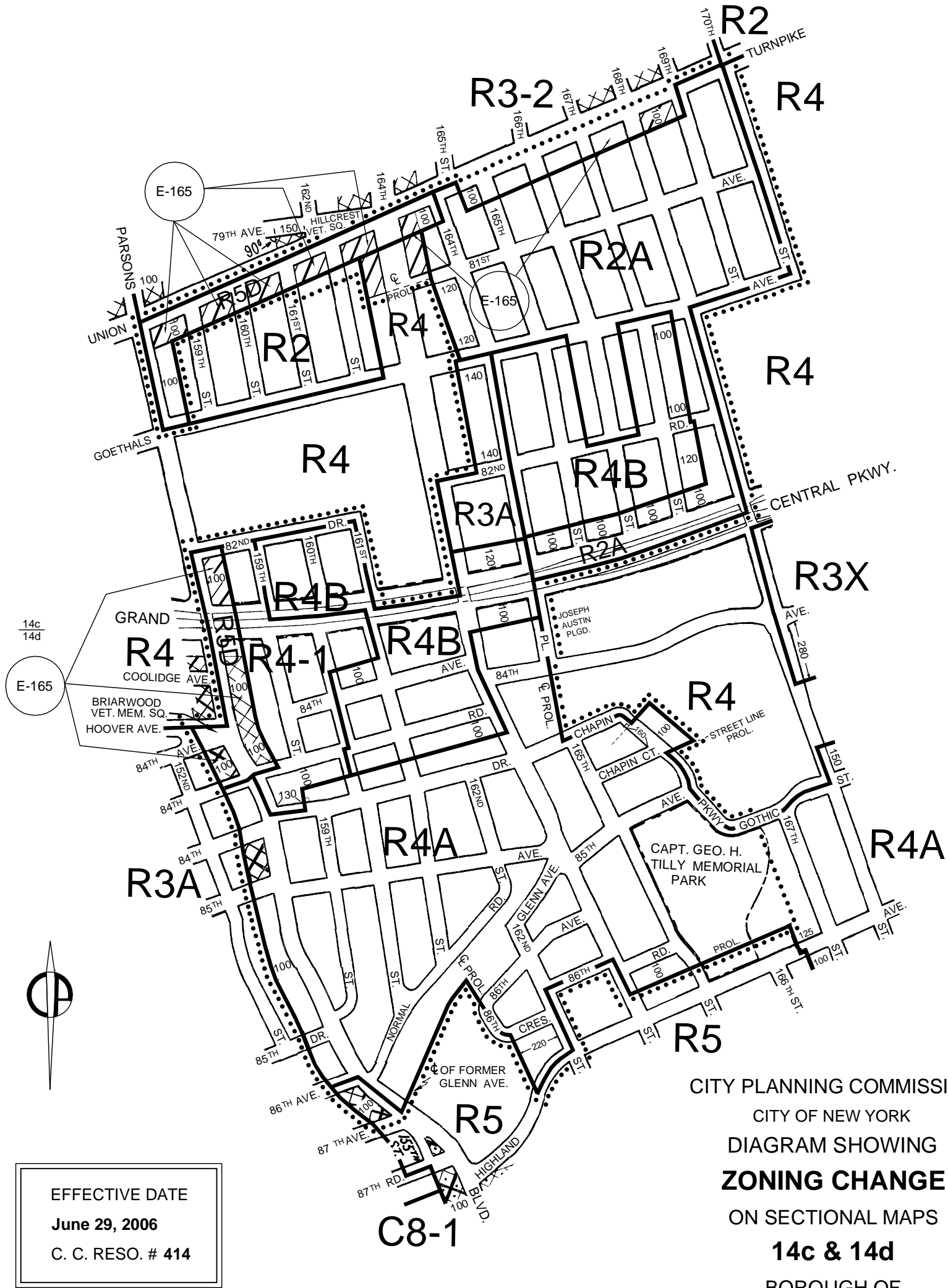

- NOTE:
- Indicates Zoning District Boundary.
  - ..... The areas enclosed by the dotted lines are rezoned by changing R2, R3-2, R4, R5 and R6 Districts to R1-2, R3A, R3X, R4A and R4-1 Districts.
  - ▨ Indicates a C1-2 District.
  - ▩ Indicates a C2-2 District.

THIS DIAGRAM IS FOR ILLUSTRATIVE PURPOSES ONLY.



- NOTE:**
-  Indicates Zoning District Boundary.
  -  The areas enclosed by the dotted lines are rezoned by eliminating C1-2 Districts from within existing R2, R3-2, and R4 Districts, by changing R2, R3-2, R4 and R5 Districts to R2, R2A, R3A, R3-2, R4A, R4B, R4-1, R5 and R5D Districts, and by establishing C1-3 Districts within adopted R5D Districts.
  -  Indicates a C1-2 District.
  -  Indicates a C1-3 District.
  -  Indicates a C1-4 District.
  -  Indicates a C2-4 District.
  -  Indicates a City Environmental Quality Review Declaration, refer to C.E.Q.R. sheet.

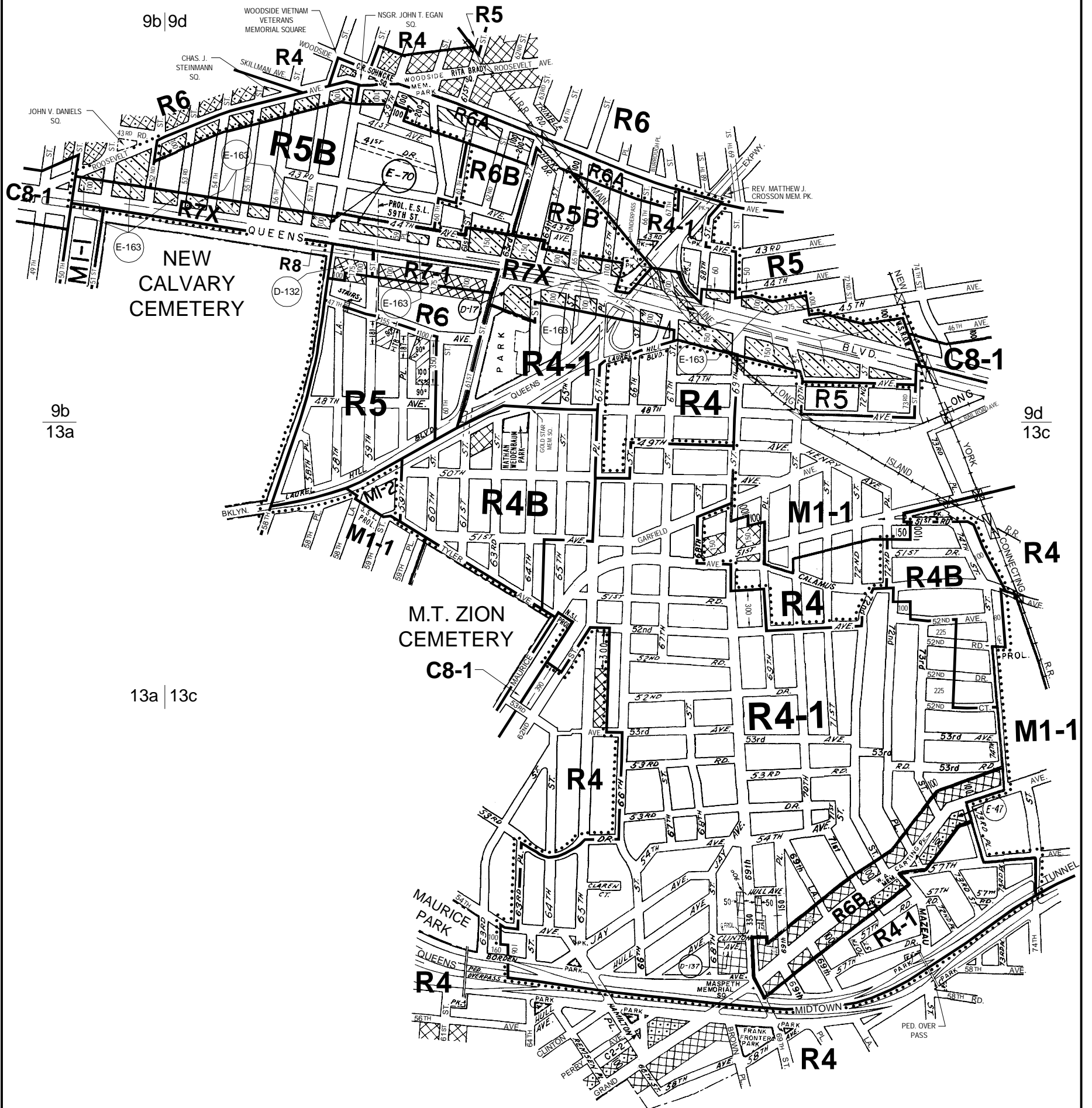



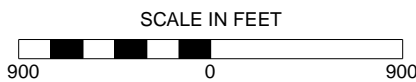



CITY PLANNING COMMISSION  
 CITY OF NEW YORK  
 DIAGRAM SHOWING  
**ZONING CHANGE**  
 ON SECTIONAL MAP  
**9b, 9d & 13c**  
 BOROUGH OF  
**QUEENS**



EFFECTIVE DATE  
**June 29, 2006**  
 C. C. RESO. # 423

**NOTE:**

-  Indicates Zoning District Boundary.
-  The areas enclosed by the dotted lines are rezoned by eliminating C2-2 Districts from within existing R4, R5, R5B, R6 and R7X Districts, by changing R4, R5, R5B, R6, R6B, C8-1 and M1-1 Districts to R4B, R4-1, R5, R5B, R6 and R7X Districts, and by establishing C2-3 Districts within adopted R6 and R7X Districts.
-  Indicates a C1-2 District.
-  Indicates a C2-2 District.
-  Indicates a C2-3 District.
-  Indicates a City Environmental Quality Review Declaration, refer to C.E.Q.R. sheet.

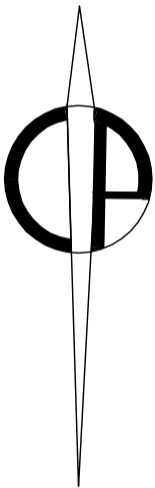
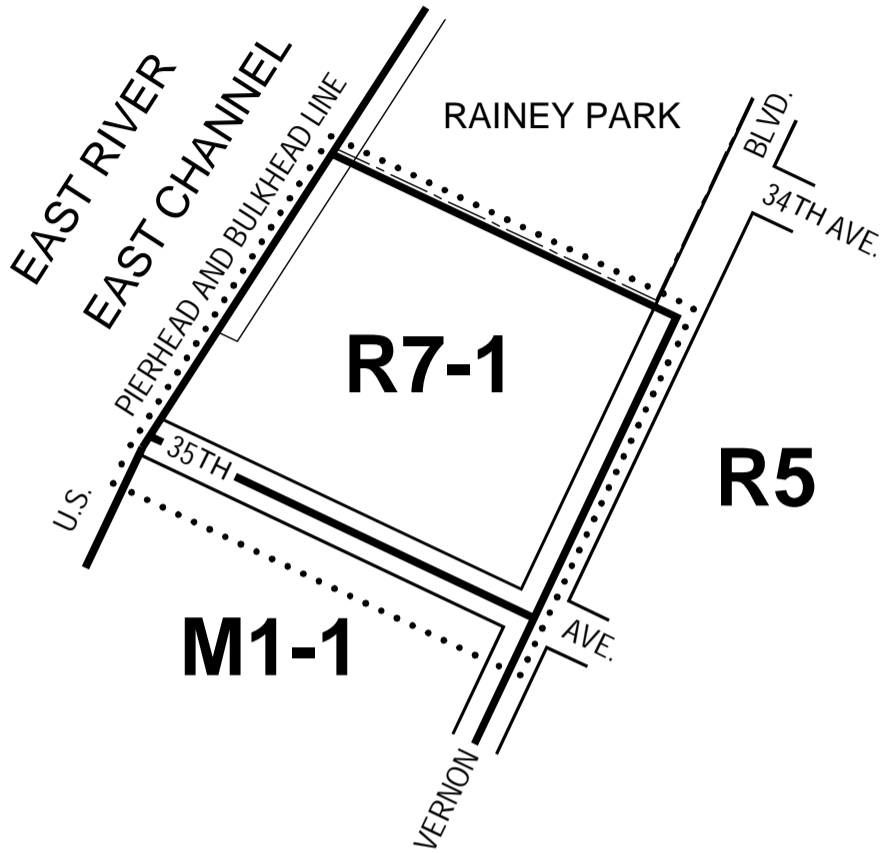

CITY PLANNING COMMISSION  
CITY OF NEW YORK

DIAGRAM SHOWING  
**ZONING CHANGE**  
ON SECTIONAL MAP

**9a**  
BOROUGH OF  
QUEENS

EFFECTIVE DATE <b>July 19, 2006</b> C. C. RESO. # <b>448</b>
--

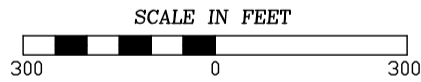

**NOTE:**

- Indicates Zoning District boundary.
- ..... The area enclosed by the dotted line is rezoned by changing an R5 District to R7-1 and M1-1 Districts.

THIS DIAGRAM IS FOR ILLUSTRATIVE PURPOSES ONLY.



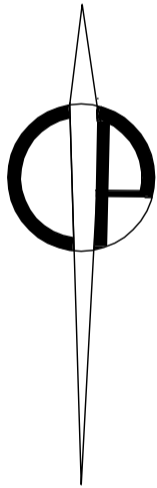
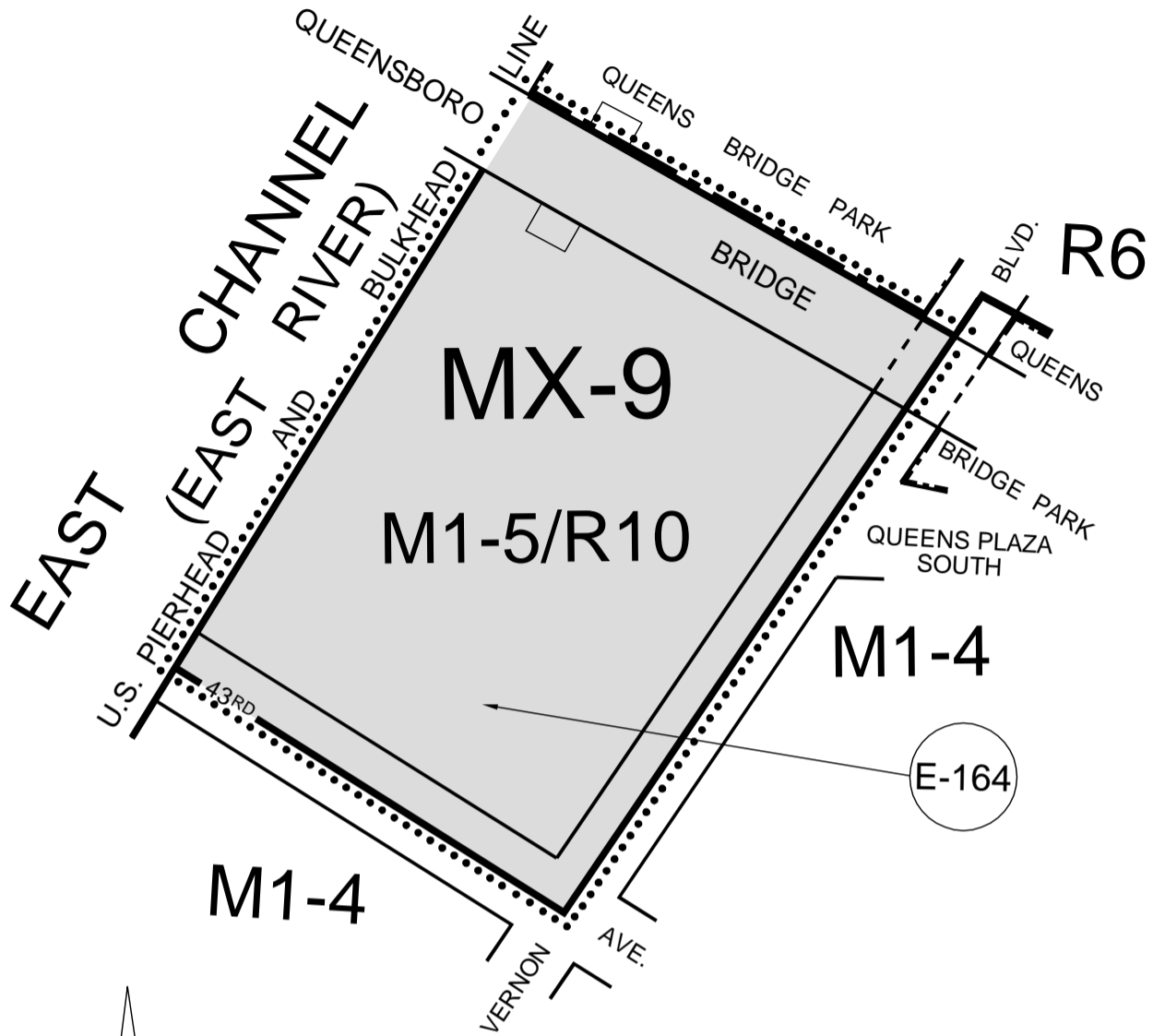

CITY PLANNING COMMISSION  
 CITY OF NEW YORK  
 DIAGRAM SHOWING  
**ZONING CHANGE**  
 ON SECTIONAL MAP  
**9b**  
 BOROUGH OF  
**QUEENS**

EFFECTIVE DATE  
**August 16, 2006**  
 C. C. RESO. # 477

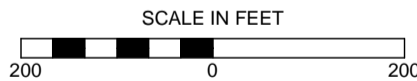

- NOTE:
- Indicates Zoning District Boundary.
  - The area enclosed by the dotted line is rezoned by changing an M1-4 District to M1-5/R10 District and by establishing a Special Mixed Use District (MX-9).
  - Indicates a Special Mixed Use District (MX-9).
  - Indicates a City Environmental Quality Review Declaration, refer to C.E.Q.R. sheet.



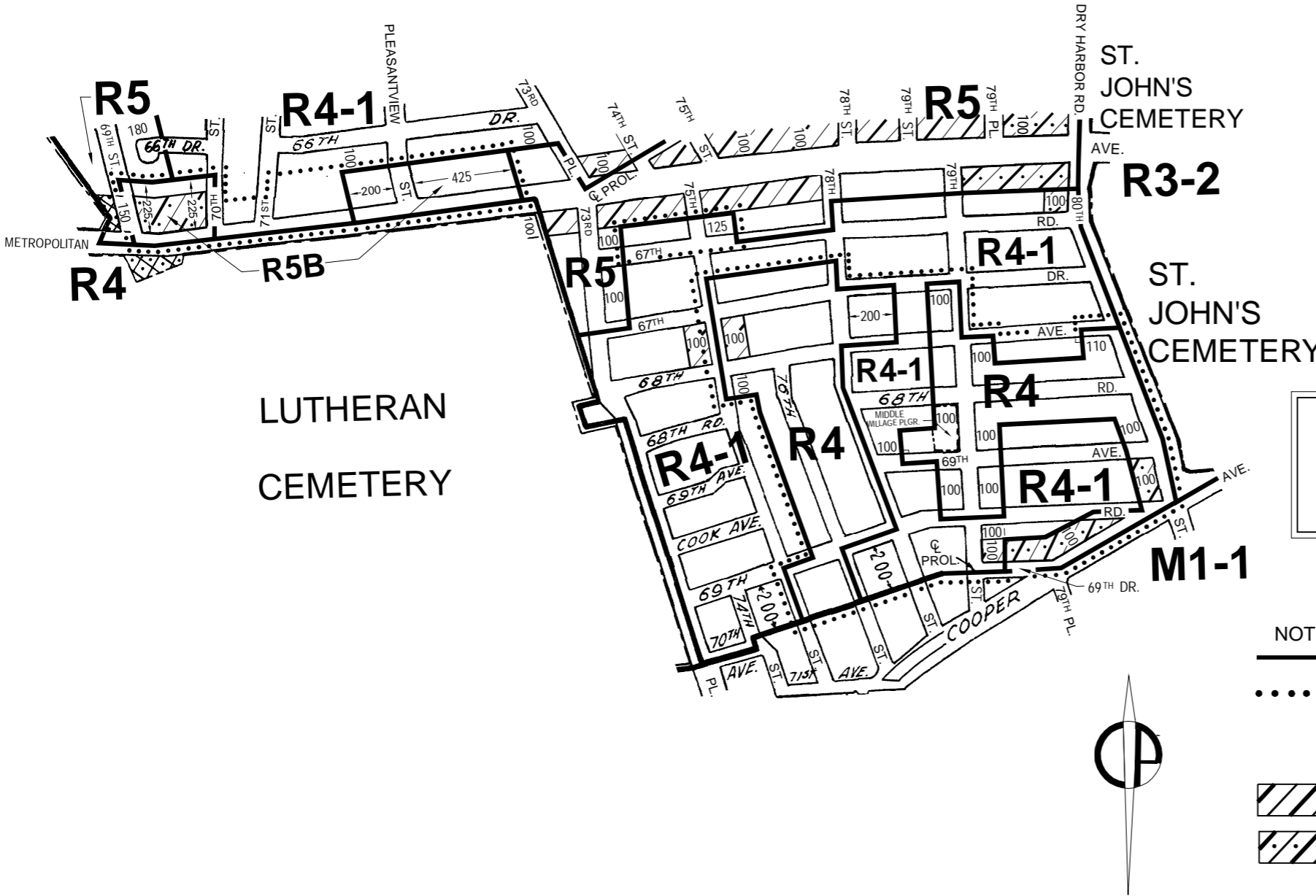

THIS DIAGRAM IS FOR ILLUSTRATIVE PURPOSES ONLY.

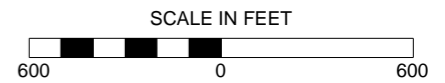

CITY PLANNING COMMISSION  
 CITY OF NEW YORK  
 DIAGRAM SHOWING  
**ZONING CHANGE**  
 ON SECTIONAL MAP  
**13d**  
 BOROUGH OF  
**QUEENS**

EFFECTIVE DATE  
**August 16, 2006**  
 C. C. RESO. # 483



- NOTE:**
-  Indicates Zoning District Boundary.
  -  The areas enclosed by the dotted lines are rezoned by changing from an R5 District to R4, R4-1 and R5B Districts.
  -  Indicates a C1-3 District.
  -  Indicates a C2-3 District.

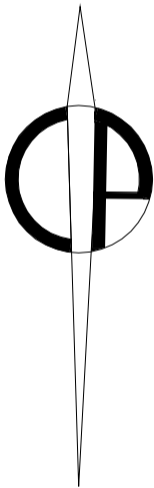
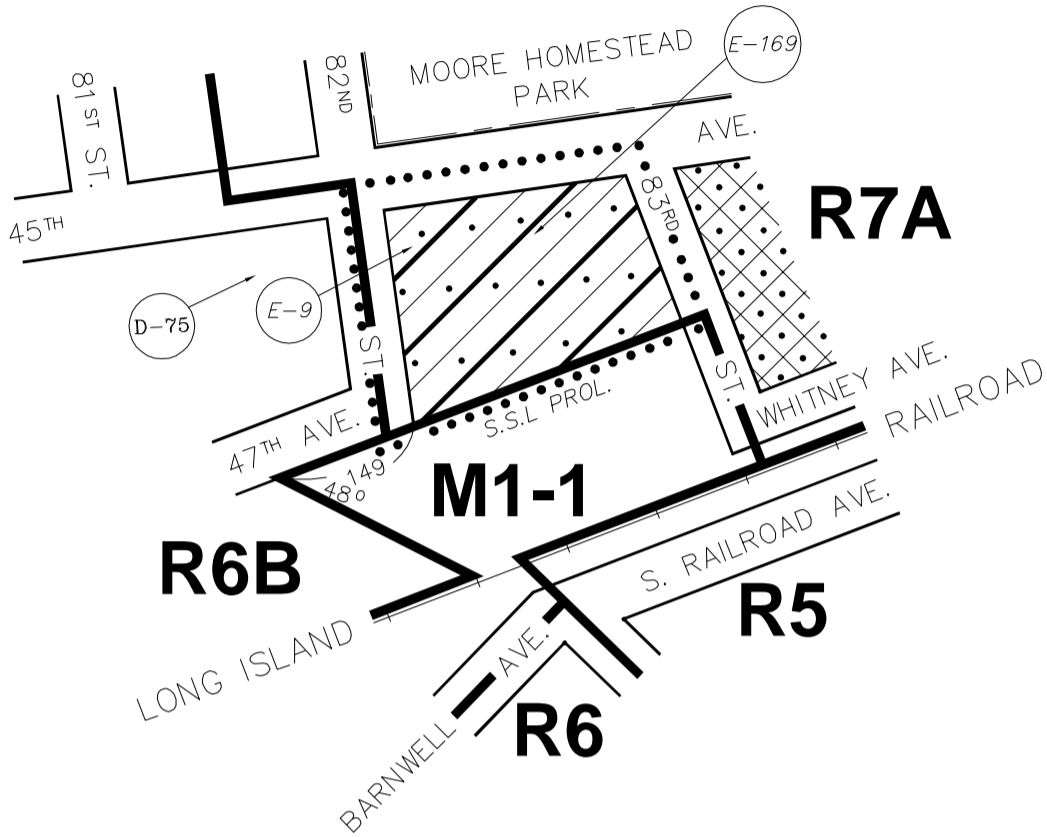

CITY PLANNING COMMISSION  
CITY OF NEW YORK





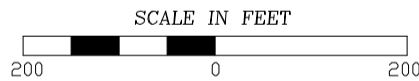

DIAGRAM SHOWING  
**ZONING CHANGE**  
ON SECTIONAL MAP

**9d**  
BOROUGH OF  
**QUEENS**

EFFECTIVE DATE  
**November 15, 2006**  
C. C. RESO. # **621**



**NOTE:**

-  Indicates Zoning District boundary.
-  The area enclosed by the dotted line is rezoned by changing an R6B District to an R7A District and by establishing a C2-3 District within the adopted R7A District.
-  Indicates a C2-2 District.
-  Indicates a C2-3 District.
-  Indicates a City Environmental Quality Review Declaration, refer to C.E.Q.R. sheet.
-  Indicates a Restrictive Declaration Area, refer to R.D. sheet.

THIS DIAGRAM IS FOR ILLUSTRATIVE PURPOSES ONLY.



CITY PLANNING COMMISSION  
 CITY OF NEW YORK  
 DIAGRAM SHOWING  
**ZONING CHANGE**  
 ON SECTIONAL MAPS  
**11a, 11b, 11c & 11d**  
 BOROUGH OF  
**QUEENS**

EFFECTIVE DATE  
**December 20, 2006**  
 C. C. RESO. # 677

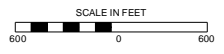

- NOTE:
- Indicates Zoning District Boundary.
  - ..... The areas enclosed by the dotted lines are rezoned by eliminating C1-2 and C2-2 Districts from within existing R1-2, R3-1 and R4 Districts changing from R1-2, R2, R3-1, R3-2, R4 and C3 Districts to R1-1, R1-2, R2, R2A, R3X, R3-1 and R4-1 Districts.
  - ▨ Indicates a C1-2 District.
  - ▩ Indicates a C2-2 District.

THIS DIAGRAM IS FOR ILLUSTRATIVE PURPOSES ONLY.

CITY PLANNING COMMISSION  
 CITY OF NEW YORK  
 DIAGRAM SHOWING  
**ZONING CHANGE**  
 ON SECTIONAL MAP  
**10b, 10d & 14a**  
 BOROUGH OF  
**QUEENS**

EFFECTIVE DATE  
**February 28, 2007**  
 C. C. RESO. # 737

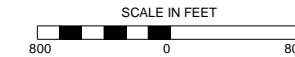

NOTE:

— Indicates Zoning District Boundary.

..... The areas enclosed by the dotted lines are rezoned by eliminating C1-2 and C2-2 Districts within an existing R4 District, and changing from R2, R3-2, R4 Districts to R2A, R3-1, R3A, R3X, R4, R4-1, R4A, R4B and R5B Districts, and by establishing C1-3 and C2-3 Districts within proposed R5B Districts.



Indicates a C1-2 District.



Indicates a C1-3 District.



Indicates a C2-3 District.



Indicates a City Environmental Quality Review Declaration, refer to C.E.Q.R. sheet.



Indicates a Restrictive Declaration Area, refer to R.D. sheet.

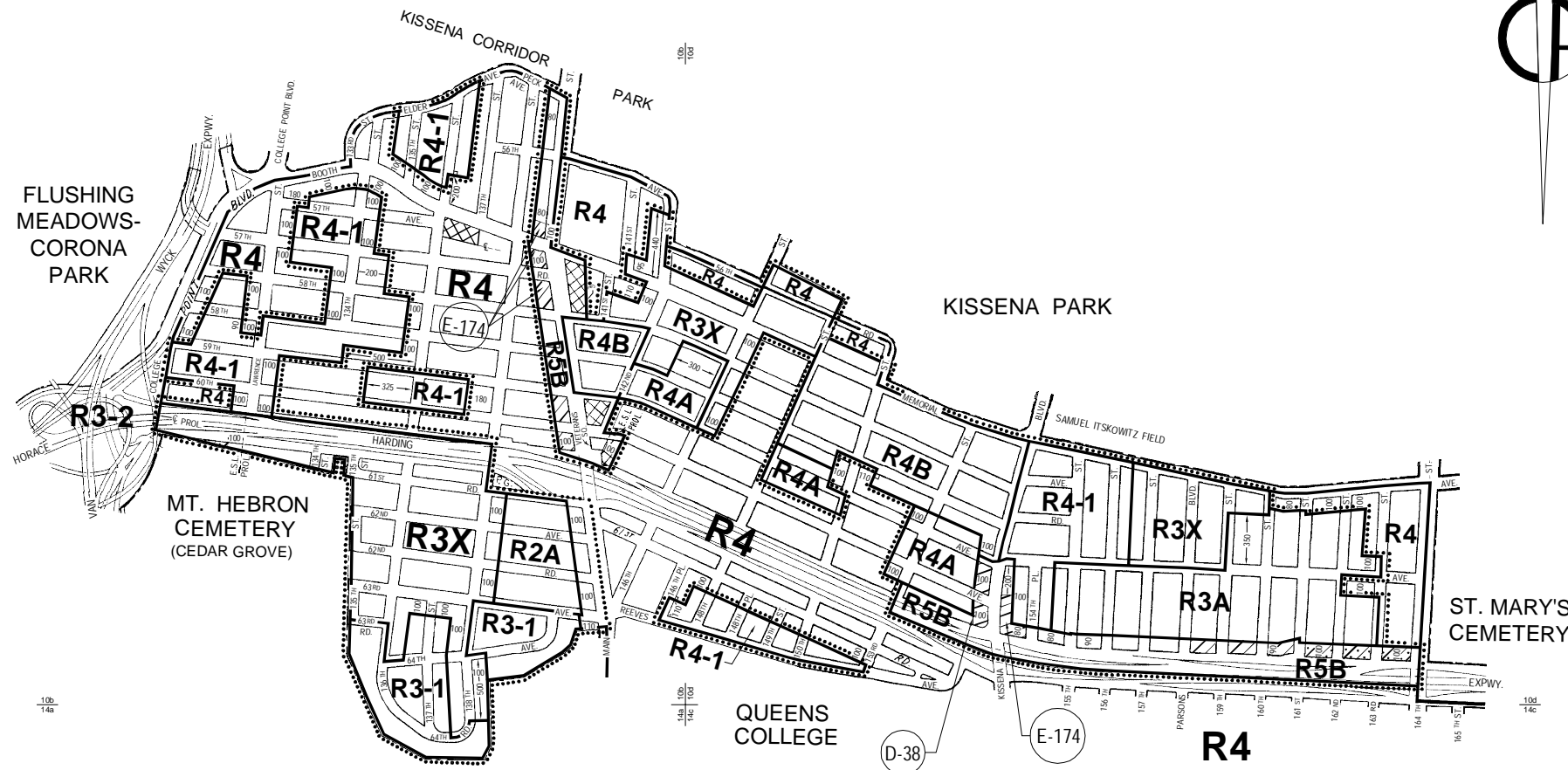

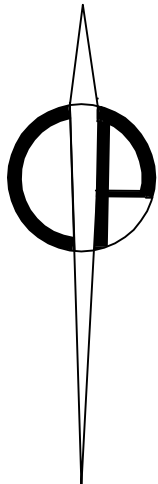
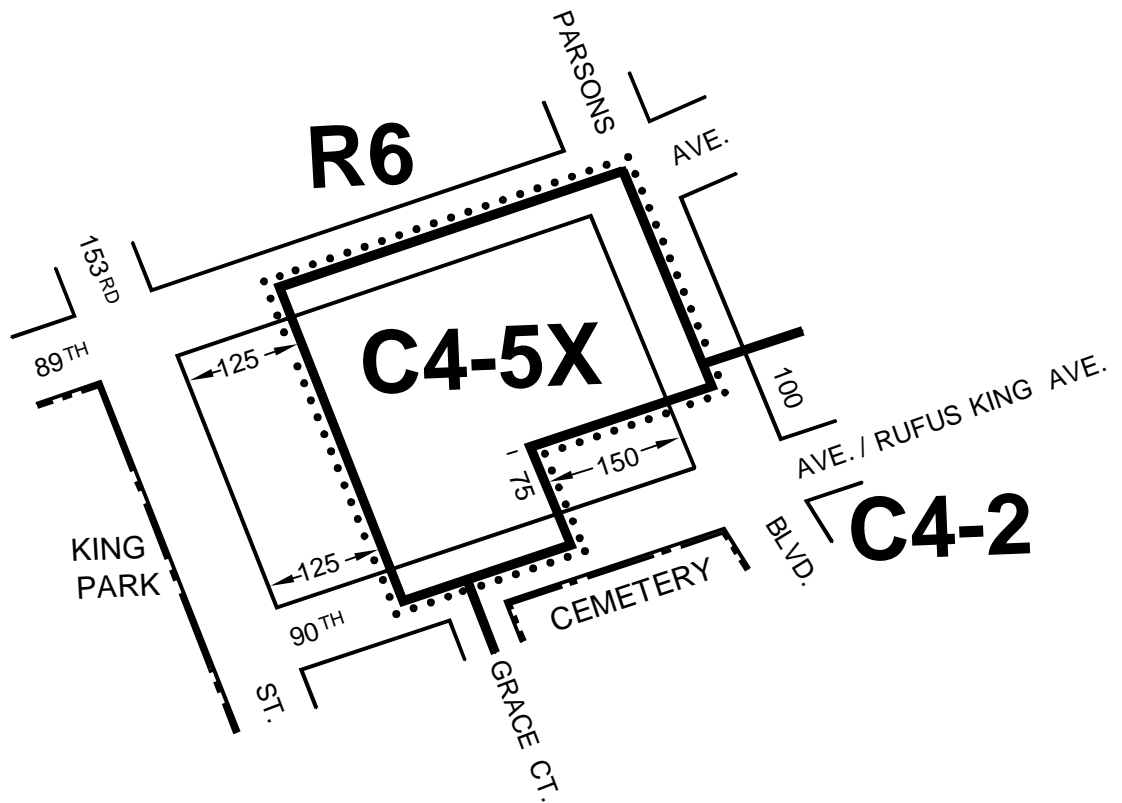

CITY PLANNING COMMISSION  
 CITY OF NEW YORK  
**ZONING CHANGE**  
 ON SECTIONAL MAP  
**14d**  
 BOROUGH OF  
**QUEENS**

EFFECTIVE DATE  
**March 14, 2007**  
 C. C. RESO. # 753

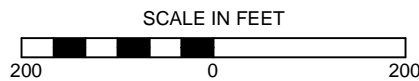

- NOTE:**
- Indicates Zoning District Boundary.
  - .....** The area enclosed by the dotted line is rezoned by changing R6 and C4-2 Districts to a C4-5X District.



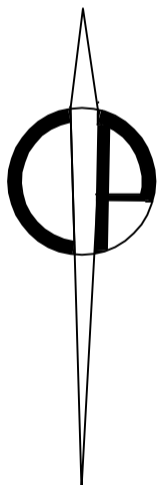
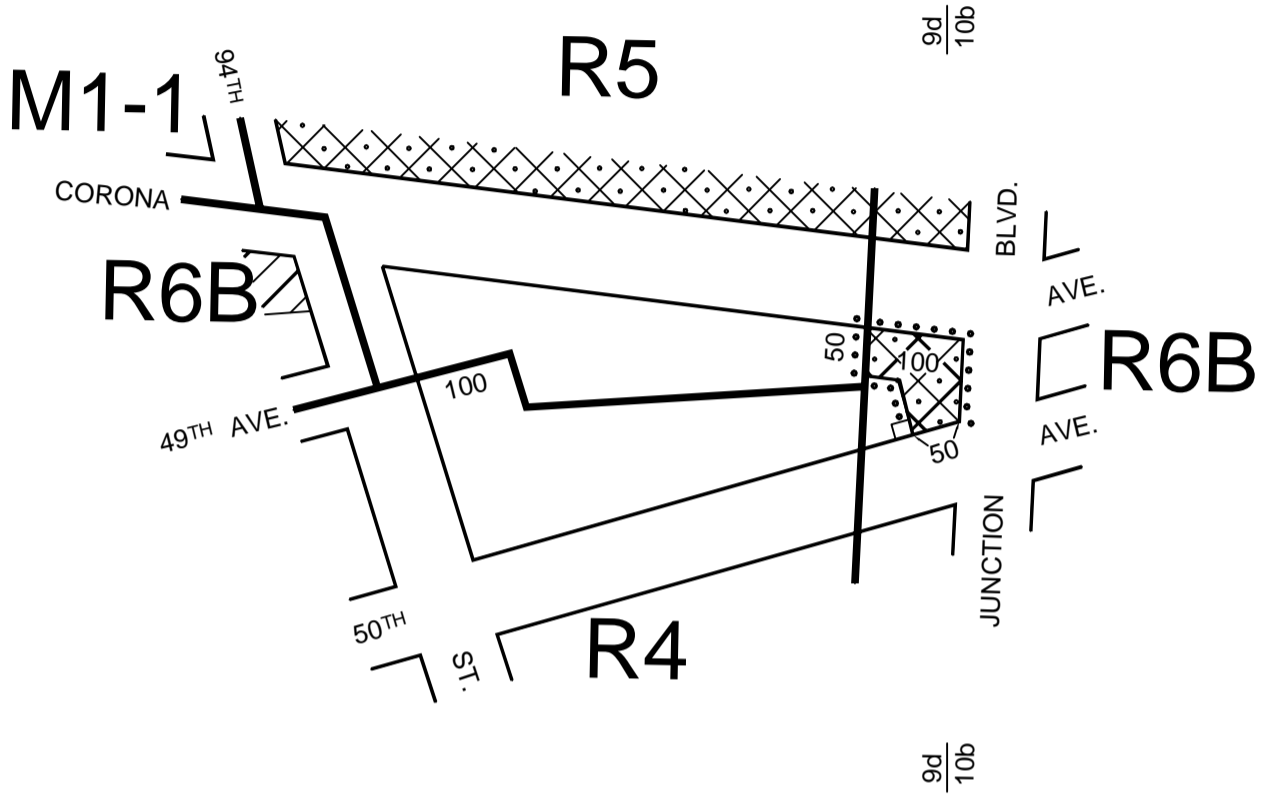

THIS DIAGRAM IS FOR ILLUSTRATIVE PURPOSES ONLY.

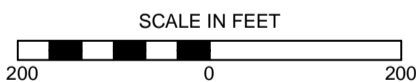

CITY PLANNING COMMISSION  
 CITY OF NEW YORK  
 DIAGRAM SHOWING  
**ZONING CHANGE**  
 ON SECTIONAL MAPS  
**9d & 10b**  
 BOROUGH OF  
**QUEENS**

EFFECTIVE DATE  
**April 23, 2007**  
 C. C. RESO. # 835



- NOTE:
-  Indicates Zoning District Boundary.
  -  The area enclosed by the dotted line is rezoned by establishing a C2-4 District within an existing R6B District.
  -  Indicates a C1-3 District.
  -  Indicates a C2-2 District.
  -  Indicates a C2-4 District.

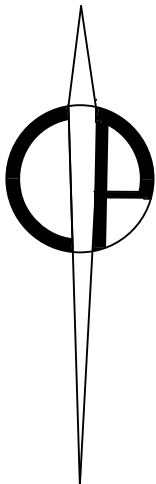
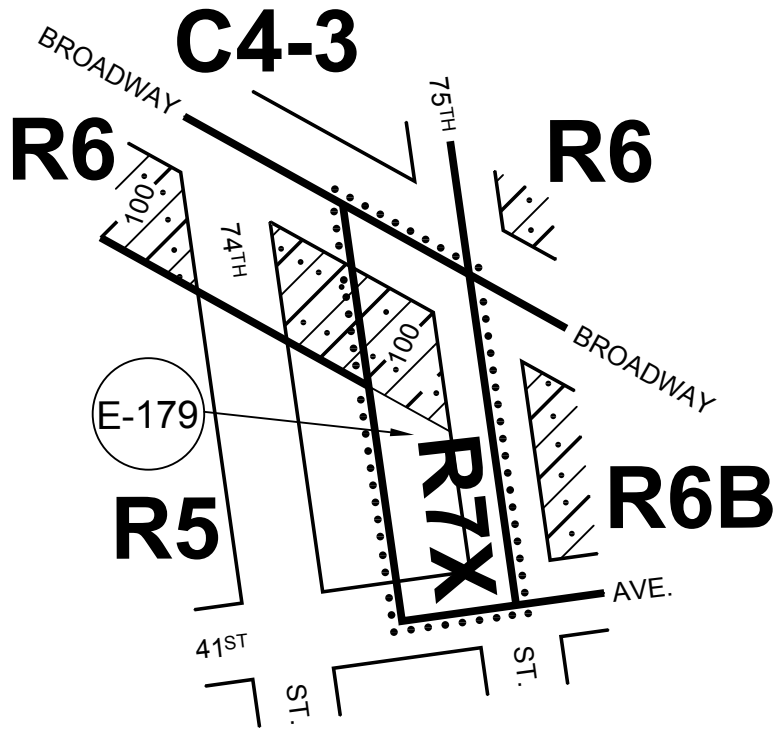



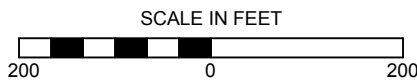

CITY PLANNING COMMISSION  
 CITY OF NEW YORK  
**ZONING CHANGE**  
 ON SECTIONAL MAP  
**9d**  
 BOROUGH OF  
**QUEENS**

EFFECTIVE DATE  
**August 22, 2007**  
 C. C. RESO. # 1027



NOTE:

-  Indicates Zoning District Boundary.
-  The area enclosed by the dotted line is proposed to be rezoned by changing from an R6B District to an R7X District.
-  Indicates a C2-3 District.
-  Indicates a City Environmental Quality Review Declaration, refer to C.E.Q.R. sheet.

THIS DIAGRAM IS FOR ILLUSTRATIVE PURPOSES ONLY.



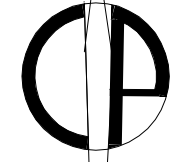
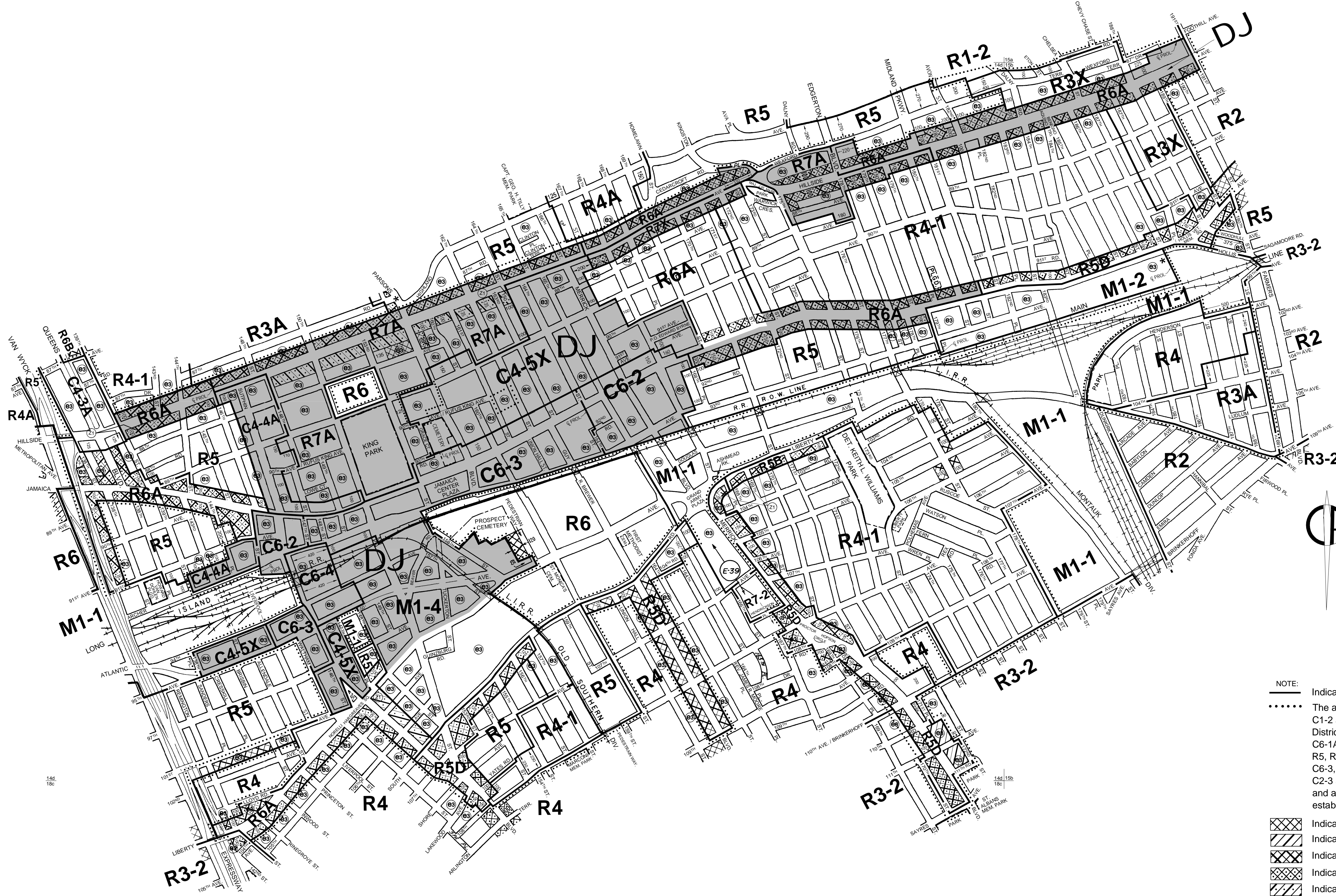

CITY PLANNING COMMISSION  
 CITY OF NEW YORK  
 DIAGRAM SHOWING PROPOSED  
**ZONING CHANGE**  
 ON SECTIONAL MAPS  
**14d, 15a, 15b & 18c**  
 BOROUGH OF  
**QUEENS**

EFFECTIVE DATE  
**September 10, 2007**  
 C. C. RESO. # 1051

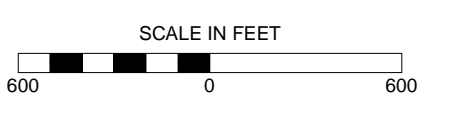

- NOTE:**
- Indicates Zoning District Boundary.
  - ..... The areas enclosed by the dotted lines are rezoned by eliminating C1-2 and C2-2 Districts from within existing R3-2, R4, R5 and R6 Districts, by changing R2, R3-2, R4, R5, R6, C4-2, C4-6, C6-1, C6-1A, C8-1, M1-1 and M1-5 Districts to R1-2, R3A, R3X, R4-1, R5, R5B, R5D, R6A, R7A, R7X, C4-3A, C4-4A, C4-5X, C6-2, C6-3, C6-4, M1-1, M1-2, and M1-4, by establishing C1-3, C1-4, C2-3 and C2-4 Districts within an existing R3-2 and R5 Districts and adopted R5B, R5D, R6A, R7A and R7X District, and by establishing a Special Downtown Jamaica District.
  - [Cross-hatch pattern] Indicates a C1-2 District.
  - [Diagonal lines /] Indicates a C1-3 District.
  - [Diagonal lines \] Indicates a C1-4 District.
  - [Cross-hatch pattern] Indicates a C2-2 District.
  - [Diagonal lines /] Indicates a C2-3 District.
  - [Diagonal lines \] Indicates a C2-4 District.
  - [DJ symbol] Indicates a Special Downtown Jamaica District.
  - [Circle with E-39] Indicates a City Environmental Quality Review Declaration E-175, refer to C.E.Q.R. sheet.
  - [Circle with Z1] Refer to Zoning Resolution, Section 11-151.
  - [Star symbol] As Corrected 10-03-07

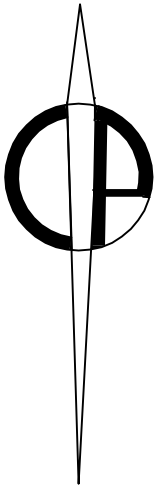
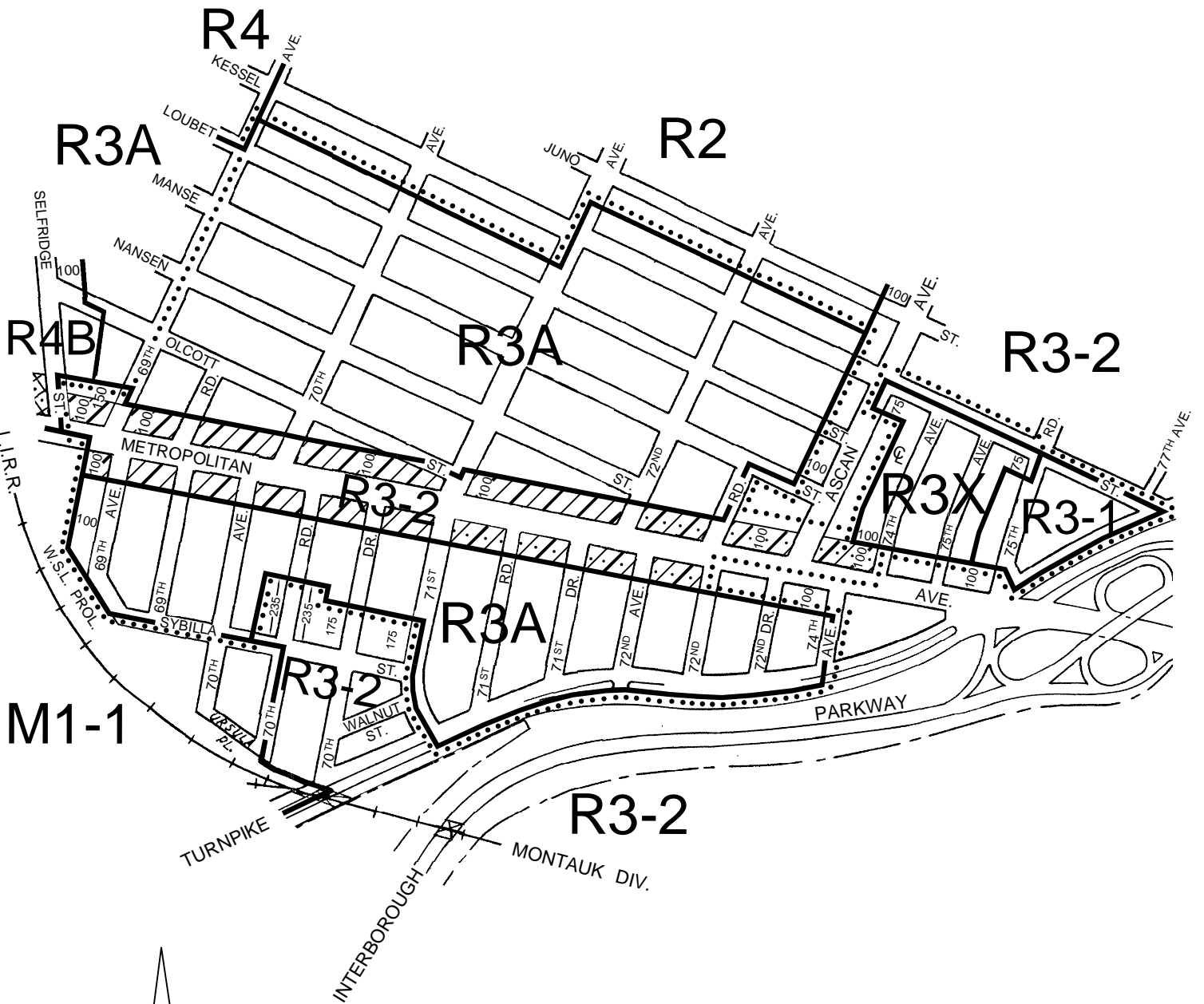



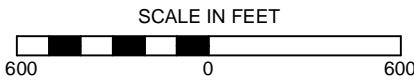

CITY PLANNING COMMISSION  
 CITY OF NEW YORK  
 DIAGRAM SHOWING  
**ZONING CHANGE**  
 ON SECTIONAL MAP  
**14b**  
 BOROUGH OF  
**QUEENS**

EFFECTIVE DATE  
**October 29, 2007**  
 C. C. RESO. # 1138



NOTE:

-  Indicates Zoning District Boundary.
-  The areas enclosed by the dotted lines are rezoned by eliminating C1-1 and C2-2 Districts from within an existing R3-2 District, by changing an R3-2 District to R3-1, R3A and R3X Districts, and by establishing C1-3 and C2-3 Districts within an existing R3-2 District.
-  Indicates a C1-3 District.
-  Indicates a C2-2 District.
-  Indicates a C2-3 District.

THIS DIAGRAM IS FOR ILLUSTRATIVE PURPOSES ONLY.



871  
861



CITY PLANNING COMMISSION  
 CITY OF NEW YORK  
 DIAGRAM SHOWING  
**ZONING CHANGE**  
 ON SECTIONAL MAPS  
**14d, 15b, 18c & 19a**  
 BOROUGH OF  
**QUEENS**

EFFECTIVE DATE  
**October 29, 2007**  
 C. C. RESO. # 1145

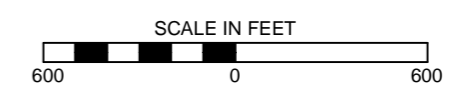

- NOTE:**
- Indicates Zoning District Boundary.
  - ..... The areas enclosed by the dotted lines are rezoned by eliminating C1-2, C1-3 and C2-2 Districts from existing R2, R3-2, R4, R5B and R6B Districts, and by changing R2, R3-2, R4 and R6B Districts to R2, R3A, R3X, R3-2, R4A, R4B, R4-1, R5B and R5D Districts, and by establishing C1-3 and C2-3 Districts in existing R3-2 and R5B Districts, and C1-3 and C2-3 Districts in adopted R3A, R4B, R4-1, R5B, R5D and R6A
  - ▨ Indicates a C1-2 District.
  - ▧ Indicates a C1-3 District.
  - ▩ Indicates a C1-4 District.
  - Indicates a C2-2 District.
  - Indicates a C2-3 District.
  - (E) Indicates a City Environmental Quality Review Declaration, refer to C.E.Q.R. sheet.

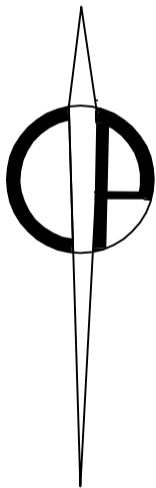
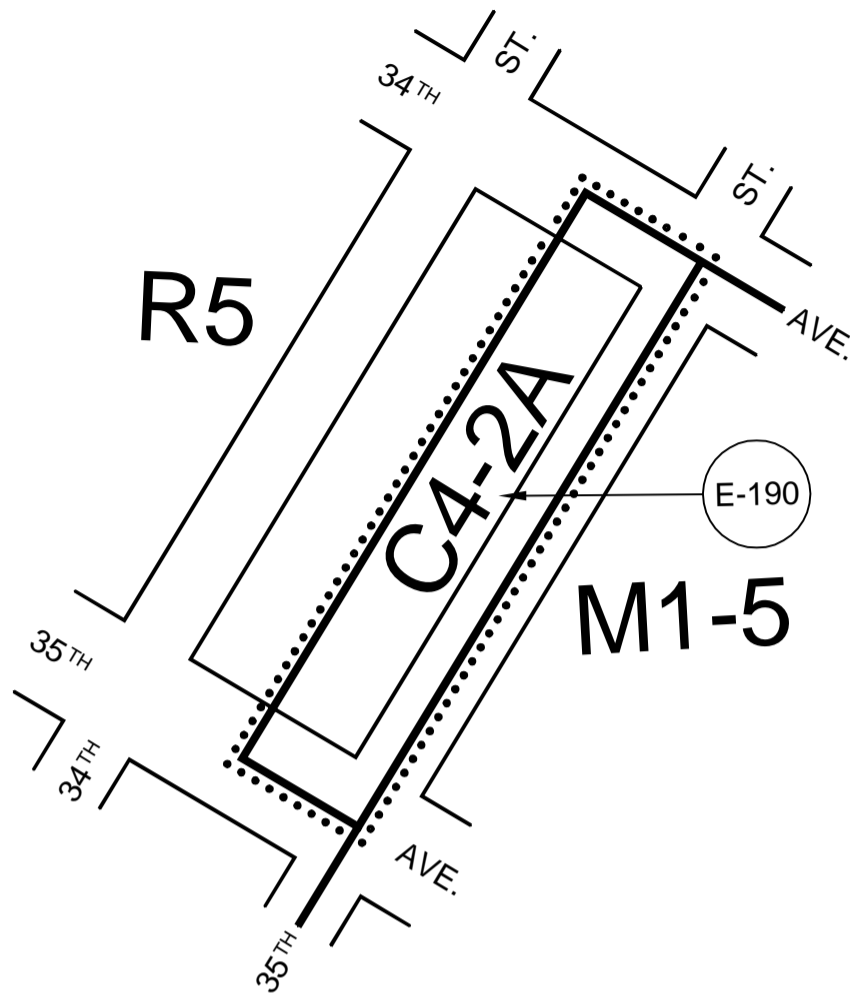

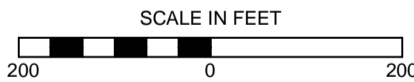

CITY PLANNING COMMISSION  
 CITY OF NEW YORK  
 DIAGRAM SHOWING PROPOSED  
**ZONING CHANGE**  
 ON SECTIONAL MAP  
**9b**  
 BOROUGH OF  
**QUEENS**

EFFECTIVE DATE  
**January 09, 2008**  
 C. C. RESO. # 1209



NOTE:

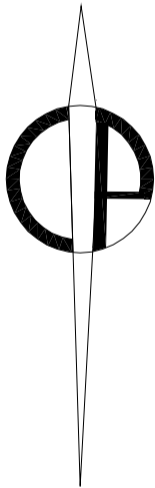
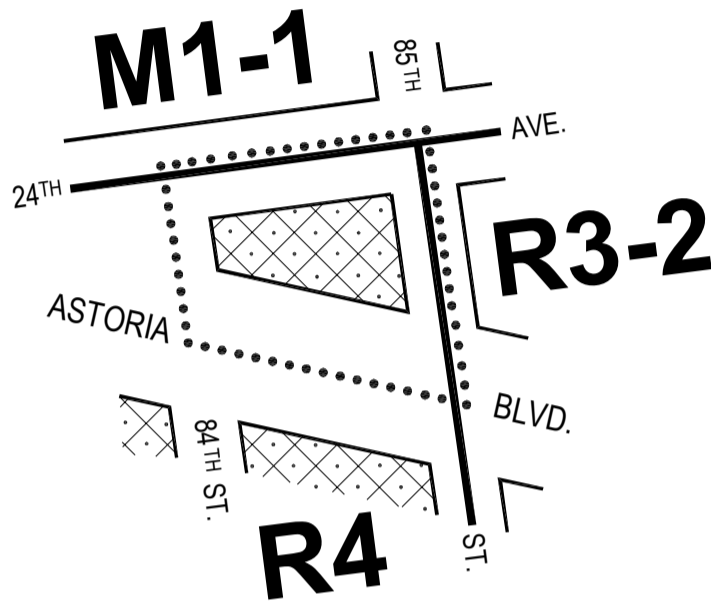

-  Indicates Zoning District Boundary.
-  The area enclosed by the dotted line is proposed to be rezoned by changing from an M1-5 District to a C4-2A District.
-  Indicates a City Environmental Quality Review Declaration, refer to C.E.Q.R. sheet.



CITY PLANNING COMMISSION  
 CITY OF NEW YORK  
 DIAGRAM SHOWING  
**ZONING CHANGE**  
 ON SECTIONAL MAP  
**9c**  
 BOROUGH OF  
**QUEENS**

EFFECTIVE DATE  
**January 28, 2008**  
 C. C. RESO. # 1793



- NOTE:
-  Indicates Zoning District Boundary.
  -  The area enclosed by the dotted line is rezoned by establishing a C2-2 District within an existing R4 District.
  -  Indicates a C2-2 District.

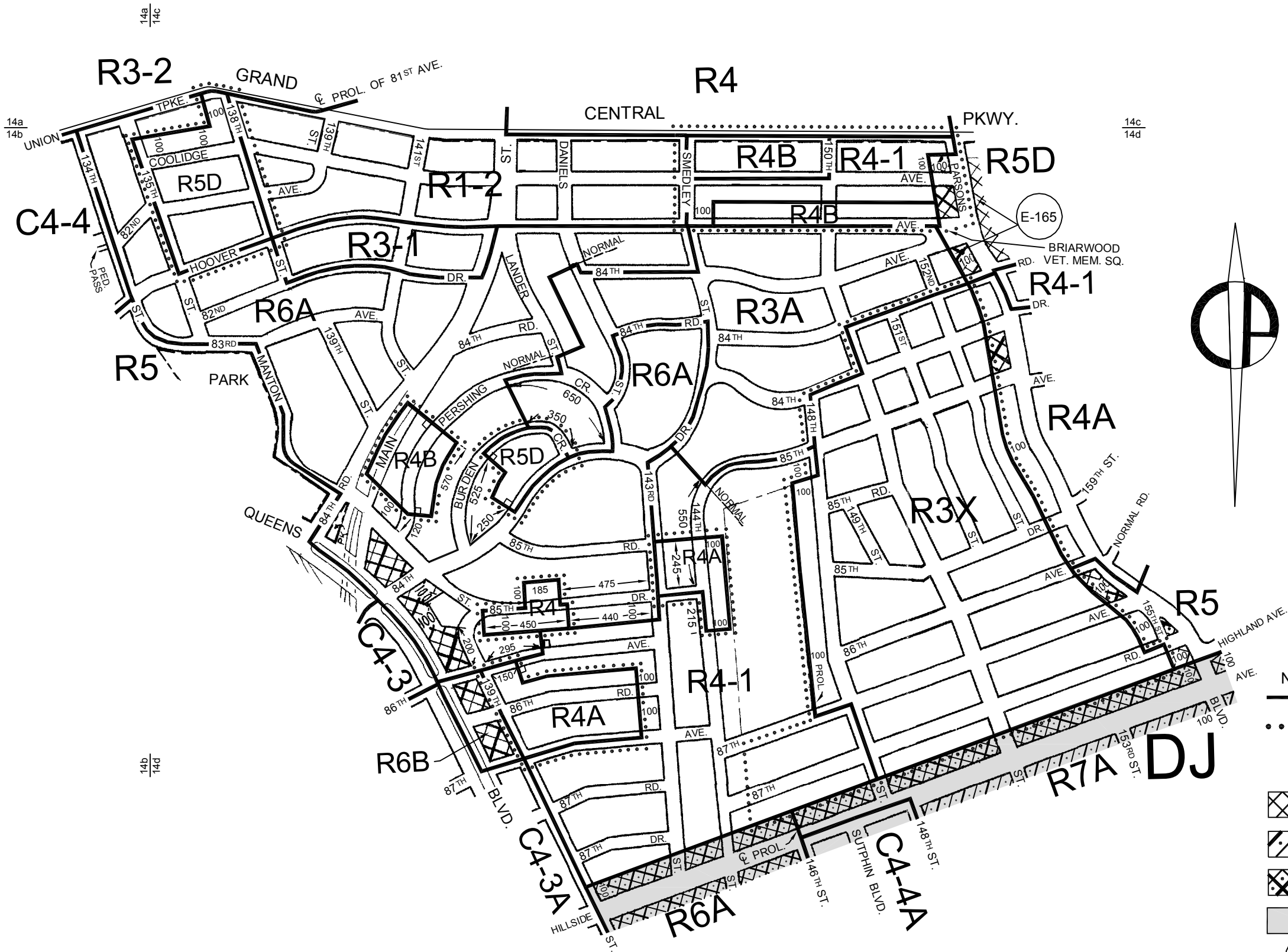

CITY PLANNING COMMISSION  
 CITY OF NEW YORK  
 DIAGRAM SHOWING  
**ZONING CHANGE**  
 ON SECTIONAL MAPS  
**14b, 14c & 14d**  
 BOROUGH OF  
**QUEENS**

EFFECTIVE DATE  
**February 27, 2008**  
 C. C. RESO. # 1295

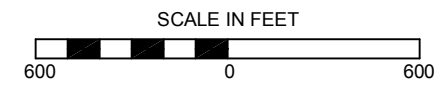

- NOTE:**
- Indicates Zoning District Boundary.
  - ..... The areas enclosed by the dotted lines are rezoned by changing R3A, R4, R4-1 and R6A Districts to R3X, R4, R4-1, R4A, R4B and R5D Districts.
  - ▧ Indicates a C1-2 District.
  - ▨ Indicates a C2-3 District.
  - ▩ Indicates a C2-4 District.
  - DJ** Indicates a Special Downtown Jamaica District.
  - (E)** Indicates a City Environmental Quality Review Declaration, refer to C.E.Q.R. sheet.



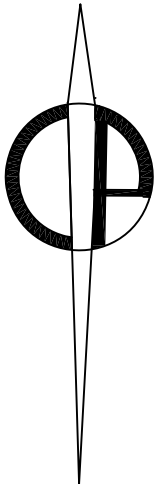
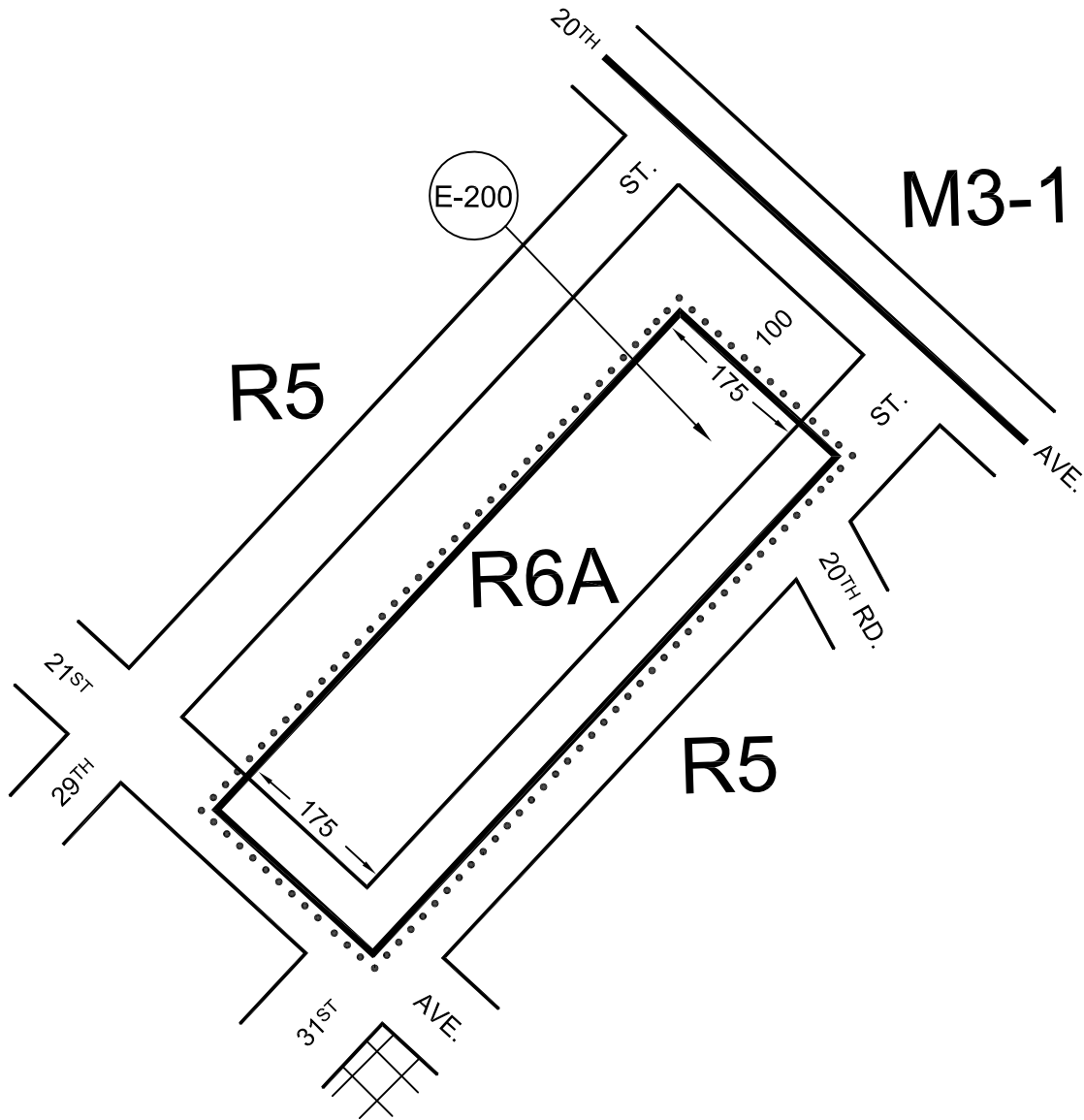

THIS DIAGRAM IS FOR ILLUSTRATIVE PURPOSES ONLY.

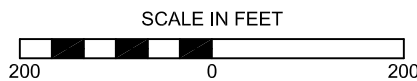

CITY PLANNING COMMISSION  
 CITY OF NEW YORK  
**ZONING CHANGE**  
 ON SECTIONAL MAP  
**9c**  
 BOROUGH OF  
**QUEENS**

EFFECTIVE DATE  
**March 26, 2008**  
 C. C. RESO. # 1334



- NOTE:
-  Indicates Zoning District Boundary.
  -  The area enclosed by the dotted line is proposed to be rezoned by changing from an R5 District to an R6A District.
  -  Indicates a C1-2 District.
  -  Indicates a City Environmental Quality Review Declaration, refer to C.E.Q.R. sheet.

THIS DIAGRAM IS FOR ILLUSTRATIVE PURPOSES ONLY.

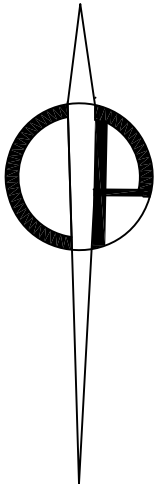
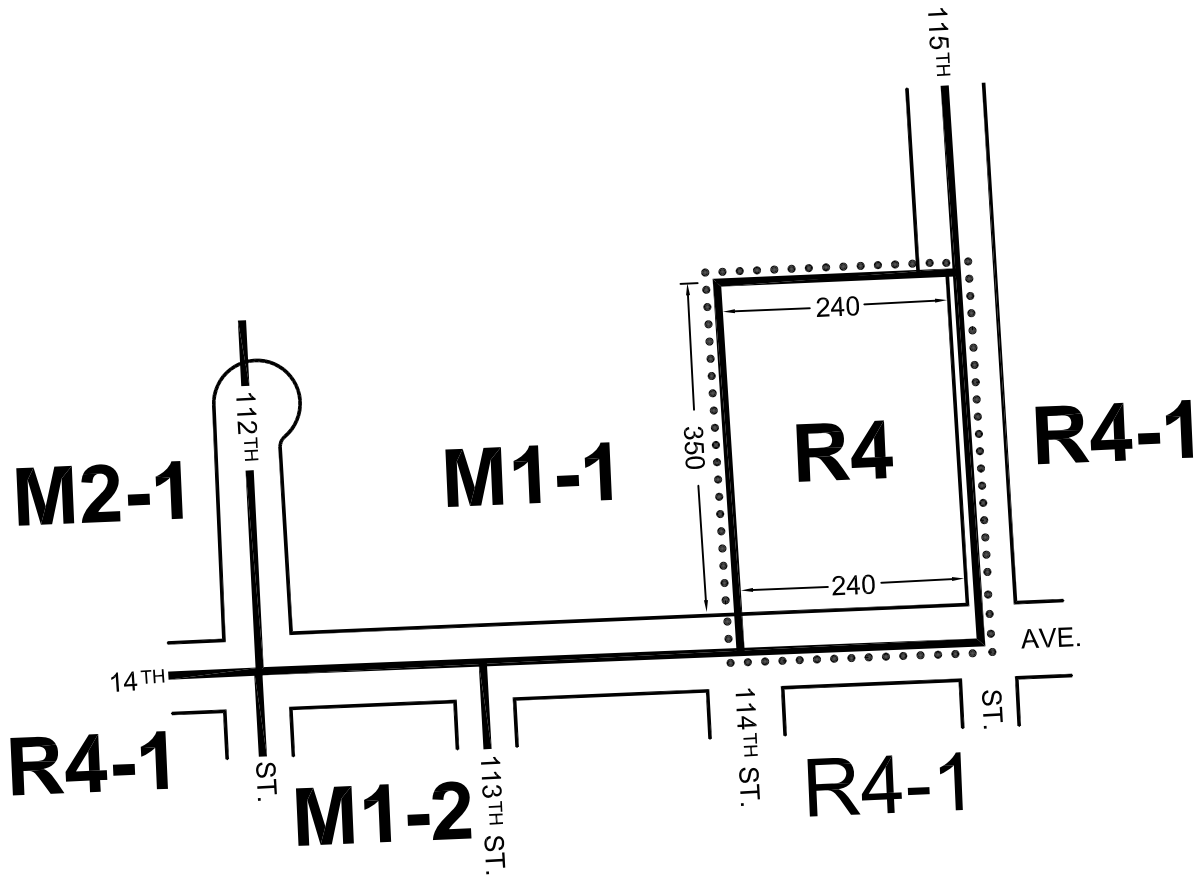

CITY PLANNING COMMISSION  
 CITY OF NEW YORK  
 DIAGRAM SHOWING  
**ZONING CHANGE**  
 ON SECTIONAL MAP  
**7b**  
 BOROUGH OF  
**QUEENS**

EFFECTIVE DATE  
**July 1, 2008**  
 C. C. RESO. # 1408

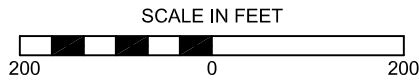

- NOTE:
- Indicates Zoning District Boundary.
  - .....** The area enclosed by the dotted line is rezoned by changing from an M1-1 District to an R4 District.



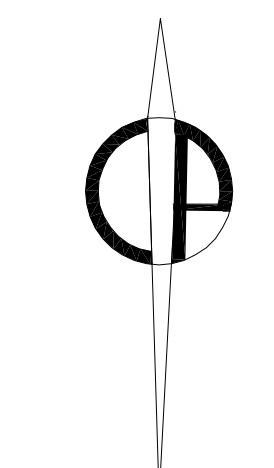


CITY PLANNING COMMISSION  
 CITY OF NEW YORK  
 DIAGRAM SHOWING  
**ZONING CHANGE**  
 ON SECTIONAL MAPS  
**25b, 30a, 30b 30c, 30d & 31a**  
 BOROUGH OF  
**QUEENS**

EFFECTIVE DATE  
 August 14, 2008  
 C. C. RESO. # 1587

- NOTE:
- Indicates Zoning District Boundary.
  - ..... The area enclosed by the dotted line is rezoned by eliminating C1-2, C2-2 and C2-4 Districts from within existing R3-2, R4, R5 and R6 Districts, by changing R2, R3A, R3-1, R3-2, R4, R4-1, R4A, R5, R6 and C3 Districts to R2X, R3A, R3X, R4, R4-1, R4A, R4B, R5, R5A, R5B, R5D, R6A, R7A, C4-3A, C4-4 and M1-1 Districts, and by establishing within adopted R3A, R4-1, R4A, R5A, R5B, R5D and R7A Districts C1-2 and C2-3 Districts.
  - ▨ Indicates a C1-2 District.
  - ▧ Indicates a C1-3 District.
  - ▩ Indicates a C2-2 District.
  - Indicates a C2-3 District.
  - Indicates a C2-4 District.
  - ⓔ Indicates a City Environmental Quality Review Declaration, refer to C.E.Q.R. sheet.



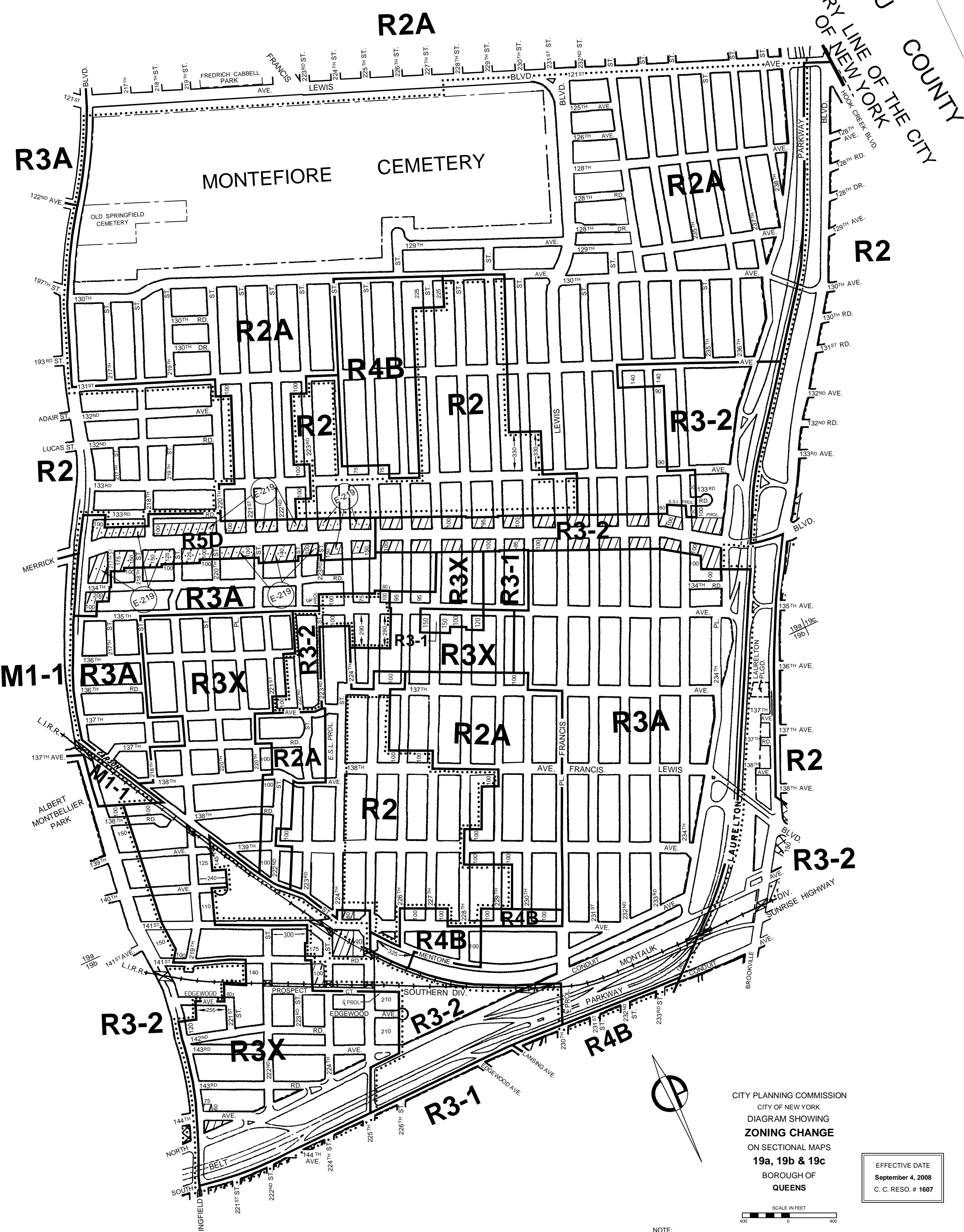

CITY PLANNING COMMISSION  
 CITY OF NEW YORK  
 DIAGRAM SHOWING  
 ZONING CHANGE  
 ON SECTIONAL MAPS  
 19a, 19b & 19c  
 BOROUGH OF  
 QUEENS

EFFECTIVE DATE  
 September 4, 2008  
 C. C. RESO. # 1607

SCALE IN FEET  
 0 200 400



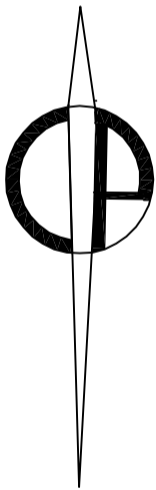
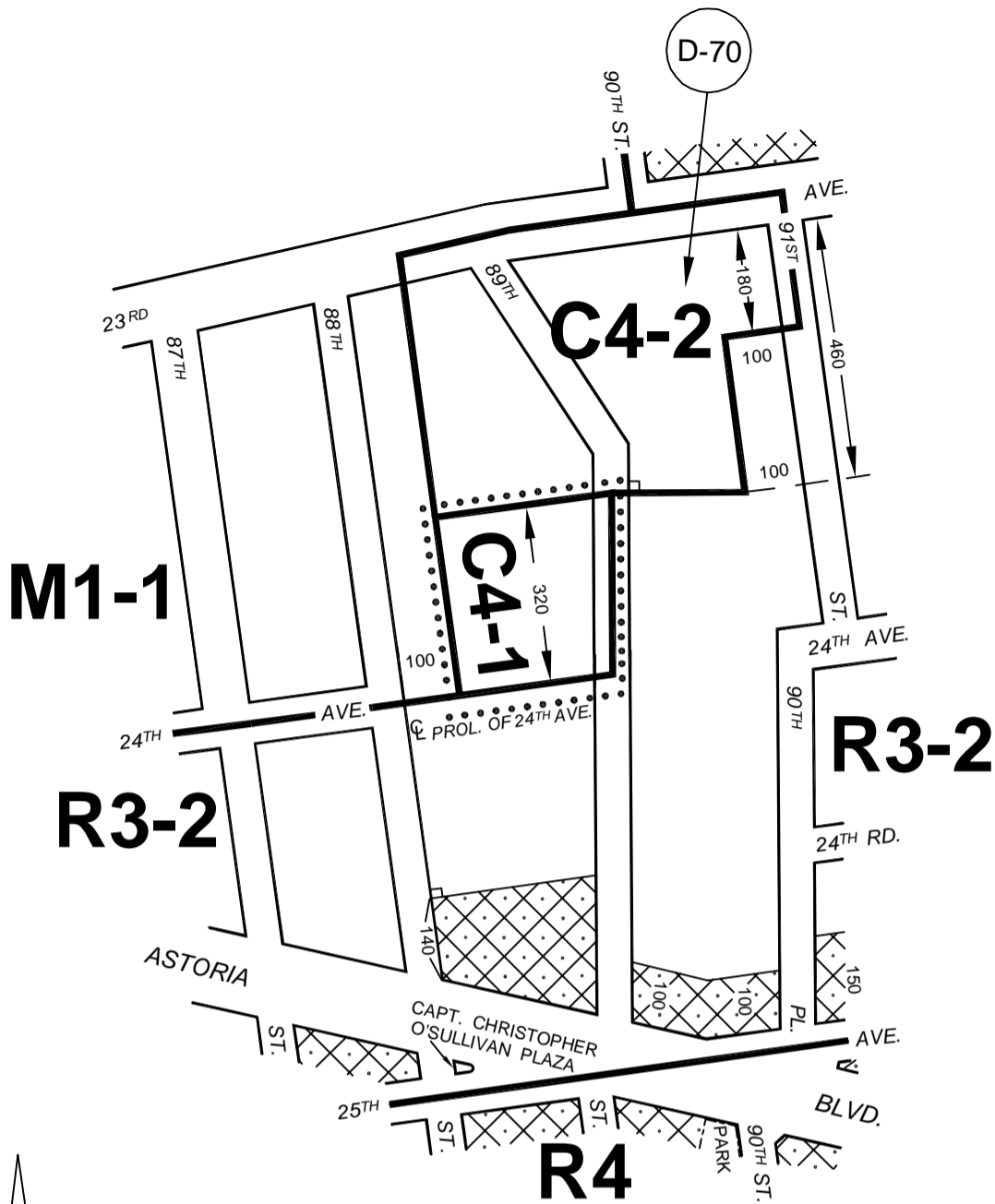

- NOTE:
- Indicates Zoning District Boundary.
  - ..... The area enclosed by the dotted line is rezoned by eliminating C1-2 and C2-2 Districts from within an existing R3-2 District, by changing R2, R3-2 and C8-1 Districts to R2, R2A, R3A, R3X, R3-1, R3-2, R4B and R5D Districts, and by establishing within adopted R3X, R3-2 and R5D Districts C1-3 and C2-3 Districts.
  - [Hatched Pattern] Indicates a C1-3 District.
  - [Hatched Pattern] Indicates a C2-3 District.
  - (E) Indicates a City Environmental Quality Review Declaration, refer to C.E.Q.R. sheet.

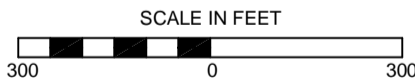

CITY PLANNING COMMISSION  
 CITY OF NEW YORK  
 DIAGRAM SHOWING  
**ZONING CHANGE**  
 ON SECTIONAL MAP  
**9c**  
 BOROUGH OF  
**QUEENS**

EFFECTIVE DATE  
**September 24, 2008**  
 C. C. RESO. # 1636



- NOTE:
-  Indicates Zoning District Boundary.
  -  The area enclosed by the dotted line is rezoned by changing from R3-2 and C4-2 Districts to a C4-1 District.
  -  Indicates a C2-2 District.
  -  Indicates a Restrictive Declaration Area, refer to R.D. sheet.

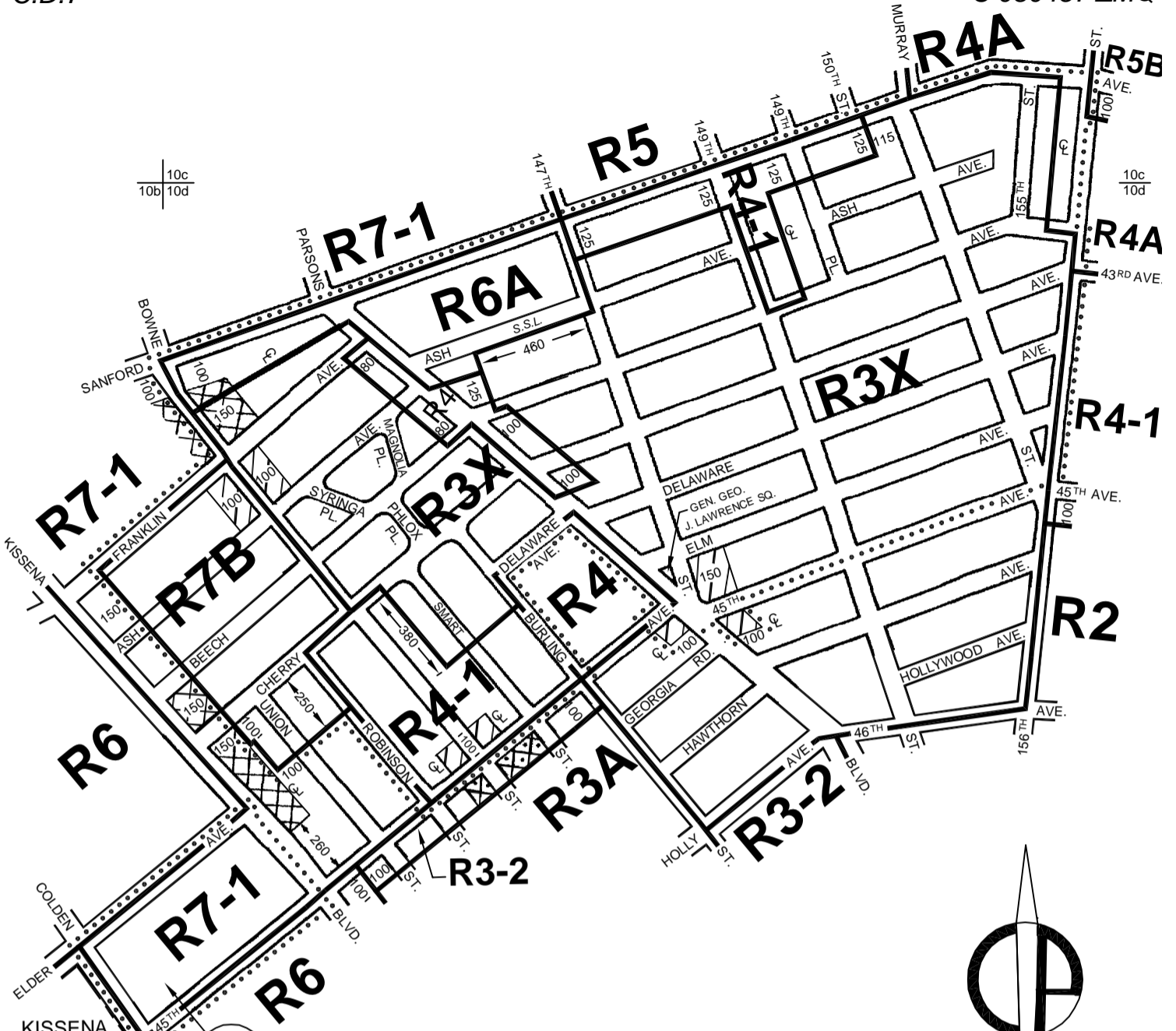

10c  
10b 10d

10c  
10d

10b  
10d



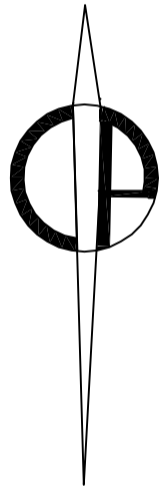

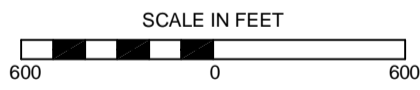

CITY PLANNING COMMISSION  
 CITY OF NEW YORK  
 DIAGRAM SHOWING  
**ZONING CHANGE**  
 ON SECTIONAL MAPS  
**10b, 10c & 10d**  
 BOROUGH OF  
**QUEENS**



EFFECTIVE DATE  
**September 24, 2008**  
 C. C. RESO. # 1637



**NOTE:**



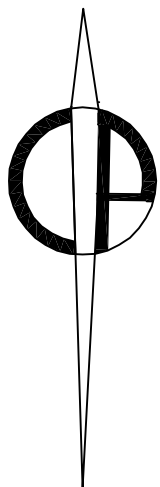
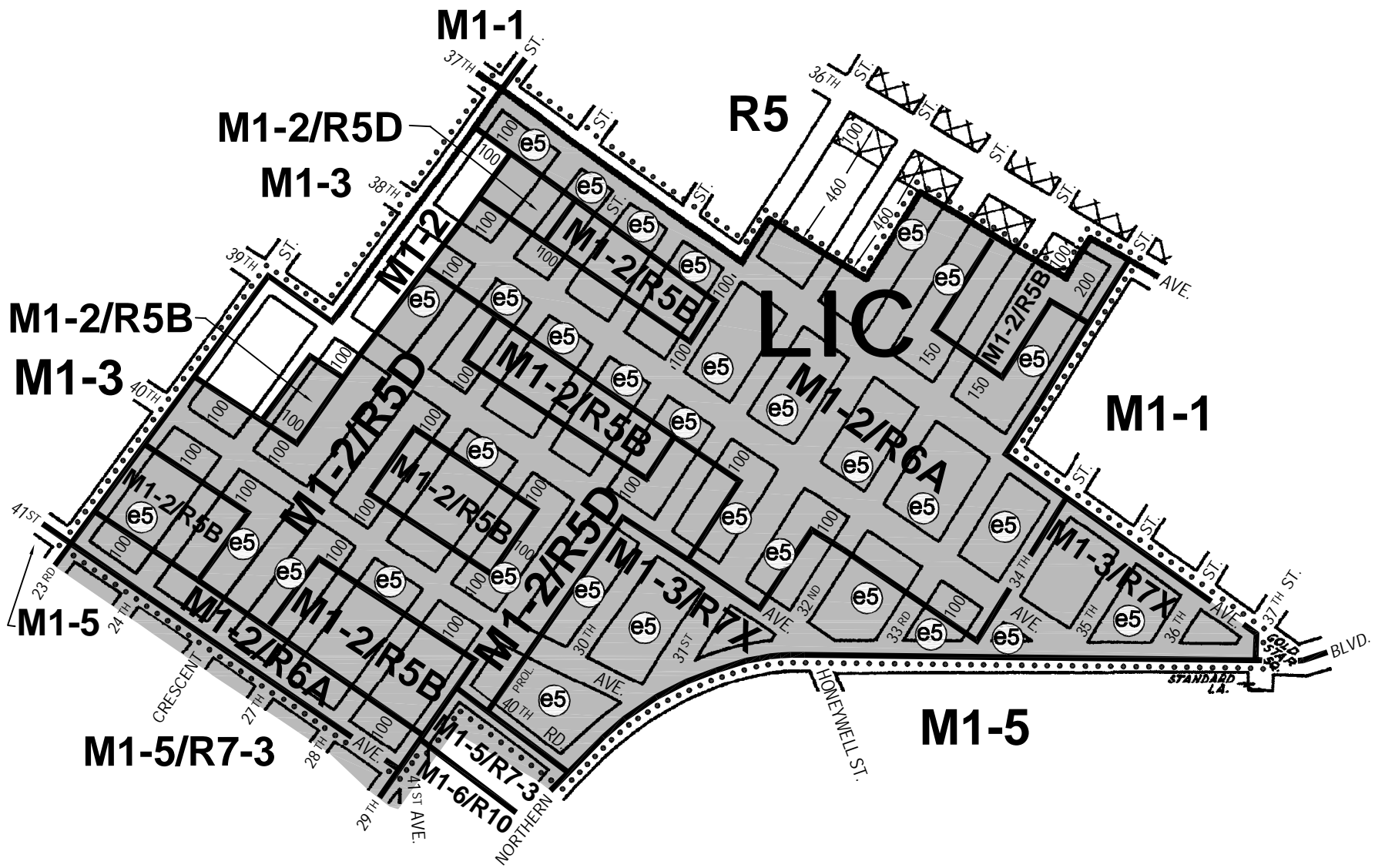

-  Indicates Zoning District Boundary.
-  The areas enclosed by the dotted lines are rezoned by eliminating C1-2 and C2-2 Districts from within existing R3-2 and R7-1 Districts, by changing R3-2, R6 and R7-1 Districts to R3X, R4, R4A, R4-1, R6A, R7-1 and R7B Districts, and by establishing C1-3 within adopted R3X, R4-1 and R7B Districts.
-  Indicates a C1-2 District.
-  Indicates a C1-3 District.
-  Indicates a C2-2 District.
-  Indicates a City Environmental Quality Review Declaration, refer to C.E.Q.R. sheet.

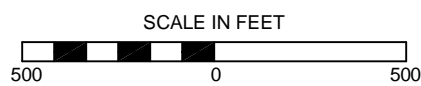

CITY PLANNING COMMISSION  
 CITY OF NEW YORK  
 DIAGRAM SHOWING  
**ZONING CHANGE**  
 ON SECTIONAL MAP  
**9b**  
 BOROUGH OF  
**QUEENS**

EFFECTIVE DATE  
**October 7, 2008**  
 C. C. RESO. # 1658





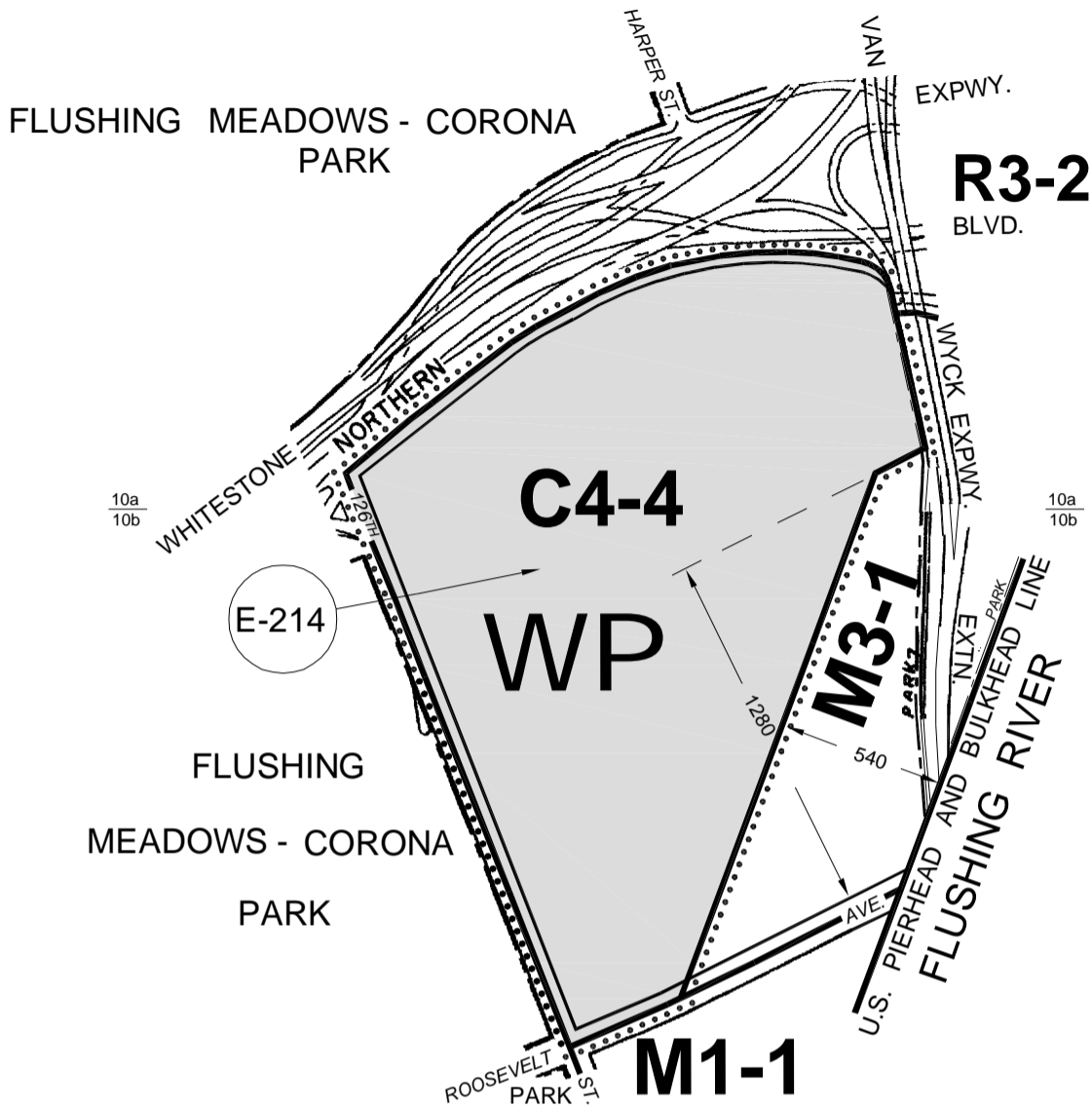

- NOTE:**
-  Indicates Zoning District Boundary.
  -  The area enclosed by the dotted line is rezoned by changing M1-1 and M1-3D Districts to M1-2, M1-2/R5B, M1-2/R5D, M1-2/R6A and M1-3/R7X Districts and by establishing a Special Long Island City District (LIC).
  -  Indicates a C1-2 District.
  -  Indicates a Special Long Island City District.
  -  Indicates a City Environmental Quality Review Declaration E-218, refer to C.E.Q.R. sheet.



CITY PLANNING COMMISSION  
 CITY OF NEW YORK  
 DIAGRAM SHOWING  
**ZONING CHANGE**  
 ON SECTIONAL MAP  
**10a & 10b**  
 BOROUGH OF  
**QUEENS**

EFFECTIVE DATE  
**November 13, 2008**  
 C. C. RESO. # 1688



- NOTE:**
-  Indicates Zoning District Boundary.
  -  The area enclosed by the dotted line is rezoned by changing R3-2 and M3-1 Districts to a C4-4 District, and by establishing a Special Willets Point District (WP).
  -  Indicates a Special Willets Point District.
  -  Indicates a City Environmental Quality Review Declaration, refer to C.E.Q.R. sheet.

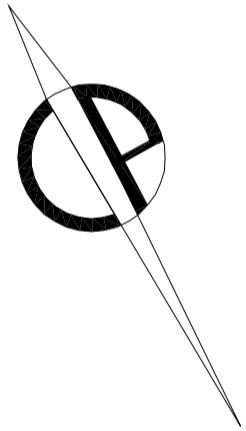
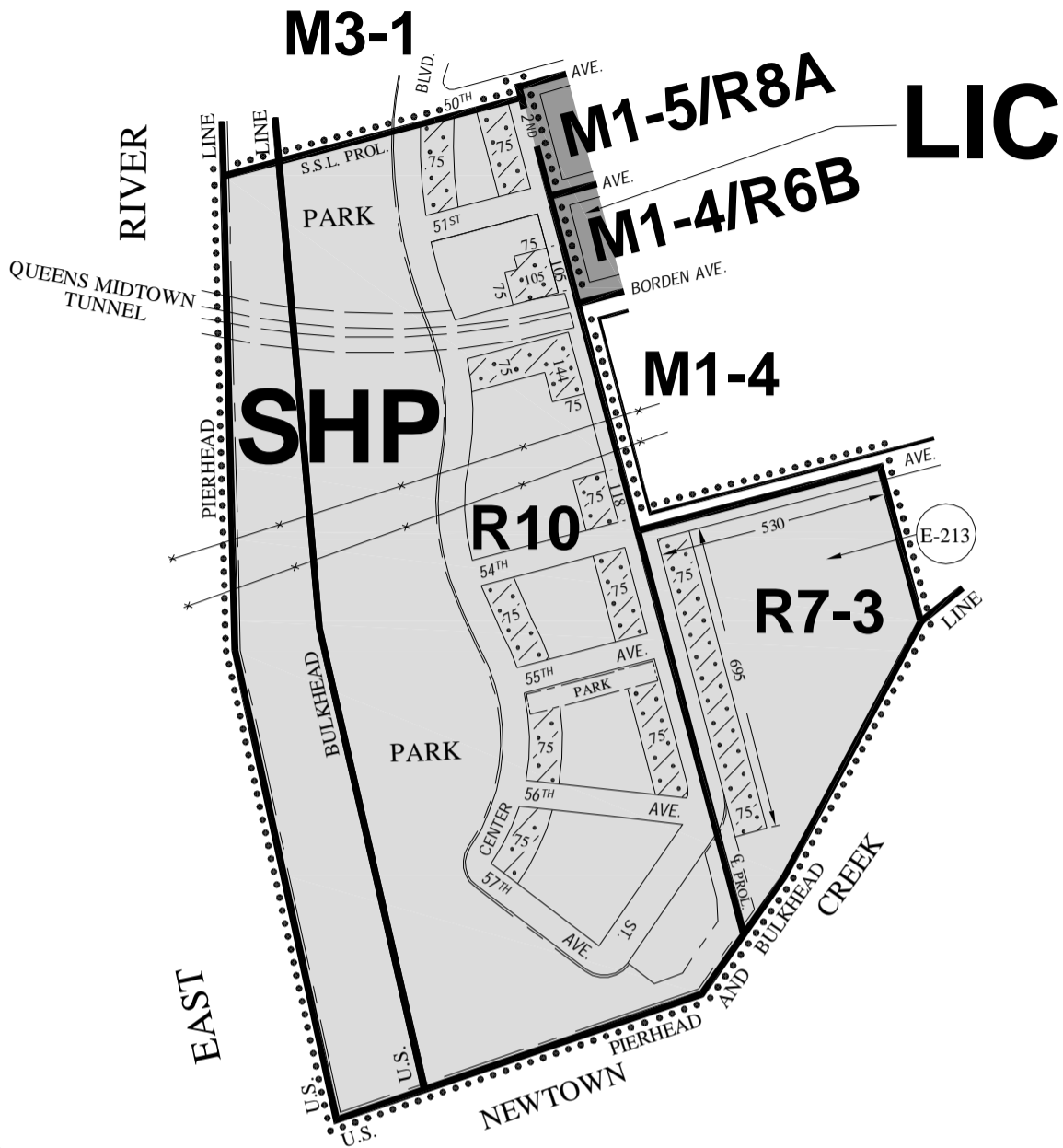







CITY PLANNING COMMISSION  
 CITY OF NEW YORK  
 DIAGRAM SHOWING  
**ZONING CHANGE**  
 ON SECTIONAL MAP  
**8d**

BOROUGH OF  
**QUEENS**

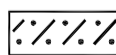
EFFECTIVE DATE  
**November 13, 2008**  
 C. C. RESO. # 1697



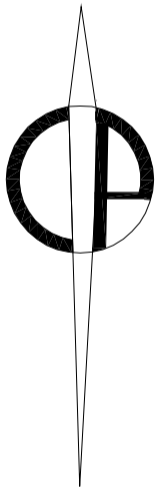
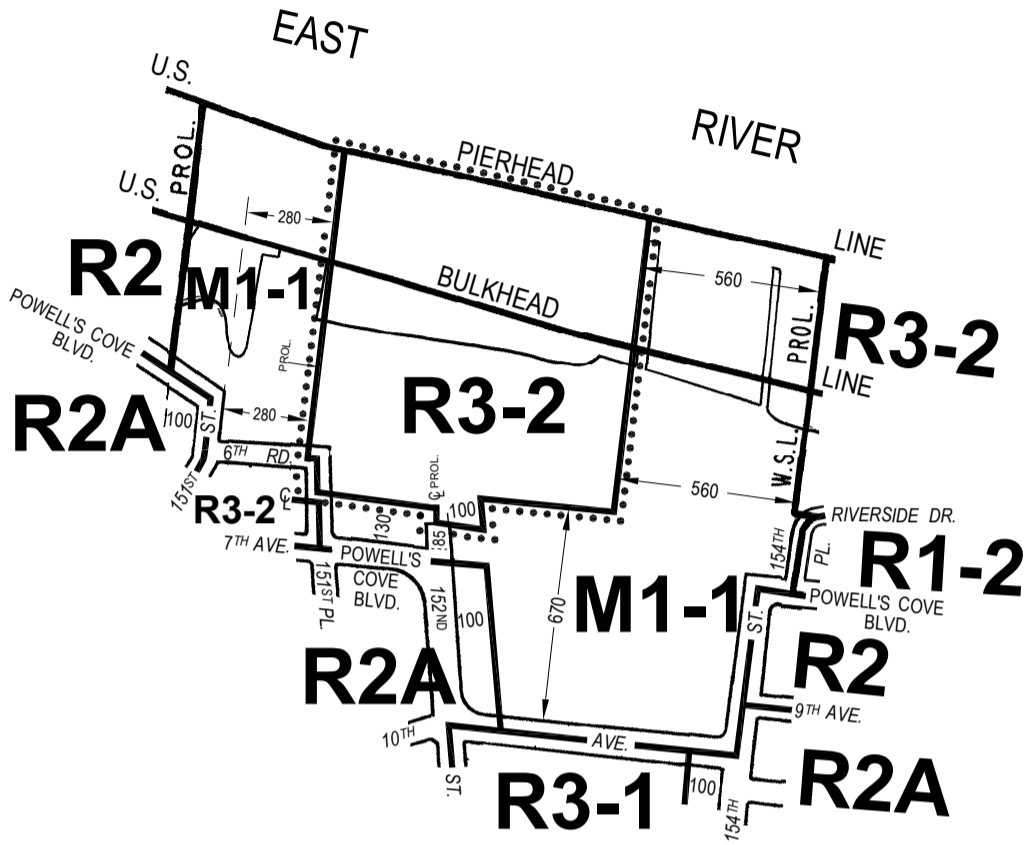

- NOTE:**
-  Indicates Zoning District Boundary.
  -  The area enclosed by the dotted line is rezoned by changing M1-4 and M3-1 Districts to R7-3 and R10 Districts, and establishing a C2-5 District within adopted R7-3 and R10 Districts, and establishing a Special Southern Hunters Point District (SHP).
  -  Indicates a C2-5 District.
  -  Indicates a Special Long Island City District.
  -  Indicates a Special Southern Hunters Point District.
  -  Indicates a City Environmental Quality Review Declaration, refer to C.E.Q.R. sheet.



**ZONING CHANGE**  
 ON SECTIONAL MAP  
**7d**  
 BOROUGH OF  
**QUEENS**

EFFECTIVE DATE  
**December 9, 2008**  
 C. C. RESO. # 1731



- NOTE:**
-  Indicates Zoning District Boundary.
  -  The area enclosed by the dotted line is rezoned by changing from an M1-1 District to an R3-2 District.



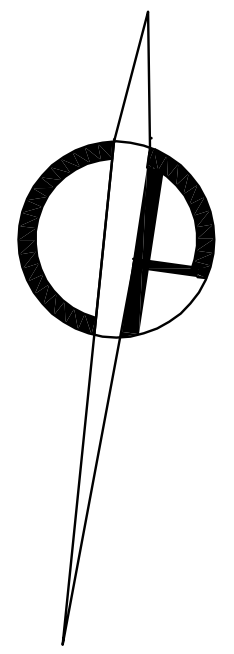
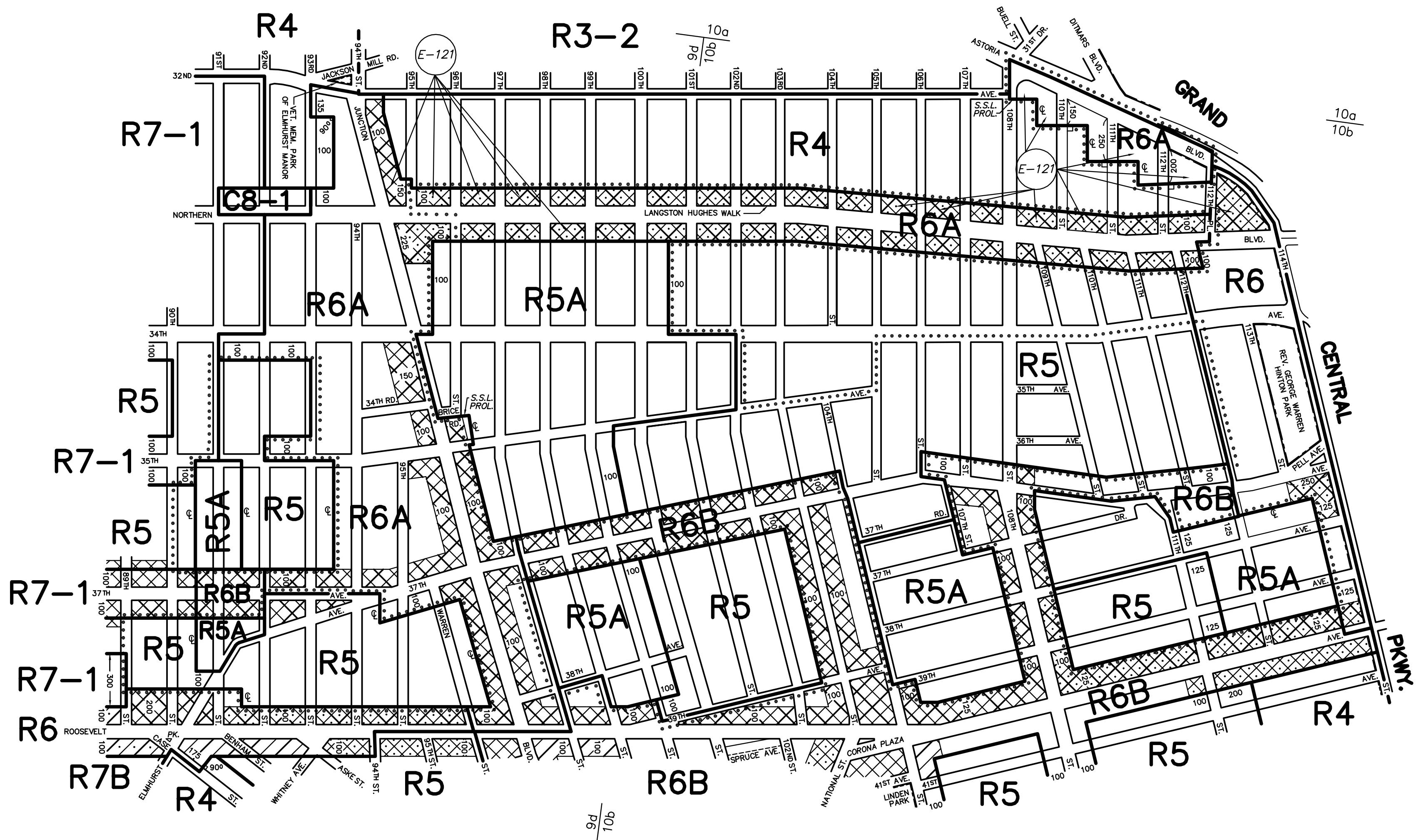







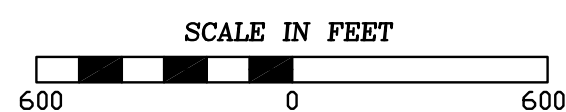

CITY PLANNING COMMISSION  
CITY OF NEW YORK

DIAGRAM SHOWING  
**ZONING CHANGE**  
ON SECTIONAL MAPS  
**9d, 10a & 10b**  
BOROUGH OF  
**QUEENS**

EFFECTIVE DATE  
March 24, 2009  
C. C. RESO. # 1883

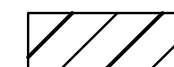
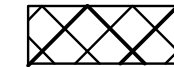
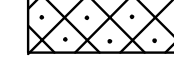

**NOTE:**

-  Indicates Zoning District boundary.
-  The areas enclosed by the dotted lines are rezoned by changing R5, R6 and R6B Districts to R5, R5A and R6A Districts.
-  Indicates a C1-2 District.
-  Indicates a C1-3 District.
-  Indicates a C1-4 District.
-  Indicates a C2-2 District.
-  Indicates a C2-3 District.
-  Indicates a C2-4 District.
-  Indicates a City Environmental Quality Review Declaration, refer to C.E.Q.R. sheet.

THIS DIAGRAM IS FOR ILLUSTRATIVE PURPOSES ONLY.

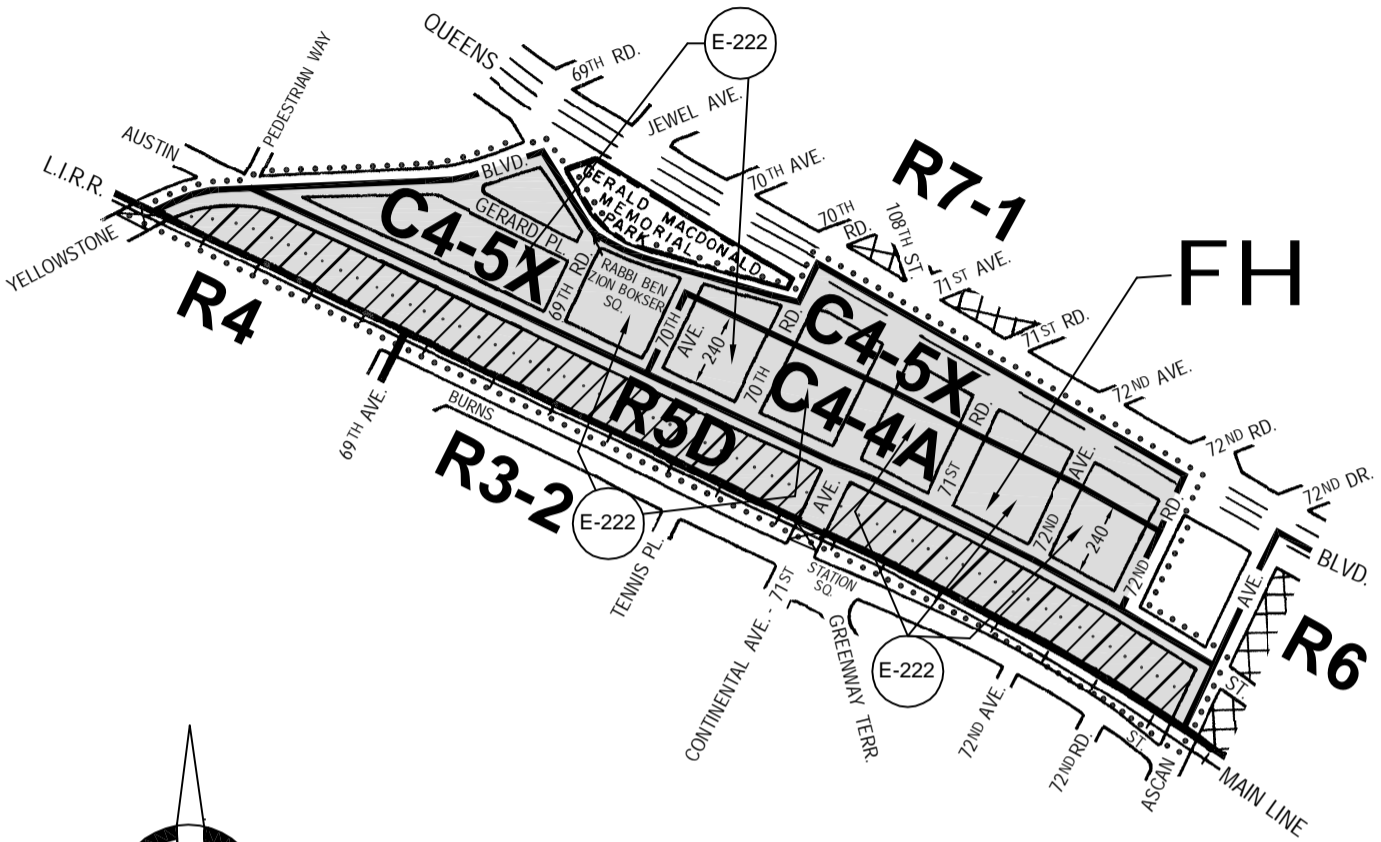





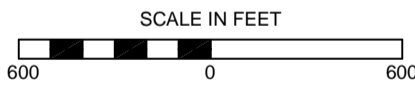

CITY PLANNING COMMISSION  
 CITY OF NEW YORK  
 DIAGRAM SHOWING  
**ZONING CHANGE**  
 ON SECTIONAL MAP  
**14a**  
 BOROUGH OF  
**QUEENS**

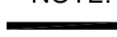
EFFECTIVE DATE  
**March 24, 2009**  
 C. C. RESO. # 1888



NOTE:

-  Indicates Zoning District Boundary.
-  The area enclosed by the dotted line is rezoned by eliminating a C1-2 District from within an existing R7-1 District, by changing R7-1, C4-2 and C8-2 Districts to R5D, C4-4A and C4-5X Districts, by establishing a C2-3 District within an adopted R5D District, and by establishing a Special Forest Hills District (FH).
-  Indicates a C1-2 District.
-  Indicates a C2-3 District.
-  Indicates a Special Forest Hills District.
-  Indicates a City Environmental Quality Review Declaration, refer to C.E.Q.R. sheet.

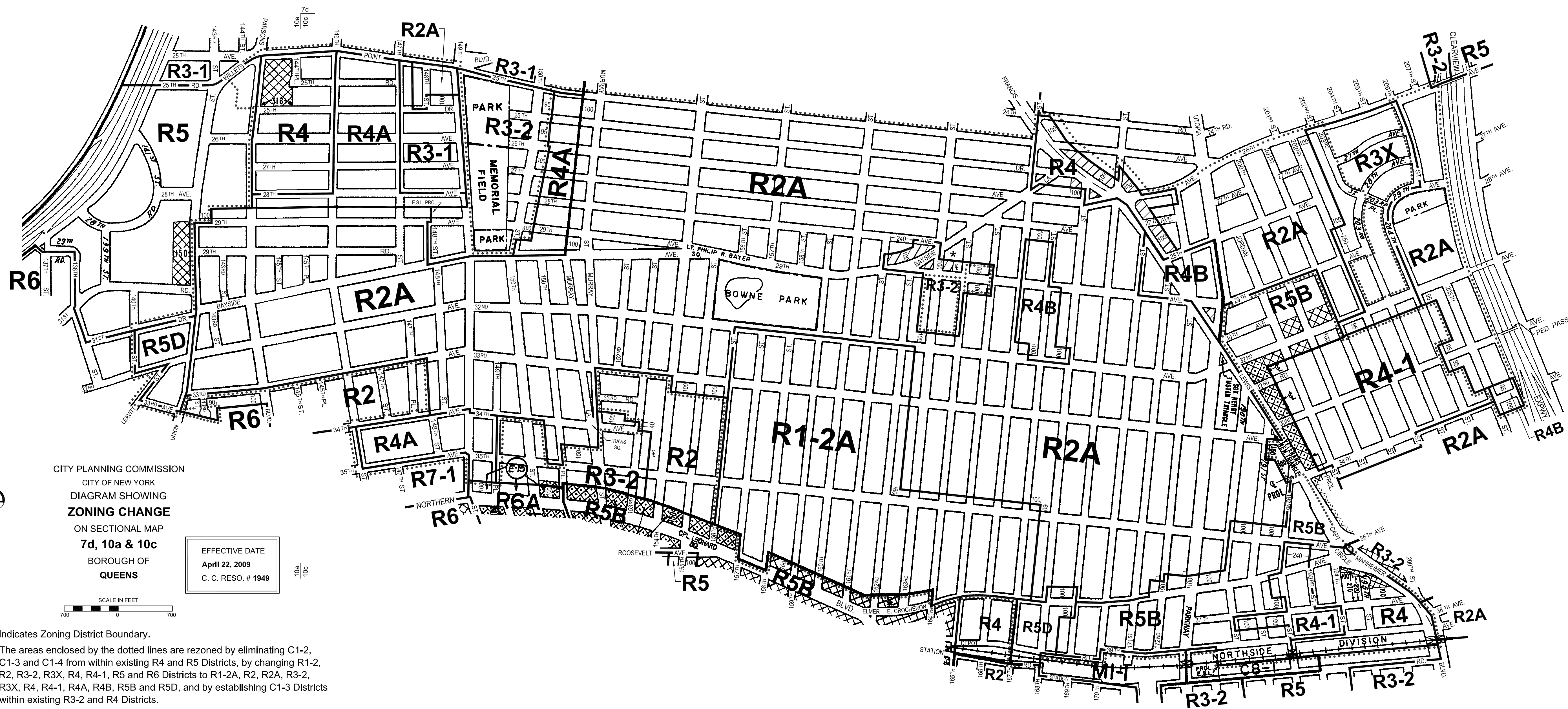
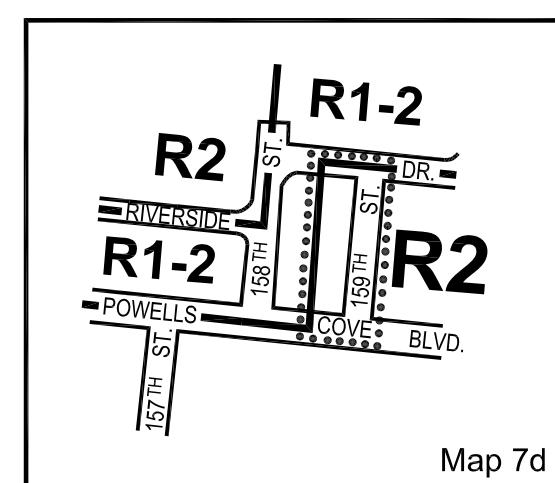

CITY PLANNING COMMISSION  
 CITY OF NEW YORK  
 DIAGRAM SHOWING  
**ZONING CHANGE**  
 ON SECTIONAL MAP  
**7d, 10a & 10c**  
 BOROUGH OF  
**QUEENS**

EFFECTIVE DATE  
**April 22, 2009**  
 C. C. RESO. # 1949

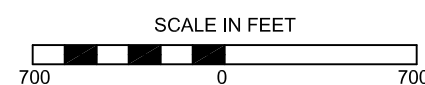

- NOTE:
- ..... Indicates Zoning District Boundary.
  - ..... The areas enclosed by the dotted lines are rezoned by eliminating C1-2, C1-3 and C1-4 from within existing R4 and R5 Districts, by changing R1-2, R2, R3-2, R3X, R4, R4-1, R5 and R6 Districts to R1-2A, R2, R2A, R3-2, R3X, R4, R4-1, R4A, R4B, R5B and R5D, and by establishing C1-3 Districts within existing R3-2 and R4 Districts.
  - ▨ Indicates a C1-2 District.
  - ▧ Indicates a C1-3 District.
  - ▩ Indicates a C2-2 District.
  - (E) Indicates a City Environmental Quality Review Declaration, refer to C.E.Q.R. sheet.

\* As Corrected 6/12/09

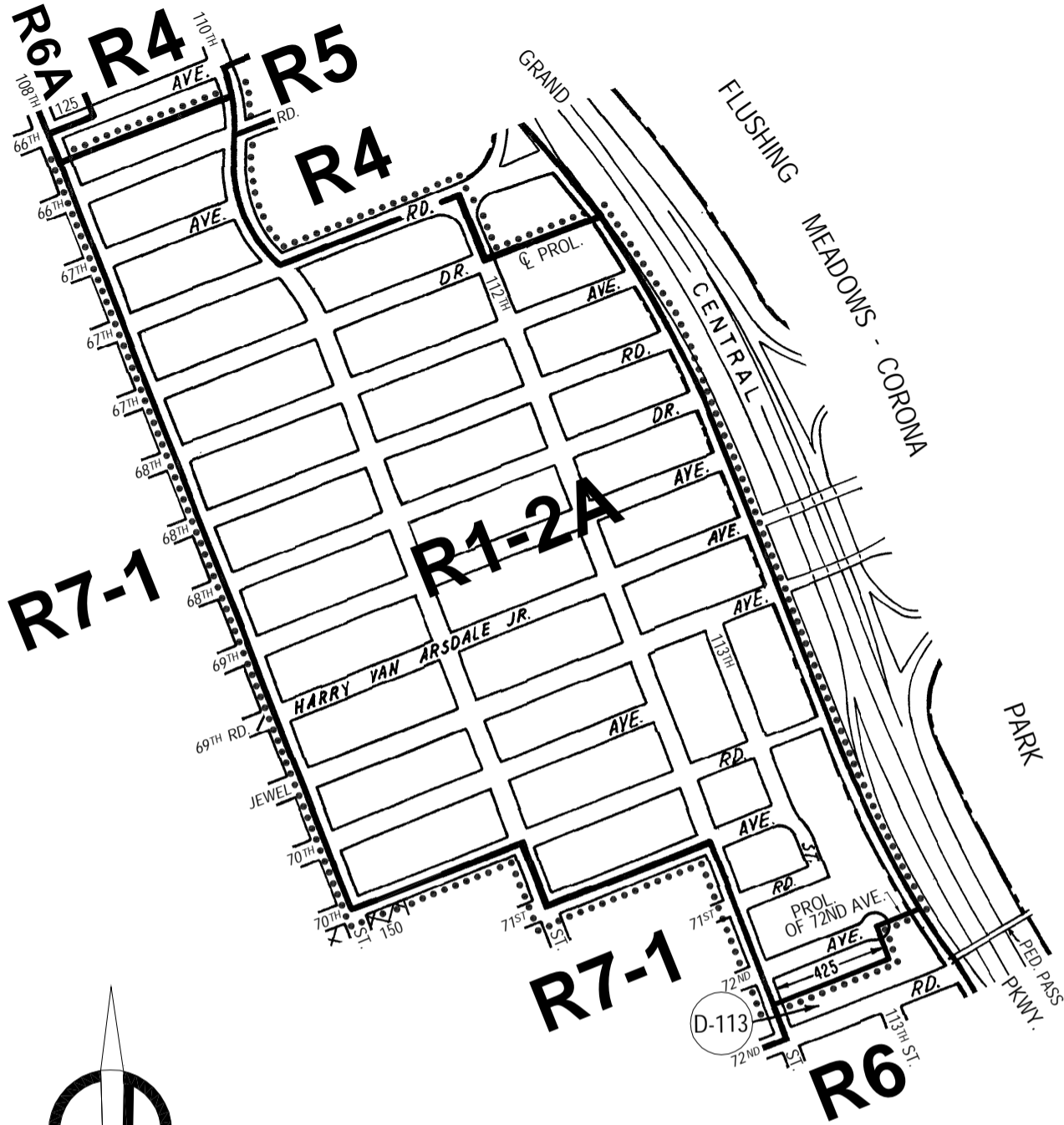





CITY PLANNING COMMISSION  
 CITY OF NEW YORK  
 DIAGRAM SHOWING  
**ZONING CHANGE**  
 ON SECTIONAL MAP  
 14a  
 BOROUGH OF  
**QUEENS**

EFFECTIVE DATE  
**June 30, 2009**  
 C. C. RESO. # 2065



NOTE:

-  Indicates Zoning District Boundary.
-  The area enclosed by the dotted line is rezoned by changing from an R1-2 District to an R1-2A District.
-  Indicates a C1-2 District.
-  Indicates a Restrictive Declaration Area, refer to R.D. sheet.



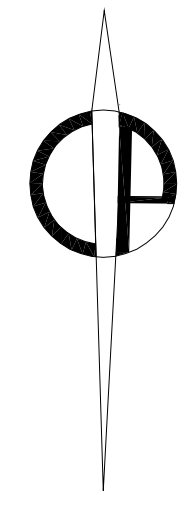
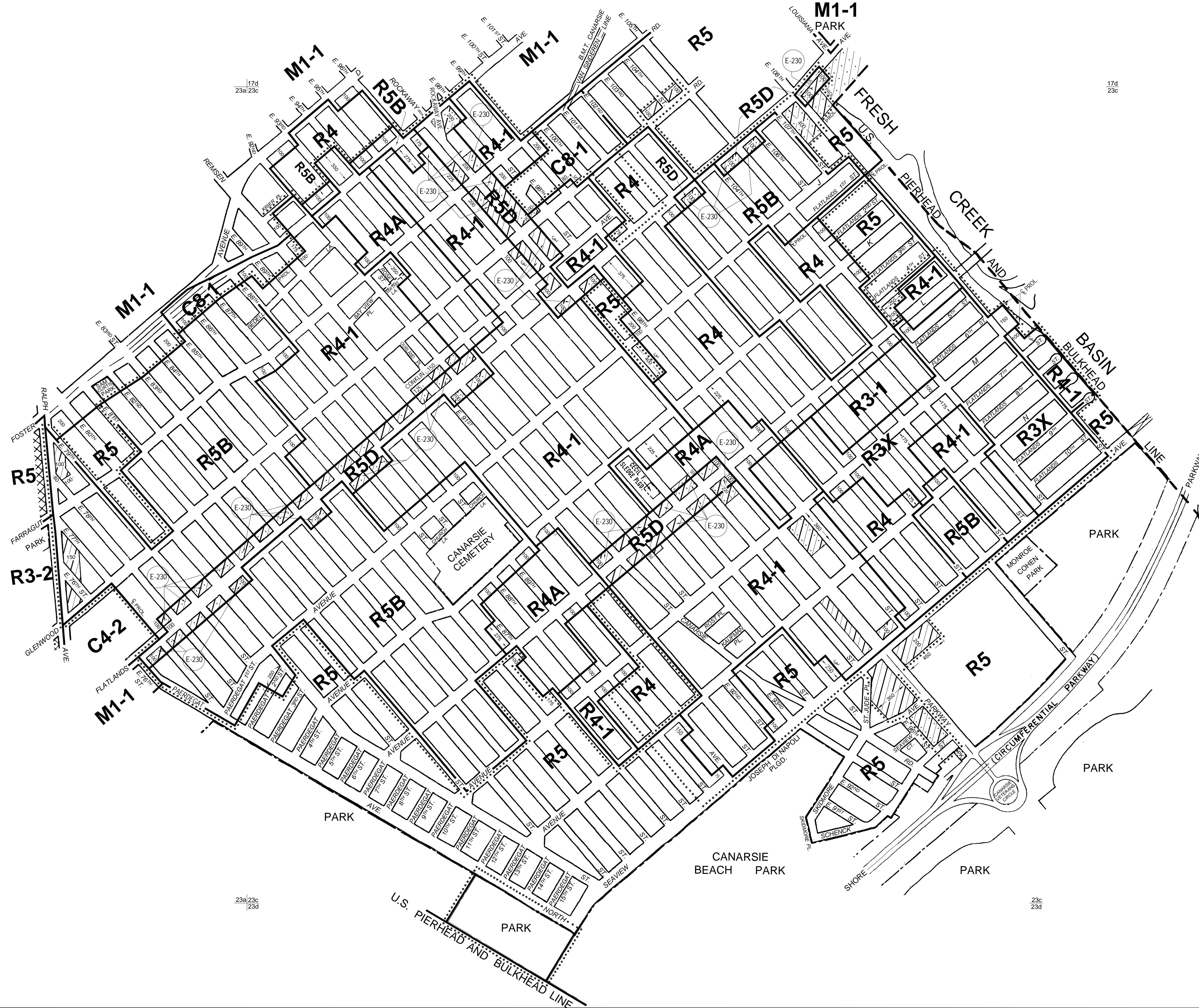

CITY PLANNING COMMISSION  
 CITY OF NEW YORK  
 DIAGRAM SHOWING  
**ZONING CHANGE**  
 ON SECTIONAL MAPS  
**17d, 23a, 23c & 23d**  
 BOROUGH OF  
**BROOKLYN**

EFFECTIVE DATE  
 June 30, 2009  
 C. C. RESO. # 2075

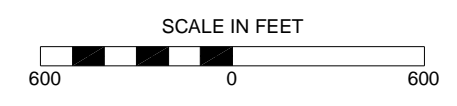

- NOTE:
- Indicates Zoning District Boundary.
  - ..... The area enclosed by the dotted line is rezoned by eliminating C1-2, C2-1 and C2-2 Districts from R4 and R5 Districts, by changing from R4, R5, C3 and C8-1 Districts to R3-1, R3X, R4-1, R4A, R5, R5B and R5D Districts, by establishing within an existing R5 District, C1-3 and C2-3 Districts, and by establishing within adopted R4-1, R5, R5B and R5D Districts, C1-3 and C2-3 Districts.
  - ▨ Indicates a C1-3 District.
  - ▧ Indicates a C2-1 District.
  - ▩ Indicates a C2-3 District.
  - (E) Indicates a City Environmental Quality Review Declaration, refer to C.E.Q.R. sheet.

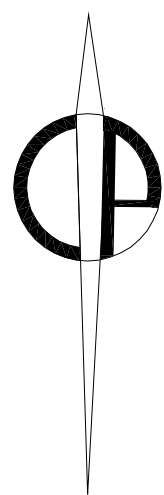
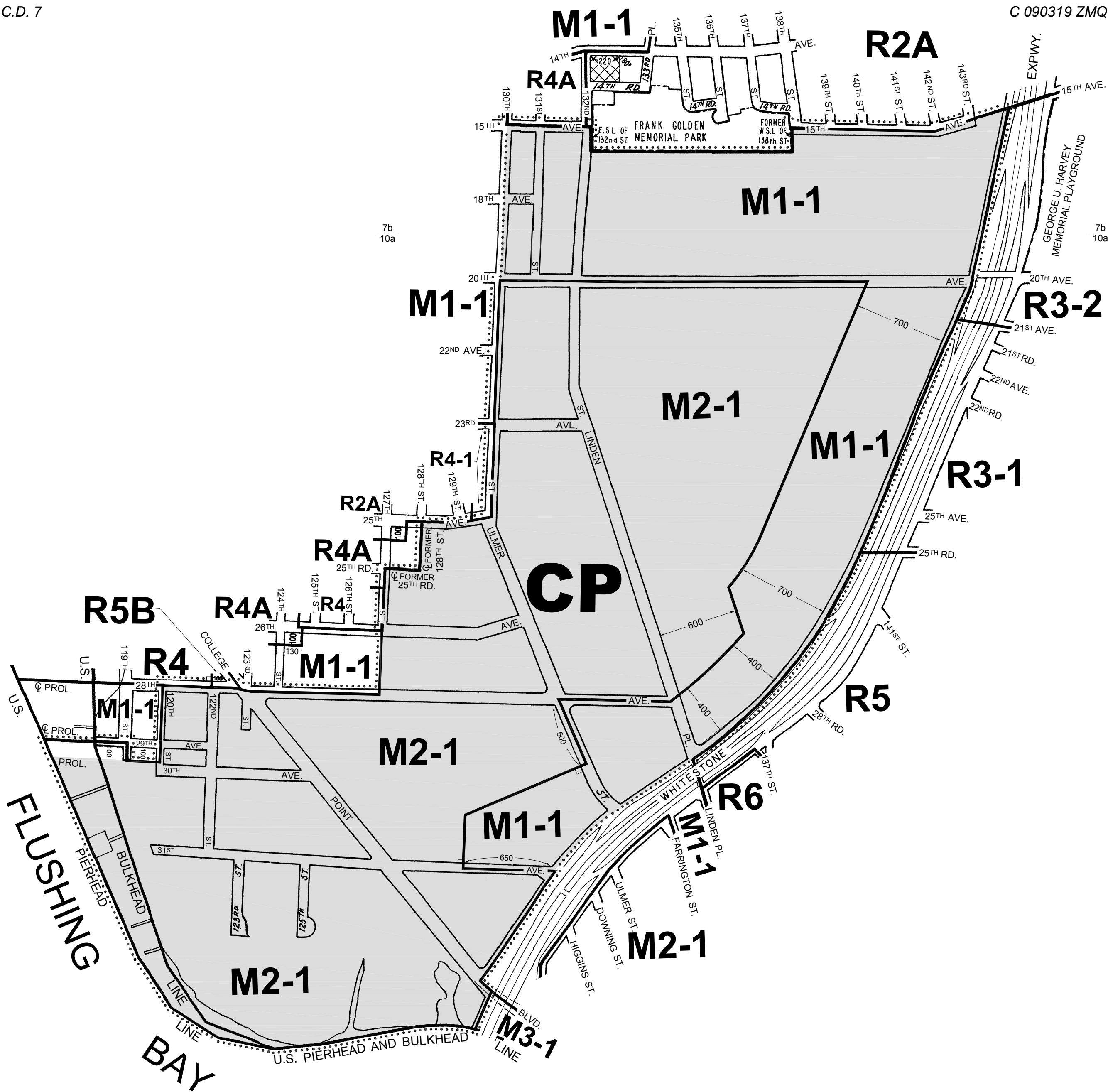

CITY PLANNING COMMISSION  
 CITY OF NEW YORK  
 DIAGRAM SHOWING  
**ZONING CHANGE**  
 ON SECTIONAL MAPS  
**7b & 10a**  
 BOROUGH OF  
**QUEENS**

EFFECTIVE DATE
July 29, 2009
C. C. RESO. # 2129

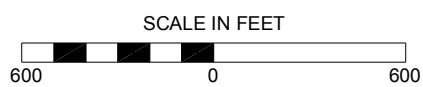

NOTE:

- Indicates Zoning District Boundary.
- ..... The area enclosed by the dotted line is rezoned by changing M1-1 and M3-1 Districts to M1-1 and M2-1 Districts, and by establishing a Special College Point District.
- CP** Indicates a Special College Point District.





CITY PLANNING COMMISSION  
 CITY OF NEW YORK  
 DIAGRAM SHOWING  
**ZONING CHANGE**  
 ON SECTIONAL MAPS  
**13c, 13d, 14a, 14b & 17c**  
 BOROUGH OF  
**QUEENS**

EFFECTIVE DATE  
**July 29, 2009**  
 C. C. RESO. # 2130

- NOTE:
- - - - - Indicates Zoning District Boundary.
  - . . . . . The areas enclosed by the dotted lines are rezoned by eliminating C1-2, C1-3, C2-2 and C2-3 Districts from R4 and R5 Districts, by changing from R3-2, R4, R4B, R5, M1-1, M1-4D Districts, to R3A, R4-1, R4A, R4B, R5B and R5D Districts, by establishing within existing R4 and R4A Districts, and by establishing within adopted R4-1, R4A, R4B, R5B and R5D Districts, C1-3 and C2-3 Districts.
  - [Symbol] Indicates a C1-2 District.
  - [Symbol] Indicates a C1-3 District.
  - [Symbol] Indicates a C2-2 District.
  - [Symbol] Indicates a C2-3 District.
  - (E) Indicates a City Environmental Quality Review Declaration, refer to C.E.Q.R. sheet.



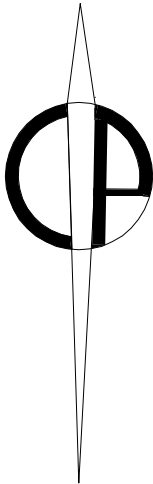
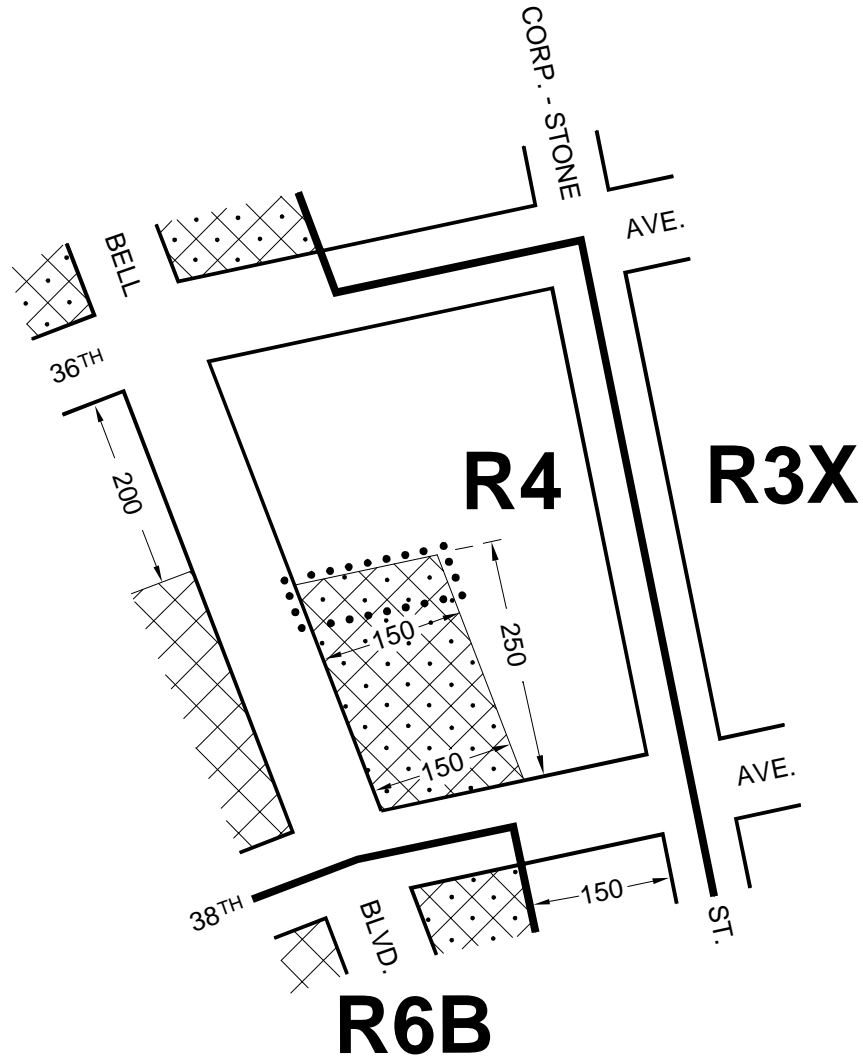



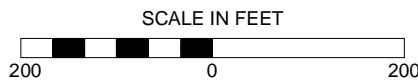

CITY PLANNING COMMISSION  
 CITY OF NEW YORK  
 DIAGRAM SHOWING  
**ZONING CHANGE**  
 ON SECTIONAL MAP  
**11a**  
 BOROUGH OF  
**QUEENS**

EFFECTIVE DATE  
**October 14, 2009**  
 C. C. RESO. # **2224**



- NOTE:
-  Indicates Zoning District Boundary.
  -  The area enclosed by the dotted line is rezoned by establishing a C2-2 District within an existing R4 District.
  -  Indicates a C1-2 District.
  -  Indicates a C2-2 District.



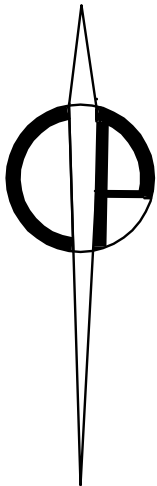
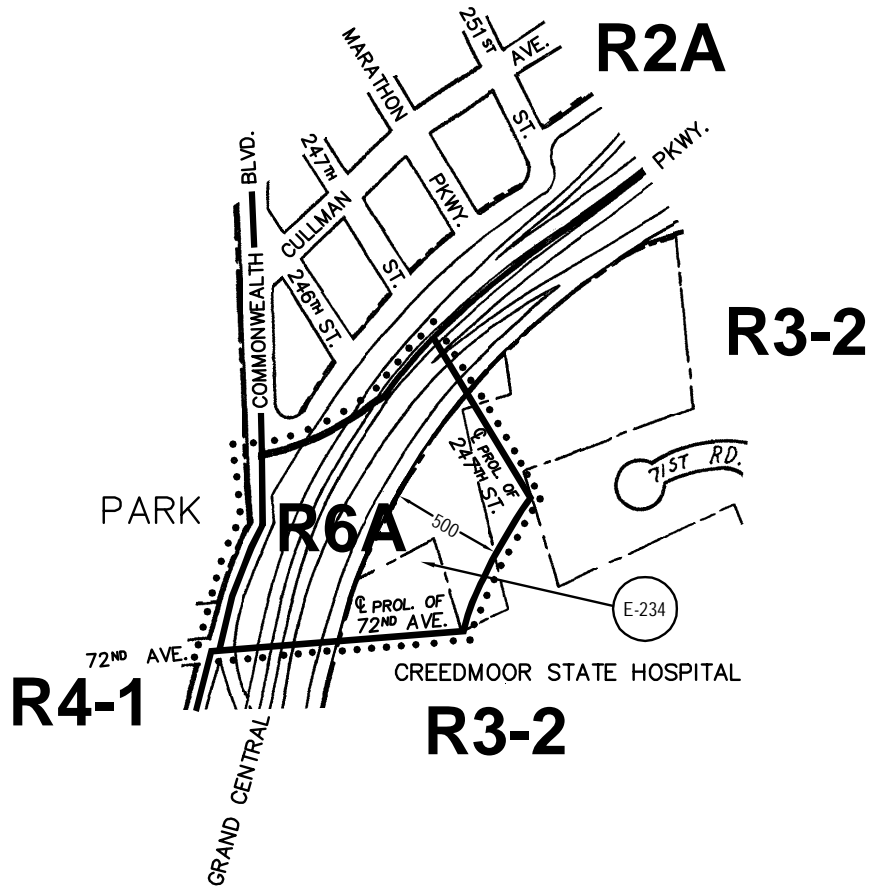

CITY PLANNING COMMISSION  
CITY OF NEW YORK

DIAGRAM SHOWING  
**ZONING CHANGE**  
ON SECTIONAL MAP  
**11d**  
BOROUGH OF  
**QUEENS**

EFFECTIVE DATE <b>October 14, 2009</b> C.C. RESO. # <b>2229</b>
---

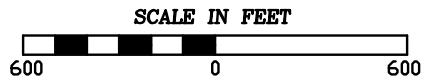

**NOTE:**

- Indicates Zoning District boundary.
- .....** The area enclosed by the dotted line is rezoned by changing from an R3-2 District to an R6A District.
- (E)** Indicates a City Environmental Quality Review Declaration, refer to C.E.Q.R. sheet.

# R3-2

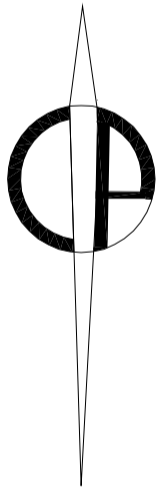
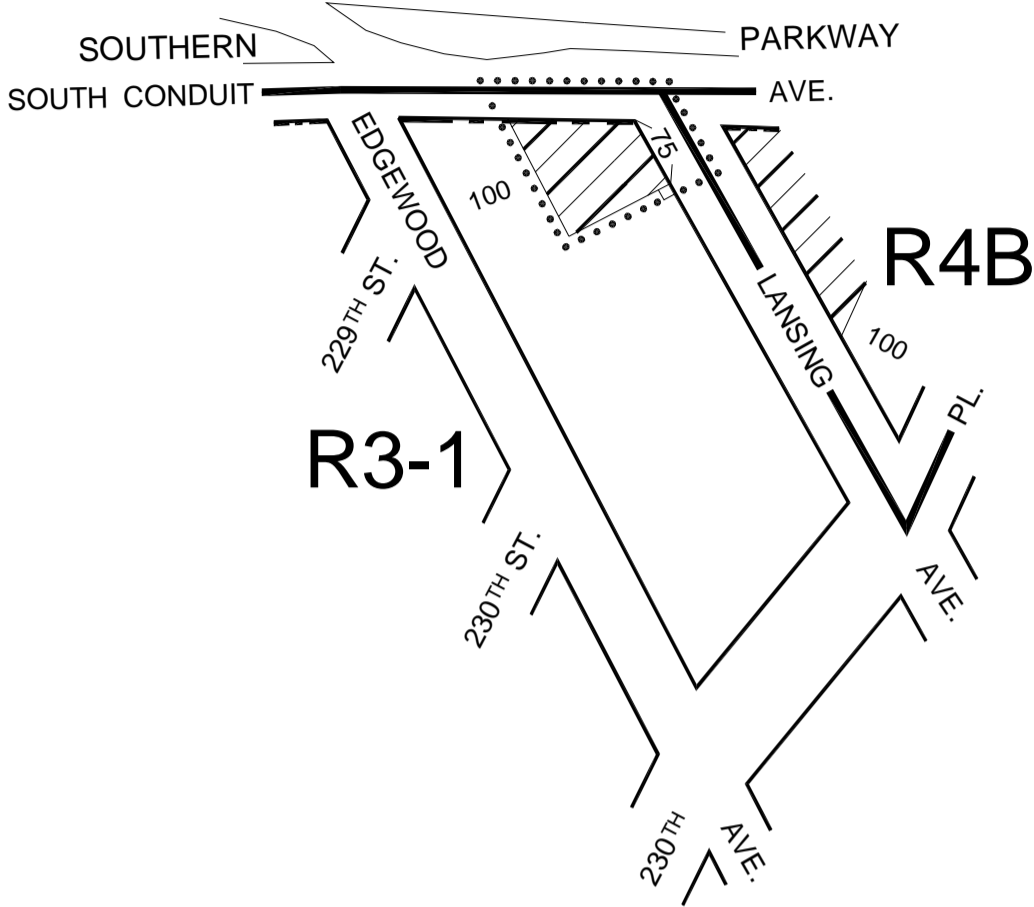

CITY PLANNING COMMISSION  
 CITY OF NEW YORK  
 DIAGRAM SHOWING  
**ZONING CHANGE**  
 ON SECTIONAL MAP  
**19b**  
 BOROUGH OF  
**QUEENS**

EFFECTIVE DATE  
**October 28, 2009**  
 C. C. RESO. # 2246





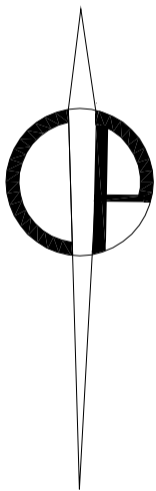
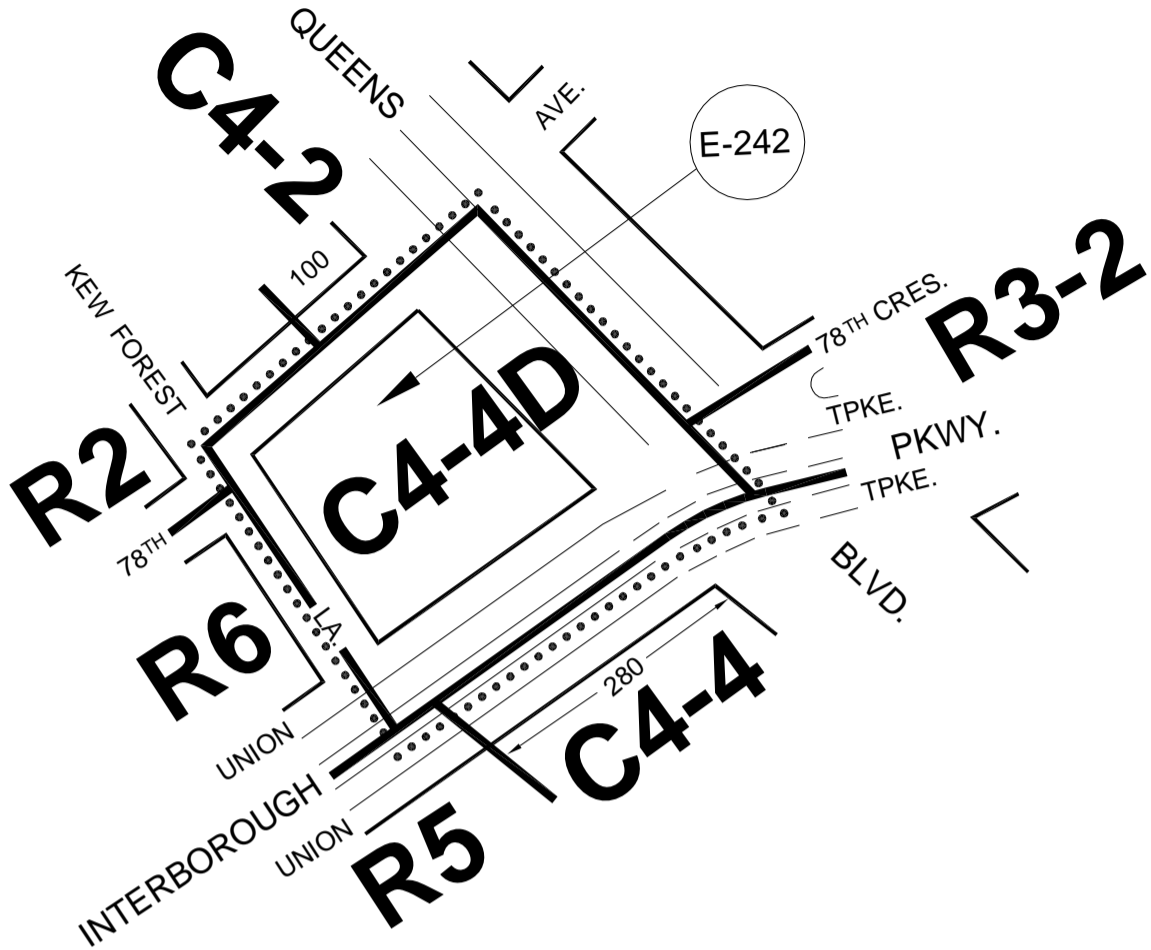

- NOTE:
- Indicates Zoning District Boundary.
  - The area enclosed by the dotted line is rezoned by establishing a C1-3 District within an existing R3-1 District.
  - Indicates a C1-3 District.

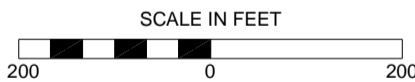

CITY PLANNING COMMISSION  
 CITY OF NEW YORK  
 DIAGRAM SHOWING  
**ZONING CHANGE**  
 ON SECTIONAL MAP  
**14b**  
 BOROUGH OF  
**QUEENS**

EFFECTIVE DATE  
**April 29, 2010**  
 C. C. RESO. # 217



- NOTE:**
-  Indicates Zoning District Boundary.
  -  The area enclosed by the dotted line is rezoned by changing C4-2, C4-4 and R6 Districts to a C4-4D District.
  -  Indicates a City Environmental Quality Review Declaration, refer to C.E.Q.R. sheet.

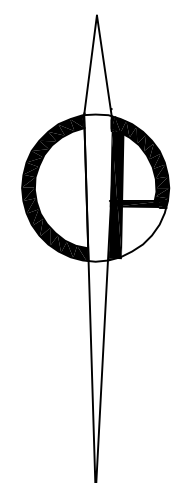
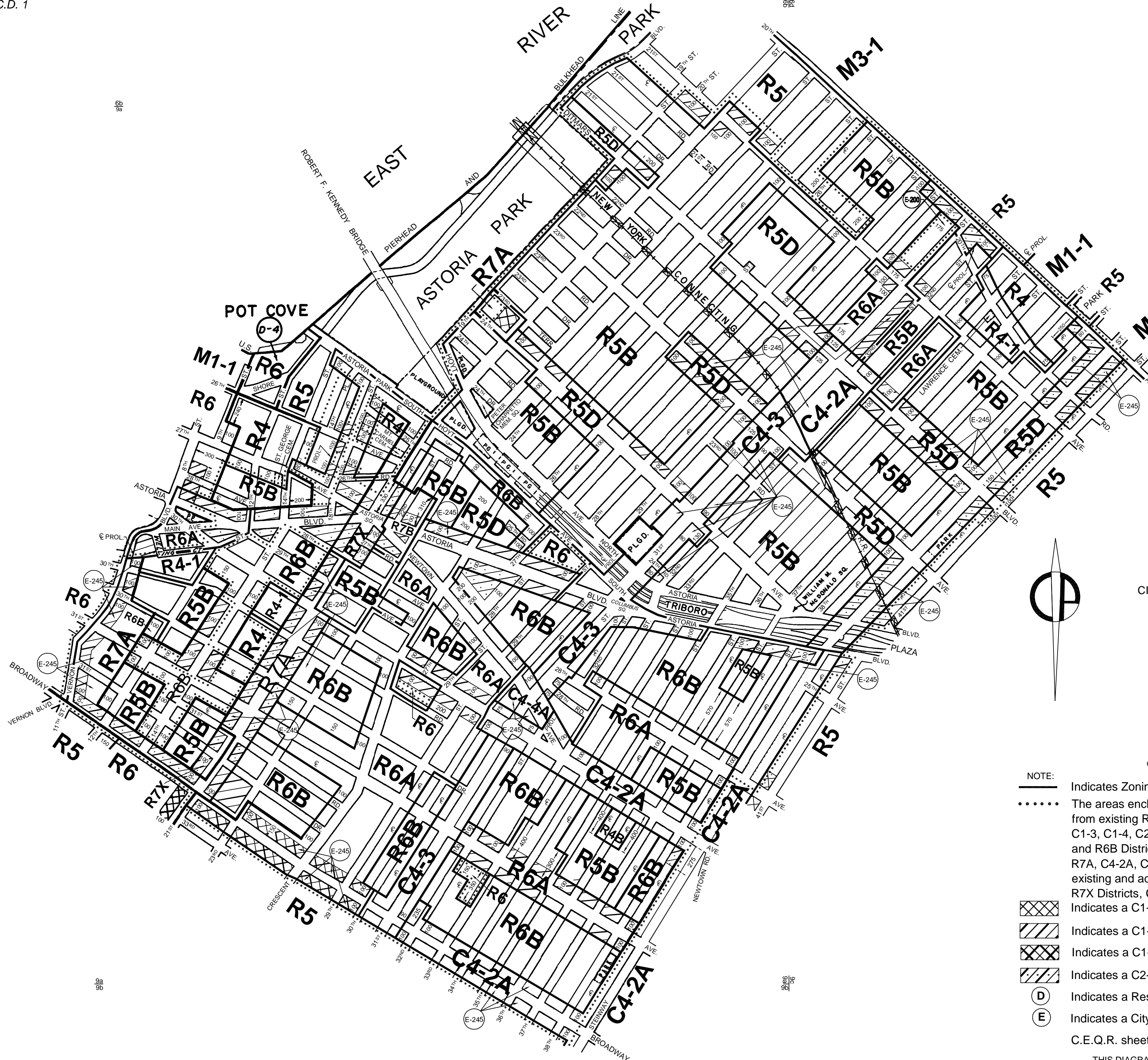

CITY PLANNING COMMISSION  
 CITY OF NEW YORK  
 DIAGRAM SHOWING  
**ZONING CHANGE**  
 ON SECTIONAL MAPS  
**6b, 9a, 9b & 9c**  
 BOROUGH OF  
 QUEENS

EFFECTIVE DATE  
**May 25, 2010**  
 C. C. RESO. # 258

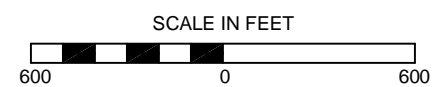

- NOTE:
- Indicates Zoning District Boundary.
  - ..... The areas enclosed by the dotted lines are rezoned by eliminating from existing R5, R6, R6A, R7A, R7B and R7X Districts C1-2, C1-3, C1-4, C2-2 and C2-4 Districts, changing from R4, R5, R6 and R6B Districts to R4, R4-1, R4B, R5, R5B, R5D, R6A, R6B, R7A, C4-2A, C4-3 and C4-4A Districts, and establishing within existing and adopted R5, R5B, R5D, R6A, R6B, R7A, R7B and R7X Districts, C1-3, C1-4 and C2-3 Districts.
  - ▨ Indicates a C1-2 District.
  - ▧ Indicates a C1-3 District.
  - ▩ Indicates a C1-4 District.
  - ▦ Indicates a C2-3 District.
  - (D) Indicates a Restrictive Declaration Area, refer to R.D. sheet.
  - (E) Indicates a City Environmental Quality Review Declaration, refer to C.E.Q.R. sheet.



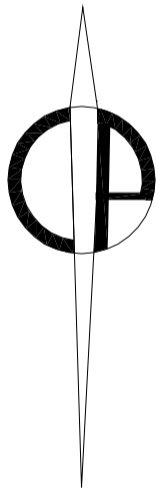
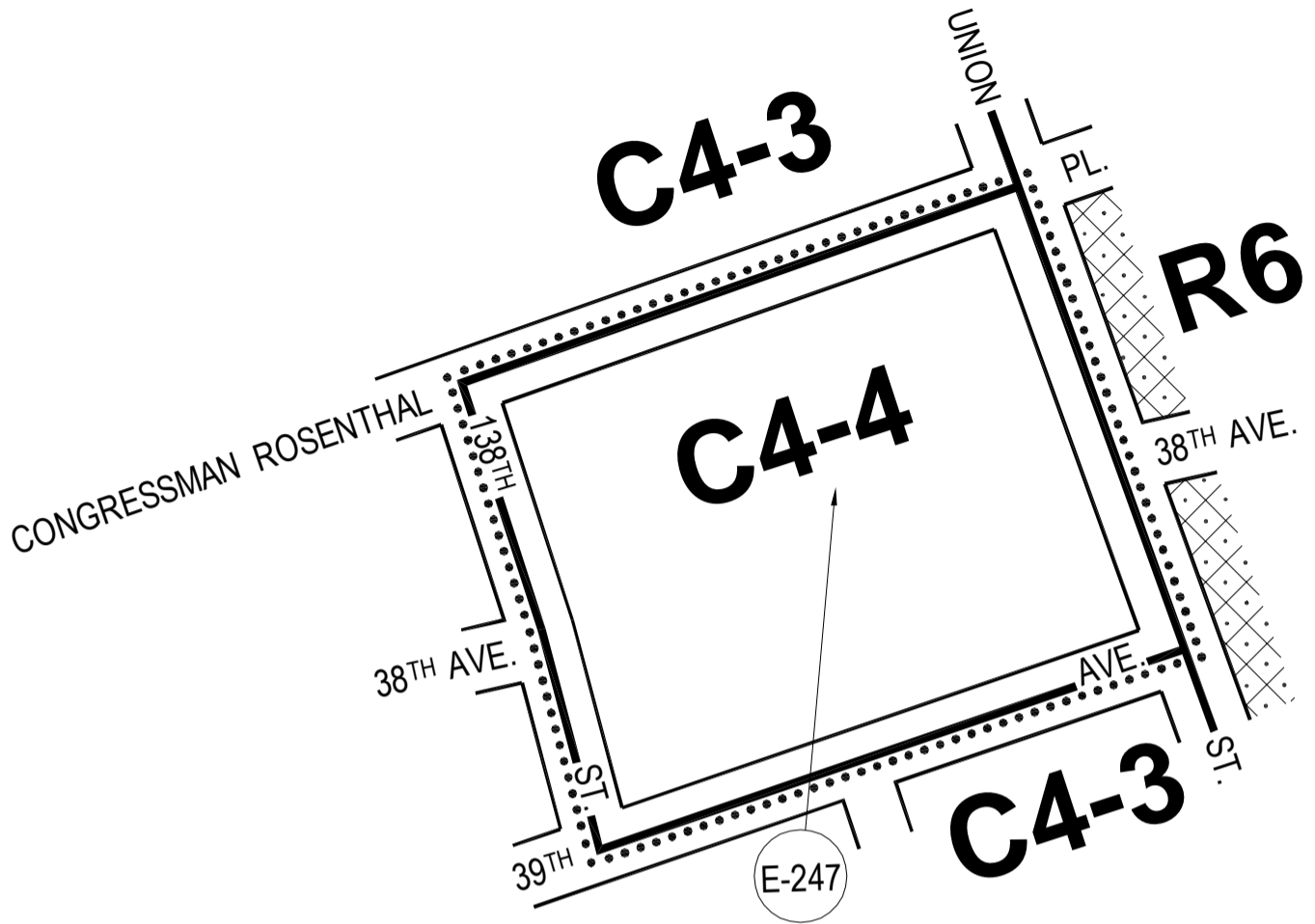

THIS DIAGRAM IS FOR ILLUSTRATIVE PURPOSES ONLY.



CITY PLANNING COMMISSION  
 CITY OF NEW YORK  
 DIAGRAM SHOWING  
**ZONING CHANGE**  
 ON SECTIONAL MAP  
**10a**  
 BOROUGH OF  
**QUEENS**

EFFECTIVE DATE  
**July 29, 2010**  
 C. C. RESO. # 381



- NOTE:**
-  Indicates Zoning District Boundary.
  -  The area enclosed by the dotted line is rezoned by changing from a C4-3 District to a C4-4 District.
  -  Indicates a C2-2 District.
  -  Indicates a City Environmental Quality Review Declaration, refer to C.E.Q.R. sheet.

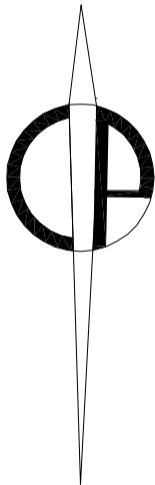
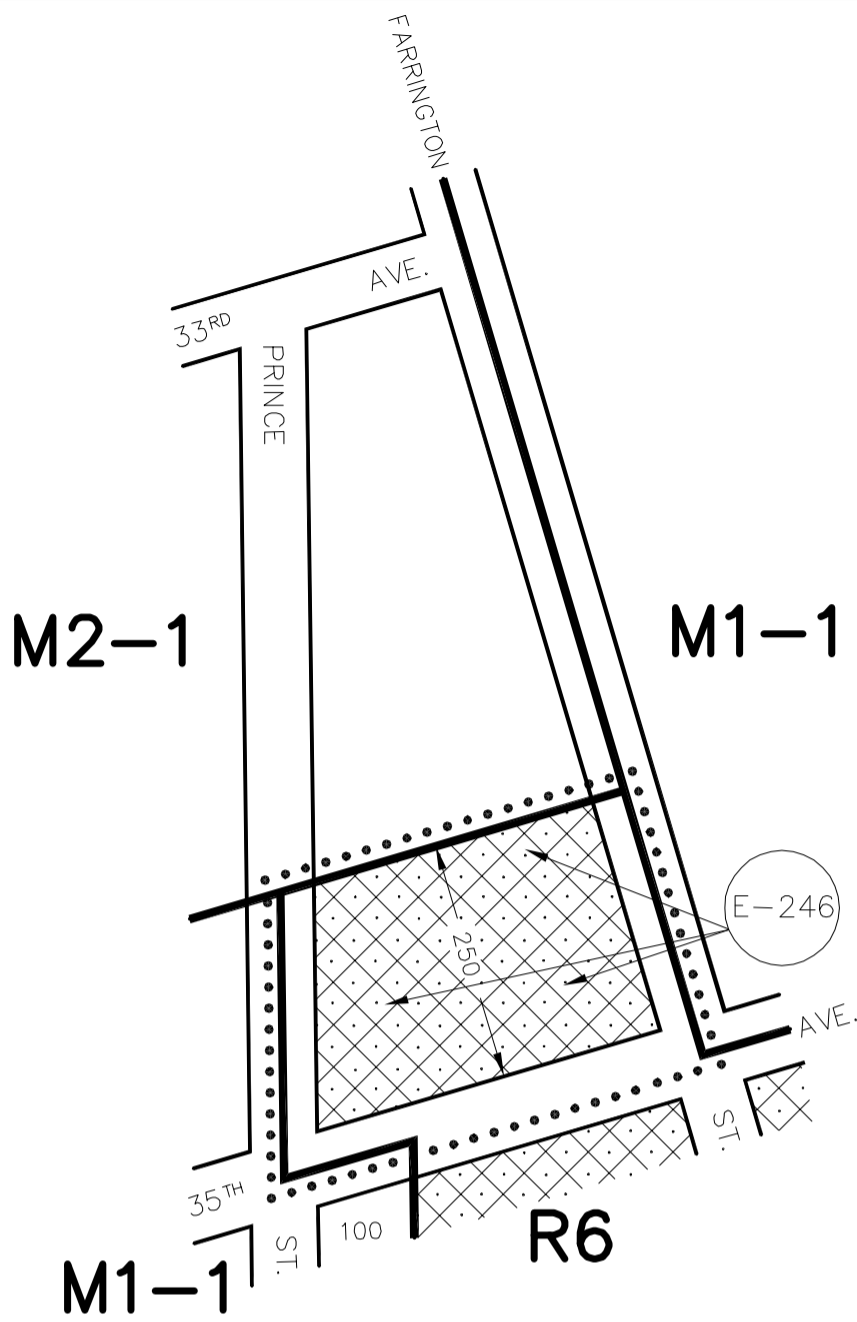

CITY PLANNING COMMISSION  
CITY OF NEW YORK



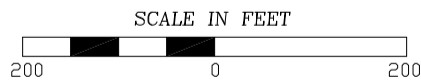
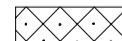

DIAGRAM SHOWING  
**ZONING CHANGE**  
ON SECTIONAL MAP

**10a**  
BOROUGH OF  
**QUEENS**

EFFECTIVE DATE  
July 29, 2010  
C. C. RESO. # 391



**NOTE:**

-  Indicates Zoning District boundary.
-  The area enclosed by the dotted line is rezoned by changing an M1-1 District to an R6 District and establishing within the adopted R6 District a C2-2 District.
-  Indicates a C2-2 District.
-  Indicates a City Environmental Quality Review Declaration, refer to C.E.Q.R. sheet.

THIS DIAGRAM IS FOR ILLUSTRATIVE PURPOSES ONLY.

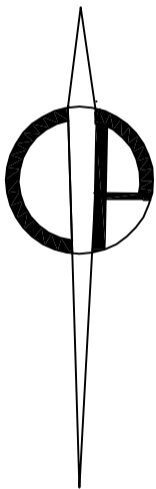
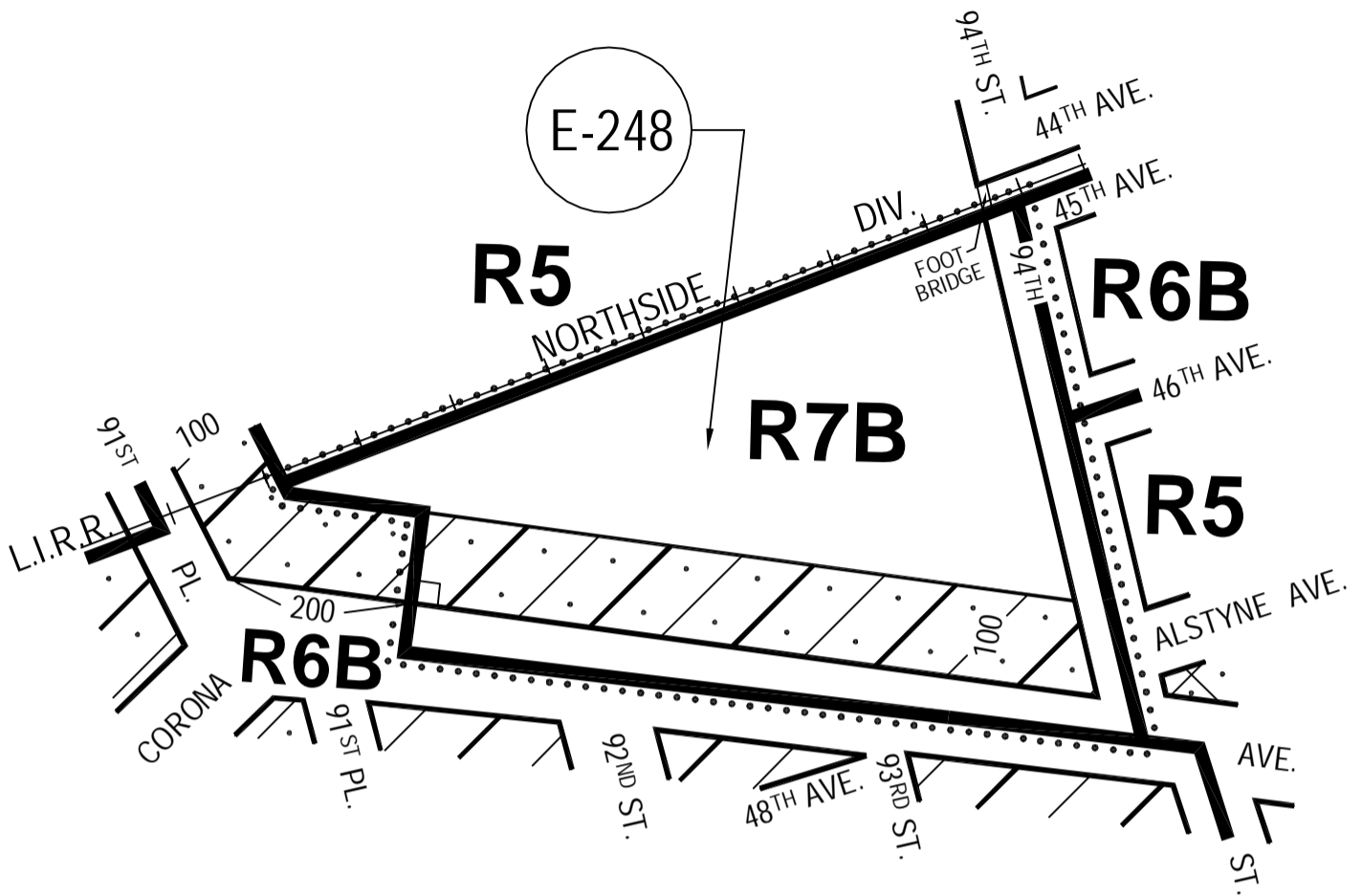



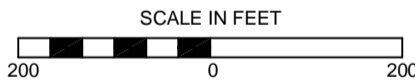



CITY PLANNING COMMISSION  
 CITY OF NEW YORK  
 DIAGRAM SHOWING  
**ZONING CHANGE**  
 ON SECTIONAL MAP  
**9d**  
 BOROUGH OF  
**QUEENS**



EFFECTIVE DATE  
**July 29, 2010**  
 C. C. RESO. # 392

NOTE:



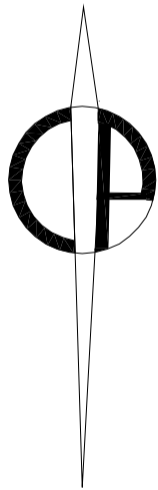
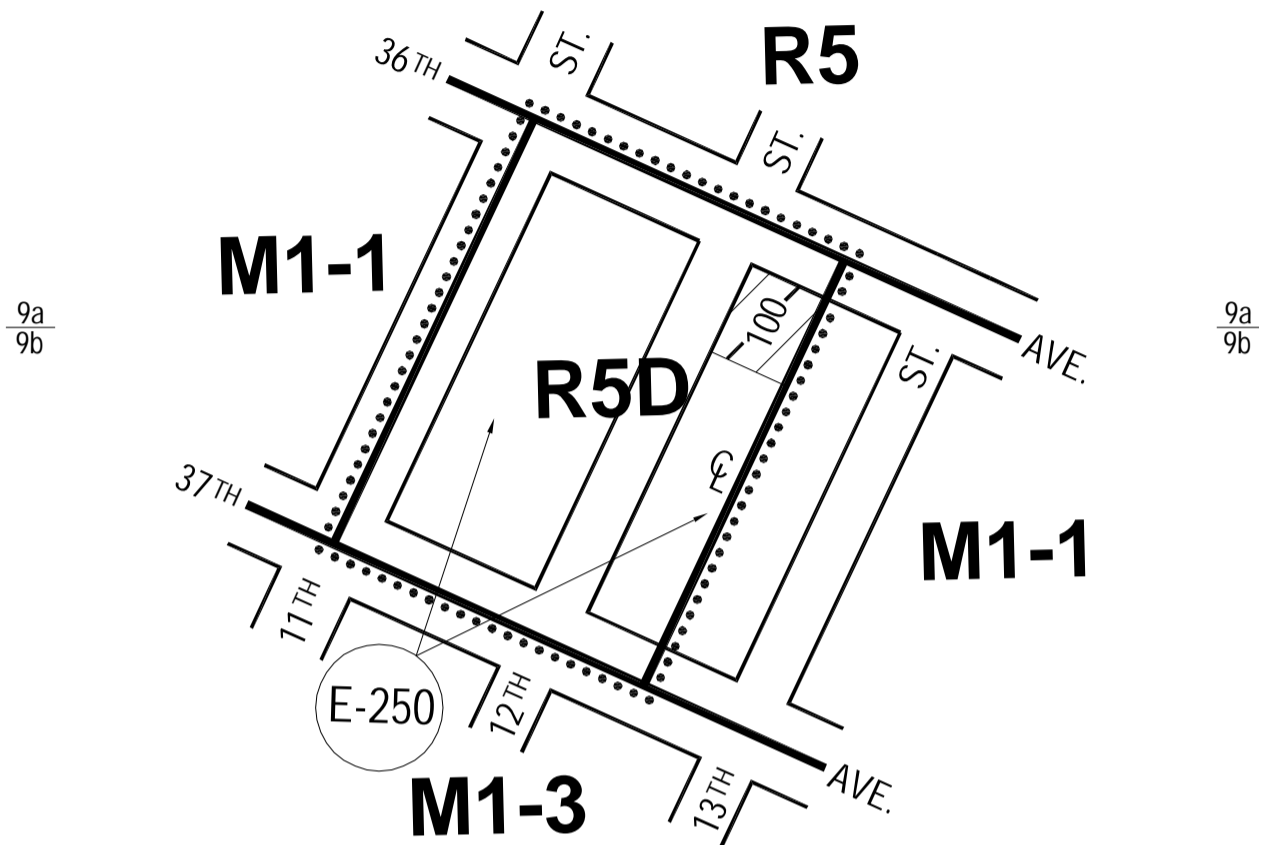

-  Indicates Zoning District Boundary.
-  The area enclosed by the dotted line is rezoned by changing from an M1-1 District to an R7B District and by establishing a C2-3 within the adopted R7B District.
-  Indicates a C1-3 District.
-  Indicates a C2-2 District.
-  Indicates a C2-3 District.
-  Indicates a City Environmental Quality Review Declaration, refer to C.E.Q.R. sheet.

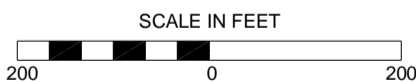

CITY PLANNING COMMISSION  
 CITY OF NEW YORK  
 DIAGRAM SHOWING  
**ZONING CHANGE**  
 ON SECTIONAL MAPS  
**9a & 9b**  
 BOROUGH OF  
**QUEENS**

EFFECTIVE DATE  
**September 16, 2010**  
 C. C. RESO. # 458



- NOTE:
-  Indicates Zoning District Boundary.
  -  The area enclosed by the dotted line is rezoned by changing from an M1-1 District to an R5D District and by establishing a C1-3 District within an adopted R5D District.
  -  Indicates a C1-3 District.
  -  Indicates a City Environmental Quality Review Declaration, refer to C.E.Q.R. sheet.



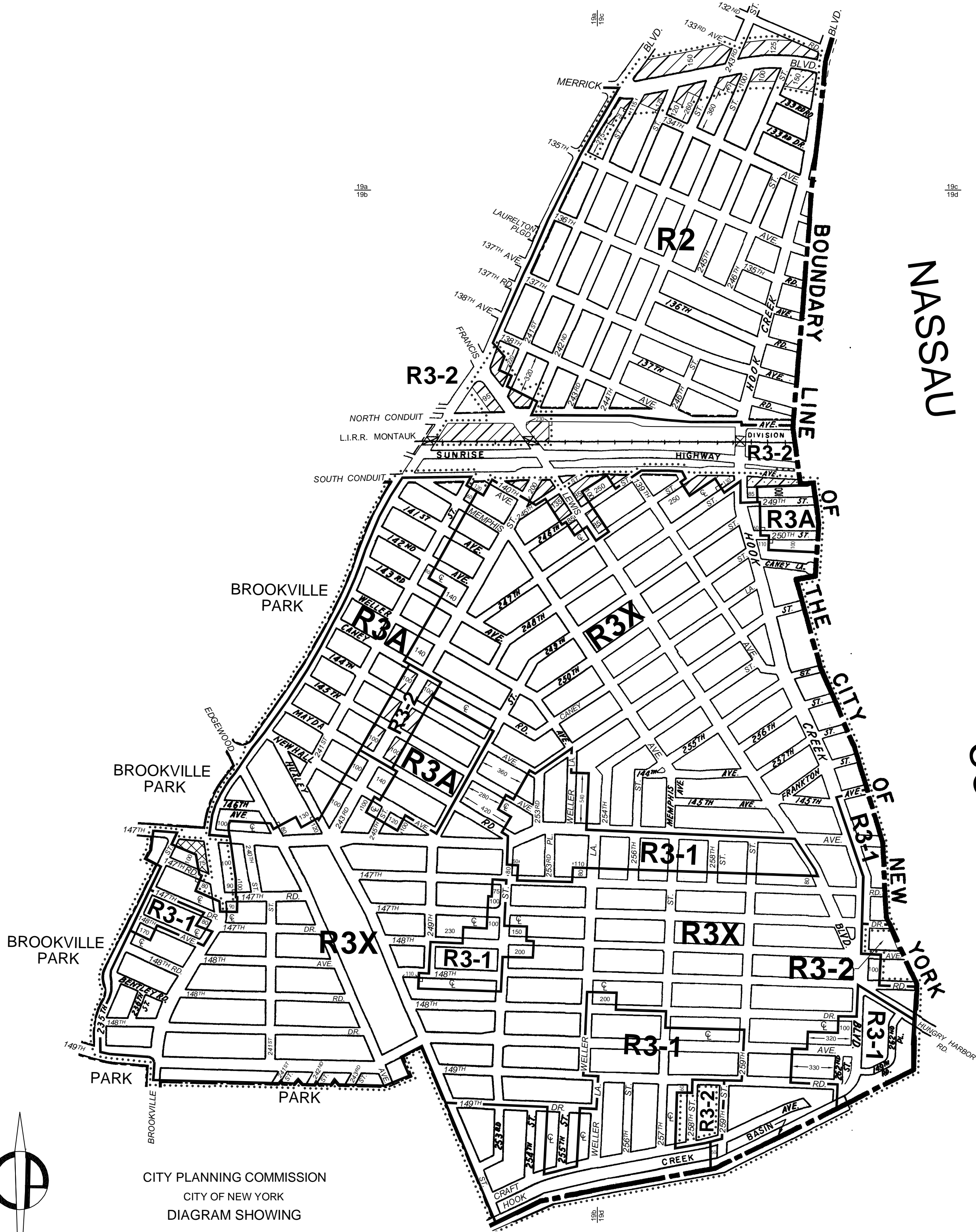

NASSAU COUNTY

CITY OF NEW YORK

NEW YORK COUNTY

CITY PLANNING COMMISSION  
 CITY OF NEW YORK  
 DIAGRAM SHOWING  
**ZONING CHANGE**  
 ON SECTIONAL MAPS  
**19a, 19b, 19c & 19d**  
 BOROUGH OF  
**THE BRONX**

EFFECTIVE DATE  
**September 16, 2010**  
 C. C. RESO. # 459

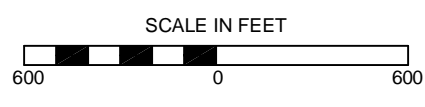

- NOTE:
- Indicates Zoning District Boundary.
  - The areas enclosed by the dotted lines are rezoned by eliminating C1-1, C1-2 and C2-1 District from existing R2 and R3-2 Districts, by changing an R3-2 District to R2, R3A, R3X and R3-1 Districts, and by establishing C1-2, C1-3 and C2-3 Districts within existing R2 and R3-2 Districts.
  - ▨ Indicates a C1-1 District.
  - ▩ Indicates a C1-2 District.
  - ▧ Indicates a C1-3 District.
  - ▦ Indicates a C2-3 District.

THIS DIAGRAM IS FOR ILLUSTRATIVE PURPOSES ONLY.

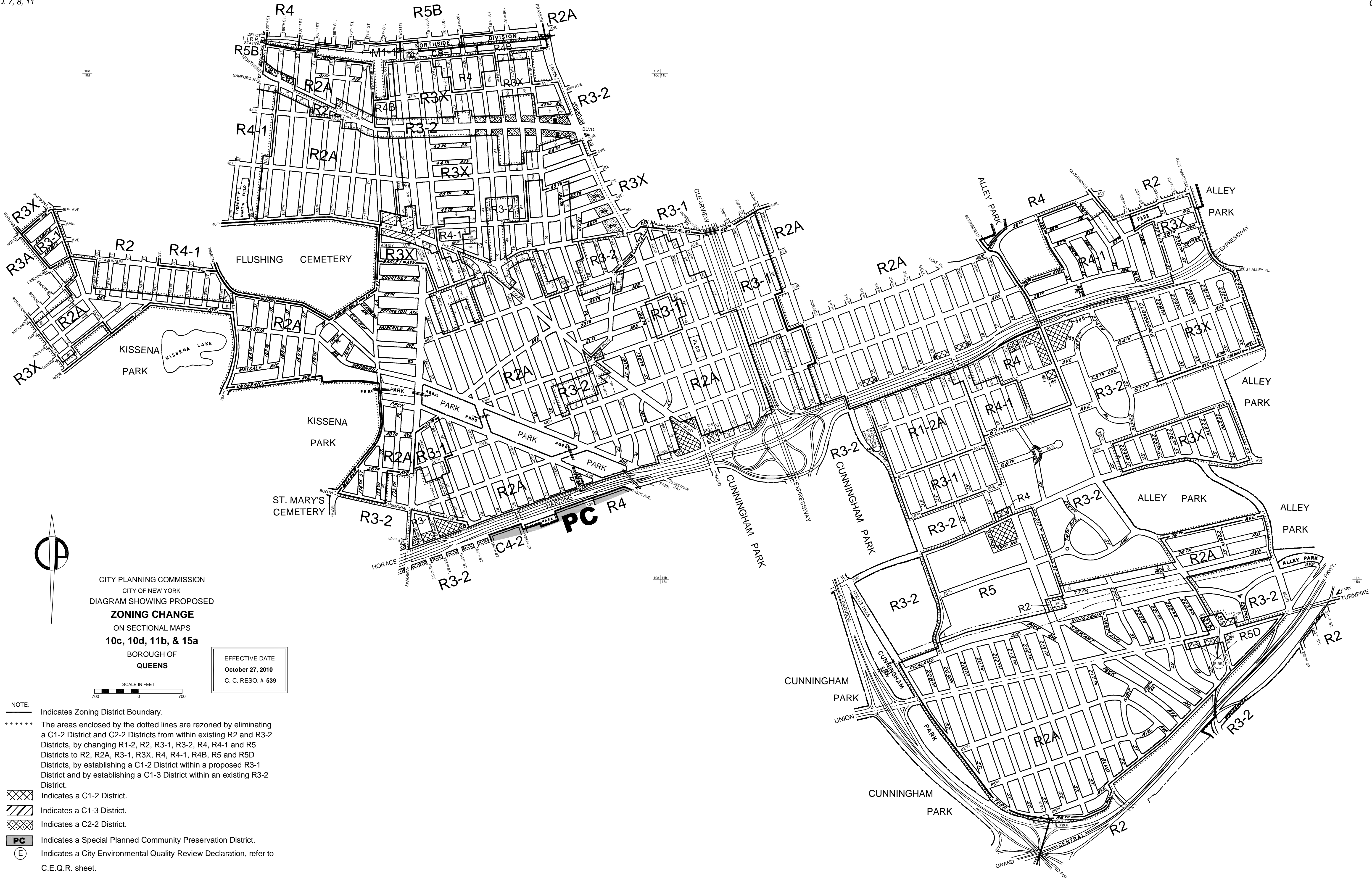

CITY PLANNING COMMISSION  
 CITY OF NEW YORK  
 DIAGRAM SHOWING PROPOSED  
**ZONING CHANGE**  
 ON SECTIONAL MAPS  
**10c, 10d, 11b, & 15a**  
 BOROUGH OF  
**QUEENS**

EFFECTIVE DATE  
**October 27, 2010**  
 C. C. RESO. # 539

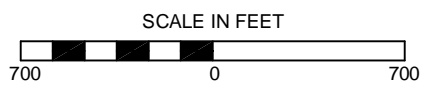

- NOTE:**
- ..... Indicates Zoning District Boundary.
  - ..... The areas enclosed by the dotted lines are rezoned by eliminating a C1-2 District and C2-2 Districts from within existing R2 and R3-2 Districts, by changing R1-2, R2, R3-1, R3-2, R4, R4-1 and R5 Districts to R2, R2A, R3-1, R3X, R4, R4-1, R4B, R5 and R5D Districts, by establishing a C1-2 District within a proposed R3-1 District and by establishing a C1-3 District within an existing R3-2 District.
  - XXXX Indicates a C1-2 District.
  - XXXX Indicates a C1-3 District.
  - XXXX Indicates a C2-2 District.
  - PC** Indicates a Special Planned Community Preservation District.
  - (E)** Indicates a City Environmental Quality Review Declaration, refer to C.E.Q.R. sheet.



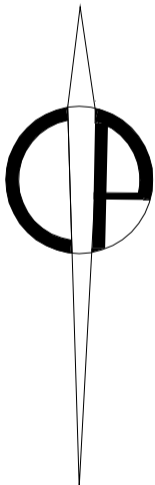
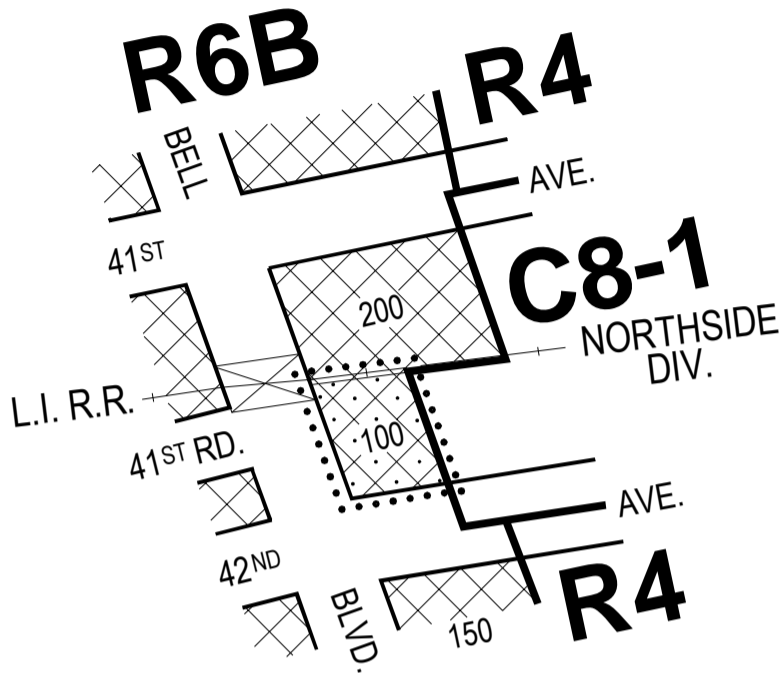

THIS DIAGRAM IS FOR ILLUSTRATIVE PURPOSES ONLY.



**ZONING CHANGE**  
 ON SECTIONAL MAP  
**11a**  
 BOROUGH OF  
**QUEENS**

EFFECTIVE DATE  
**January 18, 2011**  
 C. C. RESO. # **640**



- NOTE:**
-  Indicates Zoning District Boundary.
  -  The area enclosed by the dotted line is rezoned by eliminating a C1-2 District from an existing R6B District and establishing within an existing R6B District a C2-2 District.
  -  Indicates a C1-2 District.
  -  Indicates a C2-2 District.



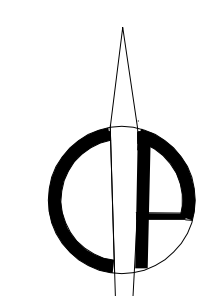
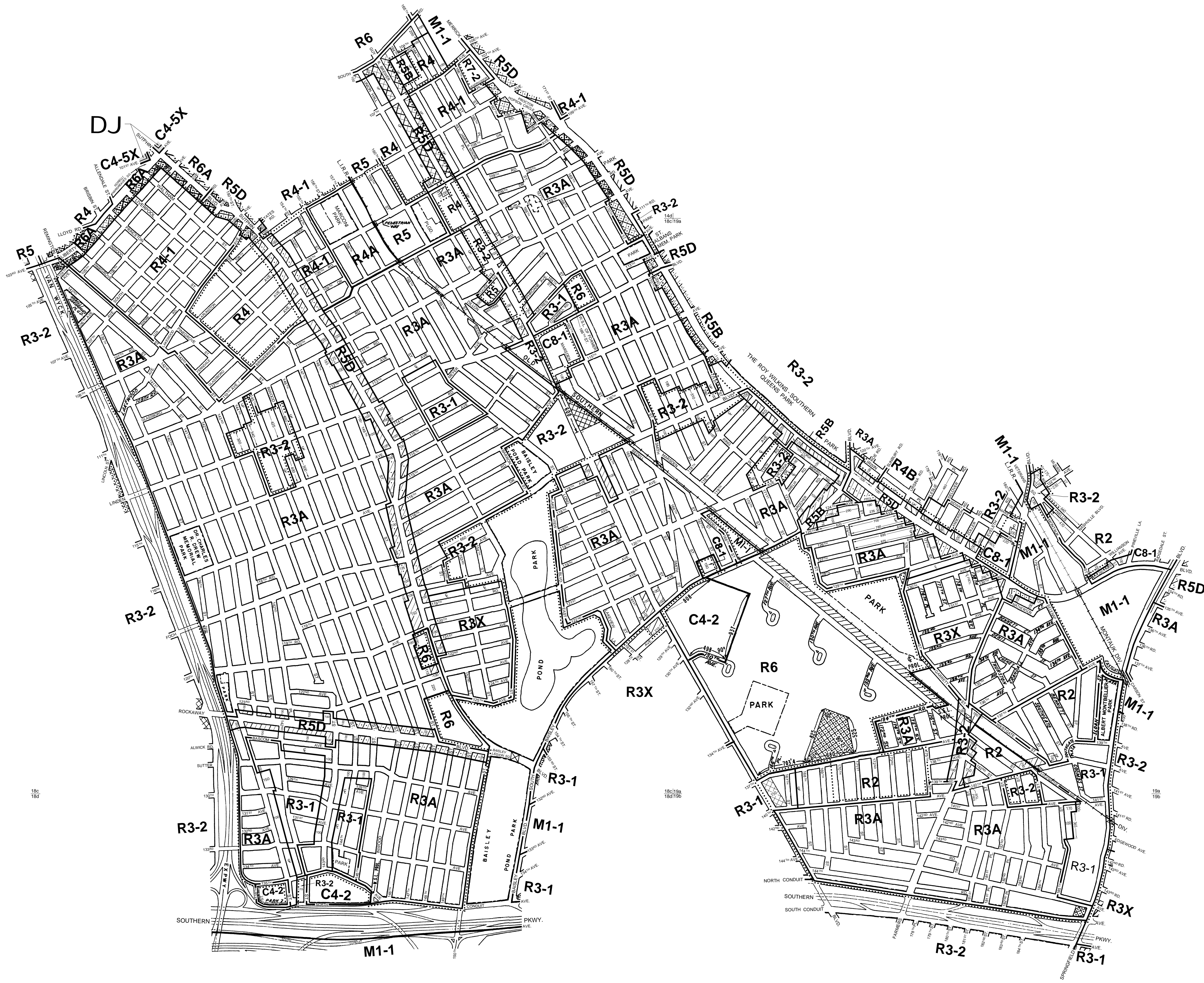

CITY PLANNING COMMISSION  
 CITY OF NEW YORK  
 DIAGRAM SHOWING  
**ZONING CHANGE**  
 ON SECTIONAL MAPS  
**14d, 18c, 18d, 19a & 19b**  
 BOROUGH OF  
**QUEENS**

EFFECTIVE DATE  
 May 11, 2011  
 C. C. RESO. # 828

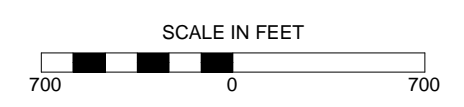

NOTE:  
 - - - - - Indicates Zoning District Boundary.  
 ..... The areas enclosed by the dotted lines are rezoned by eliminating C1-2, C1-3, C1-4, C2-2 and C2-3 Districts from within existing R3-2, R3A, R4, R4B, R5B and R6 Districts, by changing R2, R3-2, R3A, R4, R4B, R5B, C8-1 and M1-1 Districts to R2, R3-2, R3A, R3X, R4-1, R4A, R5B and R5D Districts, and by establishing C1-2, C1-3, C1-4 and C2-3 Districts within existing and proposed R2, R3-1, R3-2, R3A, R3X, R4, R5B and R5D Districts.

- Indicates a C1-1 District.
- Indicates a C1-2 District.
- Indicates a C1-3 District.
- Indicates a C2-2 District.
- Indicates a C2-3 District.
- Indicates a C2-4 District.
- Indicates a Special Downtown Jamaica District.

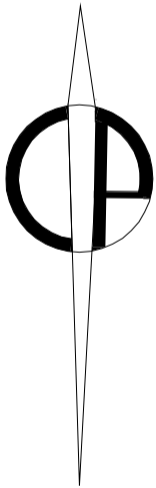
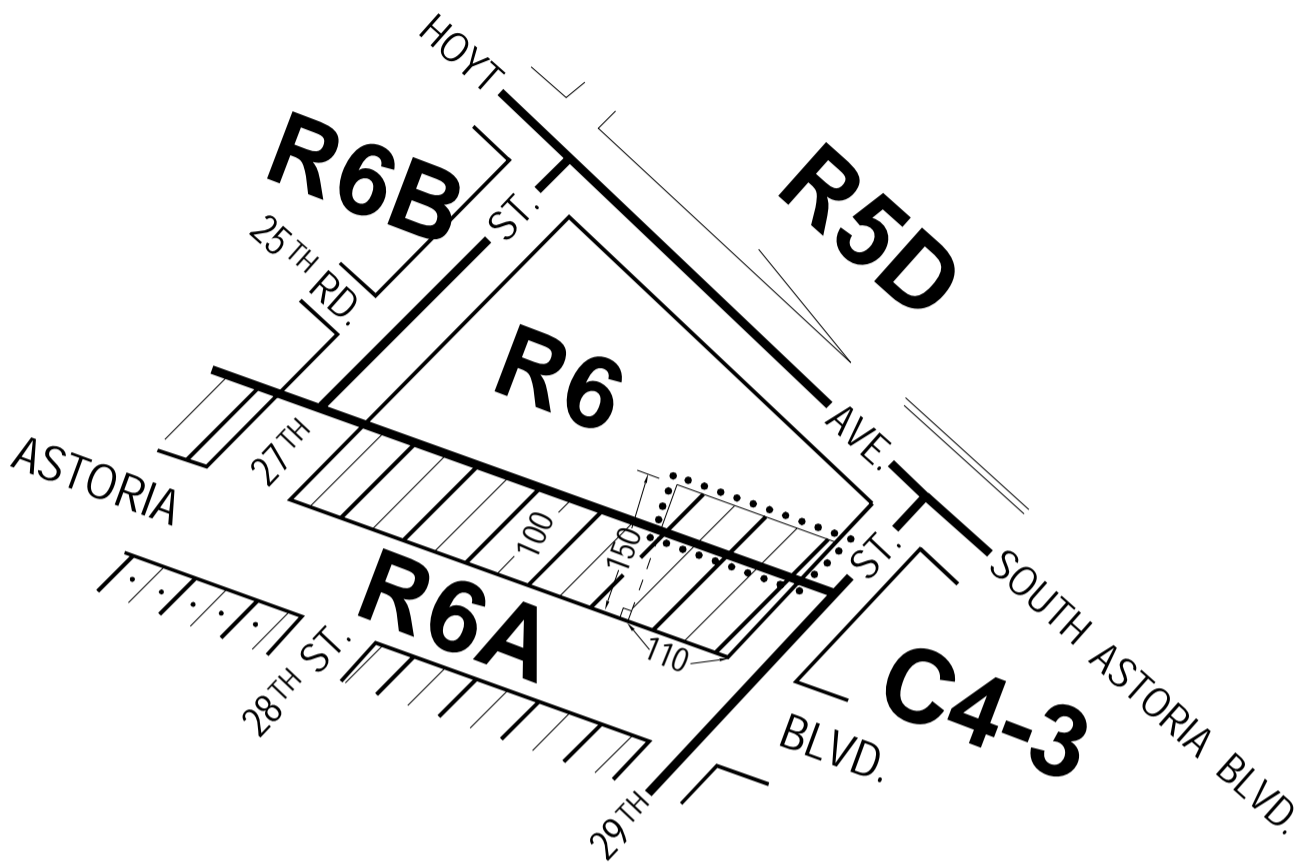

CITY PLANNING COMMISSION  
 CITY OF NEW YORK  
 DIAGRAM SHOWING  
**ZONING CHANGE**  
 ON SECTIONAL MAP  
**9a**  
 BOROUGH OF  
**QUEENS**

EFFECTIVE DATE  
**June 14, 2011**  
 C. C. RESO. # **883**



- NOTE:
- Indicates Zoning District Boundary.
  - The area enclosed by the dotted line is rezoned by establishing a C1-3 District within an existing R6 District.
  - Indicates a C1-3 District.
  - Indicates a C2-3 District.

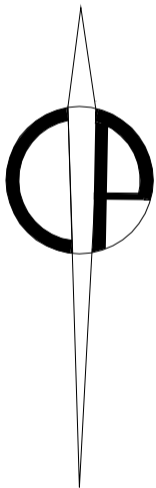
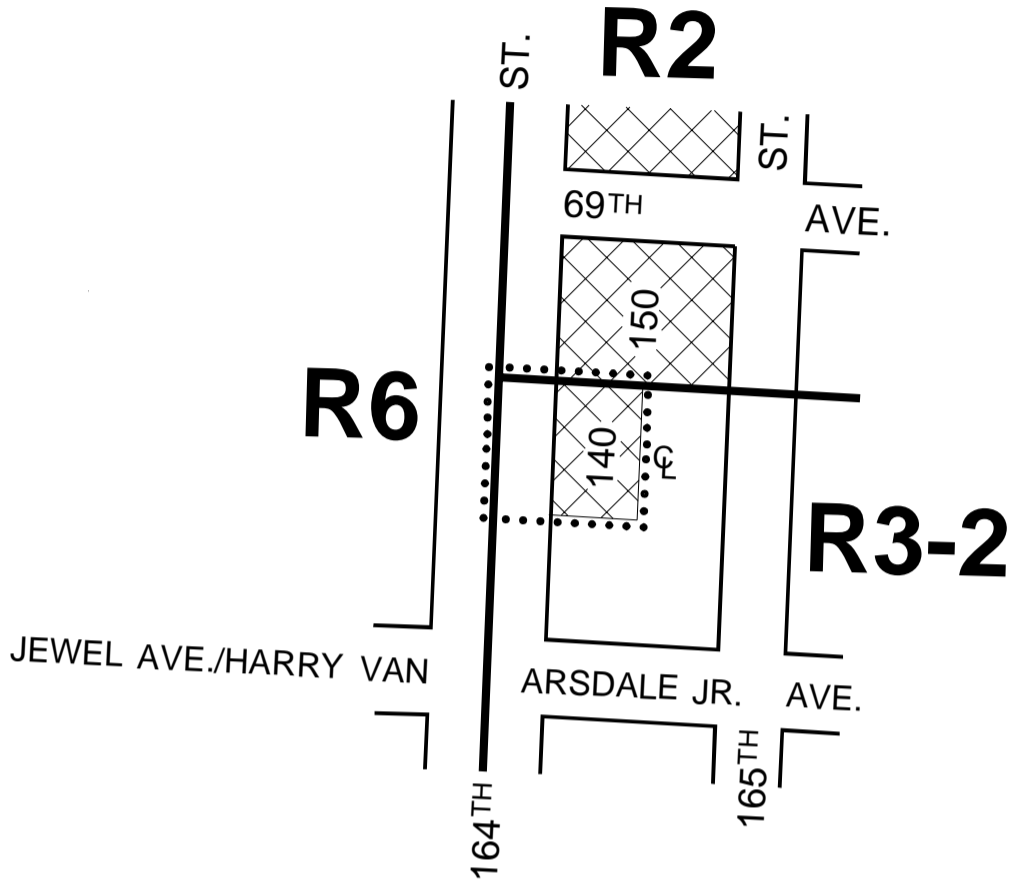

CITY PLANNING COMMISSION  
 CITY OF NEW YORK  
 DIAGRAM SHOWING  
**ZONING CHANGE**  
 ON SECTIONAL MAP  
**14c**  
 BOROUGH OF  
**QUEENS**

EFFECTIVE DATE  
**June 29, 2011**  
 C. C. RESO. # 941



- NOTE:
- Indicates Zoning District Boundary.
  - The area enclosed by the dotted line is rezoned by establishing a C1-2 District within an existing R3-2 District.
  - Indicates a C1-2 District.

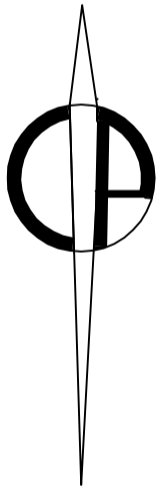
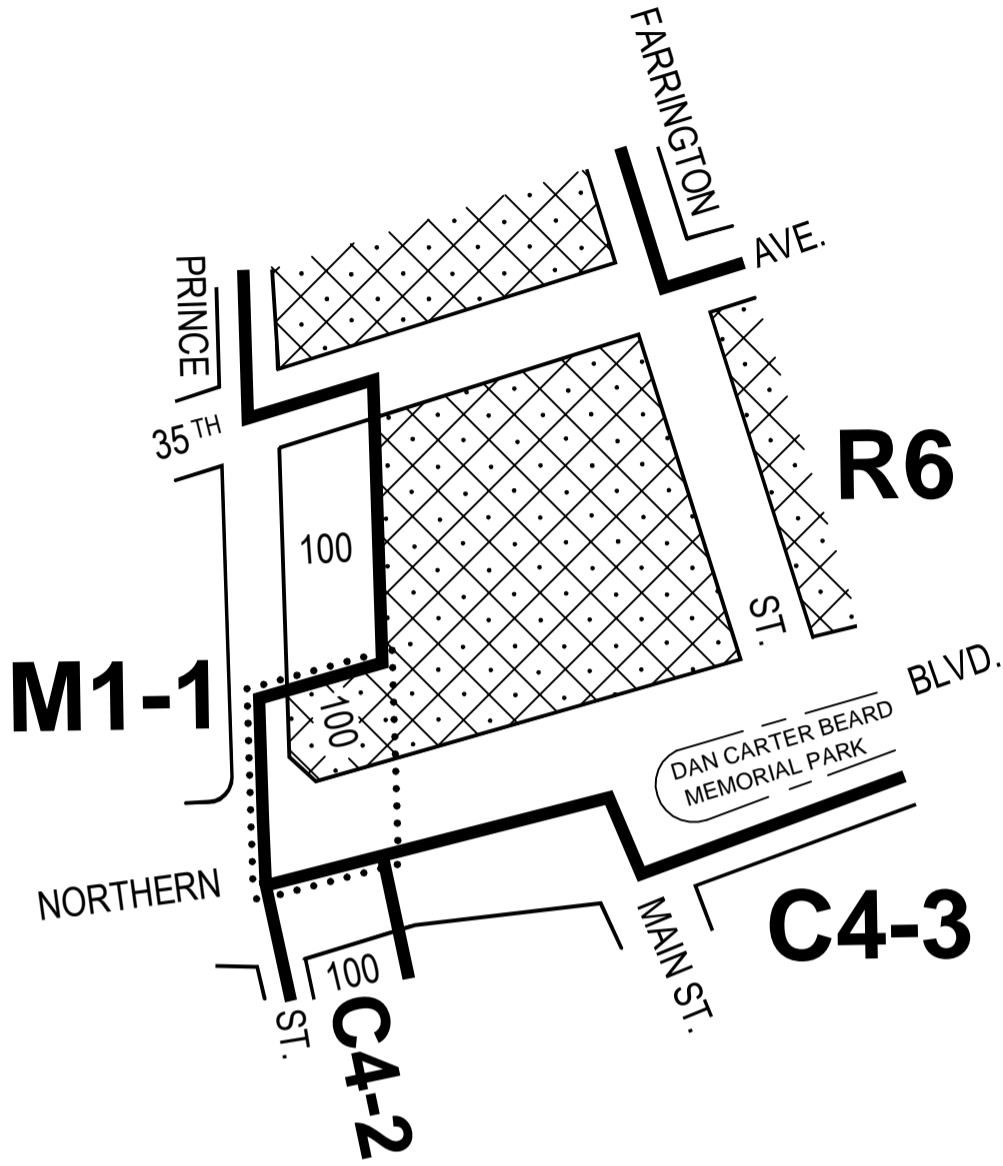

CITY PLANNING COMMISSION  
 CITY OF NEW YORK  
 DIAGRAM SHOWING  
**ZONING CHANGE**  
 ON SECTIONAL MAP  
**10a**  
 BOROUGH OF  
**QUEENS**

EFFECTIVE DATE  
**June 29, 2011**  
 C. C. RESO. # 945

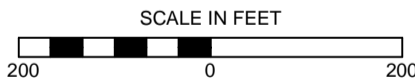



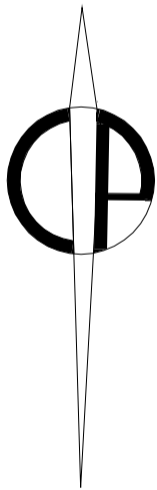
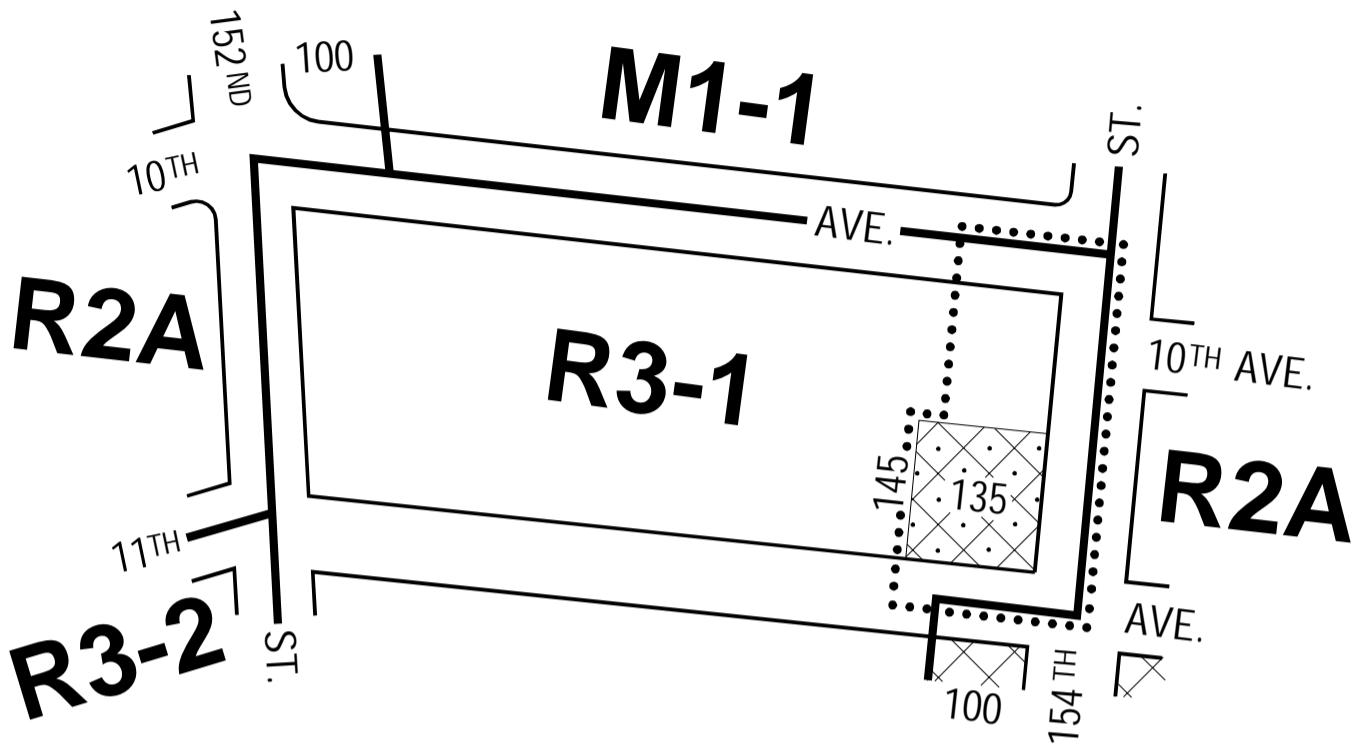

- NOTE:
- Indicates Zoning District Boundary.
  - The area enclosed by the dotted line is rezoned by changing from an M1-1 District to an R6 District and by establishing a C2-2 District within the proposed R6 District.
  - Indicates a C2-2 District.



CITY PLANNING COMMISSION  
 CITY OF NEW YORK  
 DIAGRAM SHOWING  
**ZONING CHANGE**  
 ON SECTIONAL MAP  
**7d**  
 BOROUGH OF  
**QUEENS**

EFFECTIVE DATE  
**June 29, 2011**  
 C. C. RESO. # 951



- NOTE:
-  Indicates Zoning District Boundary.
  -  The area enclosed by the dotted line is rezoned by changing from an R2A District to an R3-1 District and by establishing a C2-2 District within an existing and proposed R3-1 District.
  -  Indicates a C1-2 District.
  -  Indicates a C2-2 District.



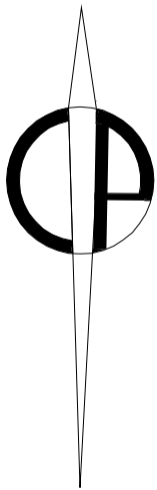
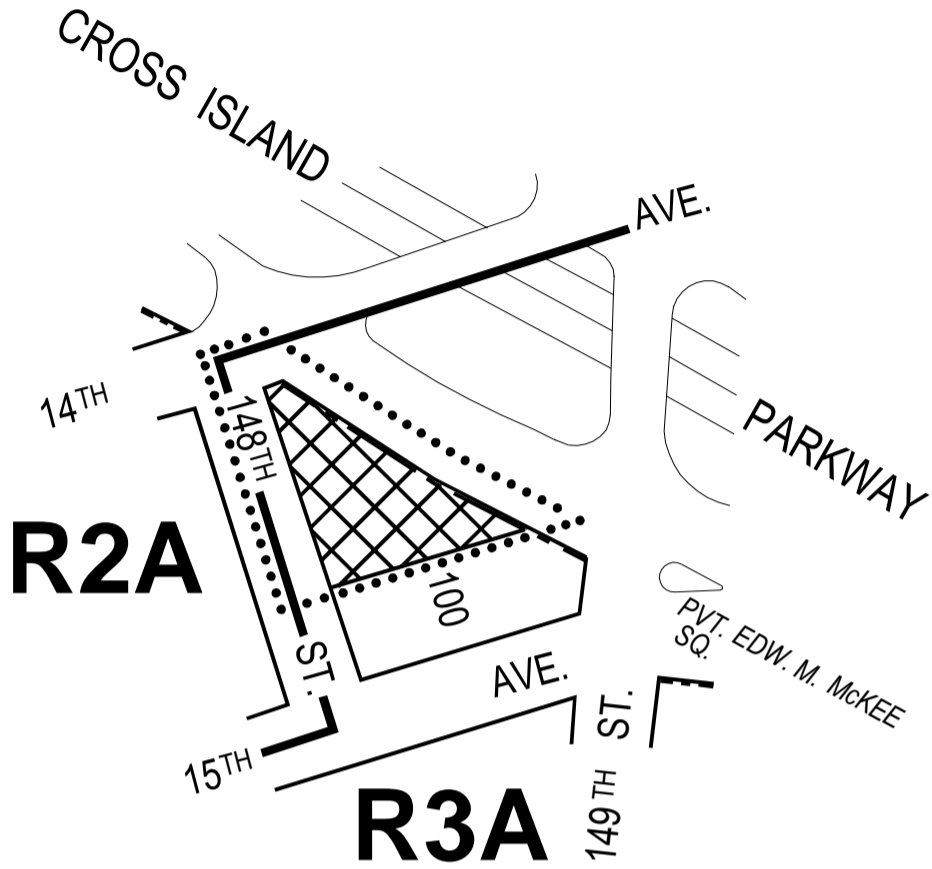



CITY PLANNING COMMISSION  
 CITY OF NEW YORK  
 DIAGRAM SHOWING  
**ZONING CHANGE**  
 ON SECTIONAL MAP  
**7d**  
 BOROUGH OF  
**QUEENS**

EFFECTIVE DATE  
**July 28, 2011**  
 C. C. RESO. # 968



- NOTE:
-  Indicates Zoning District Boundary.
  -  The area enclosed by the dotted line is rezoned by establishing a C1-2 District within an existing R3A District.
  -  Indicates a C1-2 District.

9b|9d

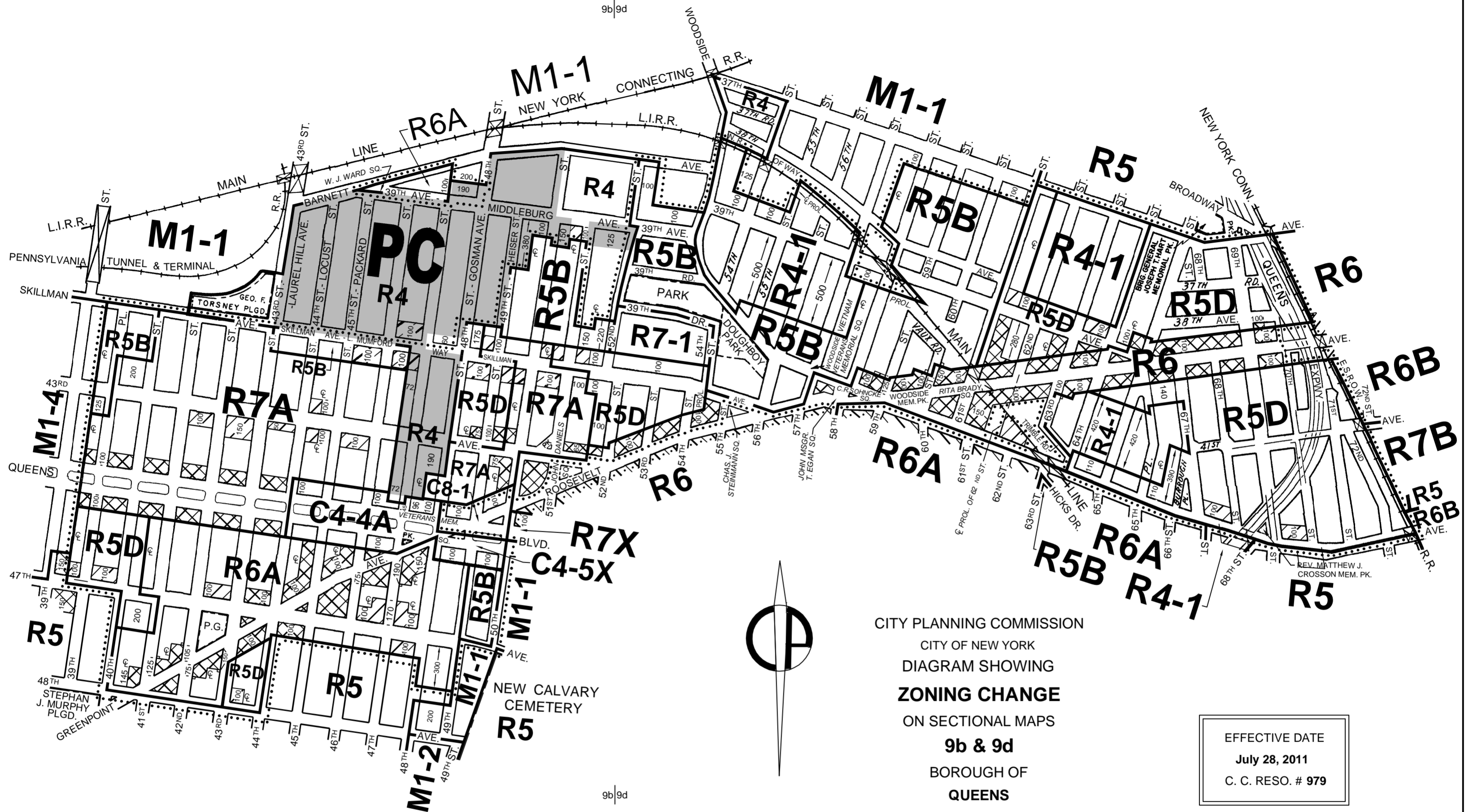

CITY PLANNING COMMISSION  
 CITY OF NEW YORK  
 DIAGRAM SHOWING  
**ZONING CHANGE**  
 ON SECTIONAL MAPS  
**9b & 9d**  
 BOROUGH OF  
**QUEENS**

EFFECTIVE DATE  
**July 28, 2011**  
 C. C. RESO. # 979

NOTE:

- Indicates Zoning District Boundary.
- The areas enclosed by the dotted lines are rezoned by eliminating C1-2 and C2-2 Districts from within existing R5, R6 and R7-1 Districts, by changing R4, R5, R6, R7-1, C4-2, C8-1 and M1-1 Districts to R4, R4-1, R5B, R5D, R6A, R7A, R7X and C4-5X Districts, and by establishing within existing R4 and R6 Districts and proposed R5B, R5D, R6A, R7A and R7X Districts C1-3 and C1-4 Districts.
- Indicates a C1-2 District.
- Indicates a C1-3 District.
- Indicates a C1-4 District.
- Indicates a C2-2 District.
- Indicates a C2-3 District.
- Indicates a C2-4 District.
- Indicates a Special Planned Community Preservation District.

15b  
19a

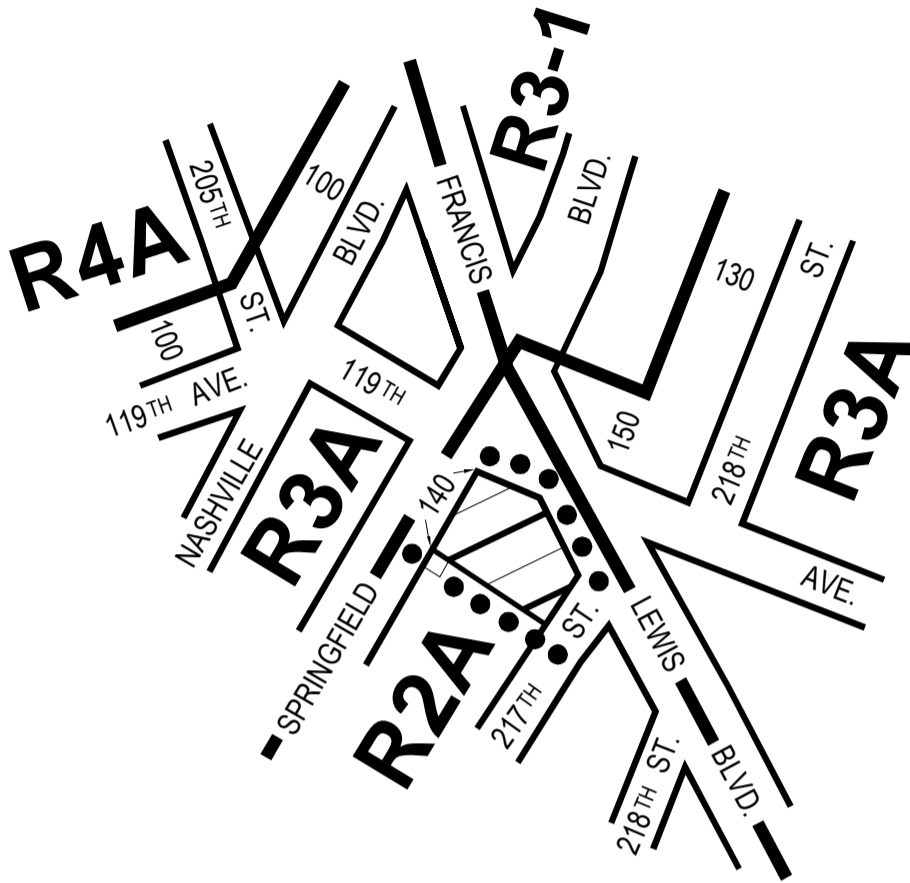

15b  
19a



CITY PLANNING COMMISSION  
 CITY OF NEW YORK  
 DIAGRAM SHOWING  
**ZONING CHANGE**  
 ON SECTIONAL MAP  
**19a**  
 BOROUGH OF  
**QUEENS**

EFFECTIVE DATE  
**May 15, 2012**  
 C. C. RESO. # 1338



- NOTE:
-  Indicates Zoning District Boundary.
  -  The area enclosed by the dotted line is rezoned by establishing a C1-3 District within an existing R2A District.
  -  Indicates a C1-3 District.

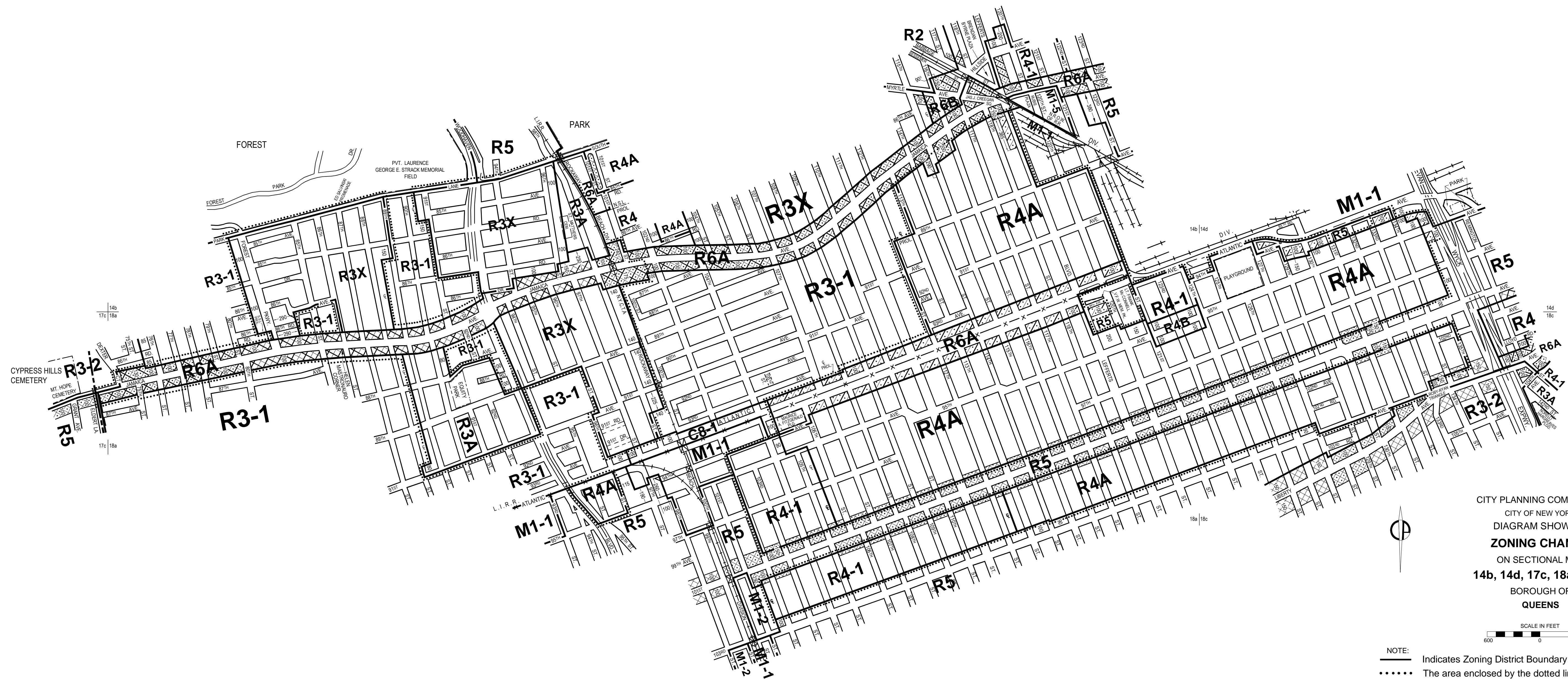

CITY PLANNING COMMISSION  
 CITY OF NEW YORK  
 DIAGRAM SHOWING  
**ZONING CHANGE**  
 ON SECTIONAL MAP  
**14b, 14d, 17c, 18a & 18c**  
 BOROUGH OF  
**QUEENS**

EFFECTIVE DATE  
 July 25, 2012  
 C. C. RESO. # 1465

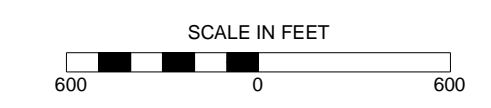
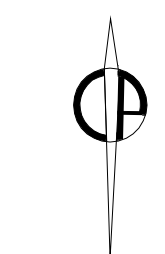

- NOTE:**
- Indicates Zoning District Boundary.
  - ..... The area enclosed by the dotted line is rezoned by eliminating C1-2 and C2-2 Districts from within existing R3-1 and R5 Districts, by changing R3-1, R3-2, R5, C8-1 and M1-1 Districts to R3A, R3X, R4-1, R4A, R4B and R6A Districts, and by establishing C1-4, C2-3 and C2-4 Districts within existing and proposed R4A, R5 and R6A Districts.
  - ▣ Indicates a C1-2 District.
  - ▤ Indicates a C1-4 District.
  - ▥ Indicates a C2-2 District.
  - ▧ Indicates a C2-3 District.
  - ▨ Indicates a C2-4 District.

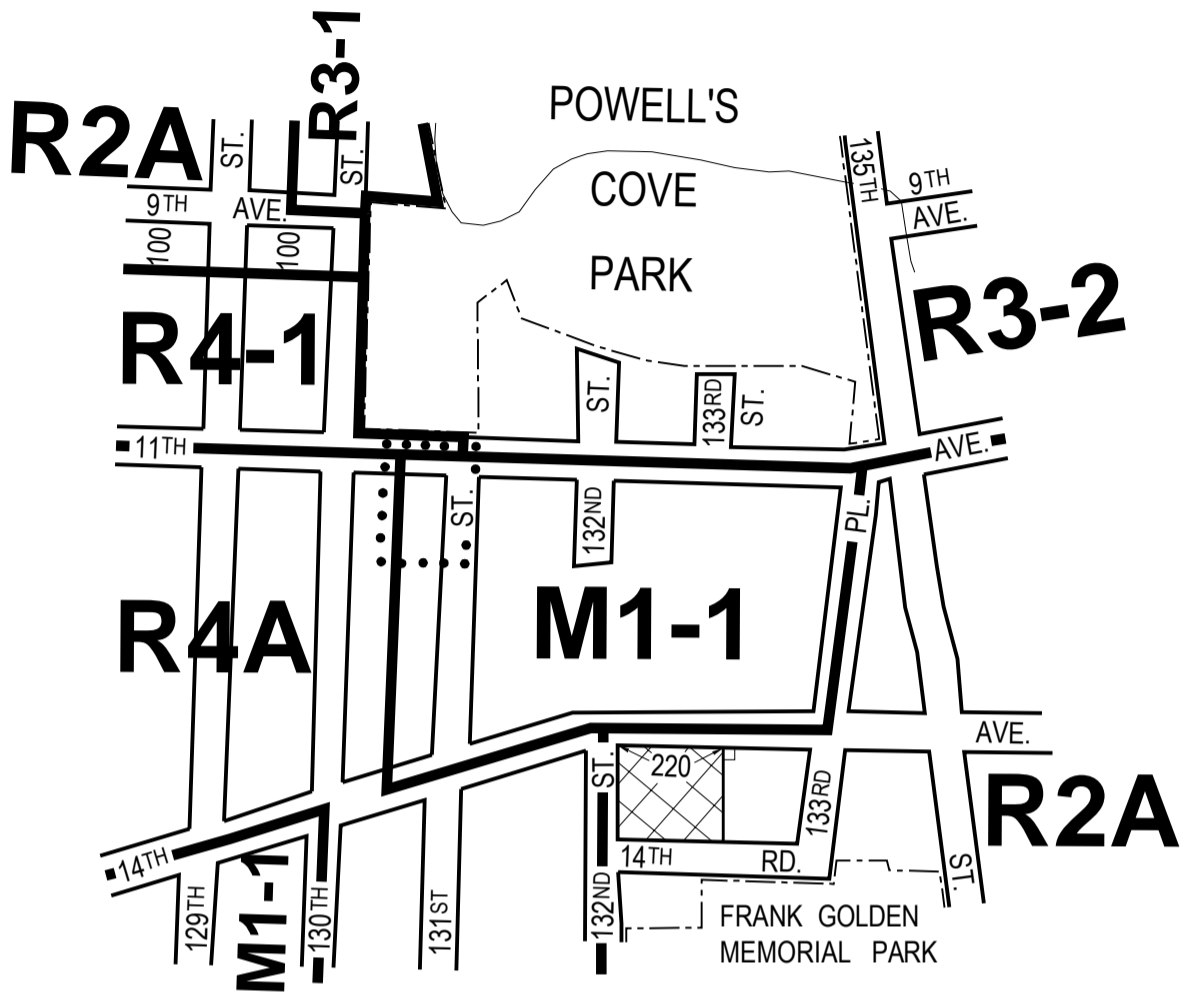



CITY PLANNING COMMISSION  
 CITY OF NEW YORK  
 DIAGRAM SHOWING  
**ZONING CHANGE**  
 ON SECTIONAL MAP  
**7b**  
 BOROUGH OF  
**QUEENS**

EFFECTIVE DATE  
**October 11, 2012**  
 C. C. RESO. # 1544



NOTE:

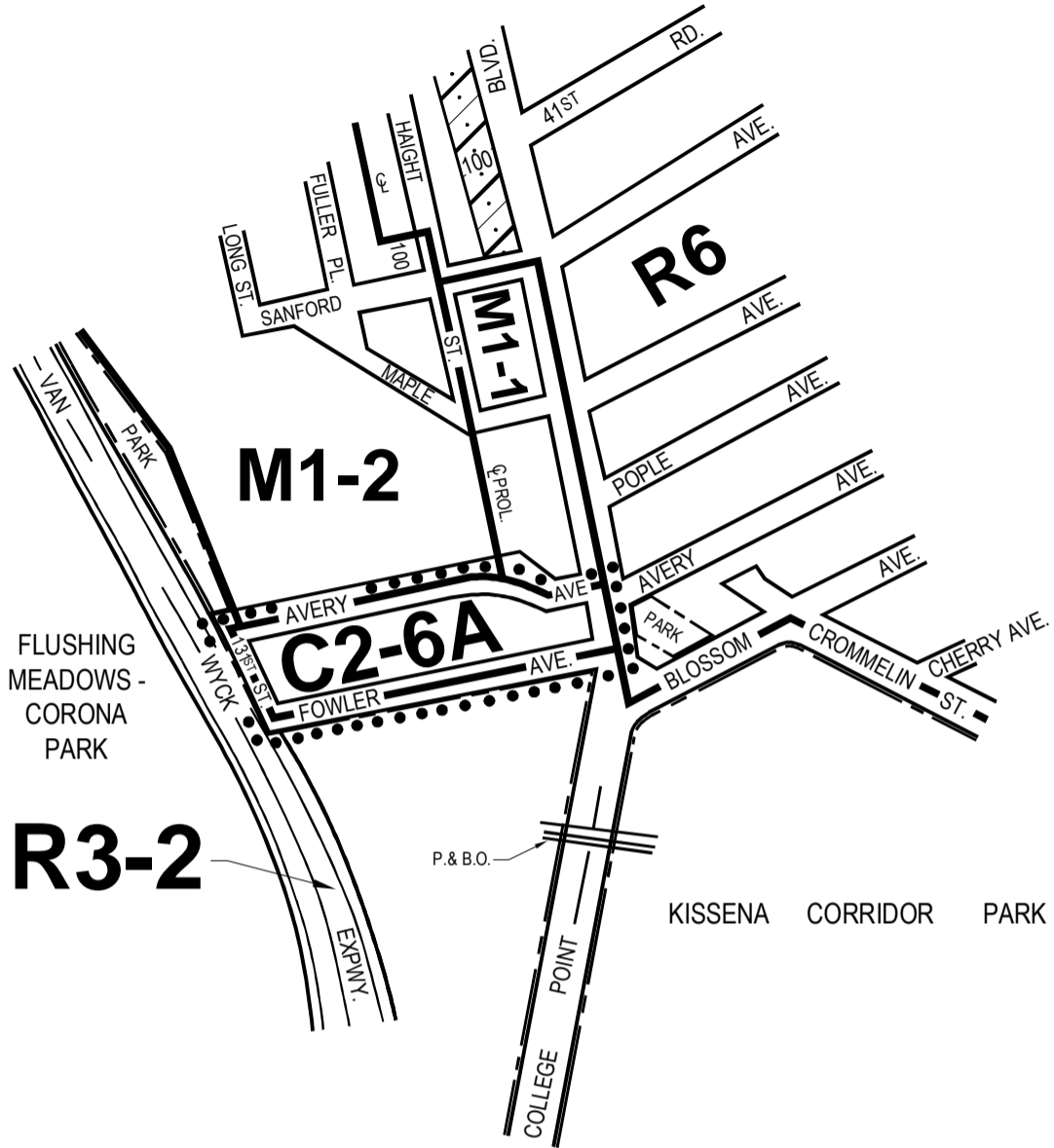

-  Indicates Zoning District Boundary.
-  The area enclosed by the dotted line is rezoned by changing an R4A District to an M1-1 District.
-  Indicates a C1-2 District.



CITY PLANNING COMMISSION  
 CITY OF NEW YORK  
 DIAGRAM SHOWING  
**ZONING CHANGE**  
 ON SECTIONAL MAP  
**10b**  
 BOROUGH OF  
**QUEENS**

EFFECTIVE DATE  
**March 13, 2013**  
 C. C. RESO. # 1684



- NOTE:
-  Indicates Zoning District Boundary.
  -  The area enclosed by the dotted line is rezoned by changing from M1-1 and M1-2 Districts to a C2-6A District.
  -  Indicates a C2-3 District.

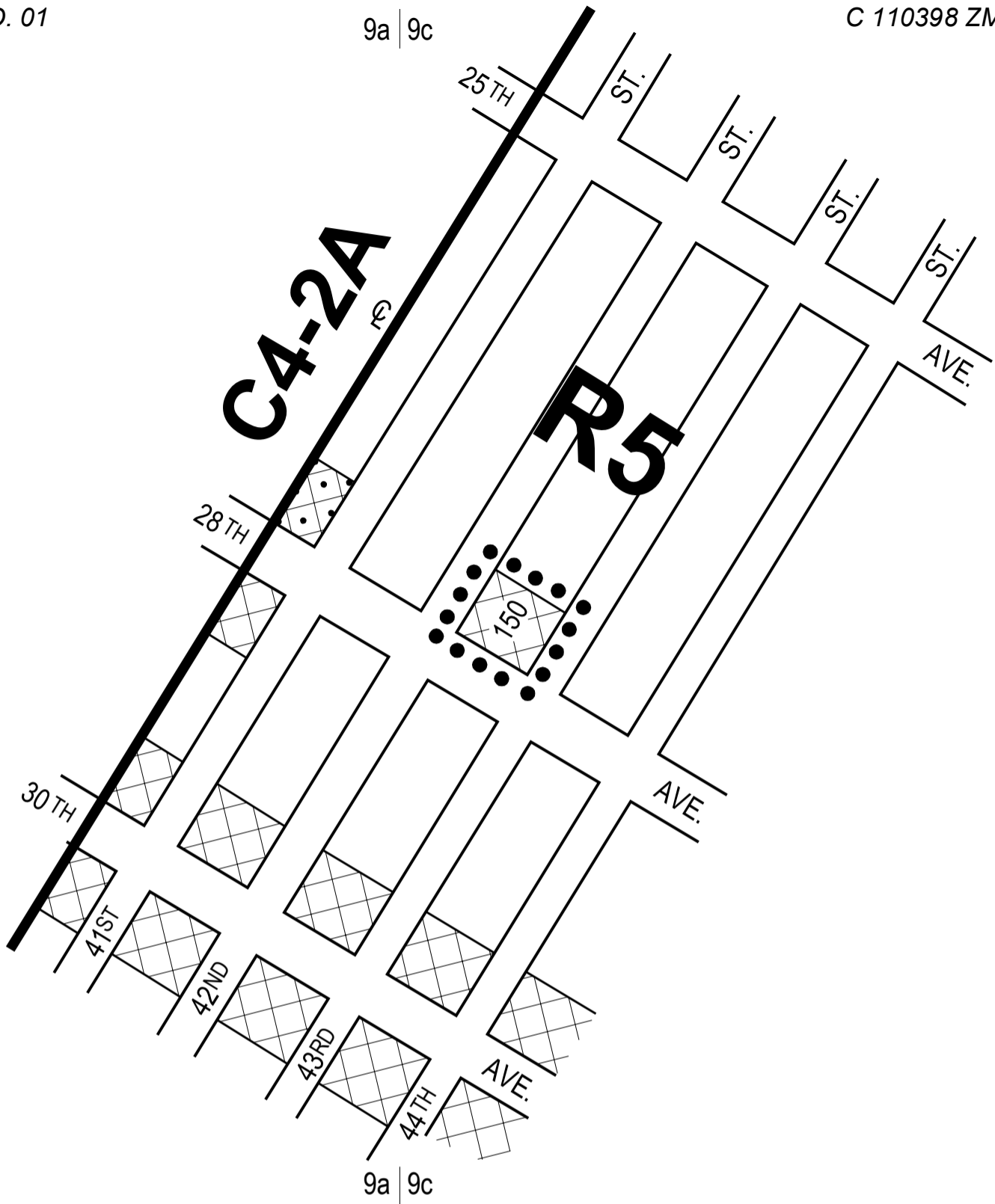

CITY PLANNING COMMISSION

CITY OF NEW YORK

DIAGRAM SHOWING

**ZONING CHANGE**

ON SECTIONAL MAP

**9c**

BOROUGH OF

**QUEENS**

EFFECTIVE DATE

**June 12, 2013**





C. C. RESO. # 1824



SCALE IN FEET



NOTE:

-  Indicates Zoning District Boundary.
-  The area enclosed by the dotted line is changed by establishing a C1-2 District within an existing R5 District.
-  Indicates a C1-2 District.
-  Indicates a C2-2 District.

THIS DIAGRAM IS FOR ILLUSTRATIVE PURPOSES ONLY.



11b | 11d

15a | 15c



CITY PLANNING COMMISSION  
 CITY OF NEW YORK  
 DIAGRAM SHOWING  
**ZONING CHANGE**  
 ON SECTIONAL MAP  
**11b, 11d, 15a & 15c**  
 BOROUGH OF  
**QUEENS**

EFFECTIVE DATE  
**June 24, 2013**  
 C. C. RESO. # 1843



- NOTE:**
- ..... Indicates Zoning District Boundary.
  - ..... The area enclosed by the dotted line is rezoned by eliminating C1-2 and C2-2 Districts from within existing R2, R3-2 and R4 Districts, by changing R2, R3A, R3-1, R3-2, R4, R4-1 and C8-1 Districts to R1-2A, R2, R2A, R3A, R3X, R3-1, R3-2, R4, and R4-1 Districts, and by establishing C1-2 and C2-3 Districts within existing and proposed R3A, R3-2, and R4 Districts.
  - ▨ Indicates a C1-2 District.
  - ▧ Indicates a C1-3 District.
  - ▩ Indicates a C2-2 District.
  - Indicates a C2-3 District.



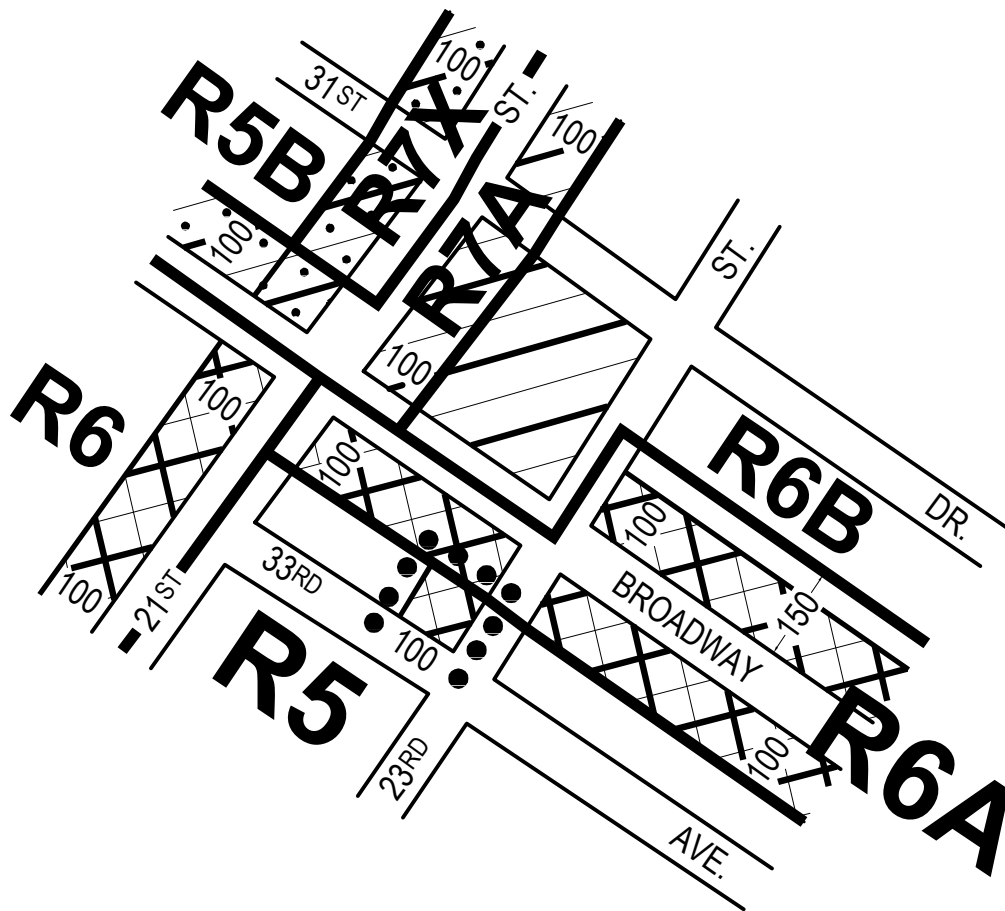



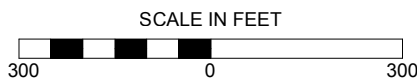

CITY PLANNING COMMISSION  
 CITY OF NEW YORK  
 DIAGRAM SHOWING  
**ZONING CHANGE**  
 ON SECTIONAL MAP  
**9a**  
 BOROUGH OF  
**QUEENS**

EFFECTIVE DATE  
**July 24, 2013**  
 C. C. RESO. # 1884



NOTE:

-  Indicates Zoning District Boundary.
-  The area enclosed by the dotted line is to be rezoned by establishing a C1-4 District within an existing R5 District.
-  Indicates a C1-3 District.
-  Indicates a C1-4 District.
-  Indicates a C2-3 District.

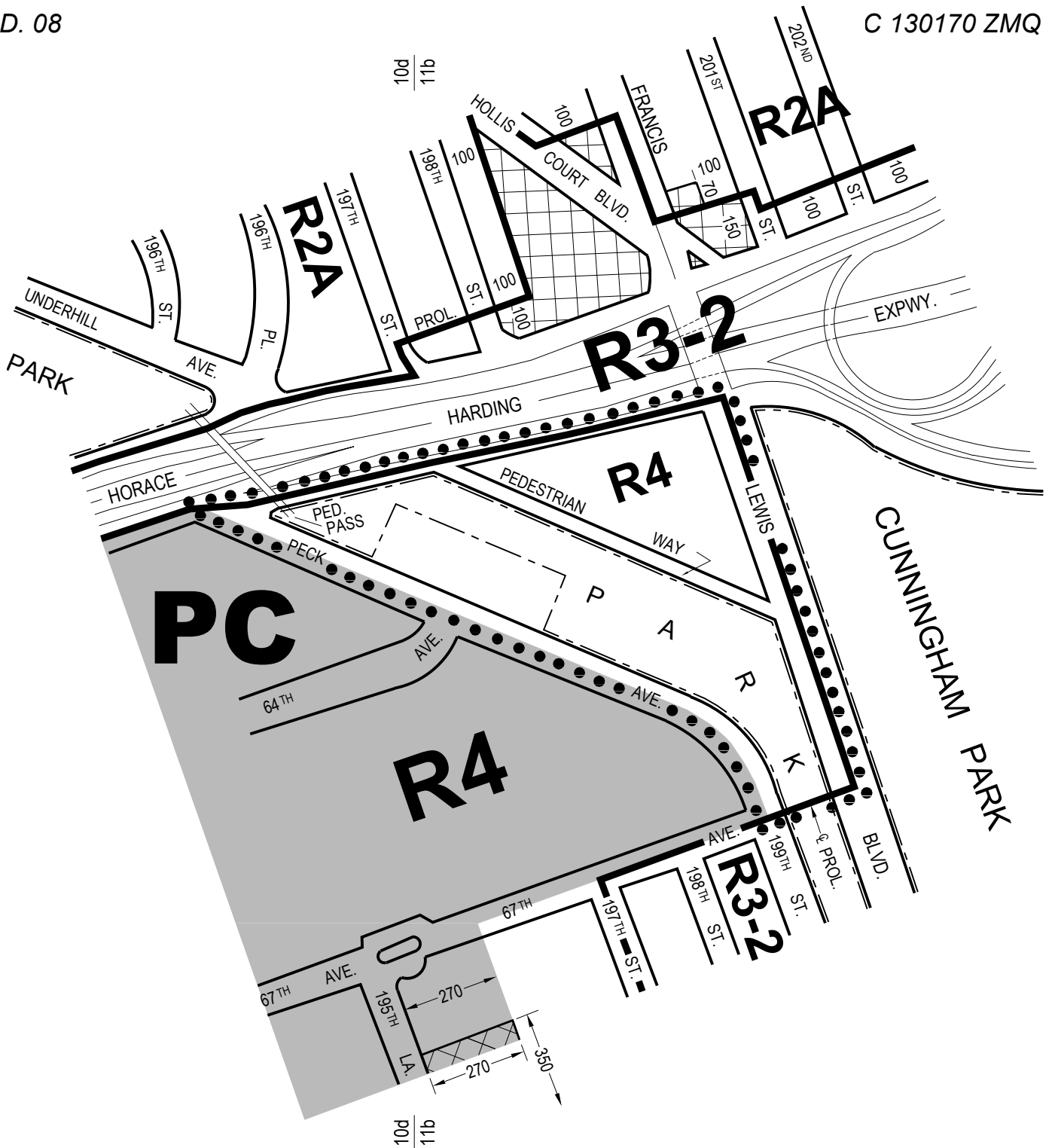



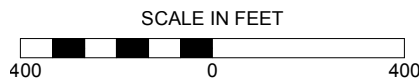

CITY PLANNING COMMISSION  
 CITY OF NEW YORK  
 DIAGRAM SHOWING  
**ZONING CHANGE**  
 ON SECTIONAL MAP  
**10d & 11b**  
 BOROUGH OF  
**QUEENS**

EFFECTIVE DATE  
**August 22, 2013**  
 C. C. RESO. # 1914

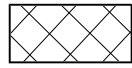

NOTE:

-  Indicates Zoning District Boundary.
-  The area enclosed by the dotted line is rezoned by changing an R3-2 District to an R4 District.
-  Indicates a C1-2 District.
-  Indicates a Special Planned Community Preservation District.

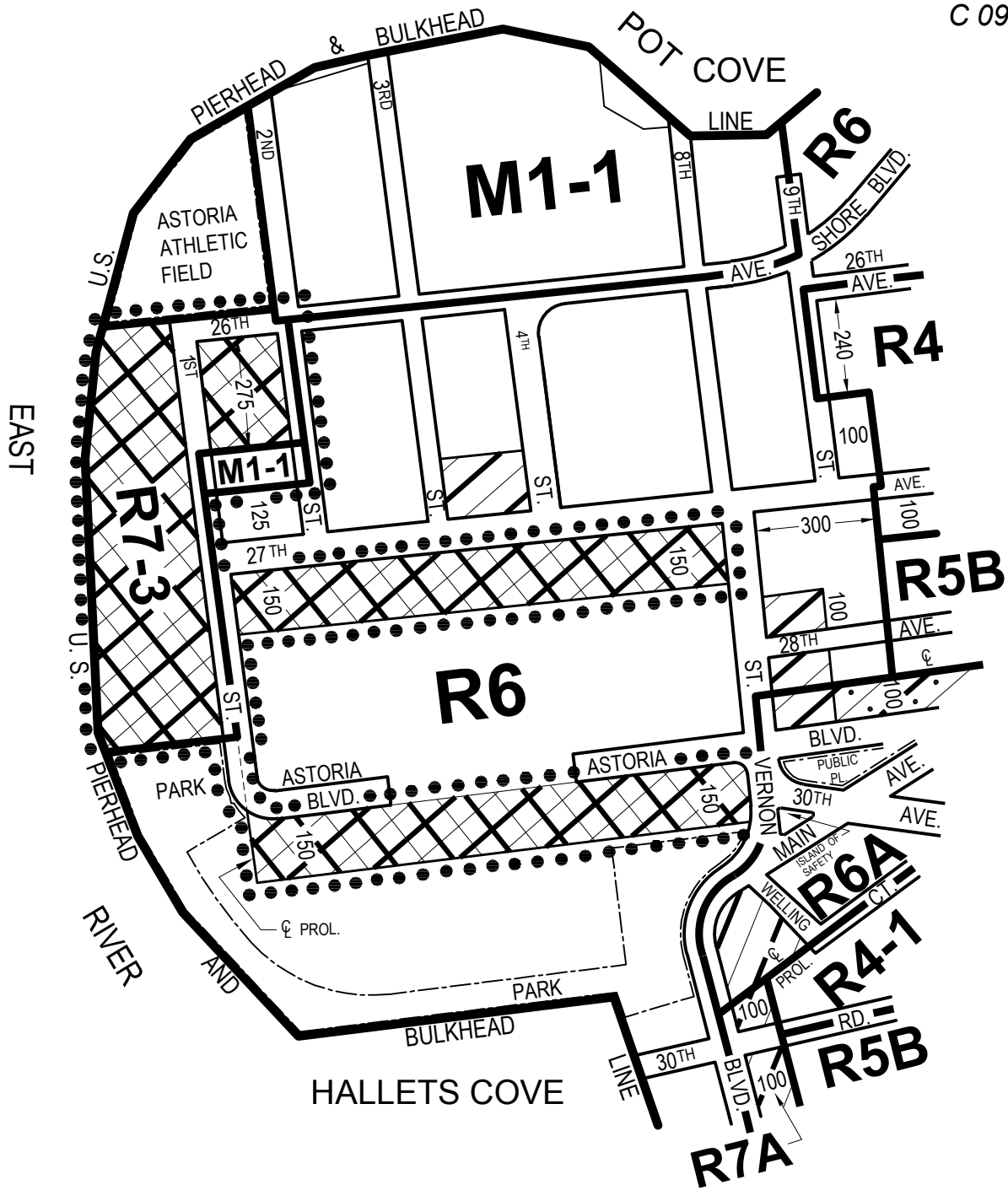



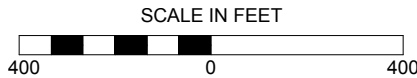

CITY PLANNING COMMISSION  
 CITY OF NEW YORK  
 DIAGRAM SHOWING  
**ZONING CHANGE**  
 ON SECTIONAL MAP  
**9a**  
 BOROUGH OF  
**QUEENS**

EFFECTIVE DATE  
**October 9, 2013**  
 C. C. RESO. # 1978



NOTE:

-  Indicates Zoning District Boundary.
-  The area enclosed by the dotted line is to be rezoned by changing an R6 District to an M1-1 District, and M1-1 District to R6 and R7-3 Districts, and by establishing C1-4 Districts within existing and proposed R6 and R7-3 Districts.
-  Indicates a C1-3 District.
-  Indicates a C1-4 District.
-  Indicates a C2-3 District.

NOTE: THIS DIAGRAM IS FOR ILLUSTRATIVE PURPOSES ONLY.  
 THIS DIAGRAM REFLECTS PROPOSED CHANGES IN THE CITY MAP  
 PURSUANT TO RELATED MAPPING APPLICATION C 130068 MMQ.

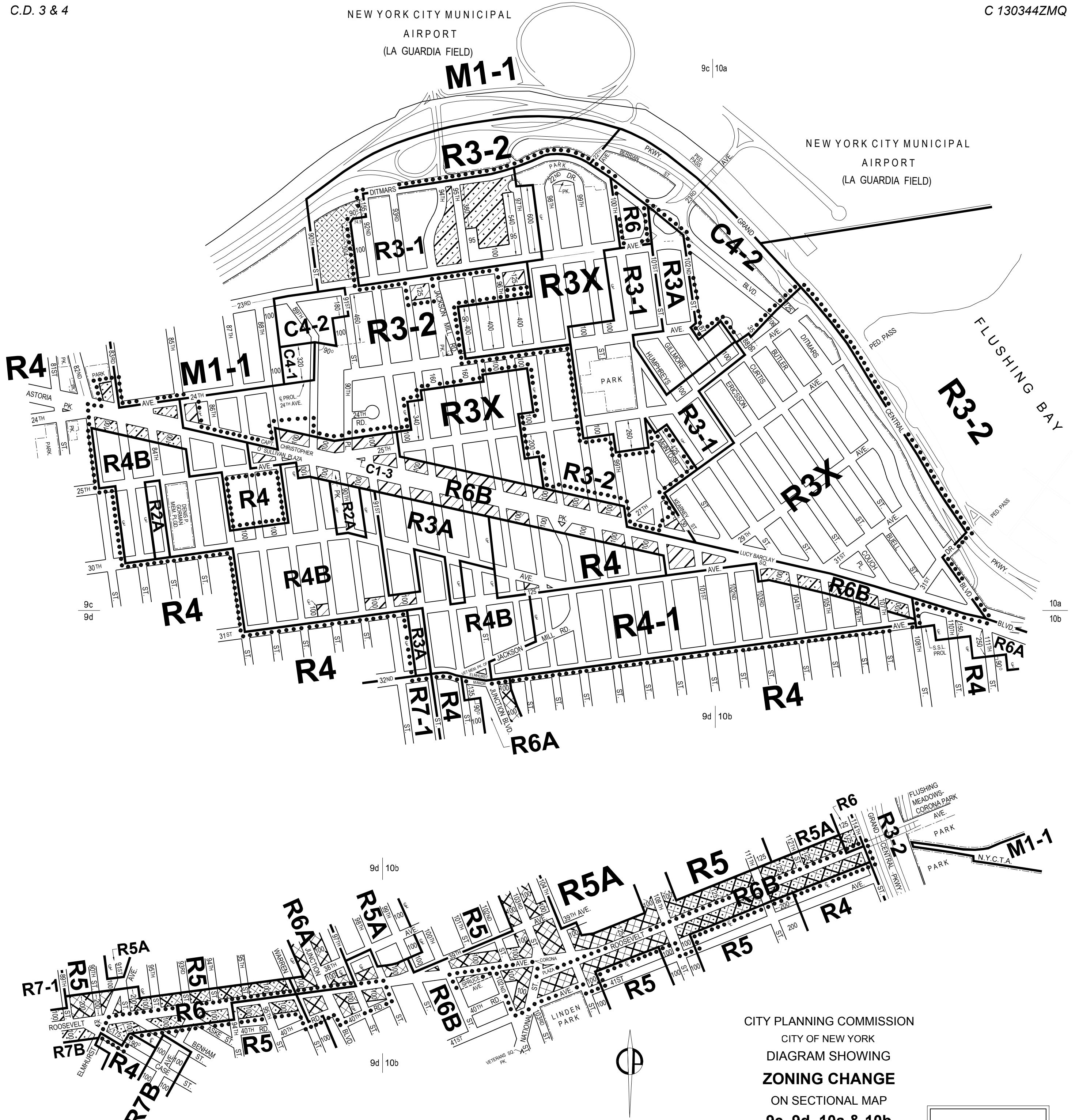

CITY PLANNING COMMISSION  
CITY OF NEW YORK  
DIAGRAM SHOWING  
**ZONING CHANGE**  
ON SECTIONAL MAP  
**9c, 9d, 10a & 10b**  
BOROUGH OF  
**QUEENS**

EFFECTIVE DATE  
**October 30, 2013**  
C. C. RESO. # 2019

- NOTE:
- Indicates Zoning District Boundary.
  - ..... The area enclosed by the dotted line is rezoned by eliminating C1-2, C1-3, and C2-2 Districts from within existing R3-2, R4, R5, R6 and R6B Districts, by changing R3-2 and R4 Districts to R2A, R3A, R3X, R3-1, R4, R4B, R4-1 and R6B Districts, and by establishing C1-3, C1-4, C2-3 and C2-4 Districts within existing and proposed R3-2, R4, R4B, R5, R6 and R6B Districts.

- Indicates a C1-3 District.
- Indicates a C1-4 District.
- Indicates a C2-2 District.
- Indicates a C2-3 District.
- Indicates a C2-4 District.

THIS DIAGRAM IS FOR ILLUSTRATIVE PURPOSES ONLY.



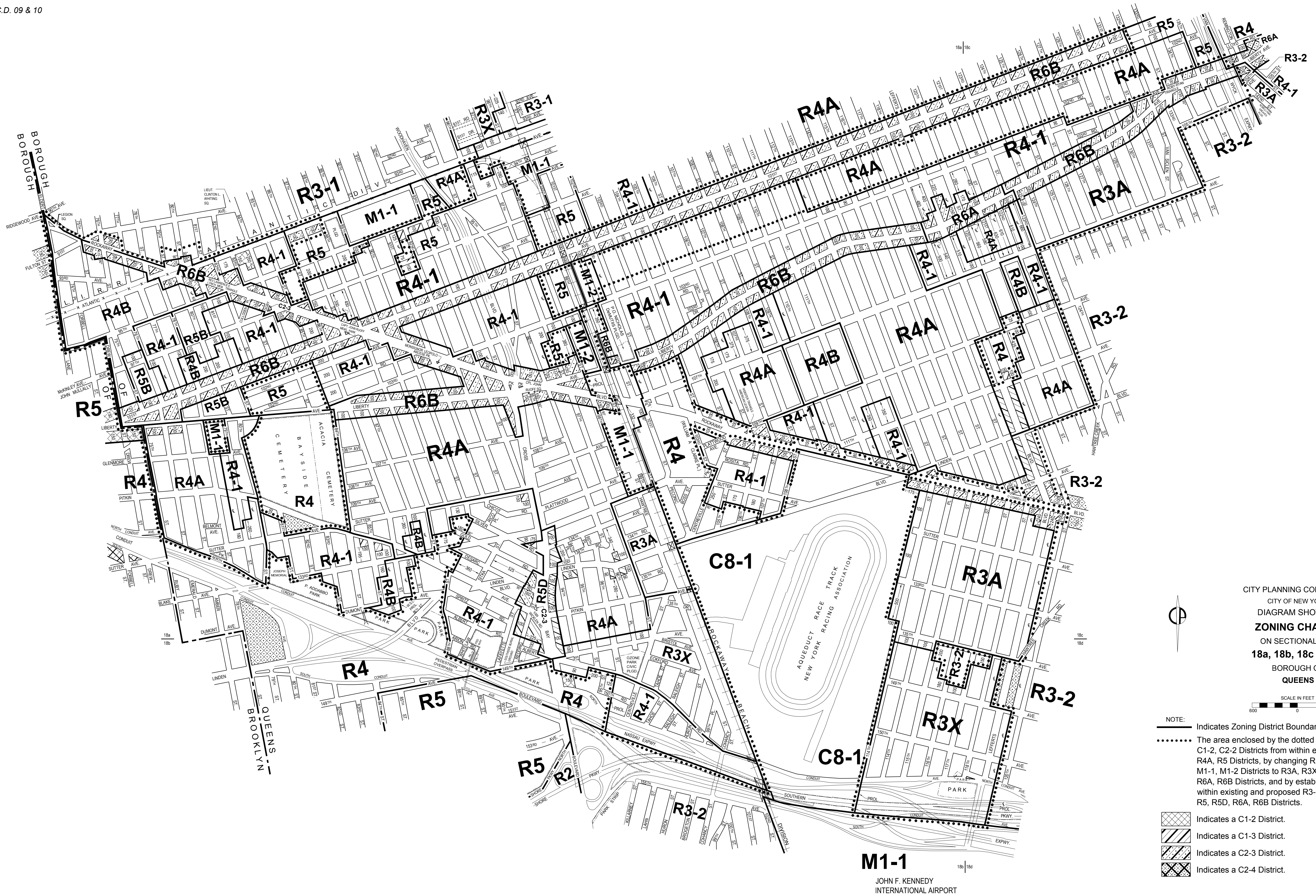

CITY PLANNING COMMISSION  
 CITY OF NEW YORK  
 DIAGRAM SHOWING  
**ZONING CHANGE**  
 ON SECTIONAL MAP  
**18a, 18b, 18c & 18d**  
 BOROUGH OF  
**QUEENS**

EFFECTIVE DATE  
 December 10, 2013  
 C. C. RESO. # 2077

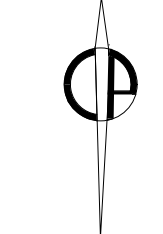

SCALE IN FEET  
 0 600

- NOTE:
- Indicates Zoning District Boundary.
  - ..... The area enclosed by the dotted line is rezoned by eliminating C1-2, C2-2 Districts from within existing R3-1, R3-2, R4, R4-1, R4A, R5 Districts, by changing R3-1, R3-2, R4, R5, C4-2, C8-1, M1-1, M1-2 Districts to R3A, R3X, R4-1, R4A, R4B, R5B, R5D, R6A, R6B Districts, and by establishing C1-3 and C2-3 Districts within existing and proposed R3-1, R3-2, R3A, R4, R4-1, R4A, R5, R5D, R6A, R6B Districts.

- Indicates a C1-2 District.
- Indicates a C1-3 District.
- Indicates a C2-3 District.
- Indicates a C2-4 District.

**M1-1**  
 JOHN F. KENNEDY  
 INTERNATIONAL AIRPORT

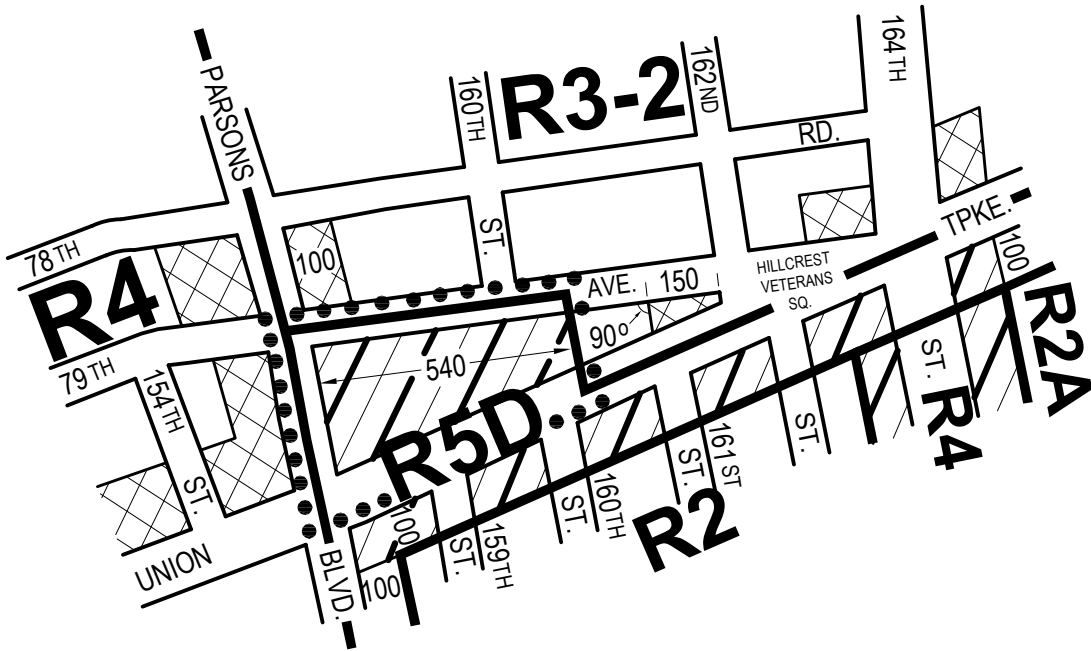



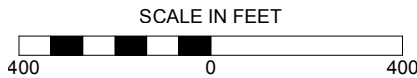

CITY PLANNING COMMISSION  
 CITY OF NEW YORK  
 DIAGRAM SHOWING  
**ZONING CHANGE**  
 ON SECTIONAL MAP  
**14c**  
 BOROUGH OF  
**QUEENS**

EFFECTIVE DATE  
**March 12, 2014**  
 C. C. RESO. # 126

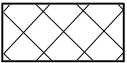

NOTE:

-  Indicates Zoning District Boundary.
-  The area enclosed by the dotted line is rezoned by eliminating a C1-2 District from within an existing R3-2 District, by changing an R3-2 District to an R5D District, and by establishing a C1-3 District within the proposed R5D District.
-  Indicates a C1-2 District.
-  Indicates a C1-3 District.

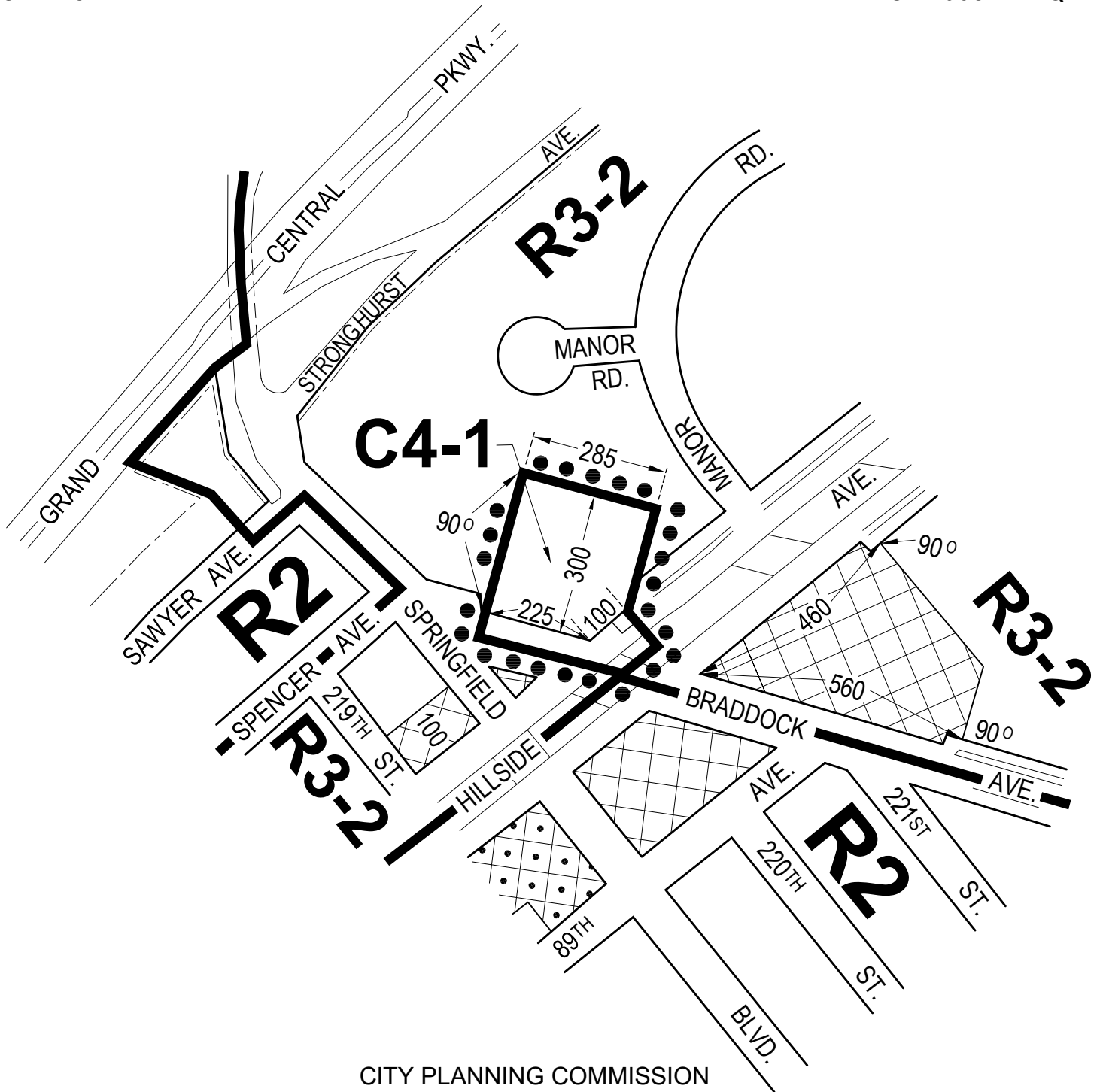



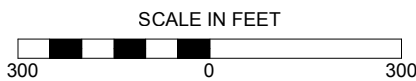

CITY PLANNING COMMISSION  
 CITY OF NEW YORK  
 DIAGRAM SHOWING PROPOSED  
**ZONING CHANGE**  
 ON SECTIONAL MAP  
**15a**  
 BOROUGH OF  
**QUEENS**

EFFECTIVE DATE  
**April 10, 2014**  
 C. C. RESO. # 181

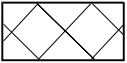

NOTE:

-  Indicates Zoning District Boundary.
-  The area enclosed by the dotted line is rezoned by eliminating a C2-2 District from within an existing R3-2 District, and by changing an R3-2 District to a C4-1 District.
-  Indicates a C1-2 District.
-  Indicates a C2-2 District.

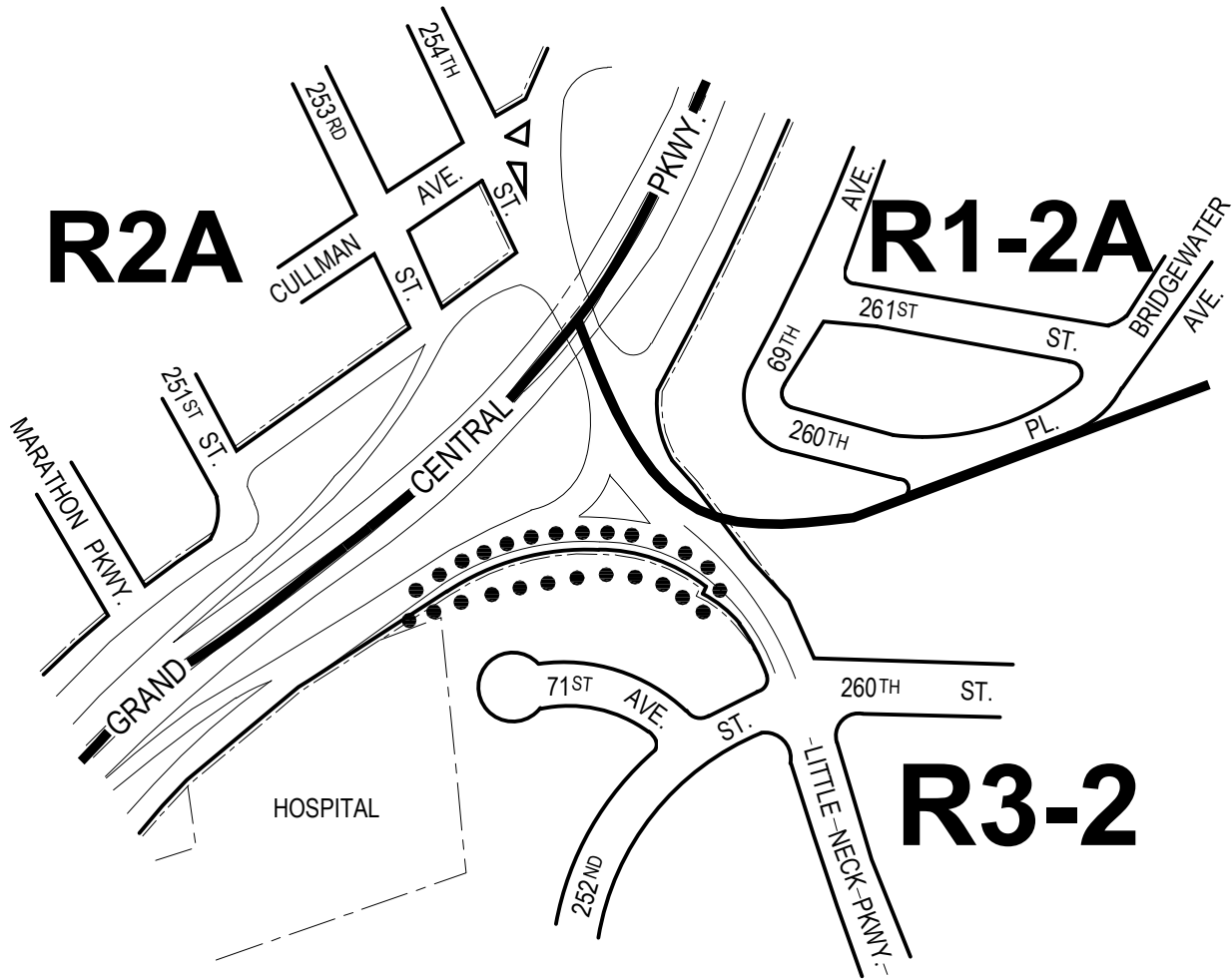

CITY PLANNING COMMISSION  
 CITY OF NEW YORK  
 DIAGRAM SHOWING  
**ZONING CHANGE**  
 ON SECTIONAL MAP  
**11d**  
 BOROUGH OF  
**QUEENS**

EFFECTIVE DATE  
**May 29, 2014**  
 C. C. RESO. # 272

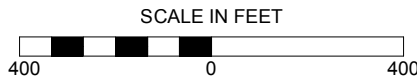

NOTE:

- Indicates Zoning District Boundary.
- The area enclosed by the dotted line is rezoned by establishing within a former Park an R3-2 District.

NOTE: THIS DIAGRAM IS FOR ILLUSTRATIVE PURPOSES ONLY.  
 THIS DIAGRAM REFLECTS PROPOSED CHANGES IN THE CITY MAP  
 PURSUANT TO RELATED MAPPING APPLICATION C 130314 MMQ



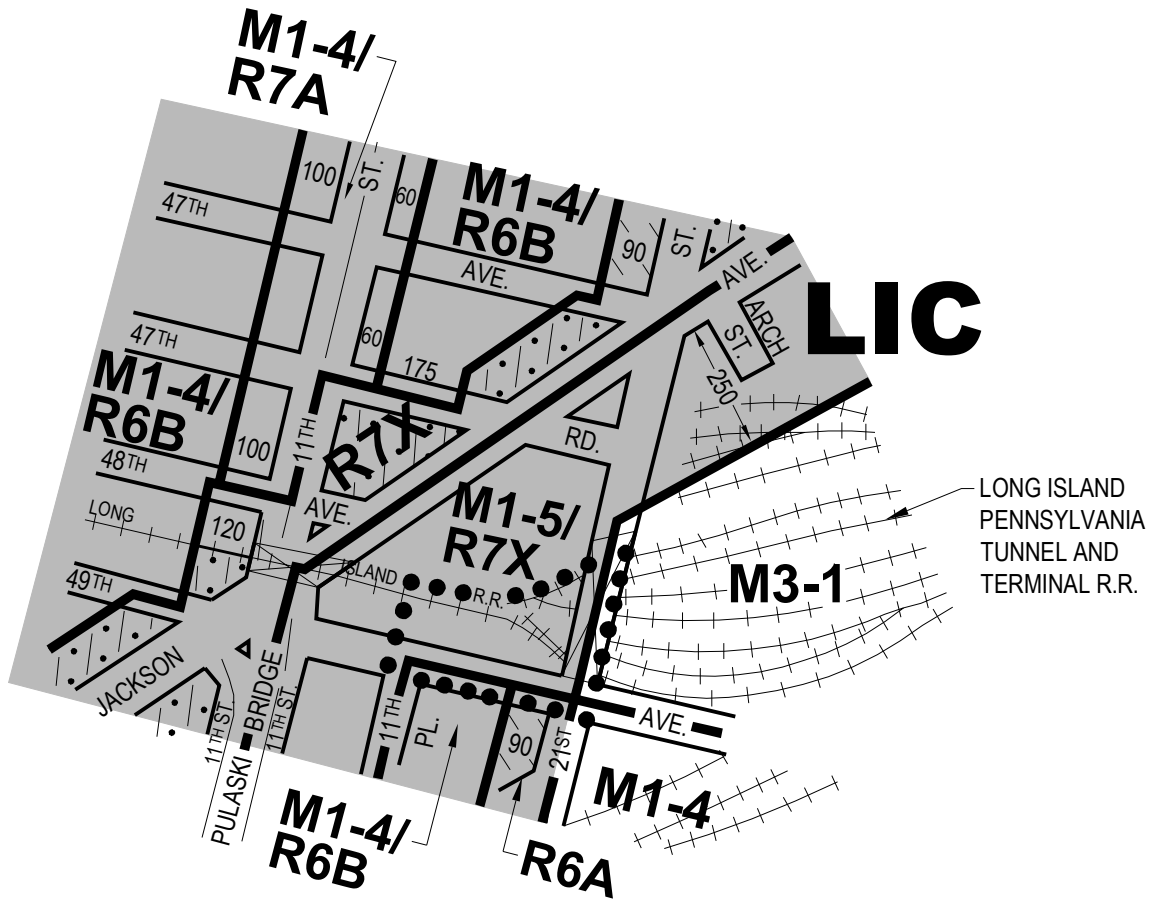



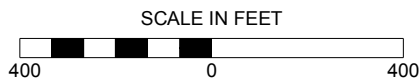

CITY PLANNING COMMISSION  
 CITY OF NEW YORK  
 DIAGRAM SHOWING  
**ZONING CHANGE**  
 ON SECTIONAL MAP  
**9b**  
 BOROUGH OF  
**QUEENS**

EFFECTIVE DATE  
**July 24, 2014**  
 C. C. RESO. # 366

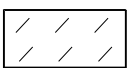
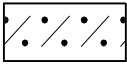

NOTE:

-  Indicates Zoning District Boundary.
-  The area enclosed by the dotted line is rezoned by changing an M1-4 District to an M1-5/R7X District and by establishing a Special Long Island City District (**LIC**).
-  Indicates a C1-5 District.
-  Indicates a C2-5 District.
-  Indicates a Special Long Island City Mixed Use District.

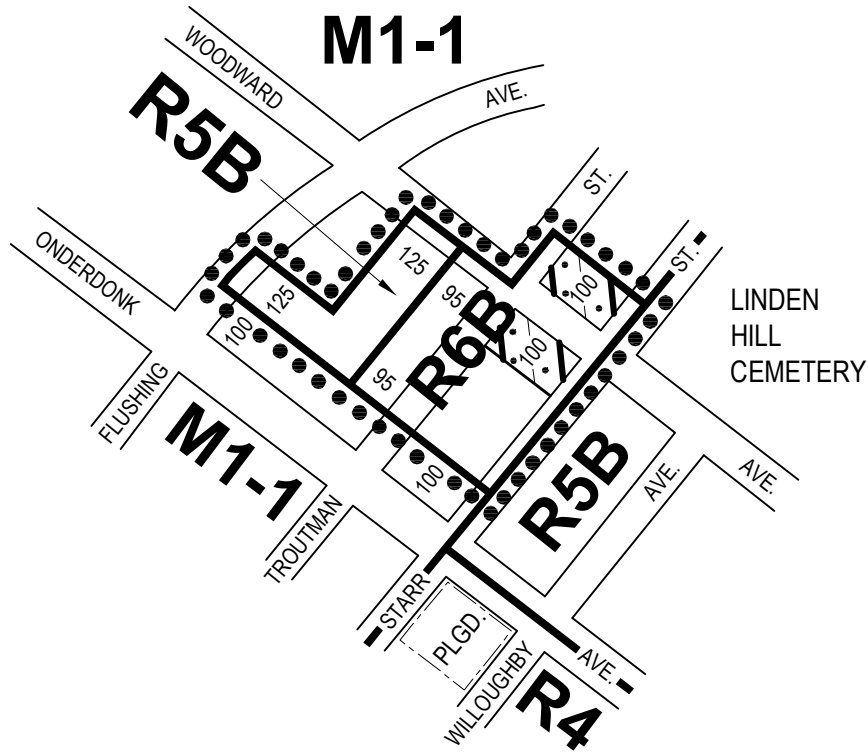

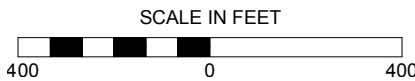

CITY PLANNING COMMISSION  
 CITY OF NEW YORK  
 DIAGRAM SHOWING  
**ZONING CHANGE**  
 ON SECTIONAL MAP  
**13b**  
 BOROUGH OF  
**QUEENS**

EFFECTIVE DATE  
**August 21, 2014**  
 C. C. RESO. # 400



NOTE:

-  Indicates Zoning District Boundary.
-  The area enclosed by the dotted line is rezoned by changing an M1-1 District to R5B and R6B Districts and by establishing C2-3 Districts within the proposed R6B District.
-  Indicates a C2-3 District.

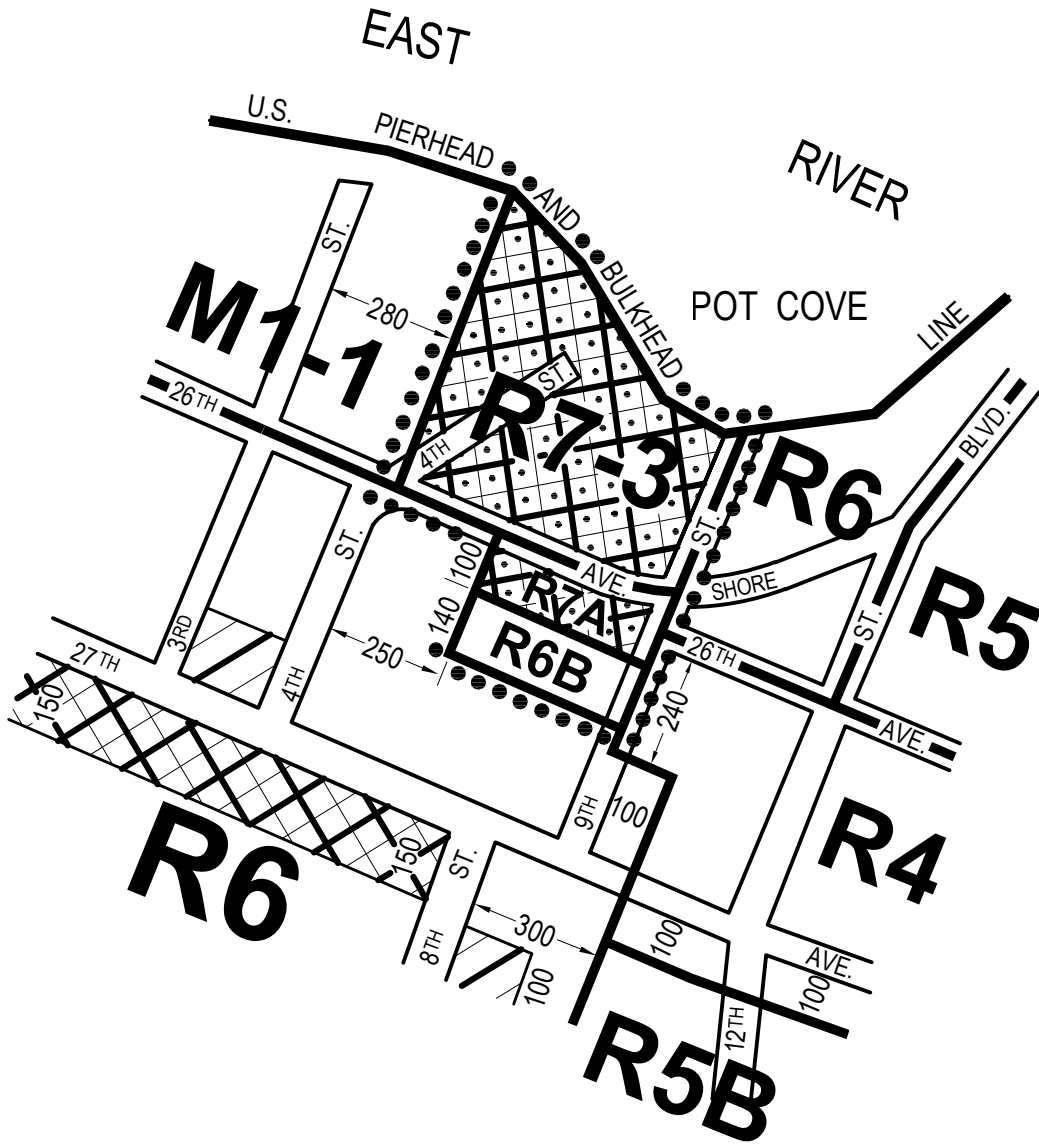



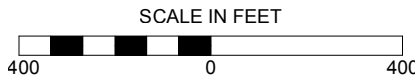

CITY PLANNING COMMISSION  
 CITY OF NEW YORK  
 DIAGRAM SHOWING  
**ZONING CHANGE**  
 ON SECTIONAL MAP  
**9a**  
 BOROUGH OF  
**QUEENS**

EFFECTIVE DATE  
**November 25, 2014**  
 C. C. RESO. # 495



NOTE:

-  Indicates Zoning District Boundary.
-  The area enclosed by the dotted line is to be rezoned by changing an M1-1 District to an R7-3 District, by changing an R6 District to R6B and R7A Districts and by establishing a C2-4 District within proposed R7A and R7-3 Districts.
-  Indicates a C1-3 District.
-  Indicates a C1-4 District.
-  Indicates a C2-4 District.

NOTE: THIS DIAGRAM IS FOR ILLUSTRATIVE PURPOSES ONLY.  
 THIS DIAGRAM REFLECTS PROPOSED CHANGES IN THE CITY MAP  
 PURSUANT TO RELATED MAPPING APPLICATION C 130384 MMQ

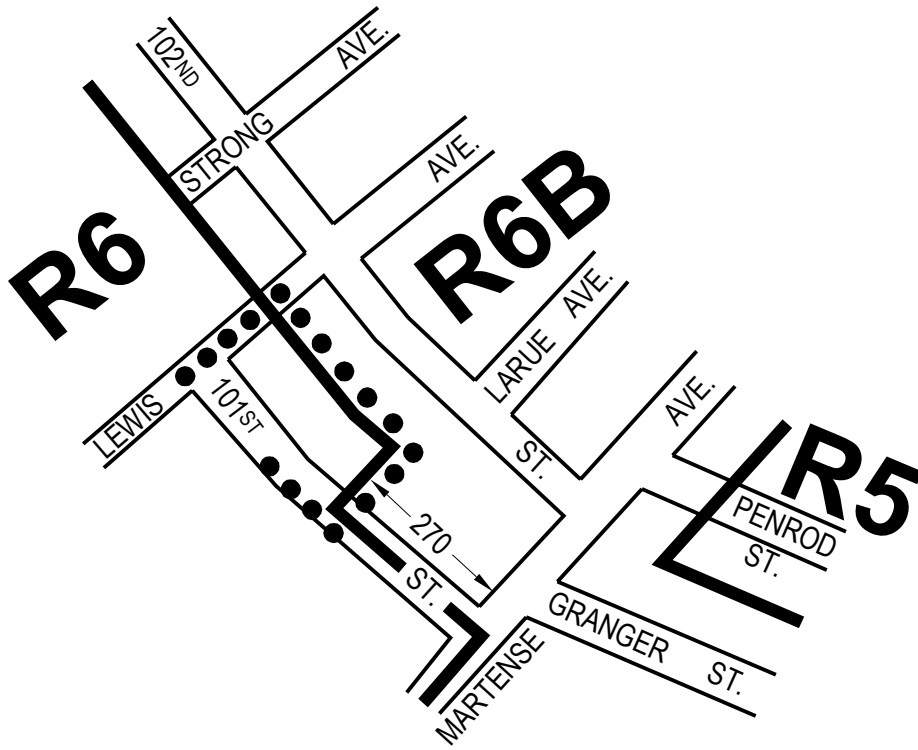

CITY PLANNING COMMISSION  
 CITY OF NEW YORK  
 DIAGRAM SHOWING  
**ZONING CHANGE**  
 ON SECTIONAL MAP  
**10b**  
 BOROUGH OF  
**QUEENS**

EFFECTIVE DATE  
**March 11, 2015**  
 C. C. RESO. # **633**

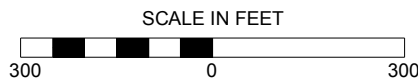

NOTE:

- Indicates Zoning District Boundary.
- The area enclosed by the dotted line is rezoned by changing from an R6B District to an R6 District.

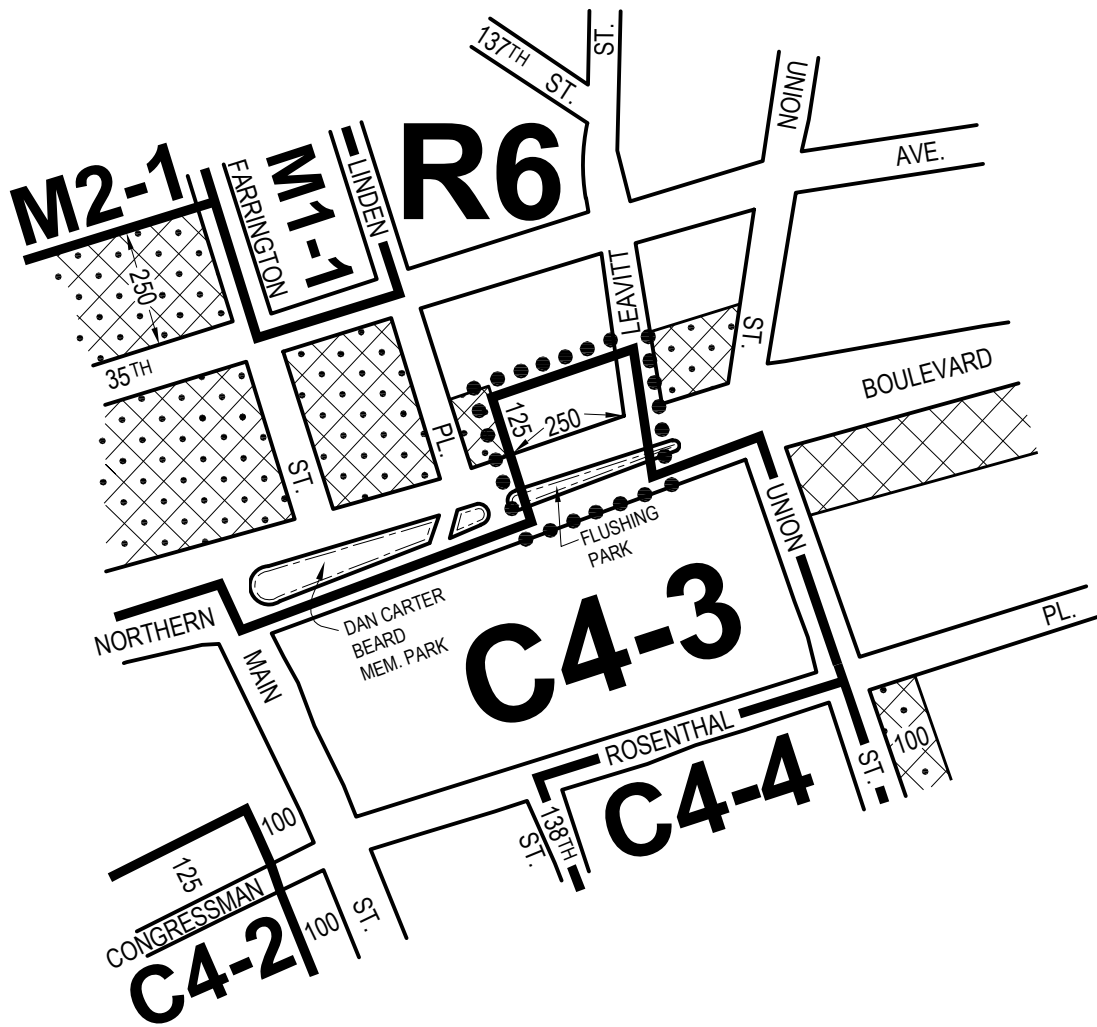



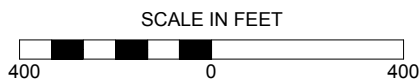

CITY PLANNING COMMISSION  
 CITY OF NEW YORK  
 DIAGRAM SHOWING  
**ZONING CHANGE**  
 ON SECTIONAL MAP  
**10a**  
 BOROUGH OF  
**QUEENS**

EFFECTIVE DATE  
**March 31, 2015**  
 C. C. RESO. # 645

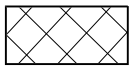

NOTE:

-  Indicates Zoning District Boundary.
-  The area enclosed by the dotted line is rezoned by eliminating a C2-2 District from within an R6 District, and changing an R6 District to a C4-3 District.
-  Indicates a C1-2 District.
-  Indicates a C2-2 District.

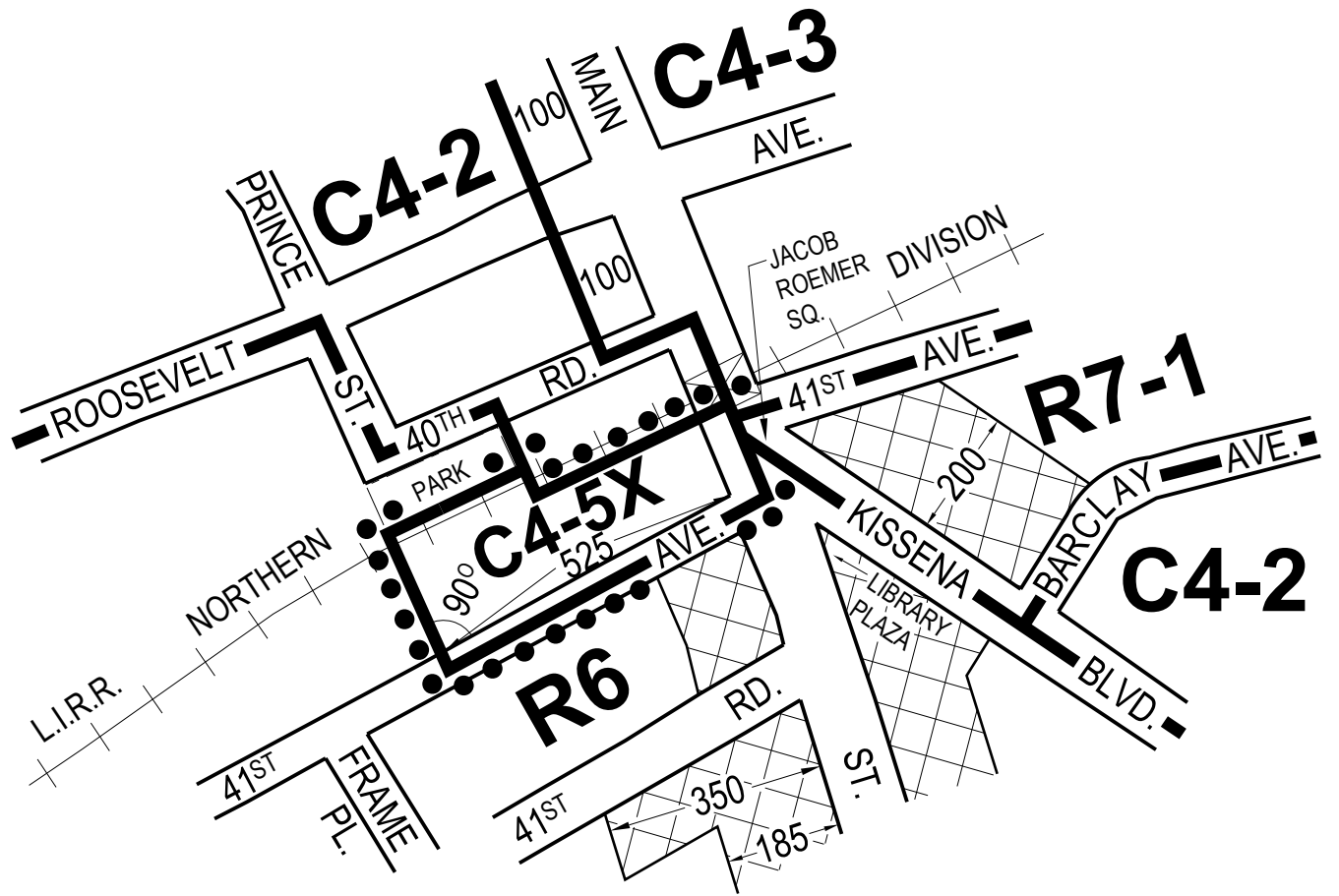

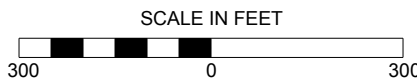

CITY PLANNING COMMISSION  
 CITY OF NEW YORK  
 DIAGRAM SHOWING  
**ZONING CHANGE**  
 ON SECTIONAL MAP  
**10b**  
 BOROUGH OF  
**QUEENS**

EFFECTIVE DATE  
**June 21, 2016**  
 C. C. RESO. # 1155



NOTE:

-  Indicates Zoning District Boundary.
-  The area enclosed by the dotted line is rezoned by changing an existing C4-2 District to a C4-5X District.
-  Indicates a C1-2 District.

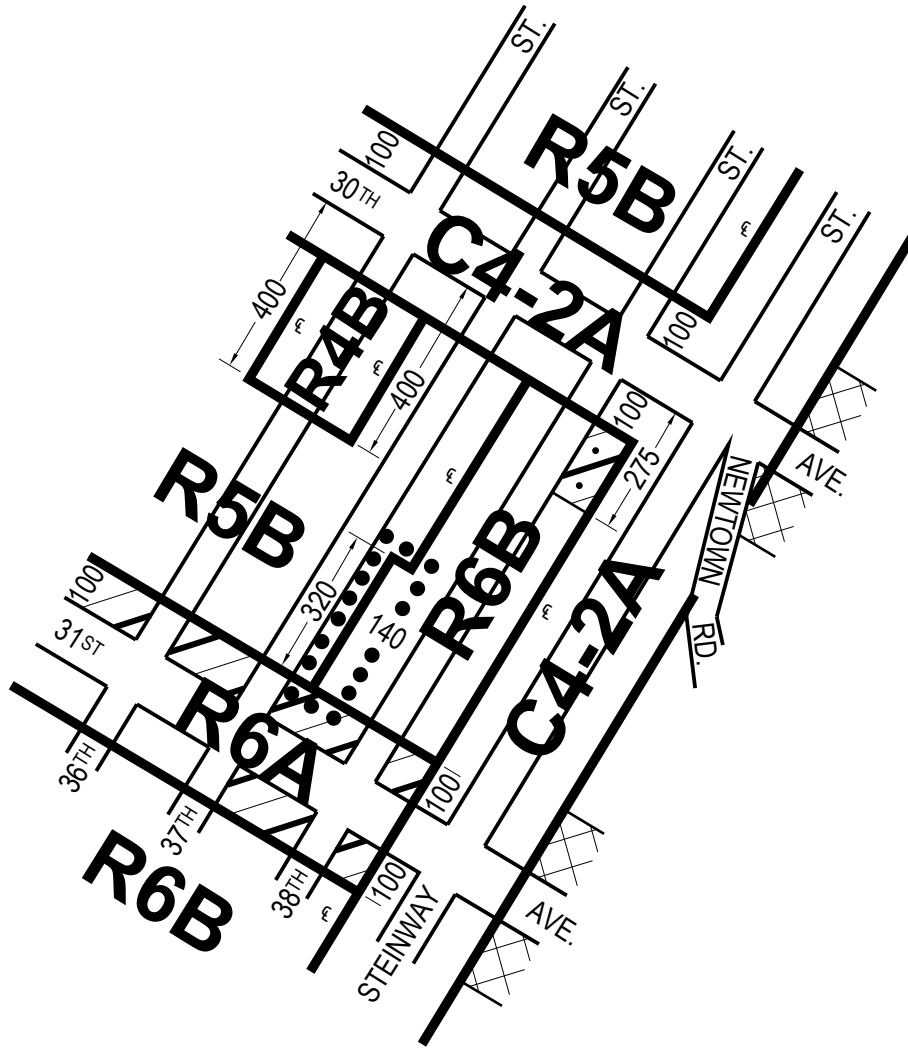



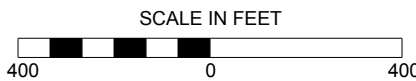

CITY PLANNING COMMISSION  
 CITY OF NEW YORK  
 DIAGRAM SHOWING PROPOSED  
**ZONING CHANGE**  
 ON SECTIONAL MAP  
**9a**  
 BOROUGH OF  
**QUEENS**

EFFECTIVE DATE  
**September 14, 2016**  
 C. C. RESO. # 1203



**NOTE:**

-  Indicates Zoning District Boundary.
-  The area enclosed by the dotted line is rezoned by changing an existing R5B District to an R6B District.
-  Indicates a C1-2 District.
-  Indicates a C1-3 District.
-  Indicates a C2-3 District.

30a  
30b

30a  
30b

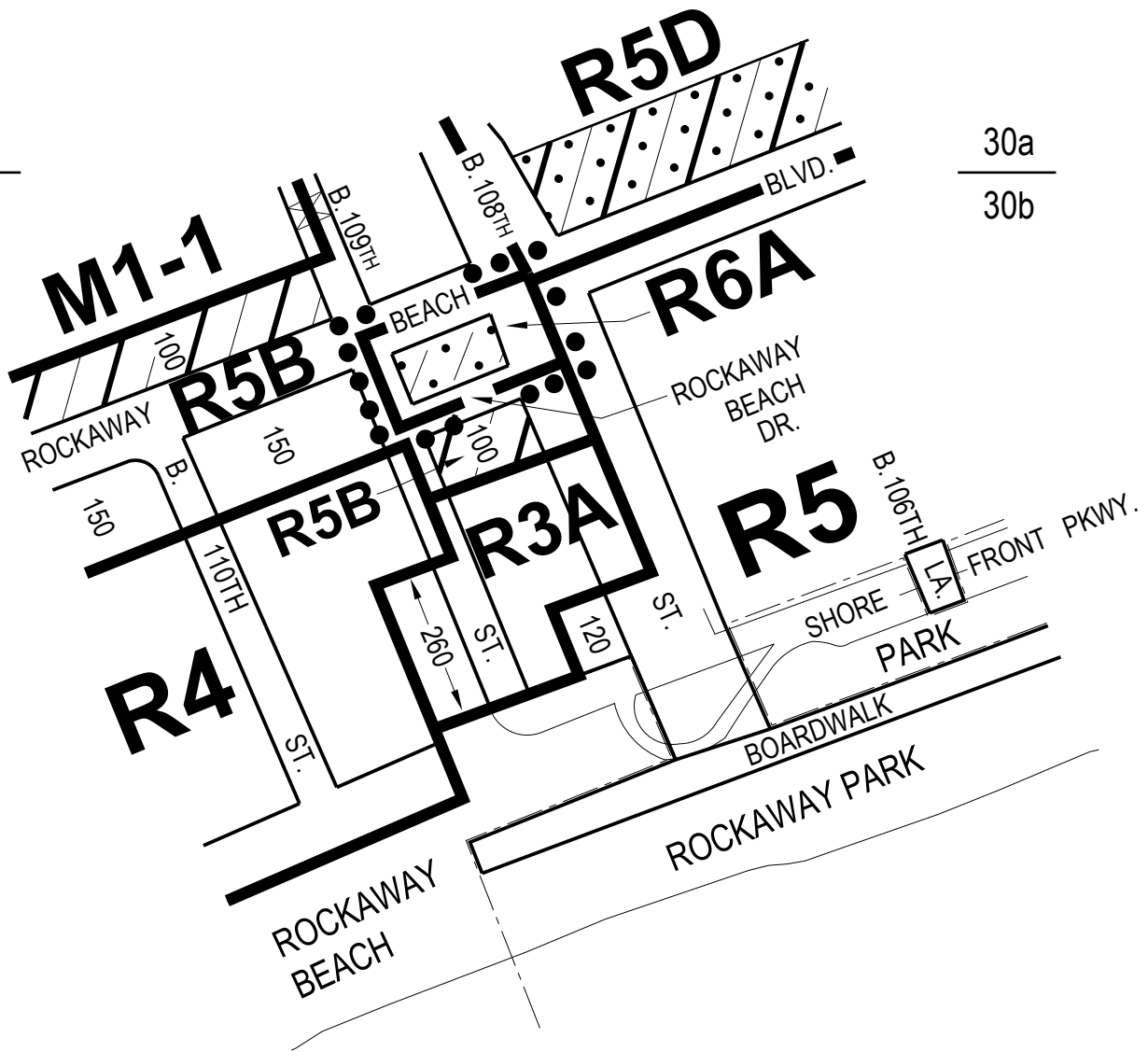

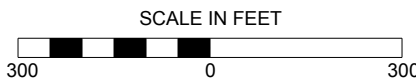

CITY PLANNING COMMISSION  
 CITY OF NEW YORK  
 DIAGRAM SHOWING PROPOSED  
**ZONING CHANGE**  
 ON SECTIONAL MAP  
**30b**  
 BOROUGH OF  
**QUEENS**

EFFECTIVE DATE  
**October 13, 2016**  
 C. C. RESO. # 1254

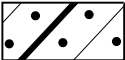
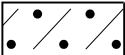

NOTE:

-  Indicates Zoning District Boundary.
-  The area enclosed by the dotted line is proposed to be rezoned by eliminating a C1-3 District from within an existing R5B District, changing an R5B District to an R6A District, and by establishing a C2-5 District within the proposed R6A District.
-  Indicates a C1-3 District.
-  Indicates a C2-3 District.
-  Indicates a C2-5 District.



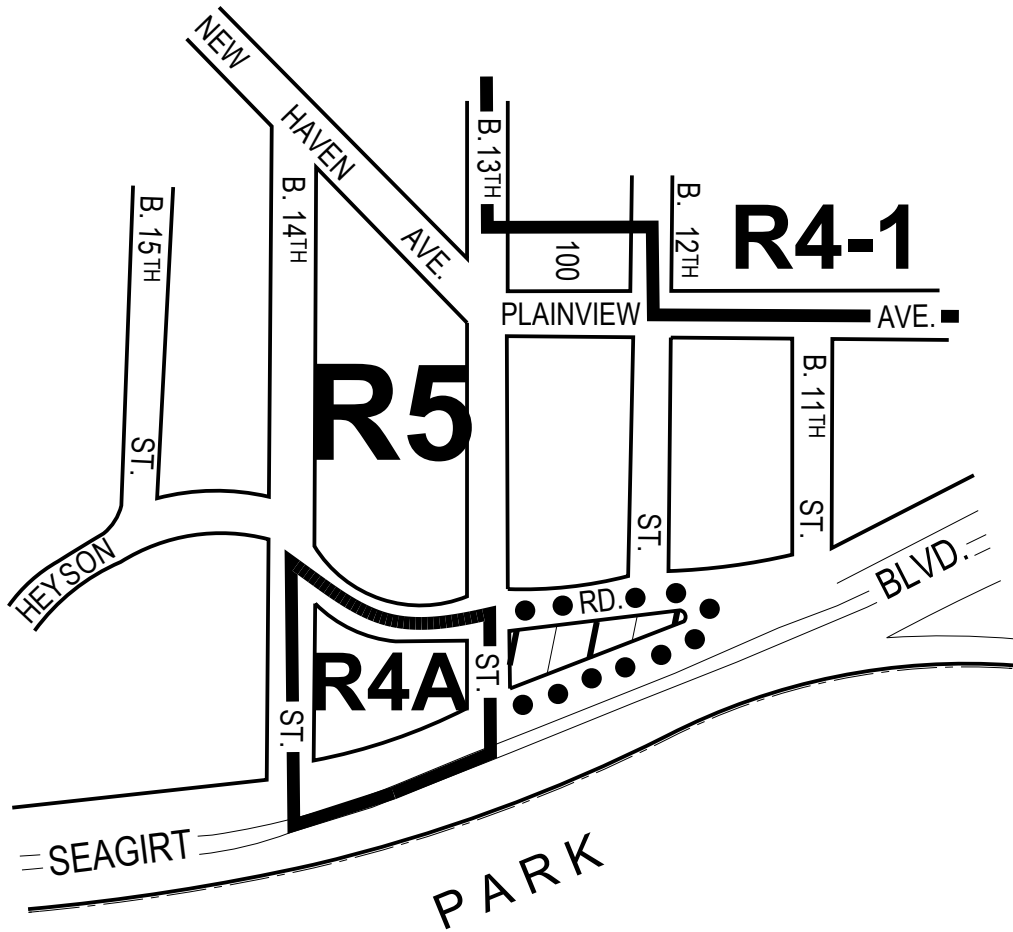

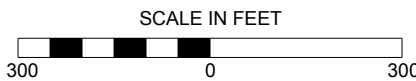

CITY PLANNING COMMISSION  
 CITY OF NEW YORK  
 DIAGRAM SHOWING PROPOSED  
**ZONING CHANGE**  
 ON SECTIONAL MAP  
**31a**  
 BOROUGH OF  
**QUEENS**

EFFECTIVE DATE  
**October 13, 2016**  
 C. C. RESO. # 1257



NOTE:

-  Indicates Zoning District Boundary.
-  The area enclosed by the dotted line is proposed to be rezoned by establishing within an existing R5 District a C1-3 District.
-  Indicates a C1-3 District.

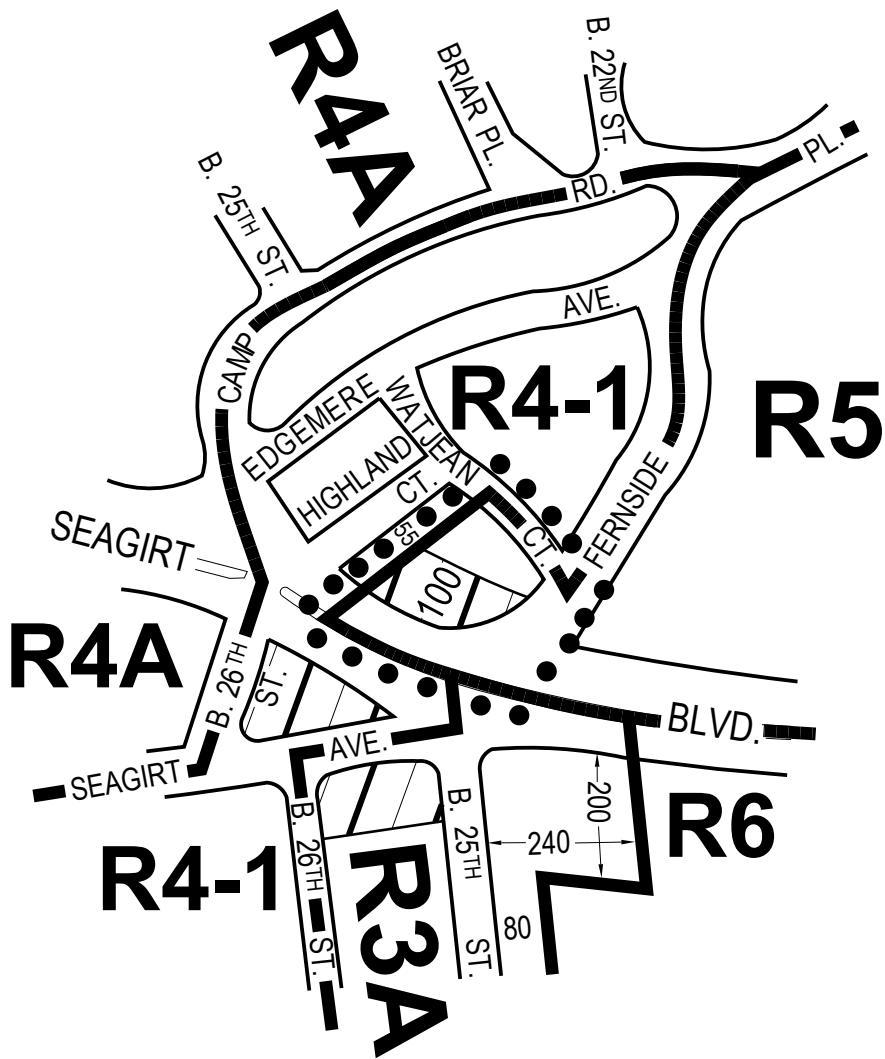

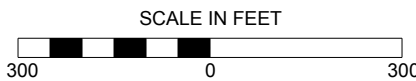

CITY PLANNING COMMISSION  
 CITY OF NEW YORK  
 DIAGRAM SHOWING PROPOSED  
**ZONING CHANGE**  
 ON SECTIONAL MAP  
**31a**  
 BOROUGH OF  
**QUEENS**

EFFECTIVE DATE  
**October 13, 2016**  
 C. C. RESO. # 1258



NOTE:

-  Indicates Zoning District Boundary.
-  The area enclosed by the dotted line is proposed to be rezoned by changing an R4-1 District to an R5 District and by establishing a C1-3 District within the proposed R5 District.
-  Indicates a C1-3 District.

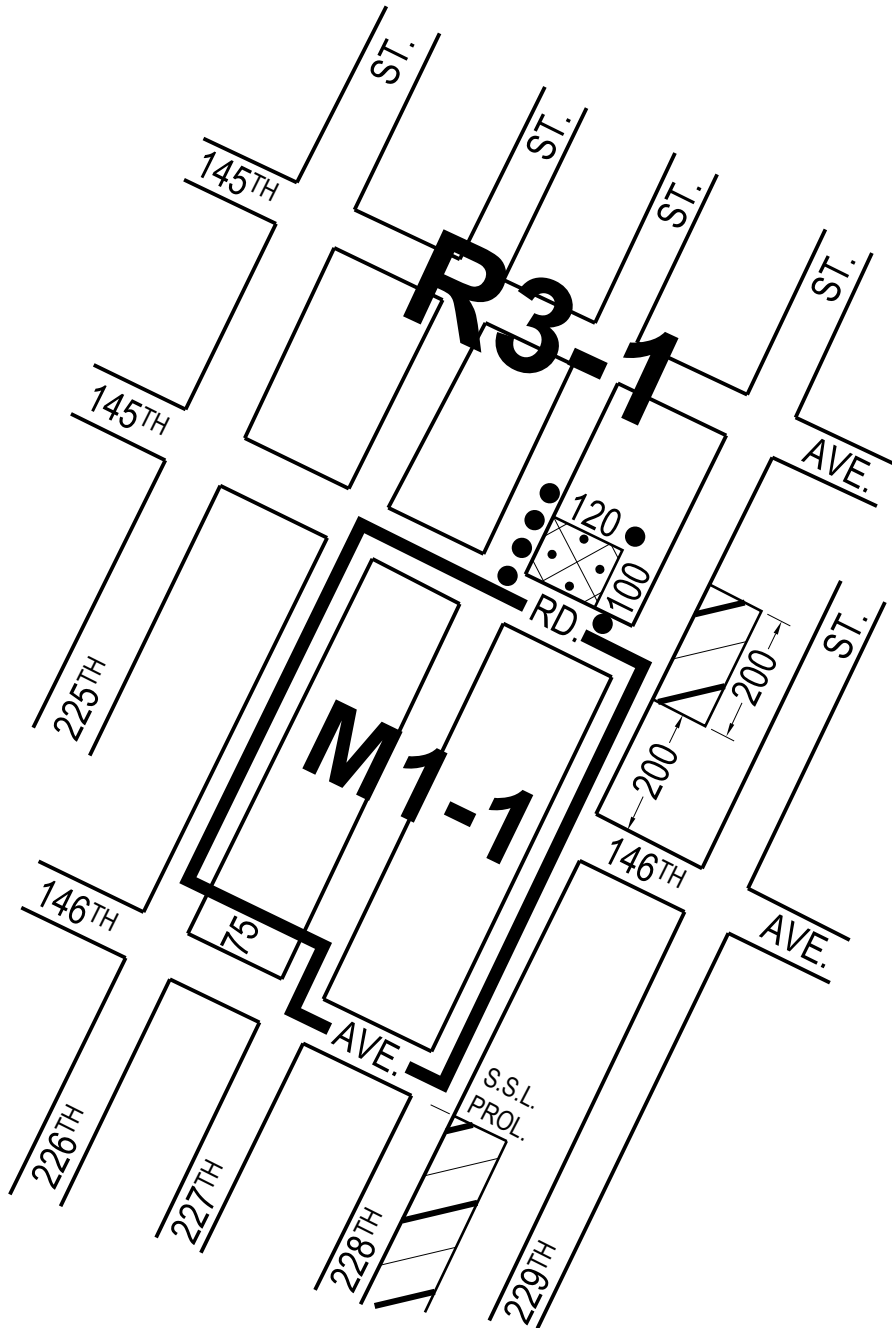

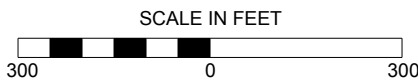

CITY PLANNING COMMISSION  
 CITY OF NEW YORK  
 DIAGRAM SHOWING  
**ZONING CHANGE**  
 ON SECTIONAL MAP  
**19b**  
 BOROUGH OF  
**QUEENS**

EFFECTIVE DATE  
**December 6, 2016**  
 C. C. RESO. # 1327

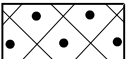

NOTE:

-  Indicates Zoning District Boundary.
-  The area enclosed by the dotted line is rezoned by establishing a C2-2 District within an existing R3-1 District.
-  Indicates a C1-3 District.
-  Indicates a C2-2 District.

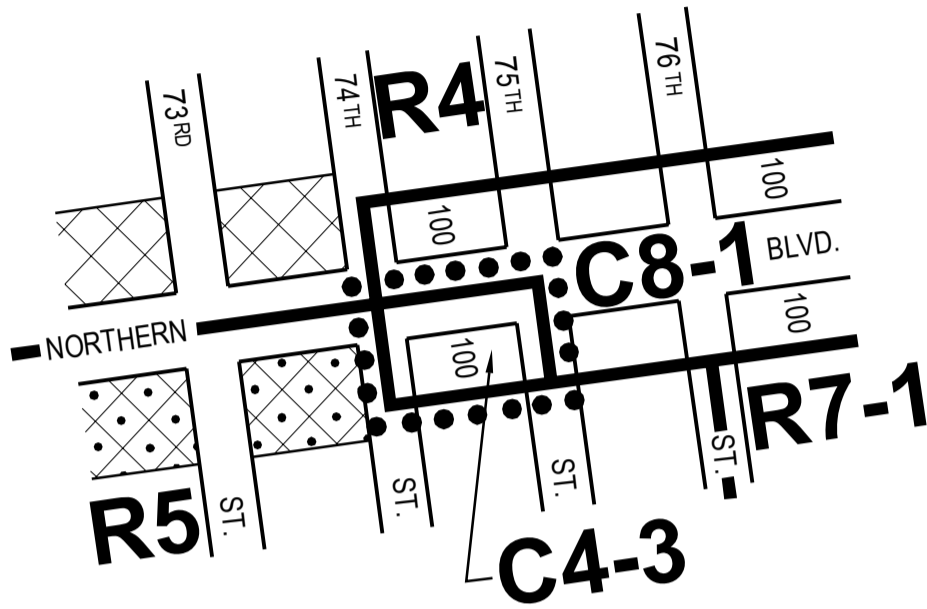





CITY PLANNING COMMISSION  
 CITY OF NEW YORK  
 DIAGRAM SHOWING  
**ZONING CHANGE**  
 ON SECTIONAL MAP  
**9d**

BOROUGH OF  
**QUEENS**

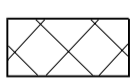

EFFECTIVE DATE  
**June 21, 2017**  
 C. C. RESO. # 1576

NOTE:

-  Indicates Zoning District Boundary.
-  The area enclosed by the dotted line is rezoned by changing a C8-1 District to a C4-3 District.
-  Indicates a C1-2 District.
-  Indicates a C2-2 District.

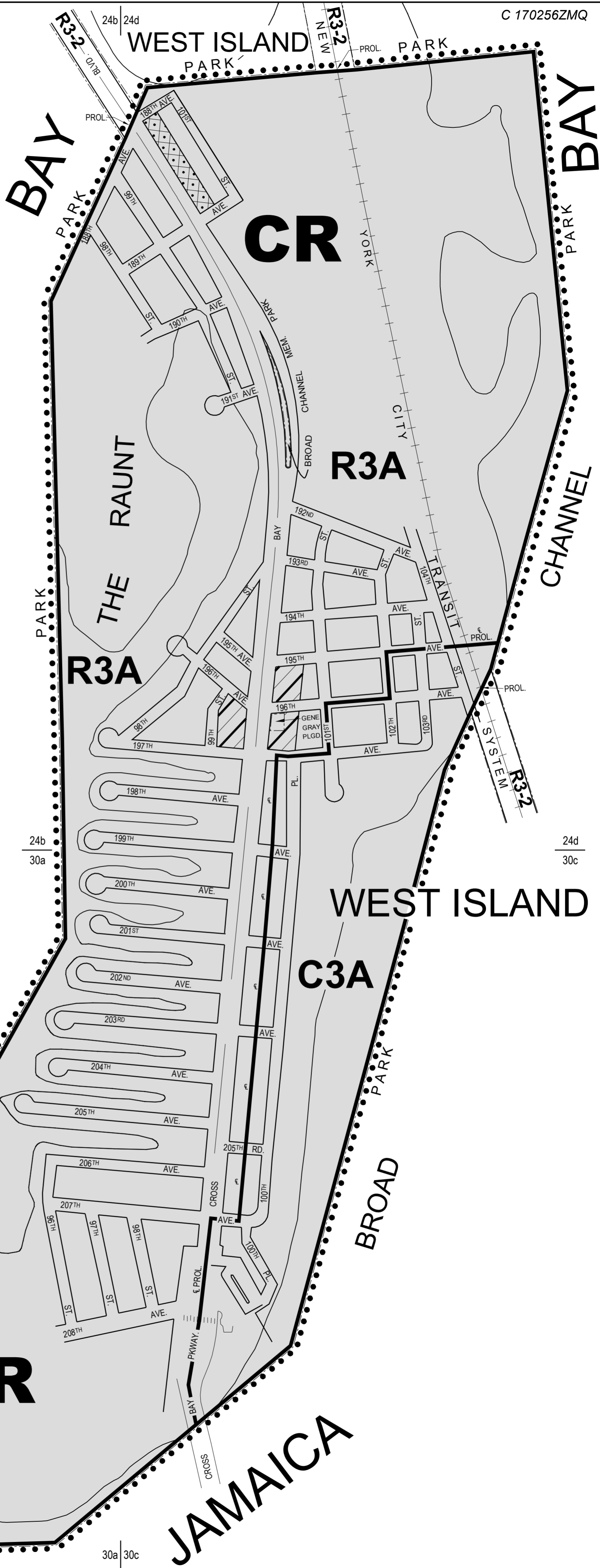

CITY PLANNING COMMISSION  
 CITY OF NEW YORK  
 DIAGRAM SHOWING  
**ZONING CHANGE**  
 ON SECTIONAL MAP  
**24b, 24d, 30a & 30c**  
 BOROUGH OF  
**QUEENS**

EFFECTIVE DATE  
**June 21, 2017**  
 C. C. RESO. # 1578



- NOTE:
- Indicates Zoning District Boundary.
  - The area enclosed by the dotted line is rezoned by eliminating from within an existing R3-2 District a C1-2 District, changing from an R3-2 District to R3A and C3A Districts, establishing within a proposed R3A District a C1-3 District, and establishing a Special Coastal Risk District.
  - Indicates a C1-3 District.
  - Indicates a C2-2 District.
  - CR** Indicates a Special Coastal Risk District.

NOTE: THIS DIAGRAM IS FOR ILLUSTRATIVE PURPOSES ONLY.

CITY PLANNING COMMISSION

CITY OF NEW YORK

DIAGRAM SHOWING

**ZONING CHANGE**

ON SECTIONAL MAP

**18b**

BOROUGH OF



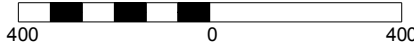

**QUEENS**

SCALE IN FEET



EFFECTIVE DATE  
**June 21, 2017**  
 C. C. RESO. # 1580

NOTE:

-  Indicates Zoning District Boundary.
-  The area enclosed by the dotted line is rezoned by eliminating a C1-2 District from within an existing R3-1 District, by changing an R3-1 District to an R3A District, by establishing C1-3 Districts within an existing R3-1 District and a proposed R3A District, and by establishing a Special Coastal Risk District.
-  Indicates a C1-3 District.
-  **CR** Indicates a Special Coastal Risk District.

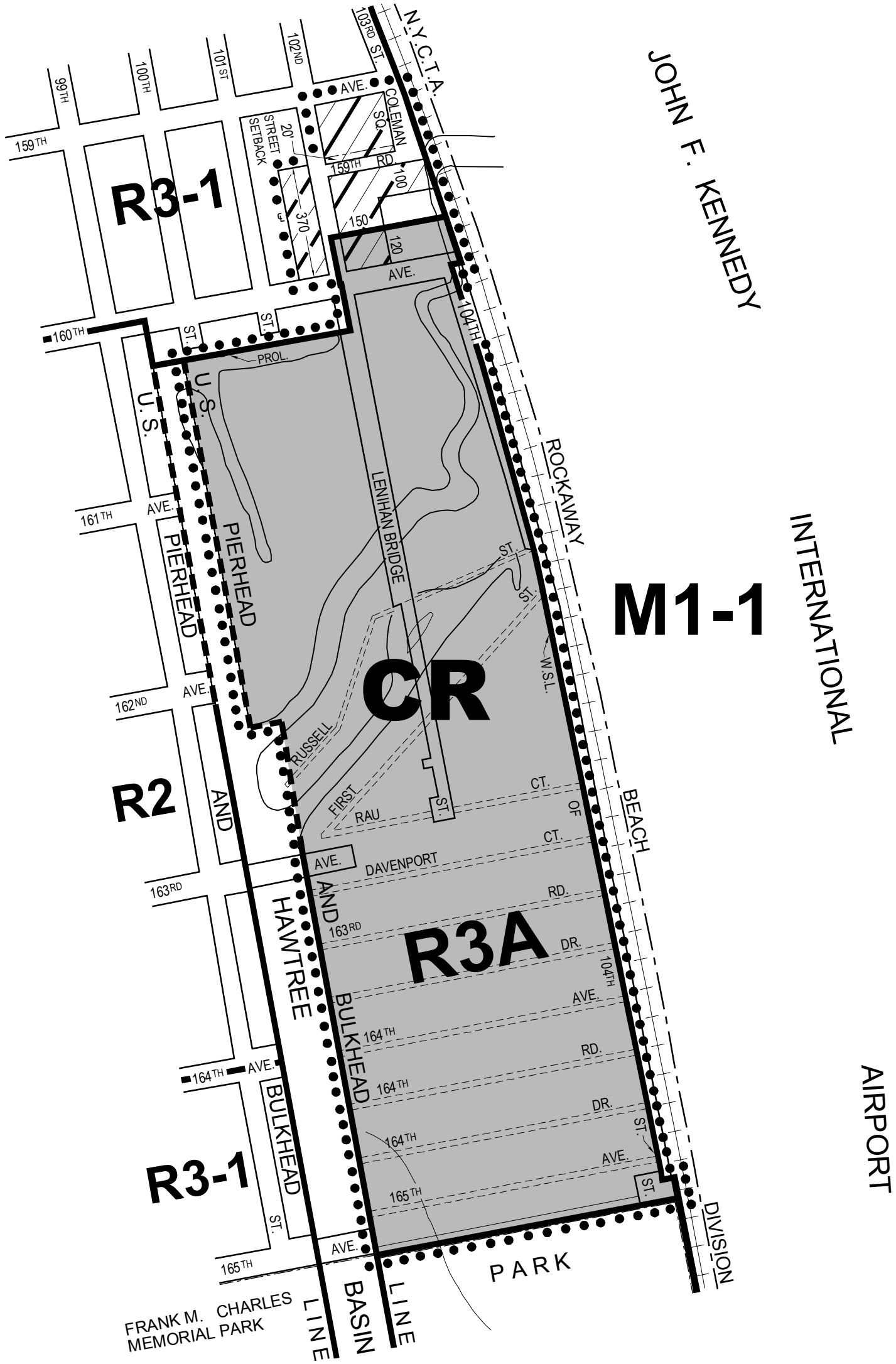

NOTE: THIS DIAGRAM IS FOR ILLUSTRATIVE PURPOSES ONLY.

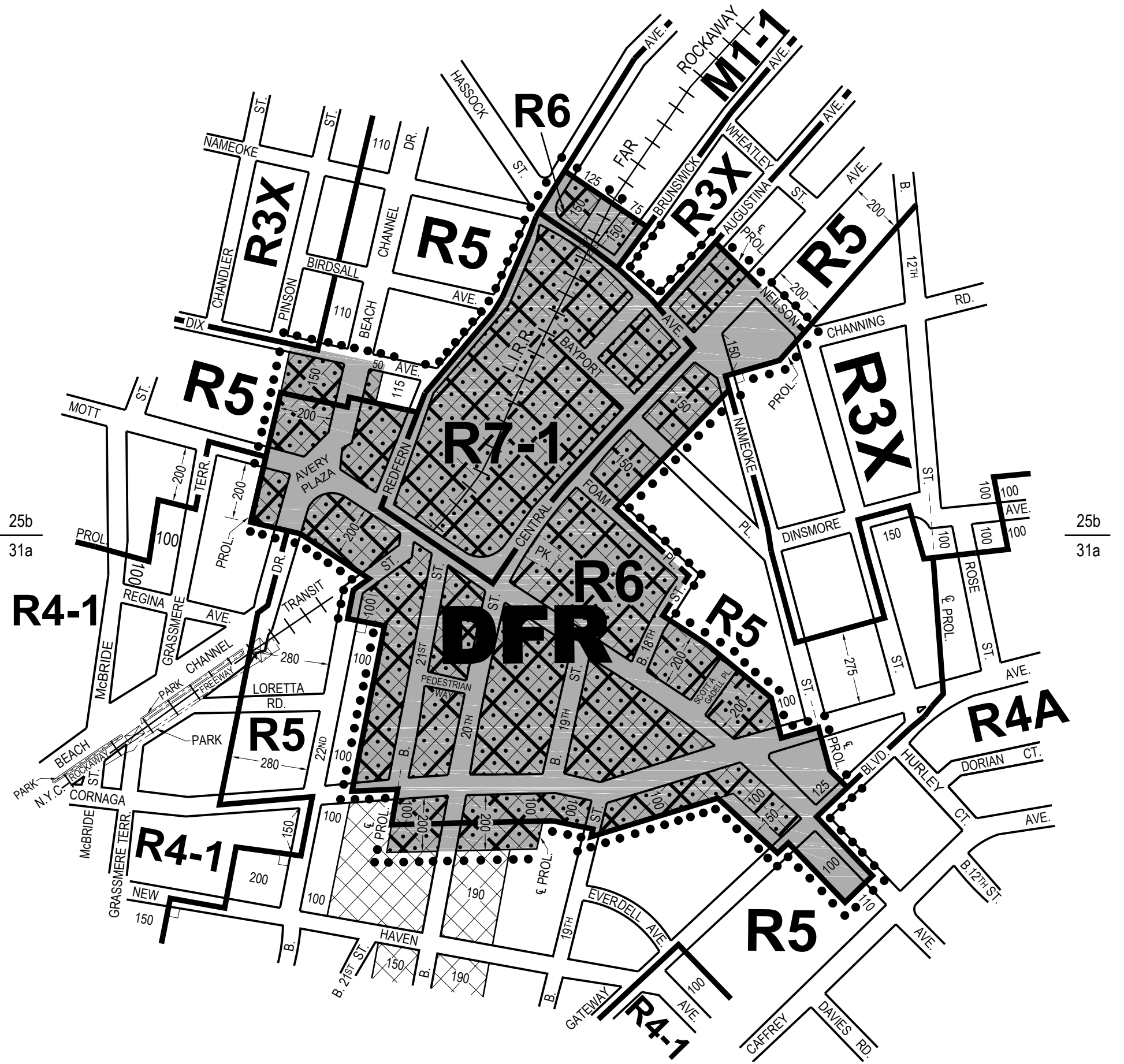

CITY PLANNING COMMISSION  
 CITY OF NEW YORK  
 DIAGRAM SHOWING  
**ZONING CHANGE**  
 ON SECTIONAL MAP  
**25b & 31a**  
 BOROUGH OF  
**QUEENS**



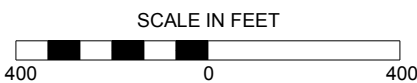

EFFECTIVE DATE  
**September 07, 2017**  
 C. C. RESO. # 1650

New York, Certification Date  
**APRIL 26, 2017**

S. Lenard, Director  
 Technical Review Division

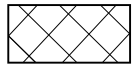

**NOTE:**

-  Indicates Zoning District Boundary.
-  The area enclosed by the dotted line is rezoned by eliminating C1-2 and C2-2 Districts from within existing R3X and R5 Districts, by changing R5, C4-2, C8-1 and M1-1 Districts to R5, R6 and R7-1 Districts, by establishing a C2-4 District within existing and proposed R5, R6 and R7-1 Districts, and by establishing a Special Downtown Far Rockaway District.
-  Indicates a C1-2 District.
-  Indicates a C2-4 District.
-  **DFR** Indicates a Special Downtown Far Rockaway District.

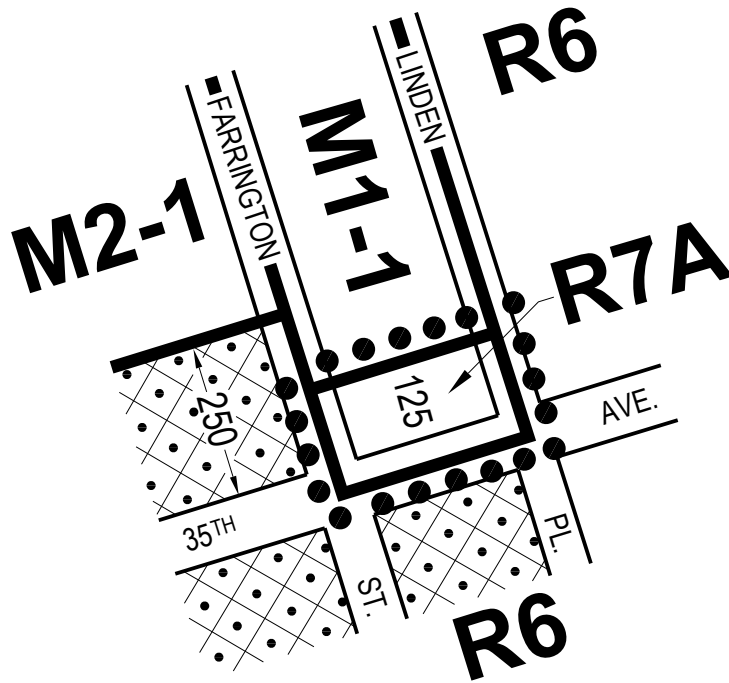

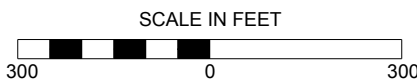

CITY PLANNING COMMISSION  
 CITY OF NEW YORK  
 DIAGRAM SHOWING  
**ZONING CHANGE**  
 ON SECTIONAL MAP  
**10a**  
 BOROUGH OF  
**QUEENS**

EFFECTIVE DATE  
**October 17, 2017**  
 C. C. RESO. # 1685

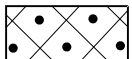

NOTE:

-  Indicates Zoning District Boundary.
-  The area enclosed by the dotted line is rezoned by changing an M1-1 District to an R7A District.
-  Indicates a C2-2 District.



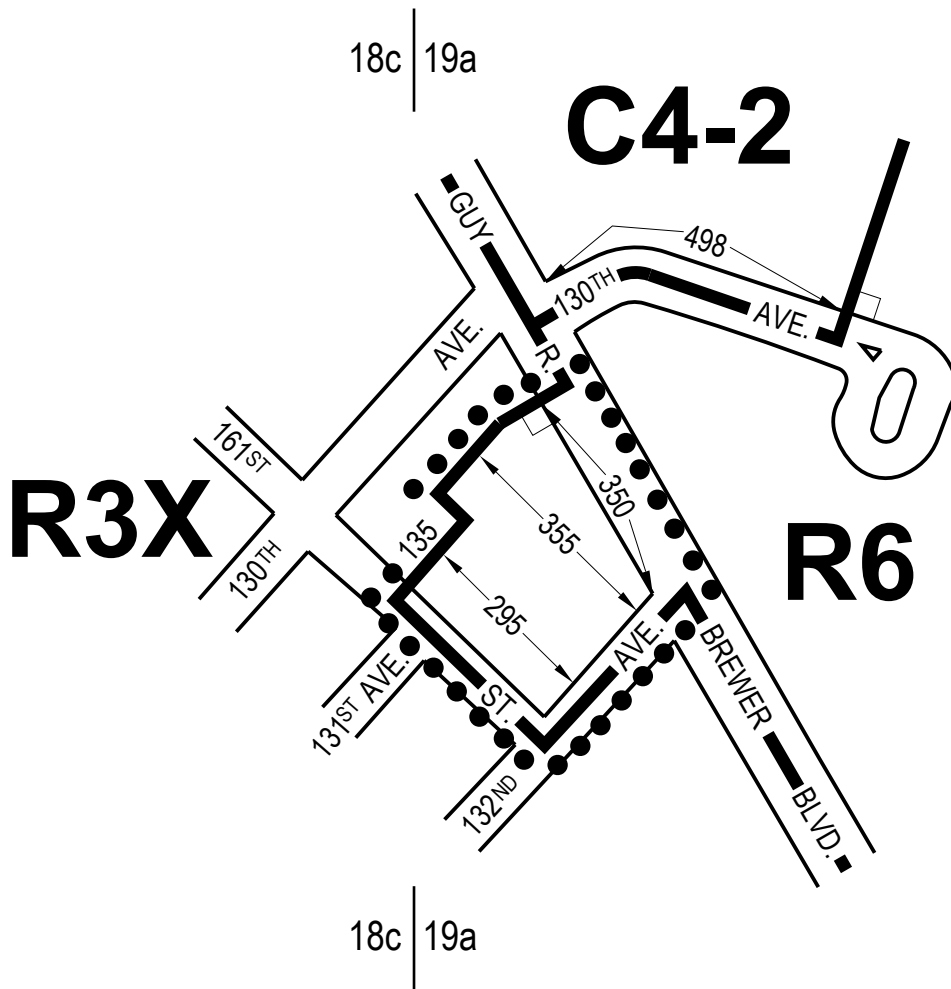

CITY PLANNING COMMISSION  
 CITY OF NEW YORK  
 DIAGRAM SHOWING  
**ZONING CHANGE**  
 ON SECTIONAL MAP  
**18c & 19a**  
 BOROUGH OF  
**QUEENS**

EFFECTIVE DATE  
**October 17, 2017**  
 C. C. RESO. # 1688

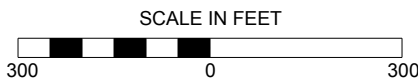

NOTE:

- Indicates Zoning District Boundary.
- The area enclosed by the dotted line is rezoned by changing an existing R3X District to an R6 District.

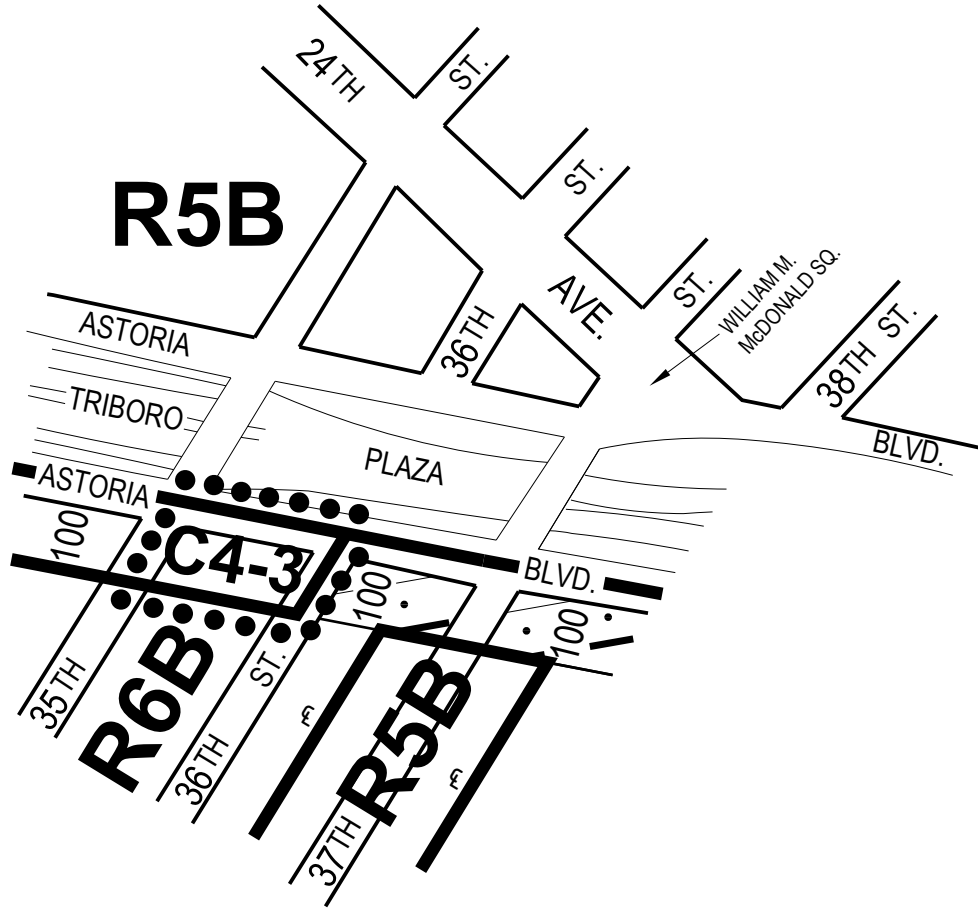

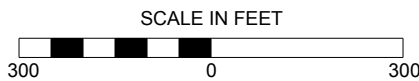

CITY PLANNING COMMISSION  
 CITY OF NEW YORK  
 DIAGRAM SHOWING  
**ZONING CHANGE**  
 ON SECTIONAL MAP  
**9a**  
 BOROUGH OF  
**QUEENS**

EFFECTIVE DATE  
**March 22, 2018**  
 C. C. RESO. # 266



NOTE:

-  Indicates Zoning District Boundary.
-  The area enclosed by the dotted line is rezoned by changing an existing R6B District to a C4-3 District.
-  Indicates a C2-3 District.

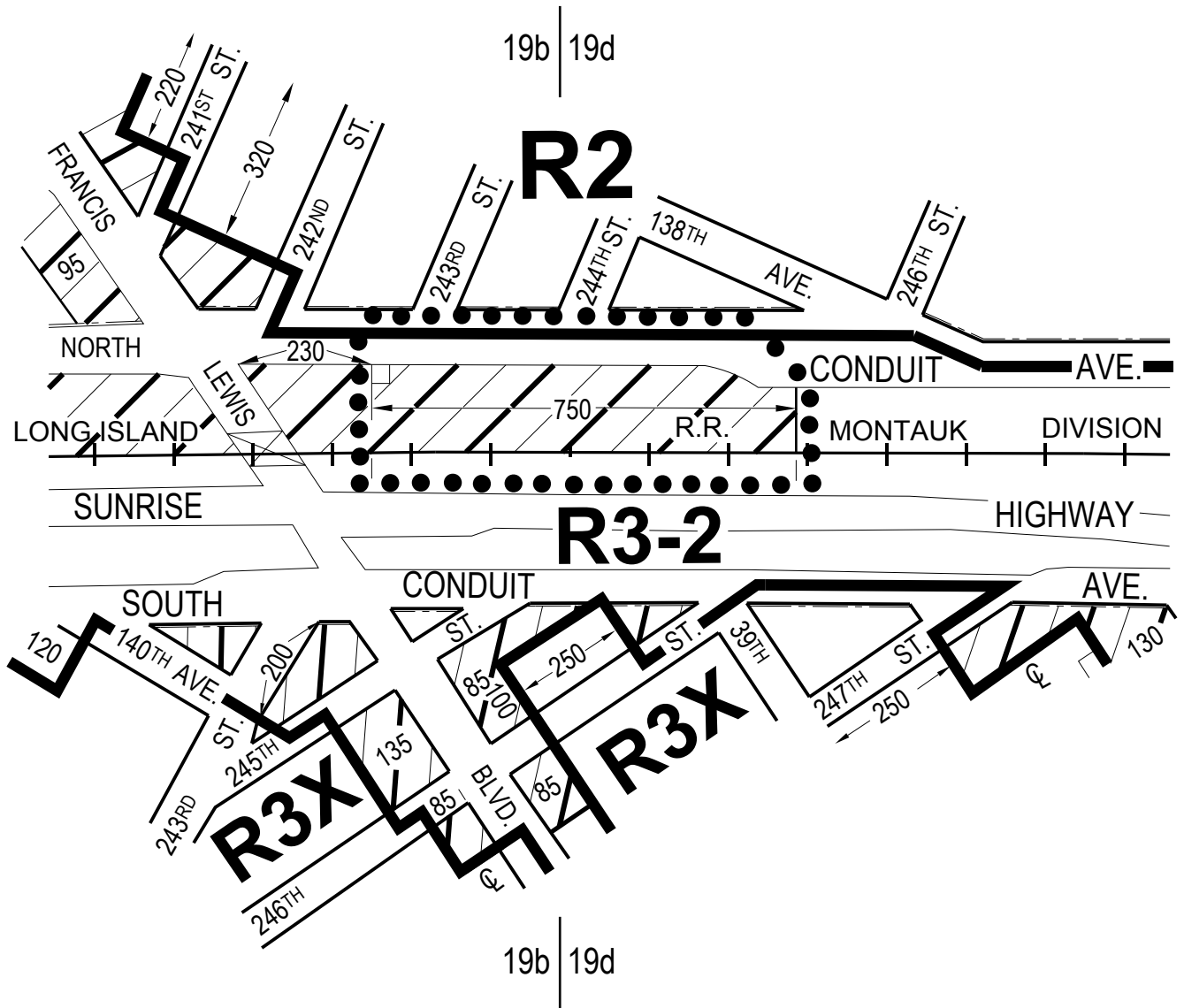

CITY PLANNING COMMISSION  
 CITY OF NEW YORK  
 DIAGRAM SHOWING  
**ZONING CHANGE**  
 ON SECTIONAL MAP  
**19b & 19d**  
 BOROUGH OF  
**QUEENS**

EFFECTIVE DATE  
**May 9, 2018**  
 C. C. RESO. # 349

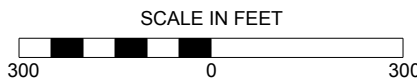

NOTE:

- Indicates Zoning District Boundary.
- The area enclosed by the dotted line is rezoned by establishing a C1-3 District within an existing R3-2 District.
- Indicates a C1-3 District.

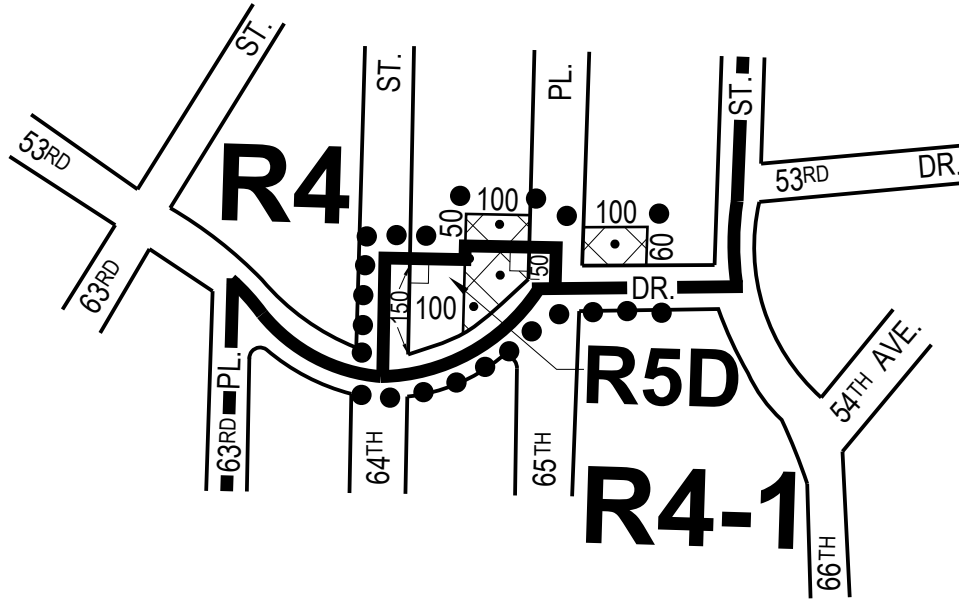

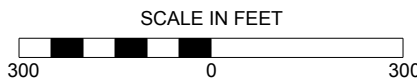

CITY PLANNING COMMISSION  
 CITY OF NEW YORK  
 DIAGRAM SHOWING  
**ZONING CHANGE**  
 ON SECTIONAL MAP  
**13c**  
 BOROUGH OF  
**QUEENS**

EFFECTIVE DATE  
**September 26, 2018**  
 C. C. RESO. # 552



NOTE:

-  Indicates Zoning District Boundary.
-  The area enclosed by the dotted line is rezoned by changing an existing R4 District to an R5D District, and by establishing C2-2 Districts within an existing R4 District and proposed R5D.
-  Indicates a C2-2 District.

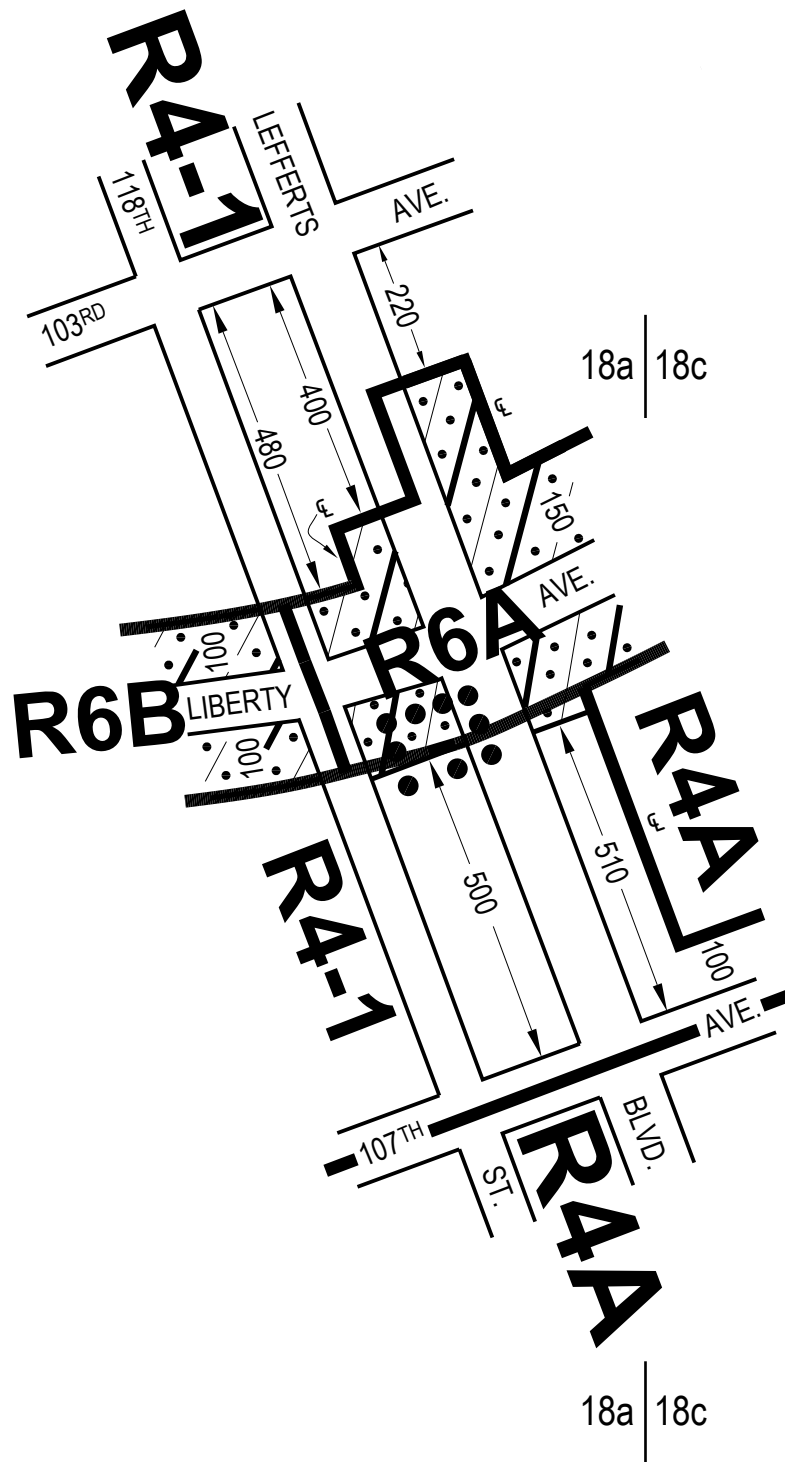

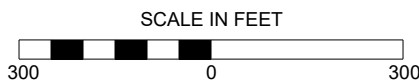

CITY PLANNING COMMISSION  
 CITY OF NEW YORK  
 DIAGRAM SHOWING  
**ZONING CHANGE**  
 ON SECTIONAL MAP  
**18a**  
 BOROUGH OF  
**QUEENS**

EFFECTIVE DATE  
**October 17, 2018**  
 C. C. RESO. # 570



NOTE:

-  Indicates Zoning District Boundary.
-  The area enclosed by the dotted line is rezoned by establishing C2-3 Districts within existing R4-1 and R6A Districts.
-  Indicates a C2-3 District.

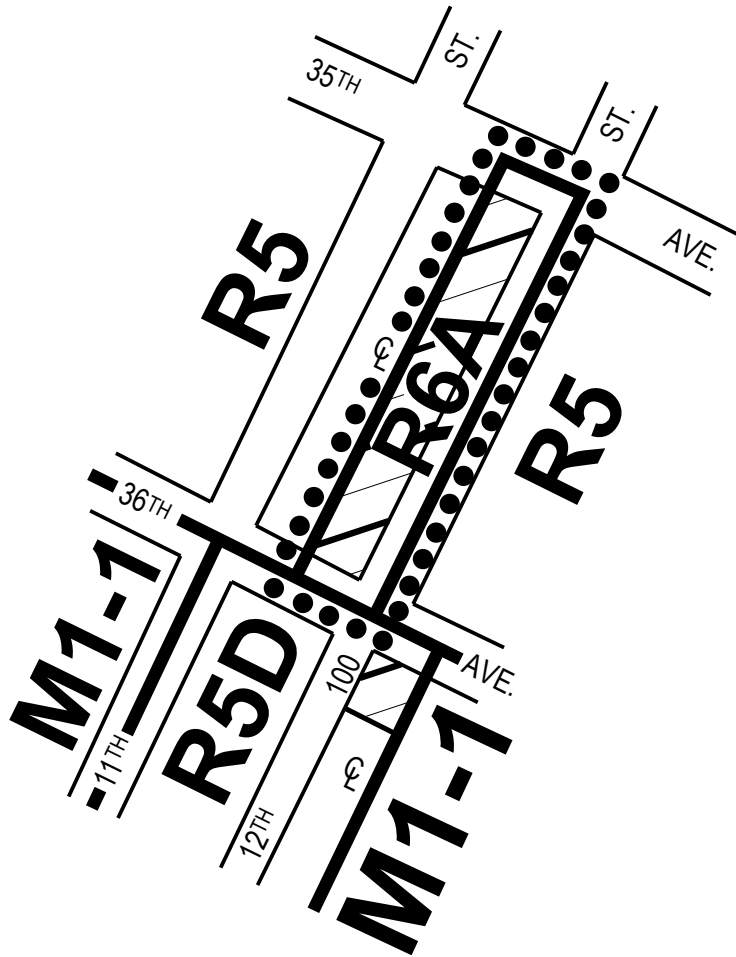

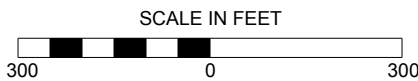

CITY PLANNING COMMISSION  
 CITY OF NEW YORK  
 DIAGRAM SHOWING  
**ZONING CHANGE**  
 ON SECTIONAL MAP  
**9a**  
 BOROUGH OF  
**QUEENS**

EFFECTIVE DATE  
**October 31, 2018**  
 C. C. RESO. # 597



NOTE:

-  Indicates Zoning District Boundary.
-  The area enclosed by the dotted line is rezoned by changing an R5 District to a R6A District, and by establishing a C1-3 District within the proposed R6A District.
-  Indicates a C1-3 District.

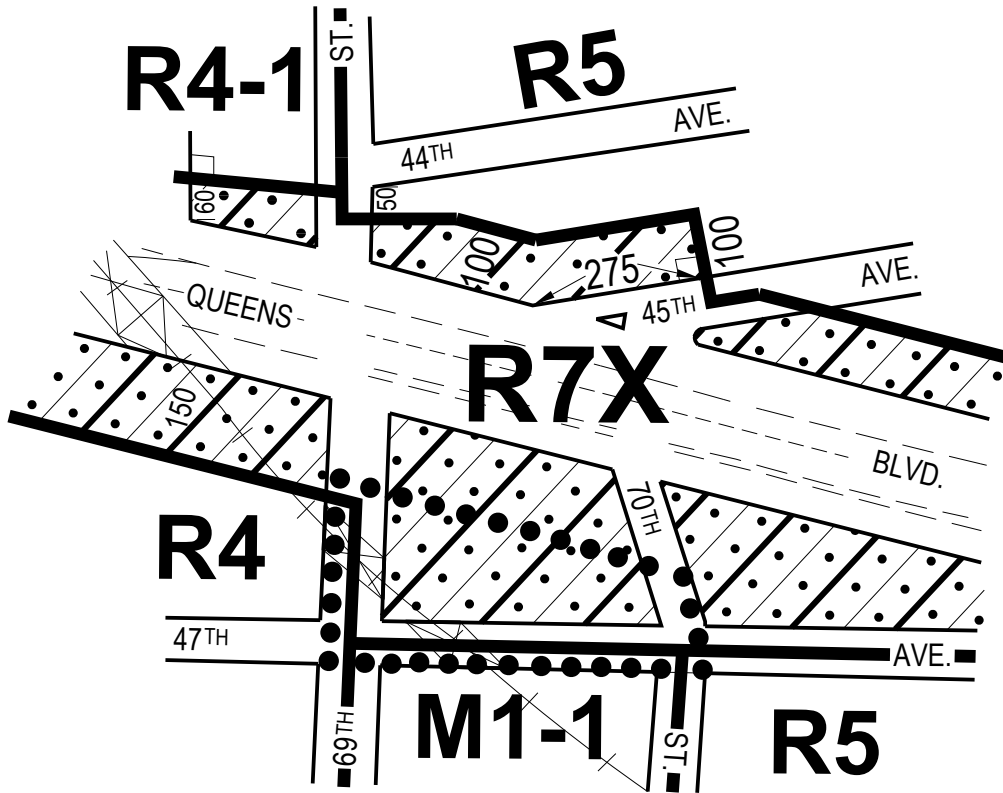

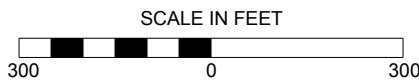

CITY PLANNING COMMISSION  
 CITY OF NEW YORK  
 DIAGRAM SHOWING  
**ZONING CHANGE**  
 ON SECTIONAL MAP  
**9d**  
 BOROUGH OF  
**QUEENS**

EFFECTIVE DATE  
**October 31, 2018**  
 C. C. RESO. # 601



NOTE:

-  Indicates Zoning District Boundary.
-  The area enclosed by the dotted line is rezoned by changing from an M1-1 District to an R7X District and establishing a C2-3 District within the proposed R7X District.
-  Indicates a C2-3 District.

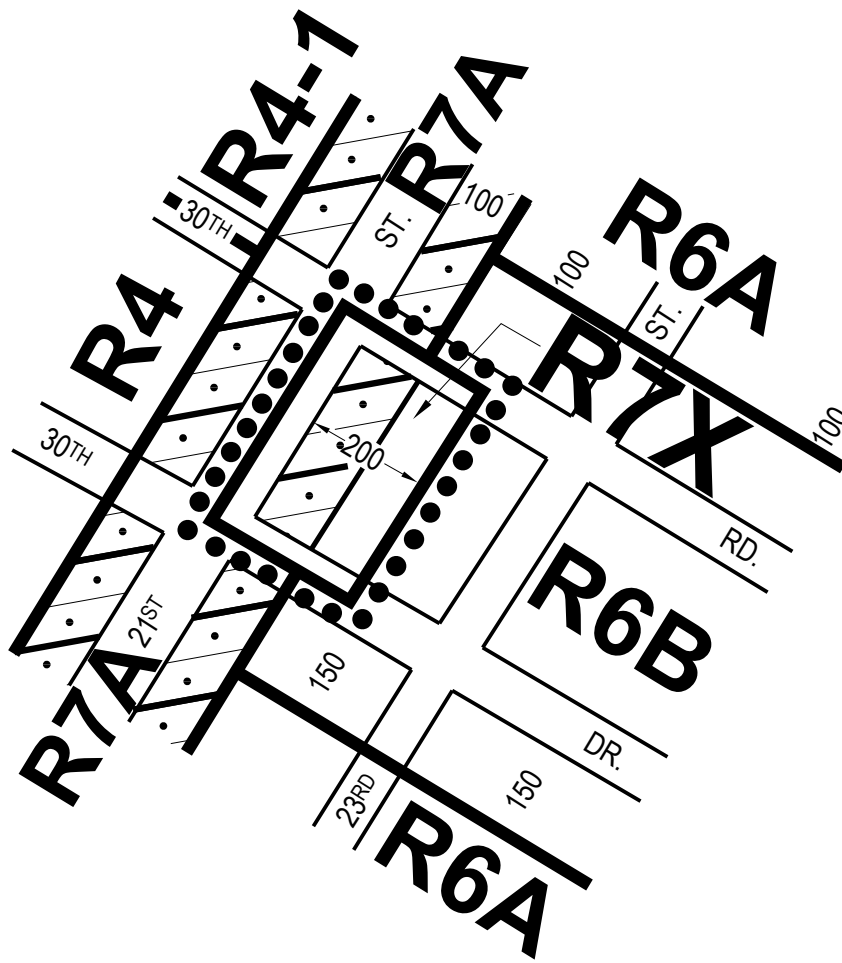

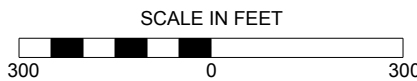

CITY PLANNING COMMISSION  
 CITY OF NEW YORK  
 DIAGRAM SHOWING  
**ZONING CHANGE**  
 ON SECTIONAL MAP  
**9a**  
 BOROUGH OF  
**QUEENS**

EFFECTIVE DATE  
**October 31, 2018**  
 C. C. RESO. # 604



NOTE:

-  Indicates Zoning District Boundary.
-  The area enclosed by the dotted line is rezoned by changing existing R6B and R7A Districts to an R7X District.
-  Indicates a C2-3 District.



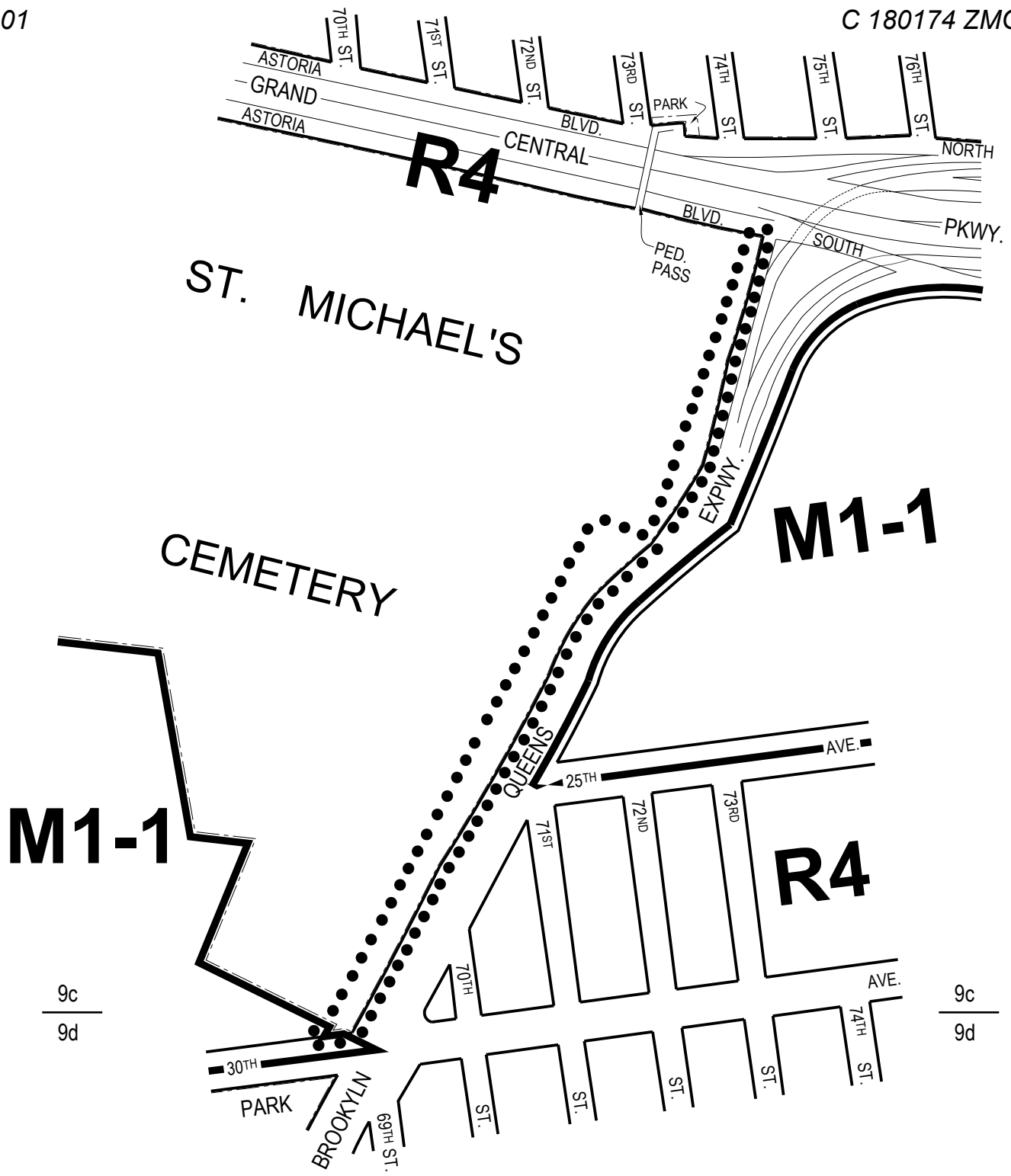

9c  
9d

9c  
9d



CITY PLANNING COMMISSION  
 CITY OF NEW YORK  
 DIAGRAM SHOWING  
**ZONING CHANGE**  
 ON SECTIONAL MAP  
**9c & 9d**  
 BOROUGH OF  
**QUEENS**

EFFECTIVE DATE  
**November 14, 2018**  
 C. C. RESO. # 628

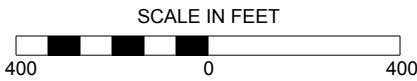

- NOTE:
- Indicates Zoning District Boundary.
  - The area enclosed by the dotted line is rezoned by establishing an R4 District within a former Park.

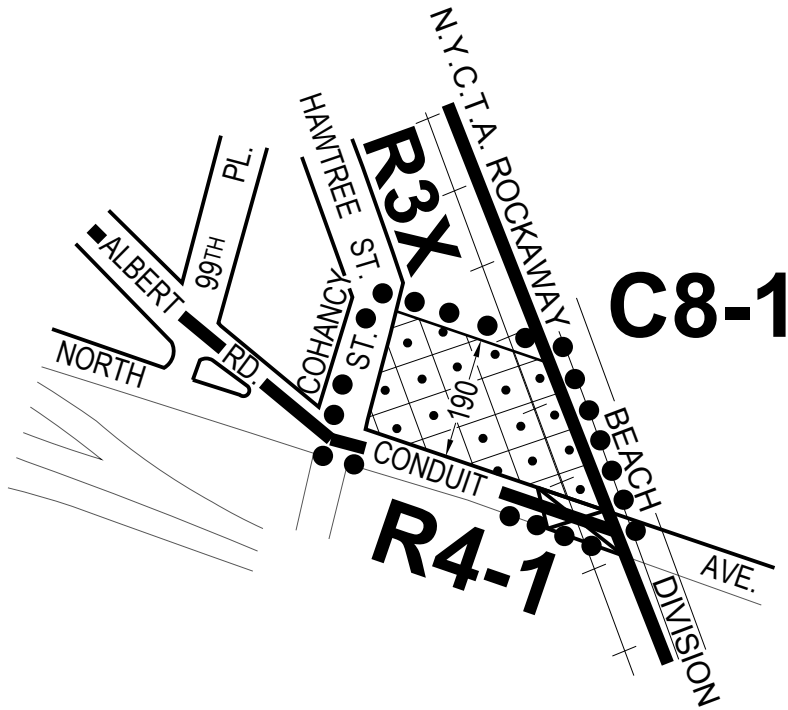

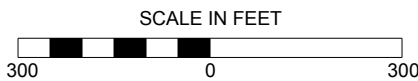

CITY PLANNING COMMISSION  
 CITY OF NEW YORK  
 DIAGRAM SHOWING  
**ZONING CHANGE**  
 ON SECTIONAL MAP  
**18b**  
 BOROUGH OF  
**BROOKLYN**

EFFECTIVE DATE  
**February 13, 2019**  
 C. C. RESO. # 758



NOTE:

-  Indicates Zoning District Boundary.
-  The area enclosed by the dotted line is rezoned by establishing a C2-2 District in an existing R3X District.
-  Indicates a C2-2 District.

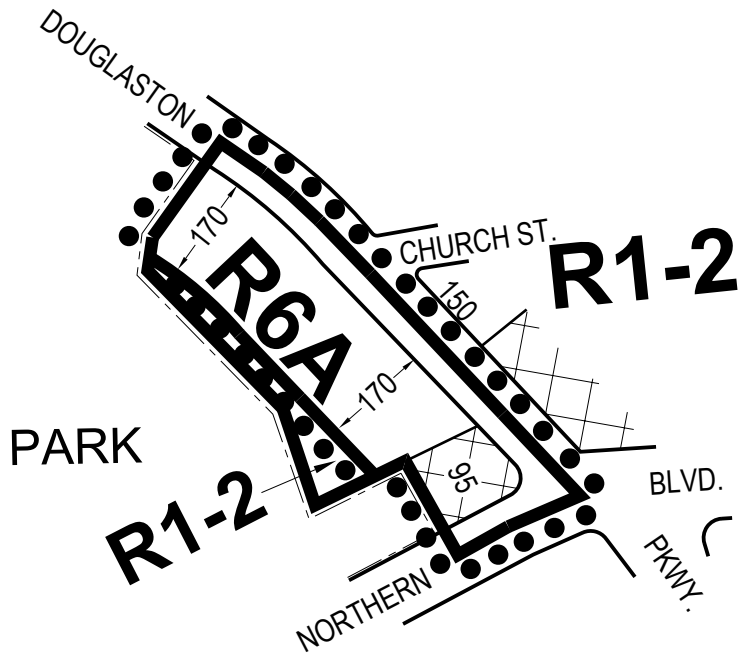

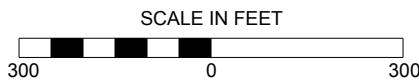

CITY PLANNING COMMISSION  
 CITY OF NEW YORK  
 DIAGRAM SHOWING  
**ZONING CHANGE**  
 ON SECTIONAL MAP  
**11a**  
 BOROUGH OF  
**QUEENS**

EFFECTIVE DATE  
**March 13, 2019**  
 C. C. RESO. # 784

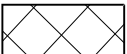

NOTE:

-  Indicates Zoning District Boundary.
-  The area enclosed by the dotted line is rezoned by changing an existing R1-2 District to an R6A District and by establishing a C1-2 District within the proposed R6A District.
-  Indicates a C1-2 District.

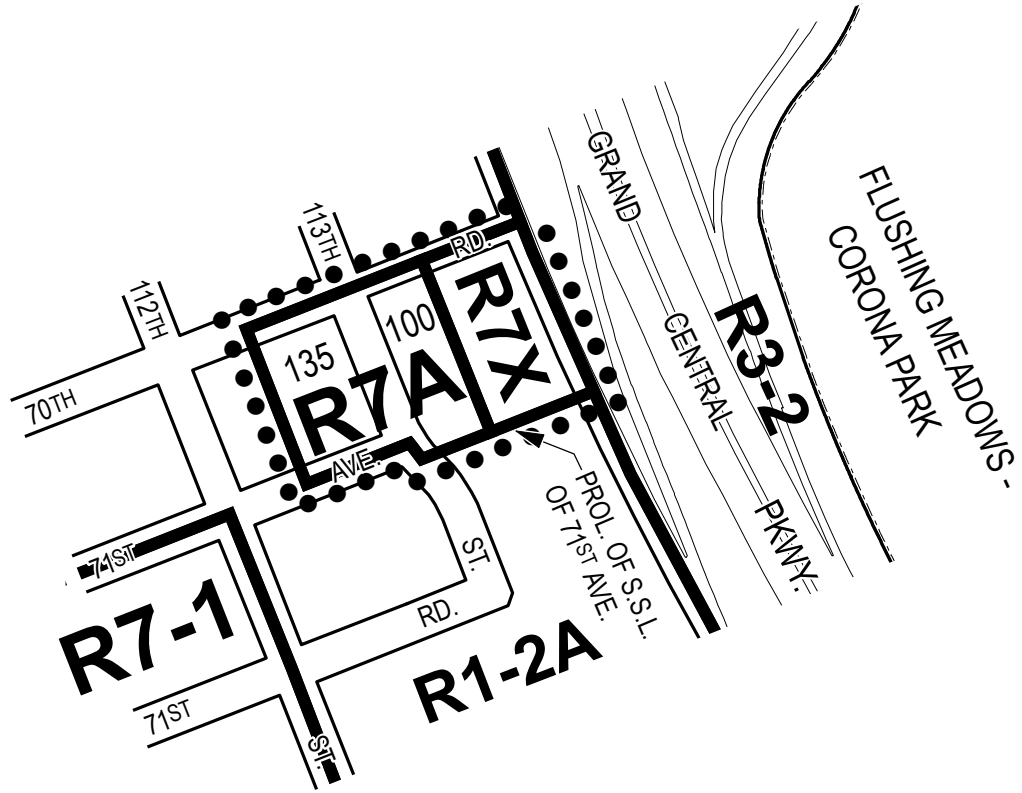

CITY PLANNING COMMISSION  
 CITY OF NEW YORK  
 DIAGRAM SHOWING  
**ZONING CHANGE**  
 ON SECTIONAL MAP  
**14a**  
 BOROUGH OF  
**QUEENS**

EFFECTIVE DATE <b>April 09, 2019</b> C. C. RESO. # 842
--

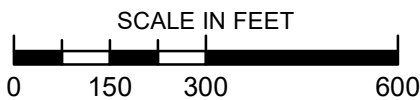

**NOTE:**

- Indicates Zoning District Boundary
- The area enclosed by the dotted line is rezoned by changing an existing R1-2A District to R7A and R7X Districts.

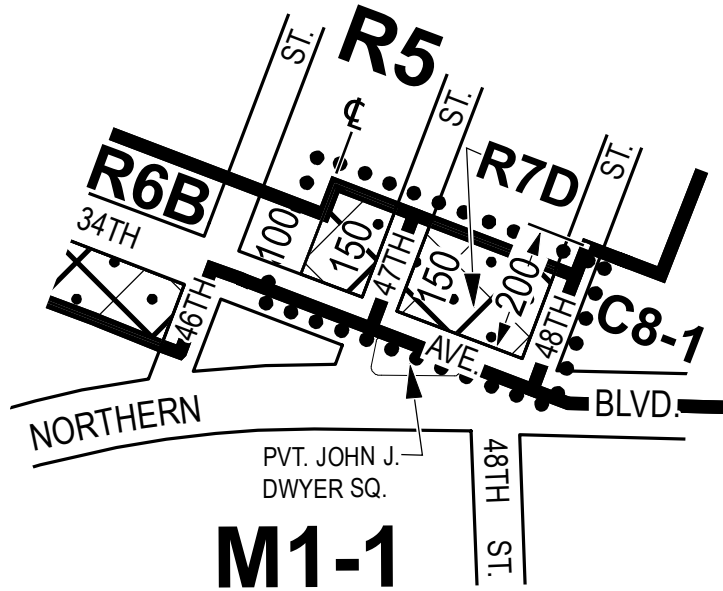



CITY PLANNING COMMISSION  
 CITY OF NEW YORK  
 DIAGRAM SHOWING  
**ZONING CHANGE**  
 ON SECTIONAL MAP

**9b**  
 BOROUGH OF  
**QUEENS**

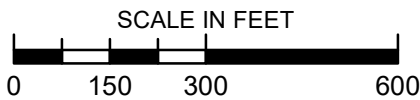
EFFECTIVE DATE
<b>May 29, 2019</b>
C. C. RESO. # 912



**NOTE:**

-  Indicates Zoning District Boundary
-  The area enclosed by the dotted line is rezoned by changing R5 and C8-1 Districts to R6B and R7D Districts and establishing C2-4 Districts within the existing and proposed R6B and proposed R7D District.
-  Indicates a C2-4 District

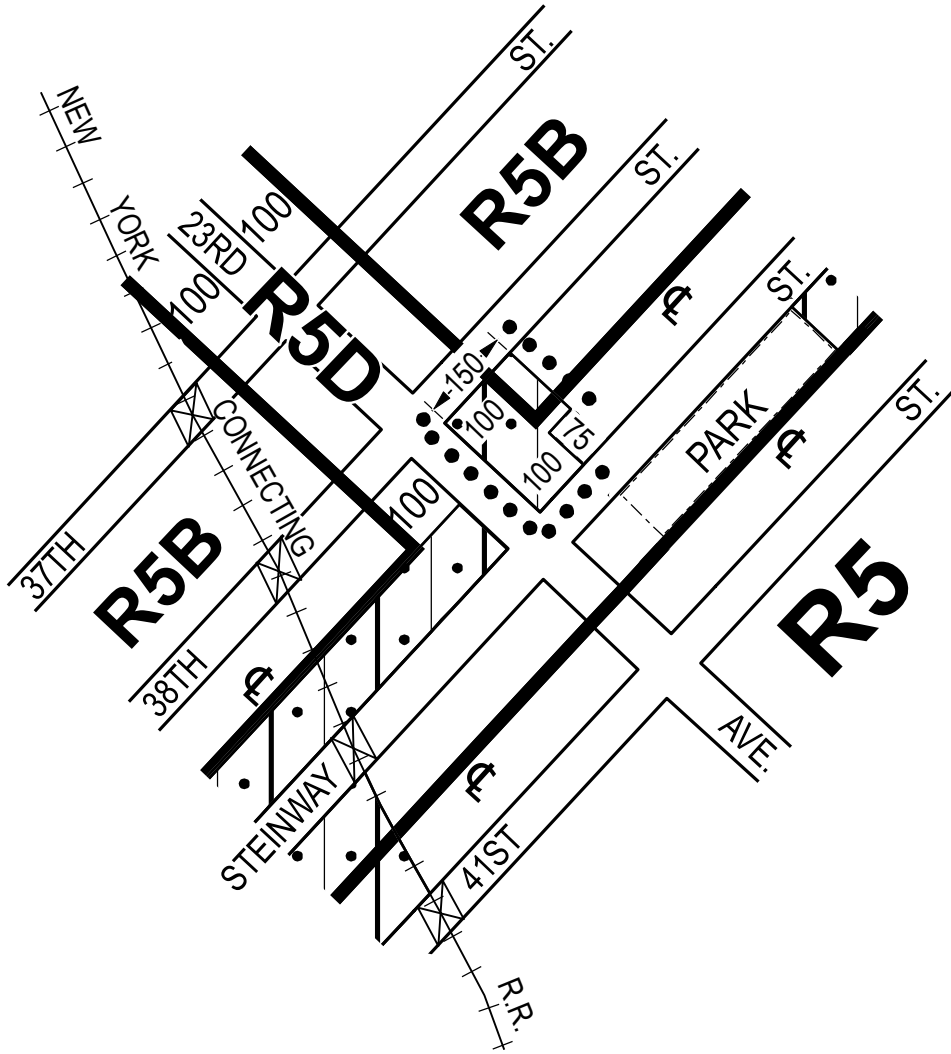



CITY PLANNING COMMISSION  
 CITY OF NEW YORK  
 DIAGRAM SHOWING  
**ZONING CHANGE**  
 ON SECTIONAL MAP  
**9c**  
 BOROUGH OF  
**QUEENS**

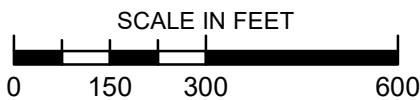

EFFECTIVE DATE  
**July 26, 2019**  
 C. C. RESO. # 1015



**NOTE:**

-  Indicates Zoning District Boundary
-  The area enclosed by the dotted line is rezoned by establishing a C2-3 District within existing R5B and R5D Districts.
-  Indicates a C2-3 District

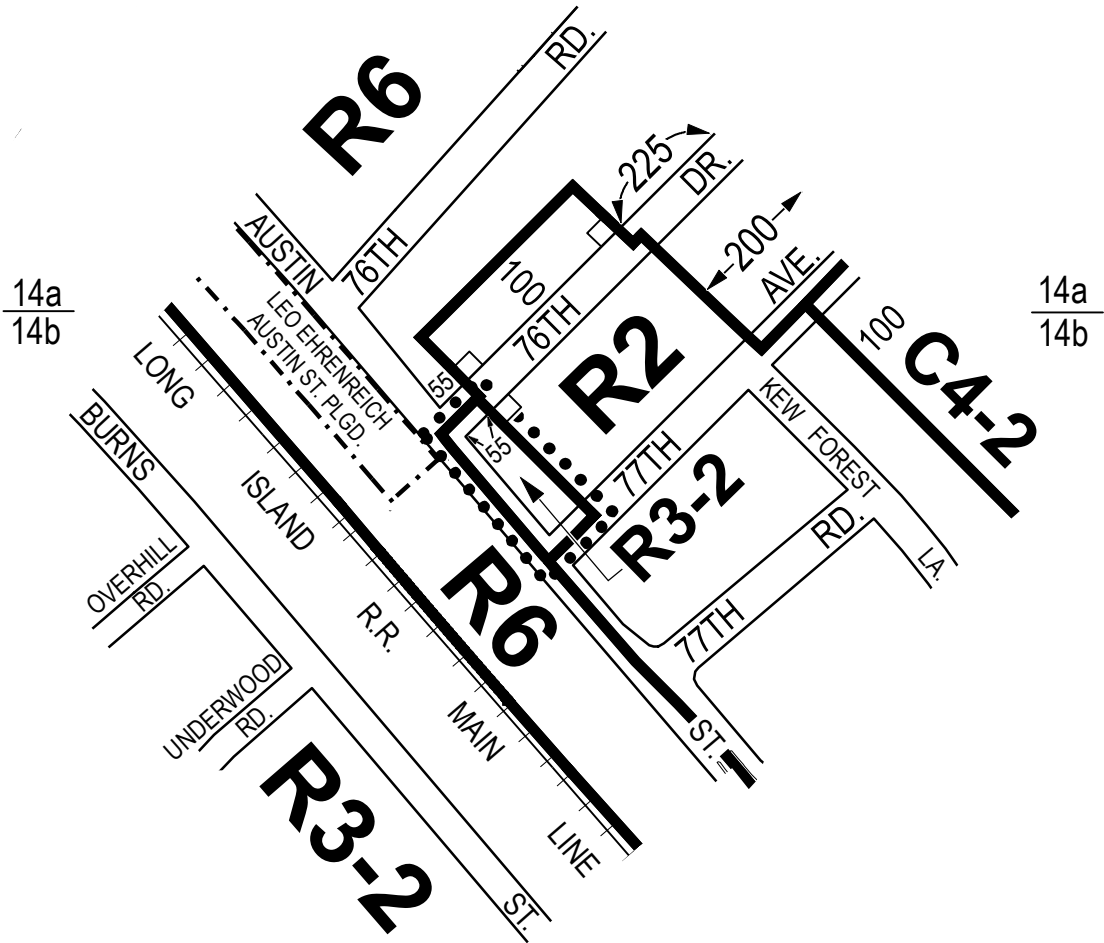

CITY PLANNING COMMISSION  
 CITY OF NEW YORK  
 DIAGRAM SHOWING  
**ZONING CHANGE**  
 ON SECTIONAL MAP

**14b**  
 BOROUGH OF  
**QUEENS**

EFFECTIVE DATE
<b>July 23, 2019</b>
C. C. RESO. # 1016

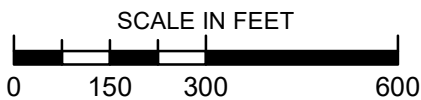

- NOTE:**
- Indicates Zoning District Boundary
  - The area enclosed by the dotted line is rezoned by changing an R2 District to an R3-2 District.

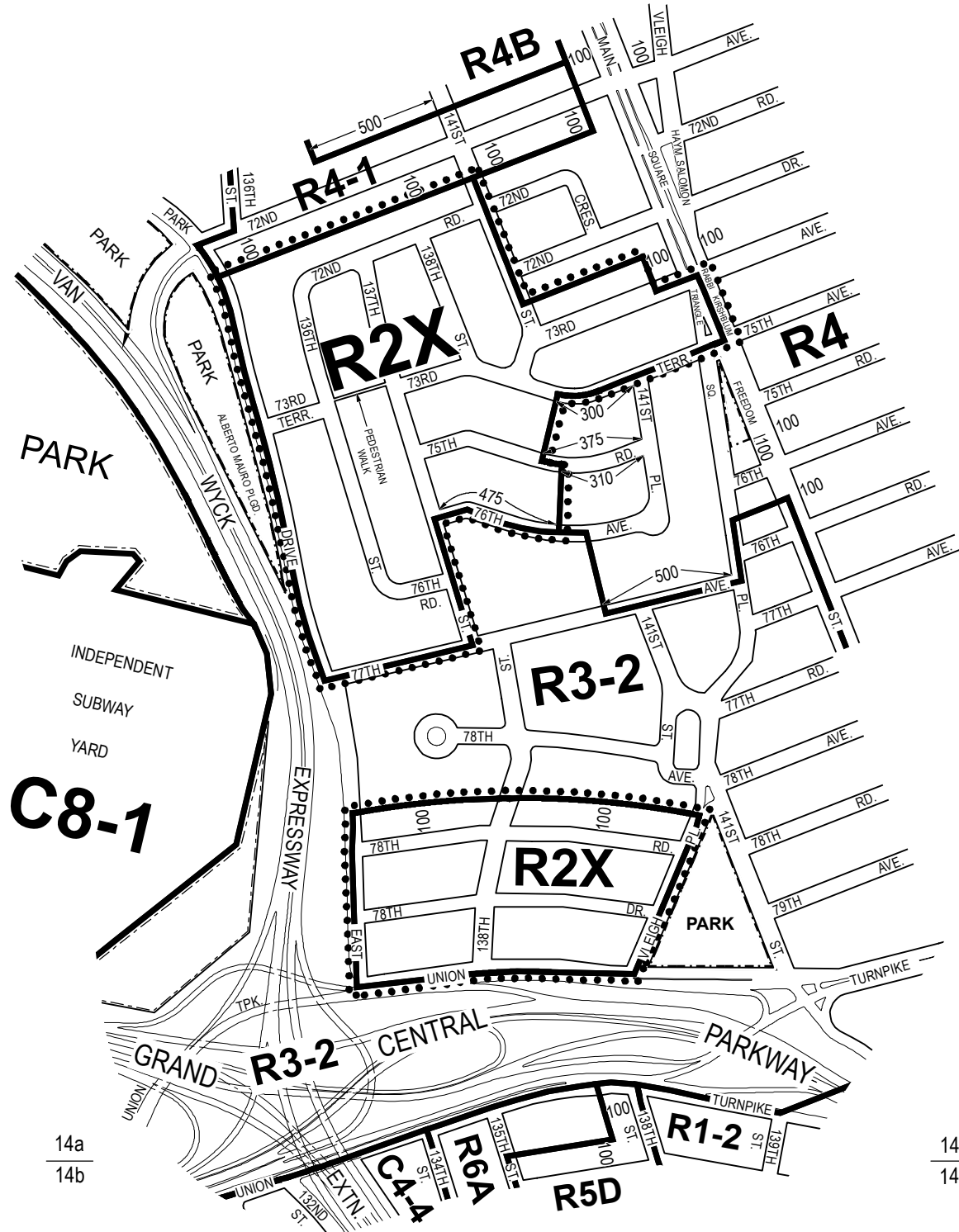

14a  
14b

14c  
14d

14b | 14d

CITY PLANNING COMMISSION  
 CITY OF NEW YORK  
 DIAGRAM SHOWING  
**ZONING CHANGE**  
 ON SECTIONAL MAP  
**14a & 14c**  
 BOROUGH OF  
**QUEENS**

EFFECTIVE DATE
<b>September 25, 2019</b>
C. C. RESO. # 1084

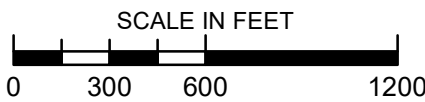

**NOTE:**

- Indicates Zoning District Boundary
- .....** The areas enclosed by the dotted line is rezoned by changing existing R2 Districts to an R2X Districts.



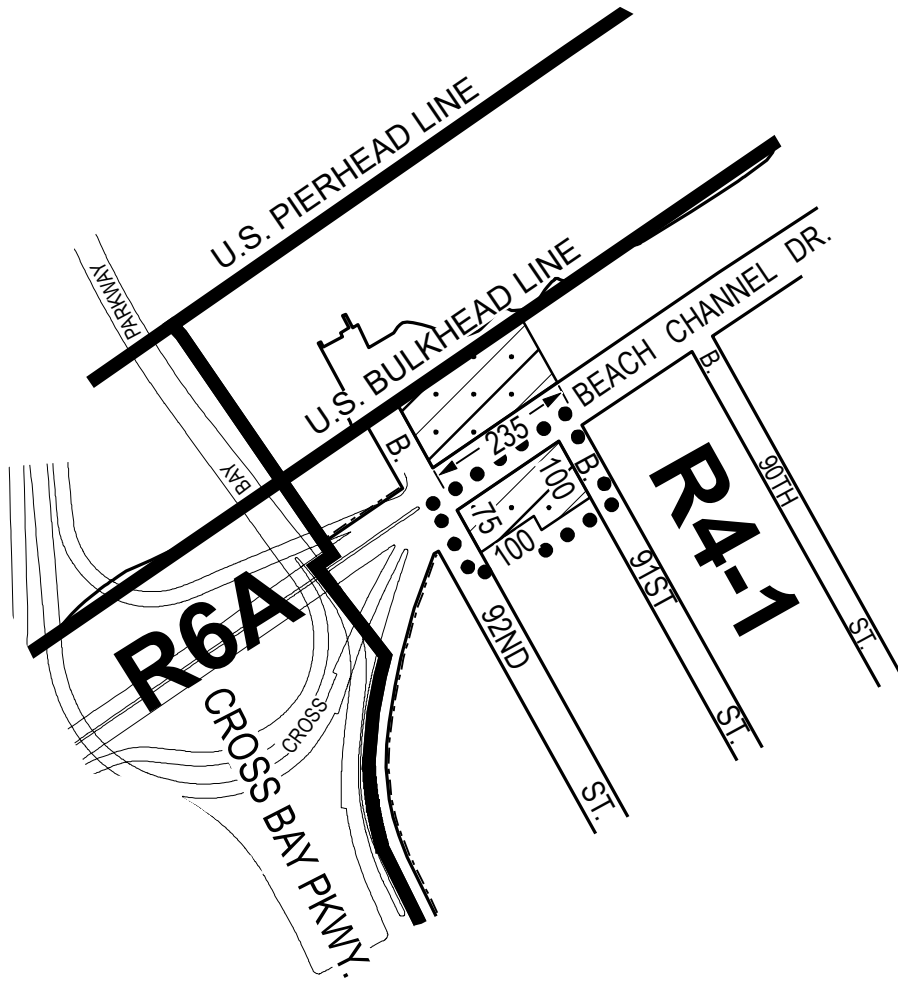



CITY PLANNING COMMISSION  
 CITY OF NEW YORK  
 DIAGRAM SHOWING  
**ZONING CHANGE**  
 ON SECTIONAL MAP  
**30c**  
 BOROUGH OF  
**QUEENS**

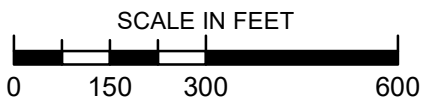

EFFECTIVE DATE
<b>October 17, 2019</b>
C. C. RESO. # 1111

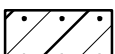

**NOTE:**

-  Indicates Zoning District Boundary
-  The area enclosed by the dotted line is rezoned by establishing a C2-3 District within an existing R4-1 District.
-  Indicates a C2-3 District

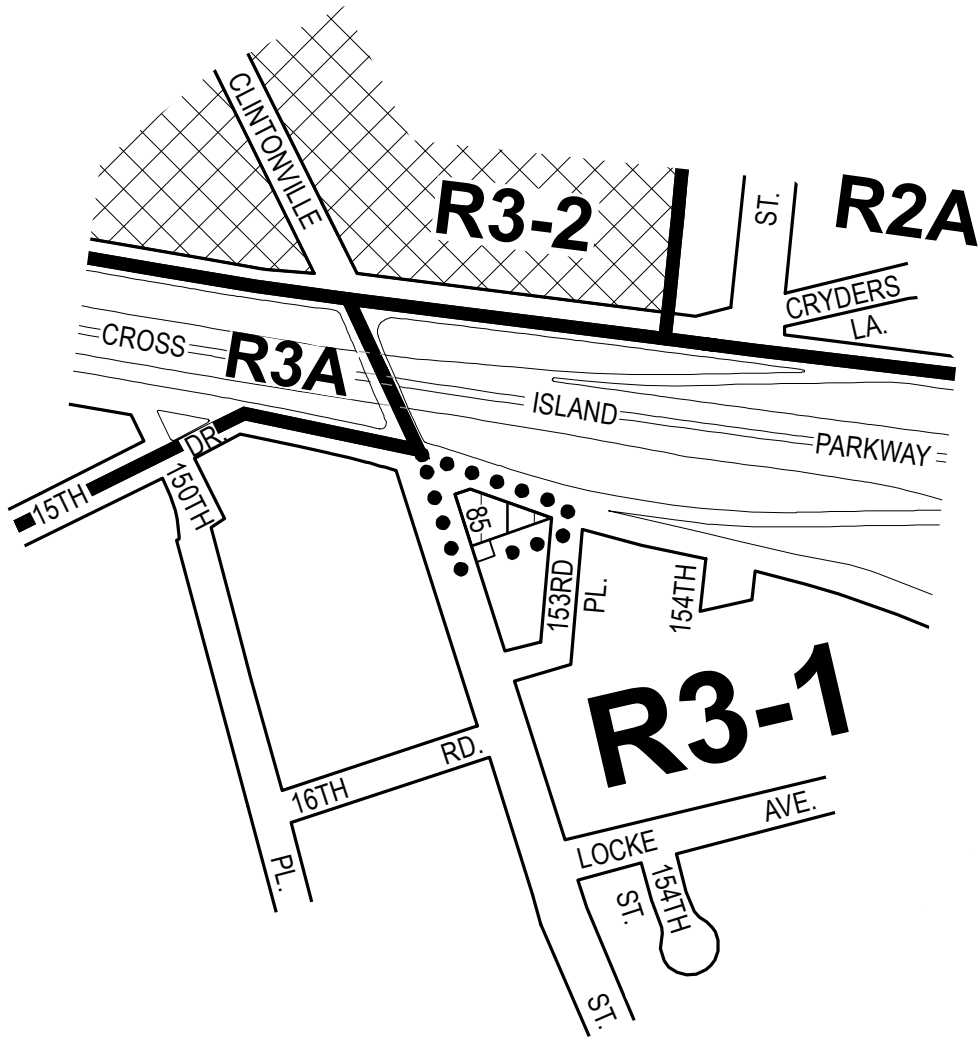

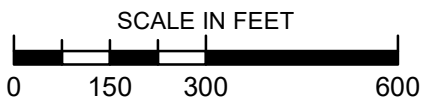

CITY PLANNING COMMISSION  
 CITY OF NEW YORK  
 DIAGRAM SHOWING PROPOSED  
**ZONING CHANGE**  
 ON SECTIONAL MAP  
**7d**  
 BOROUGH OF  
**QUEENS**

EFFECTIVE DATE
<b>October 17, 2019</b>
C. C. RESO. # 1112

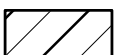

**NOTE:**

-  Indicates Zoning District Boundary
-  The area enclosed by the dotted line is rezoned by establishing a C1-3 District within an existing R3-1 District.
-  Indicates a C1-2 District
-  Indicates a C1-3 District

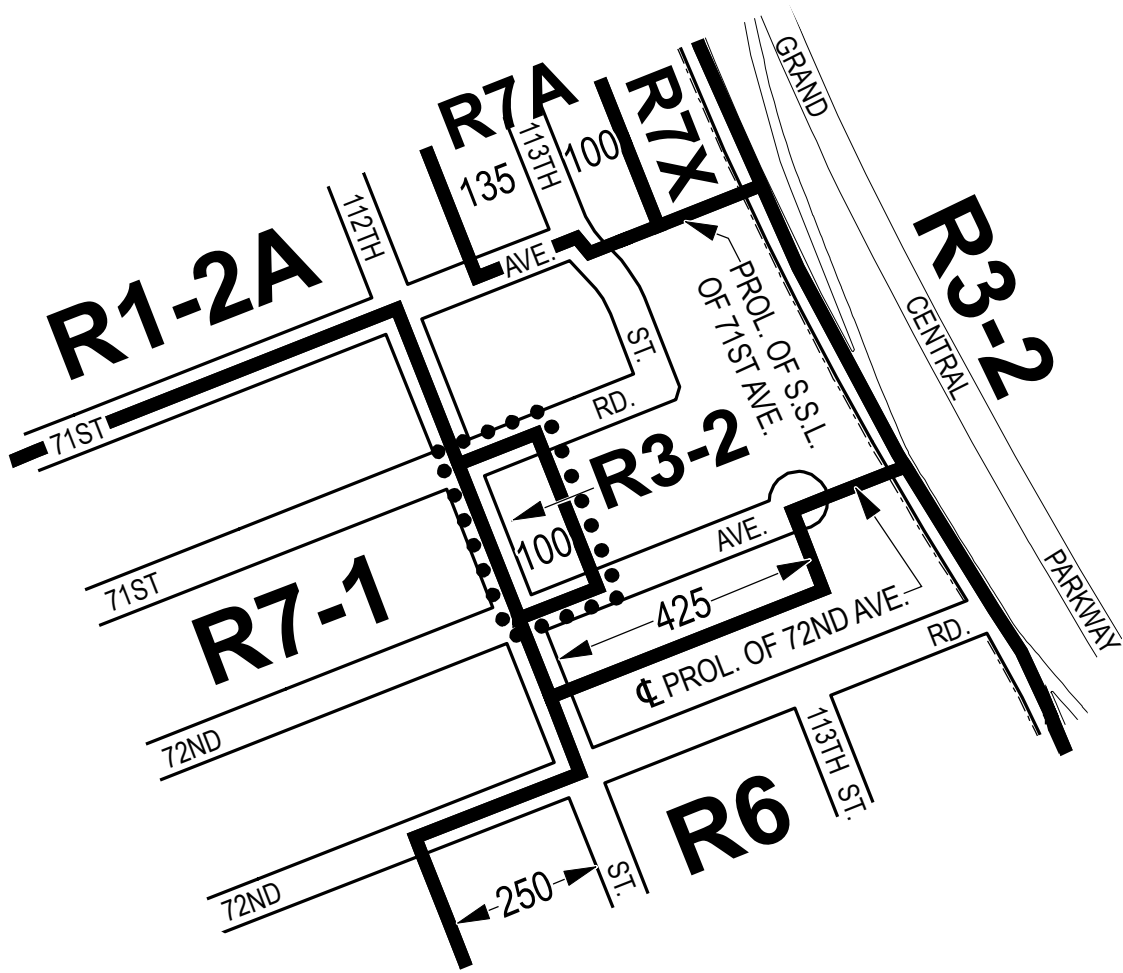

CITY PLANNING COMMISSION  
 CITY OF NEW YORK  
 DIAGRAM SHOWING  
**ZONING CHANGE**  
 ON SECTIONAL MAP  
**14a**  
 BOROUGH OF  
**QUEENS**

EFFECTIVE DATE
<b>October 17, 2019</b>
C. C. RESO. # 1113

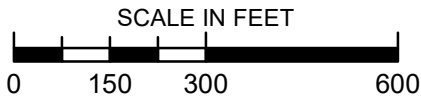

**NOTE:**

- Indicates Zoning District Boundary
- The area enclosed by the dotted line is proposed to be rezoned by changing an existing an R1-2A District to an R3-2 District.

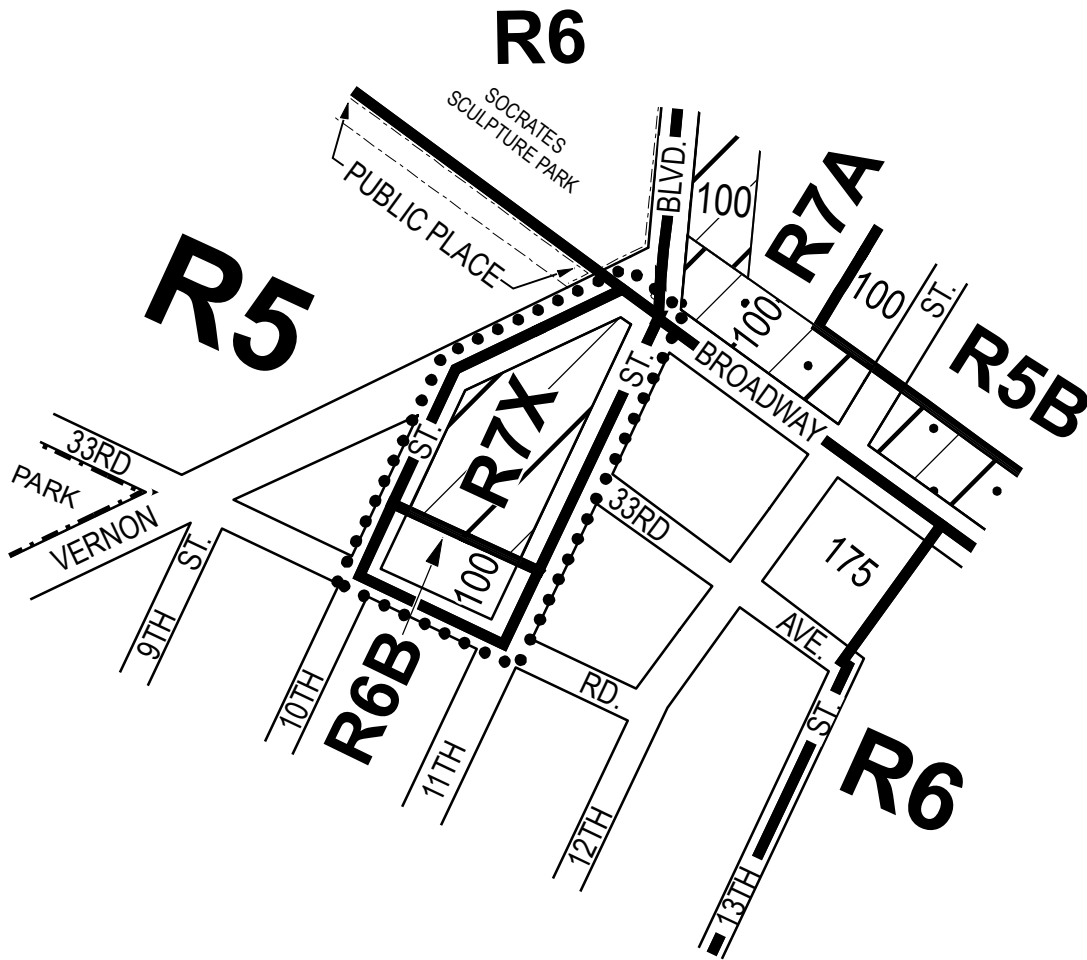



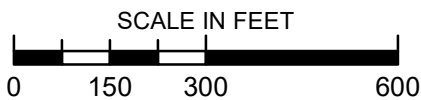

CITY PLANNING COMMISSION  
 CITY OF NEW YORK  
 DIAGRAM SHOWING  
**ZONING CHANGE**  
 ON SECTIONAL MAP

**9a**  
 BOROUGH OF  
**QUEENS**

EFFECTIVE DATE
<b>October 17, 2019</b>
C. C. RESO. # 1131



**NOTE:**

-  Indicates Zoning District Boundary
-  The area enclosed by the dotted line is rezoned by changing an existing R5 District to an R6B and R7X Districts and by establishing a C1-3 District within the proposed R7X District.
-  Indicates a C1-3 District
-  Indicates a C2-3 District

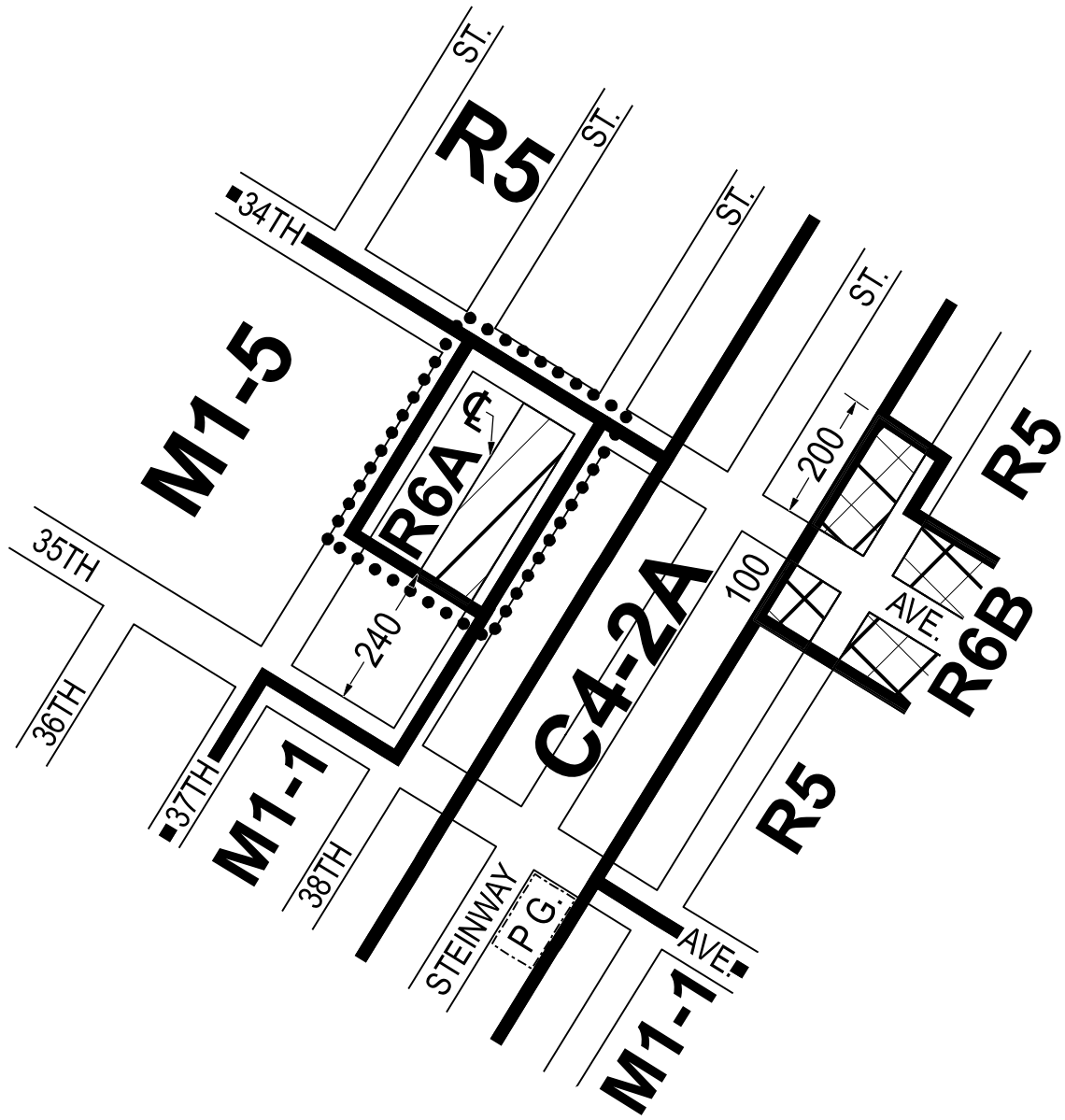



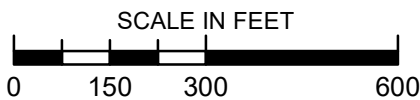

CITY PLANNING COMMISSION  
 CITY OF NEW YORK  
 DIAGRAM SHOWING  
**ZONING CHANGE**  
 ON SECTIONAL MAP  
**9b**  
 BOROUGH OF  
**QUEENS**

EFFECTIVE DATE  
**October 17, 2019**  
 C. C. RESO. # 1134

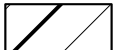

**NOTE:**

-  Indicates Zoning District Boundary
-  The area enclosed by the dotted line is rezoned by changing an existing M1-1 District to an R6A and by establishing a C1-3 District within the proposed R6A Districts.
-  Indicates a C1-3 District
-  Indicates a C1-4 District

30c|31a

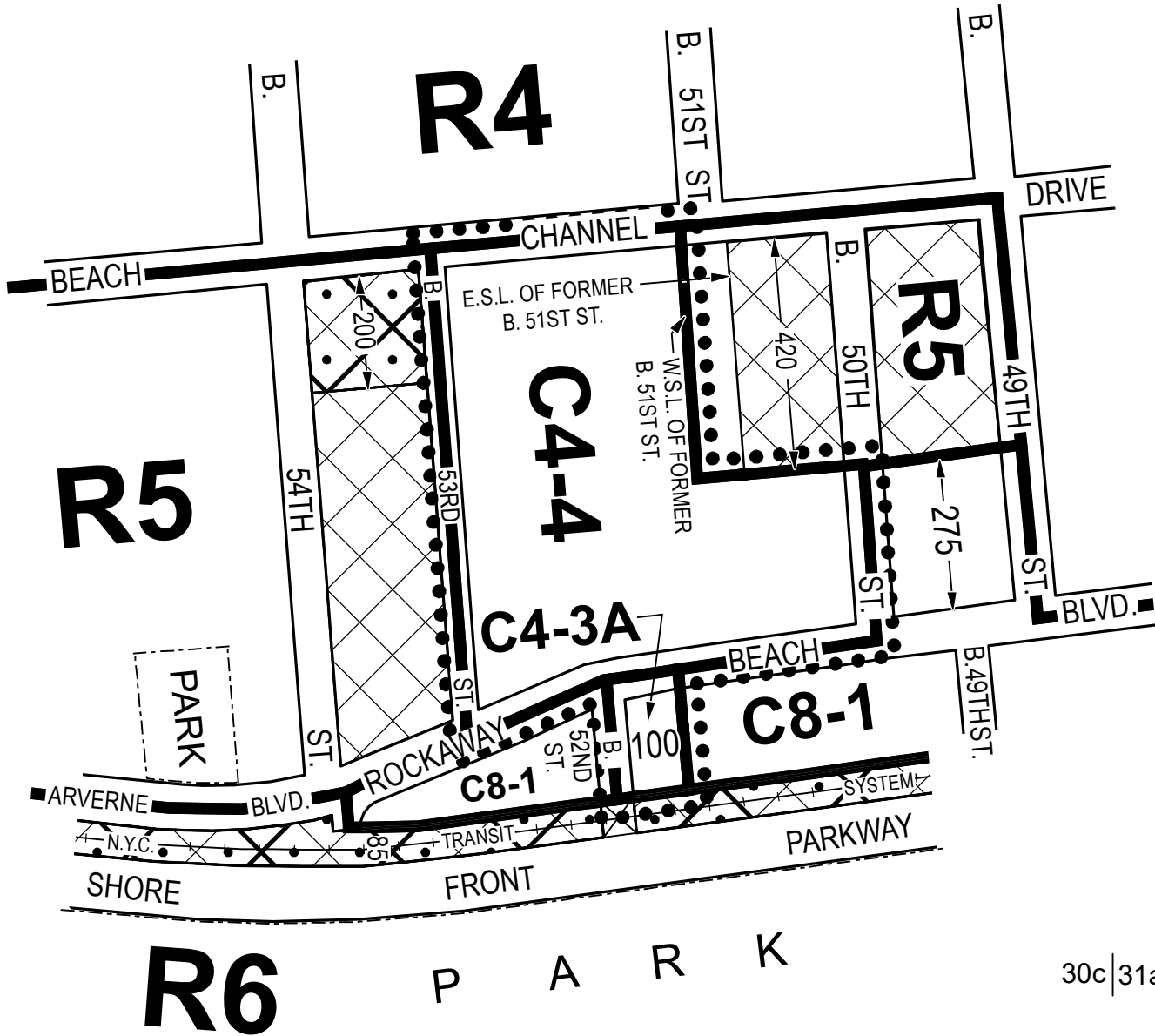



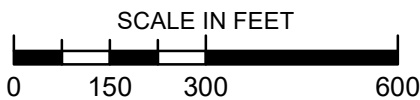

CITY PLANNING COMMISSION  
 CITY OF NEW YORK  
 DIAGRAM SHOWING  
**ZONING CHANGE**  
 ON SECTIONAL MAP  
**30c**  
 BOROUGH OF  
**QUEENS**

EFFECTIVE DATE  
**November 14, 2019**  
 C. C. RESO. # 1165



**NOTE:**

-  Indicates Zoning District Boundary
-  The area enclosed by the dotted line is rezoned by eliminating a C1-2 District from within an existing R5 District, and by changing existing R5 and C8-1 Districts to C4-4 and C4-3A Districts.
-  Indicates a C1-2 District
-  Indicates a C2-4 District

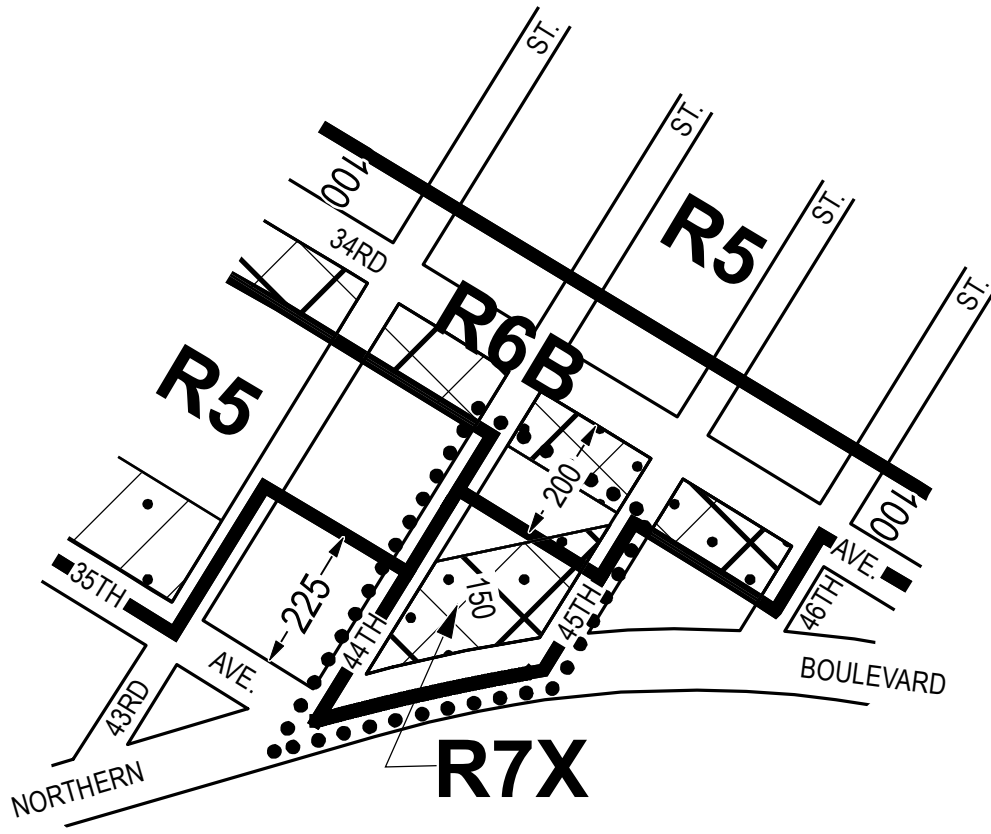

# M1-1





CITY PLANNING COMMISSION  
 CITY OF NEW YORK  
 DIAGRAM SHOWING  
**ZONING CHANGE**  
 ON SECTIONAL MAP

**9b**  
 BOROUGH OF  
**QUEENS**

EFFECTIVE DATE
<b>November 14, 2019</b>
C. C. RESO. # 1170



**NOTE:**

-  Indicates Zoning District Boundary
-  The area enclosed by the dotted line is rezoned by changing from an existing M1-1 District to R6B and R7X Districts and by establishing C2-4 Districts with the proposed R6B and R7X Districts.
-  Indicates a C1-4 District
-  Indicates a C2-1 District
-  Indicates a C2-4 District

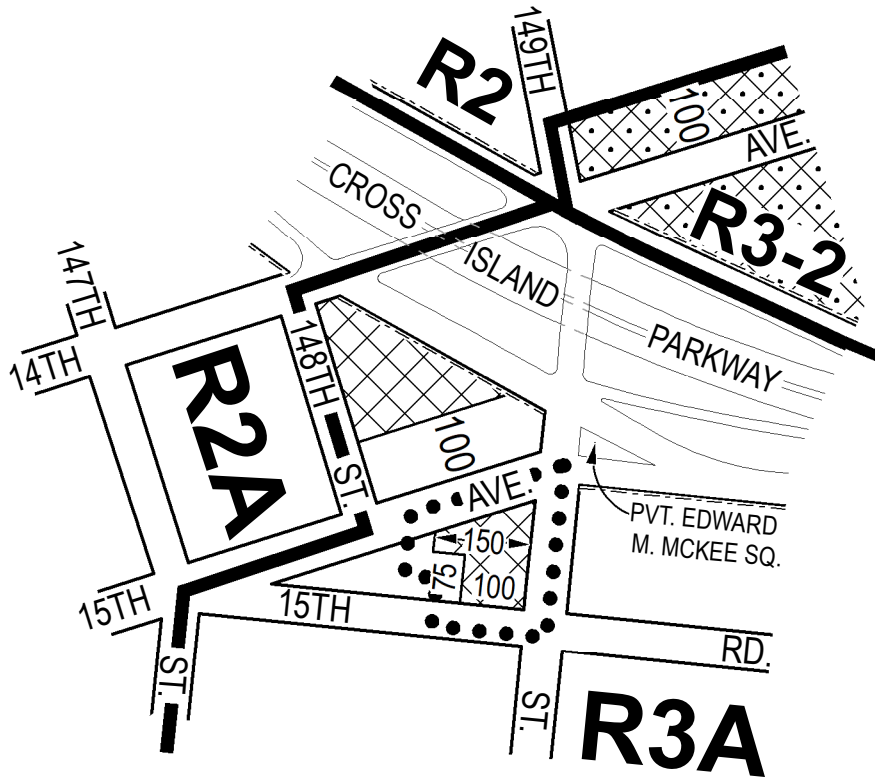





CITY PLANNING COMMISSION  
 CITY OF NEW YORK  
 DIAGRAM SHOWING  
**ZONING CHANGE**  
 ON SECTIONAL MAP  
**7d**  
 BOROUGH OF  
**QUEENS**

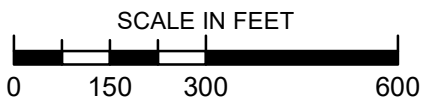

EFFECTIVE DATE  
**February 11, 2020**  
 C. C. RESO. # 1249



**NOTE:**

-  Indicates Zoning District Boundary
-  The area enclosed by the dotted line is rezoned by establishing a C1-2 District within an existing R3A District.
-  Indicates a C1-2 District
-  Indicates a C2-2 District



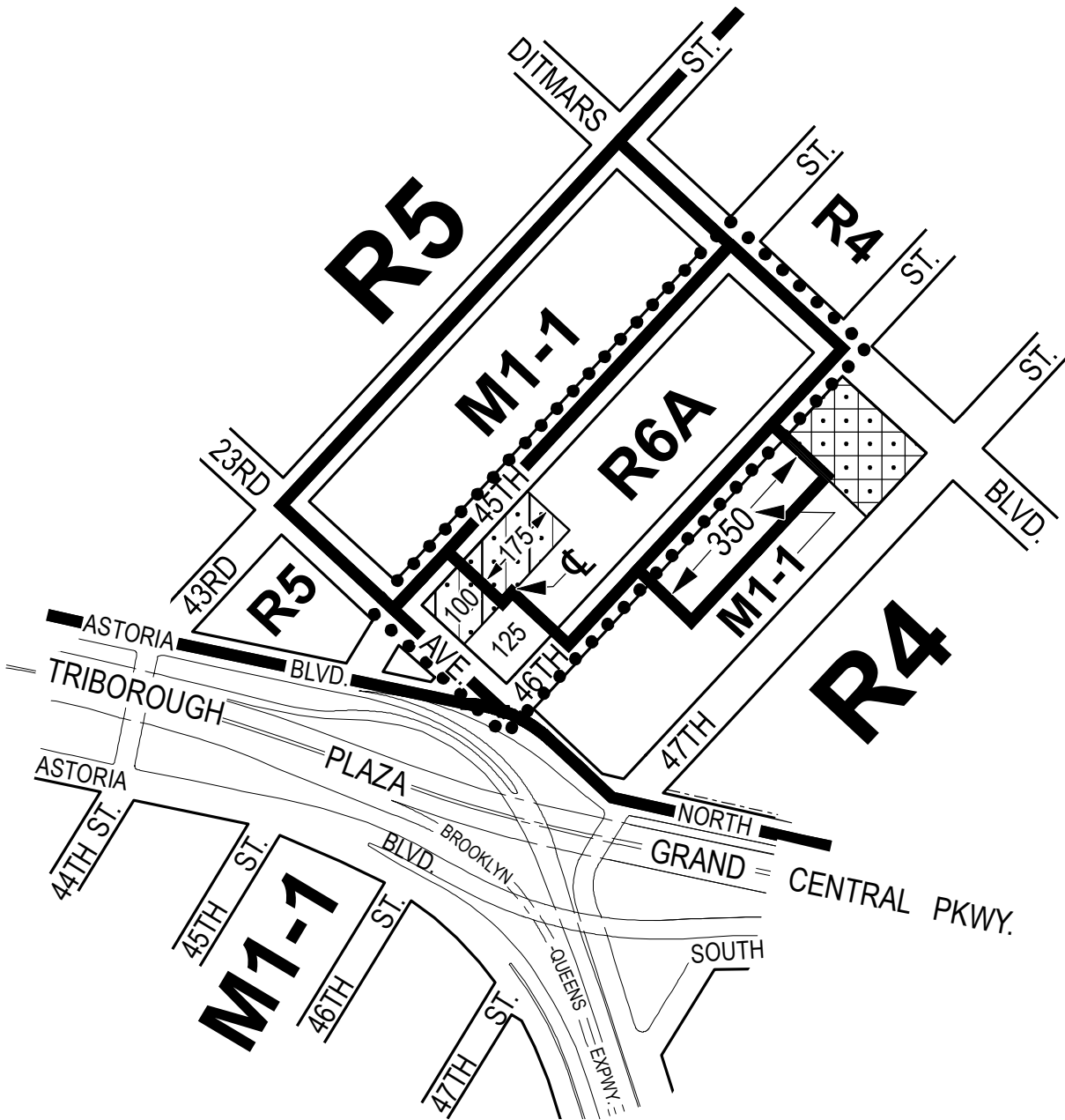



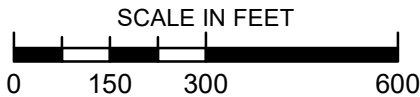

CITY PLANNING COMMISSION  
 CITY OF NEW YORK  
 DIAGRAM SHOWING  
**ZONING CHANGE**  
 ON SECTIONAL MAP  
**9c**  
 BOROUGH OF  
**QUEENS**

EFFECTIVE DATE  
**February 11, 2020**  
 C. C. RESO. # 1252



**NOTE:**

-  Indicates Zoning District Boundary
-  The area enclosed by the dotted line is rezoned by changing an existing M1-1 District to an R4 District, existing R4 and M1-1 Districts to an R6A District, and by establishing C2-3 Districts within the proposed R4 and R6A Districts.
-  Indicates a C2-2 District
-  Indicates a C2-3 District

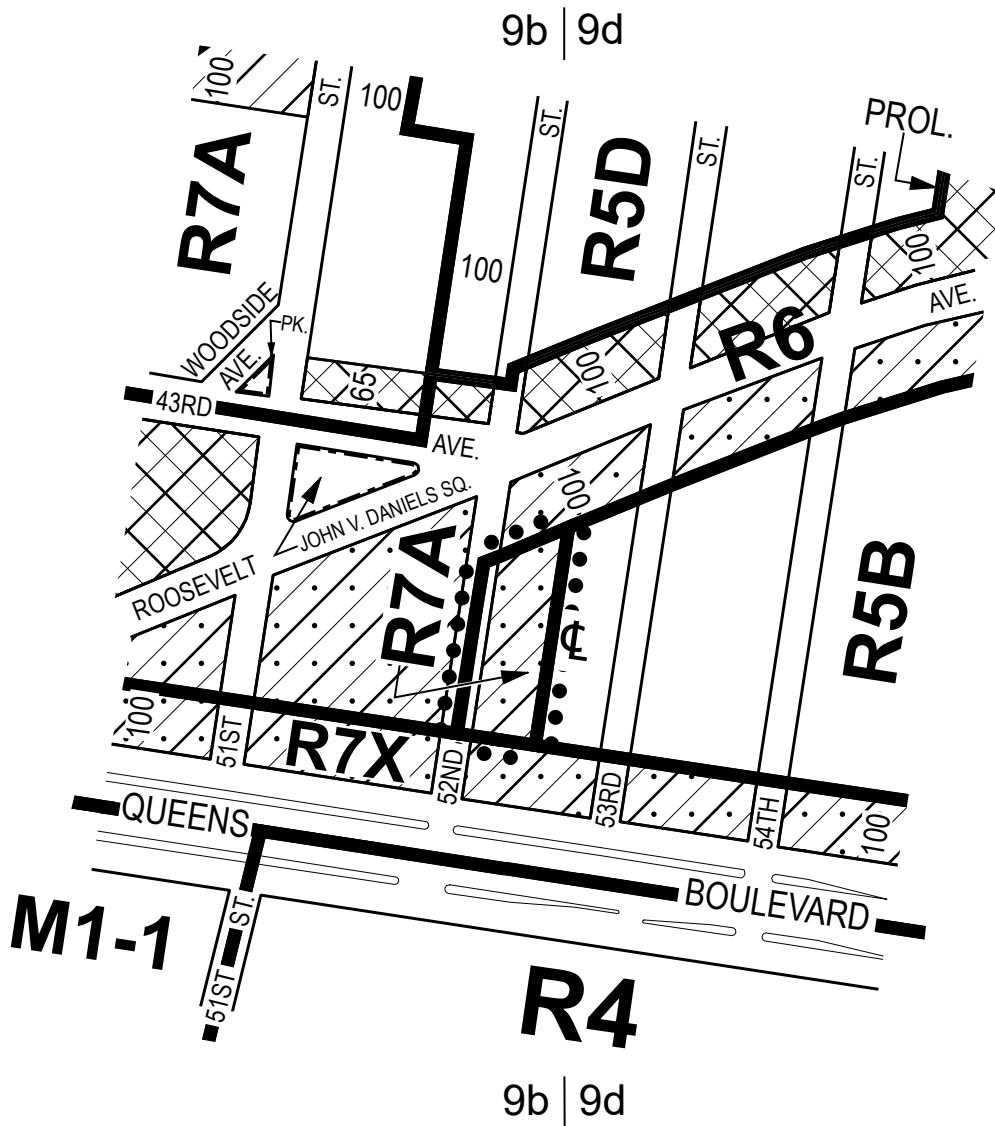



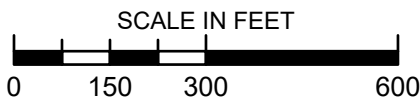

CITY PLANNING COMMISSION  
 CITY OF NEW YORK  
 DIAGRAM SHOWING PROPOSED  
**ZONING CHANGE**  
 ON SECTIONAL MAP  
**9b & 9d**  
 BOROUGH OF  
**QUEENS**

EFFECTIVE DATE  
**August 27, 2020**  
 C. C. RESO.#1413

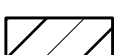

**NOTE:**

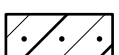
-  Indicates Zoning District Boundary
-  The area enclosed by the dotted line is rezoned by changing an existing R5B District to an R7A District and establishing a C2-3 District within the proposed R7A District.
-  Indicates a C1-3 District
-  Indicates a C1-4 District
-  Indicates a C2-3 District

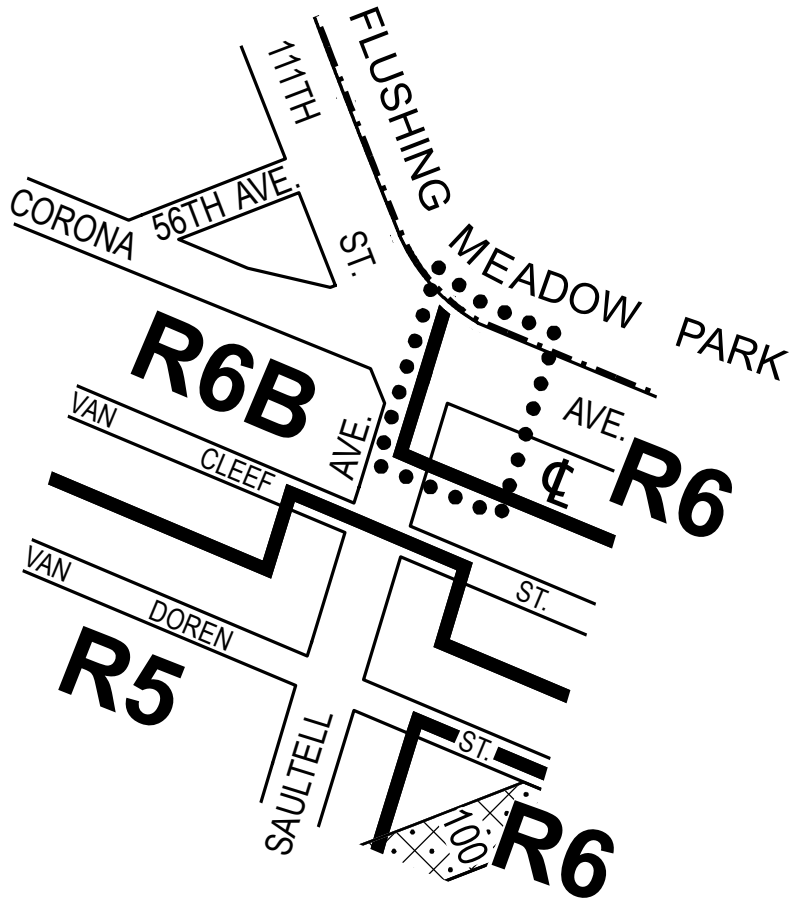

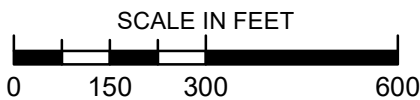

CITY PLANNING COMMISSION  
 CITY OF NEW YORK  
 DIAGRAM SHOWING  
**ZONING CHANGE**  
 ON SECTIONAL MAP  
**10b**  
 BOROUGH OF  
**QUEENS**



EFFECTIVE DATE  
**November 19, 2020**  
 C. C. RESO. # 1493

**NOTE:**

-  Indicates Zoning District Boundary
-  The area enclosed by the dotted line is rezoned by changing an existing R6B District to an R6 District.
-  Indicates a C2-2 District

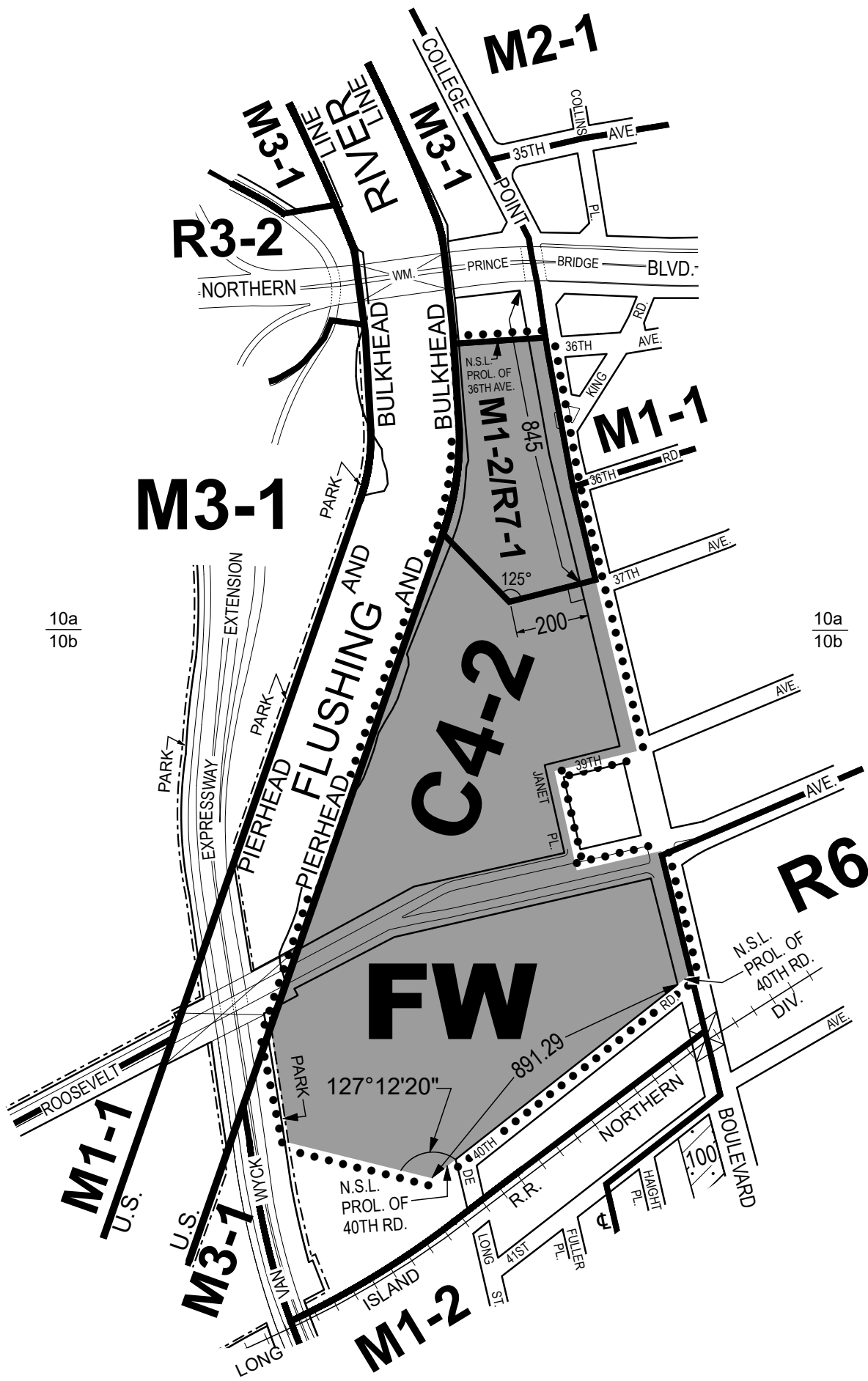

CITY PLANNING COMMISSION  
 CITY OF NEW YORK  
 DIAGRAM SHOWING  
**ZONING CHANGE**  
 ON SECTIONAL MAP  
**10a & 10b**  
 BOROUGH OF  
**QUEENS**

EFFECTIVE DATE
<b>December 10, 2020</b>
C. C. RESO.#1502

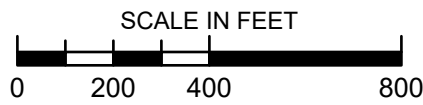

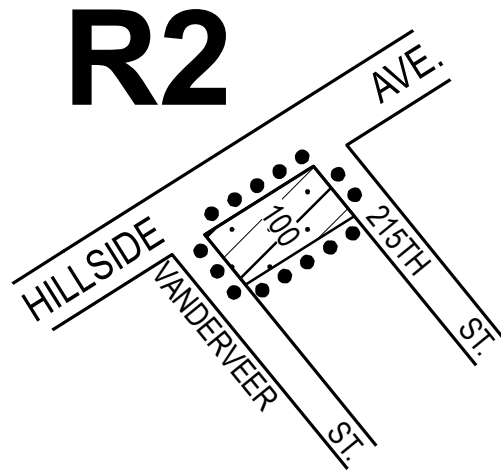

- NOTE:**
- Indicates Zoning District Boundary
  - The area enclosed by the dotted line is proposed to be rezoned by changing existing C4-2 and M3-1 Districts to an M1-2/R7-1 District and by establishing a Special Flushing Waterfront District (FW).
  - Indicates a C2-3 District
  - Indicates a Special Flushing Waterfront District (FW).

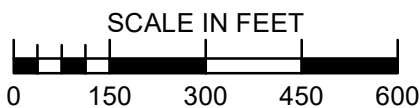

CITY PLANNING COMMISSION  
 CITY OF NEW YORK  
 DIAGRAM SHOWING  
**ZONING CHANGE**  
 ON SECTIONAL MAP  
**15a**  
 BOROUGH OF  
**QUEENS**



EFFECTIVE DATE
<b>February 25, 2020</b>
C. C. RESO.#1557

- NOTE:**
-  Indicates Zoning District Boundary
  -  The area enclosed by the dotted line is rezoned by establishing a C2-3 District within an existing R2 District.
  -  Indicates a C2-3 District

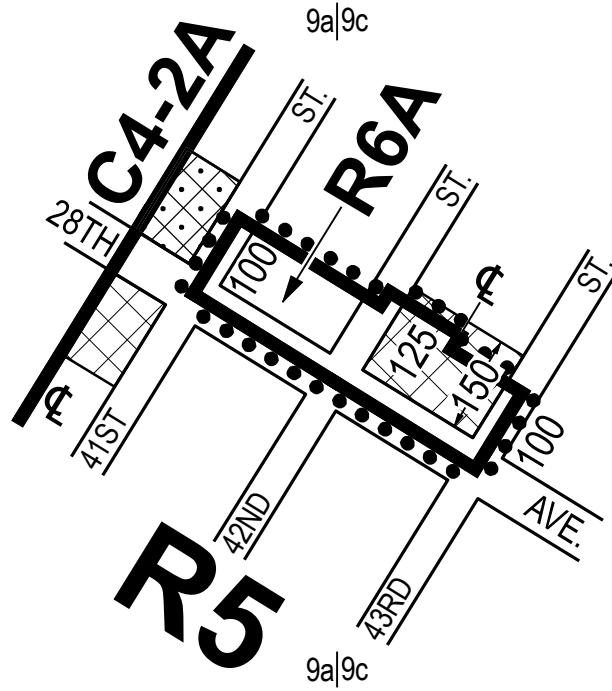





CITY PLANNING COMMISSION  
 CITY OF NEW YORK  
 DIAGRAM SHOWING  
**ZONING CHANGE**  
 ON SECTIONAL MAP  
**9a & 9c**  
 BOROUGH OF  
**QUEENS**

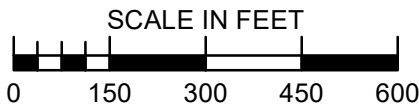

EFFECTIVE DATE  
**February 25, 2021**  
 C. C. RESO.#1560

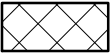

**NOTE:**

-  Indicates Zoning District Boundary
-  The area enclosed by the dotted line is rezoned by changing an existing R5 District to an R6A District.
-  Indicates a C1-2 District
-  Indicates a C2-2 District

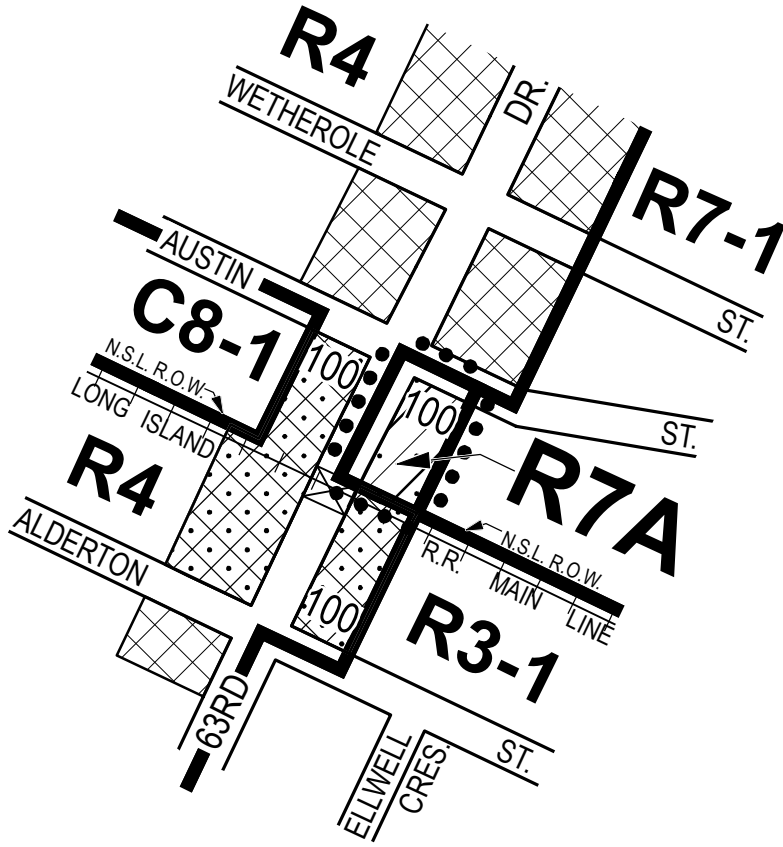





CITY PLANNING COMMISSION  
 CITY OF NEW YORK  
 DIAGRAM SHOWING  
**ZONING CHANGE**  
 ON SECTIONAL MAP  
**14a**  
 BOROUGH OF  
**QUEENS**

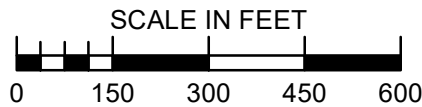

EFFECTIVE DATE  
**March 18, 2021**  
 C. C. RESO.#1573

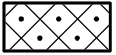

**NOTE:**

-  Indicates Zoning District Boundary
-  The area enclosed by the dotted line is rezoned by eliminating a C2-2 District from R4 District, changing an R4 District to an R7A District, and by establishing a C2-3 District within the proposed R7A District.
-  Indicates a C1-2 District
-  Indicates a C2-2 District
-  Indicates a C2-3 District

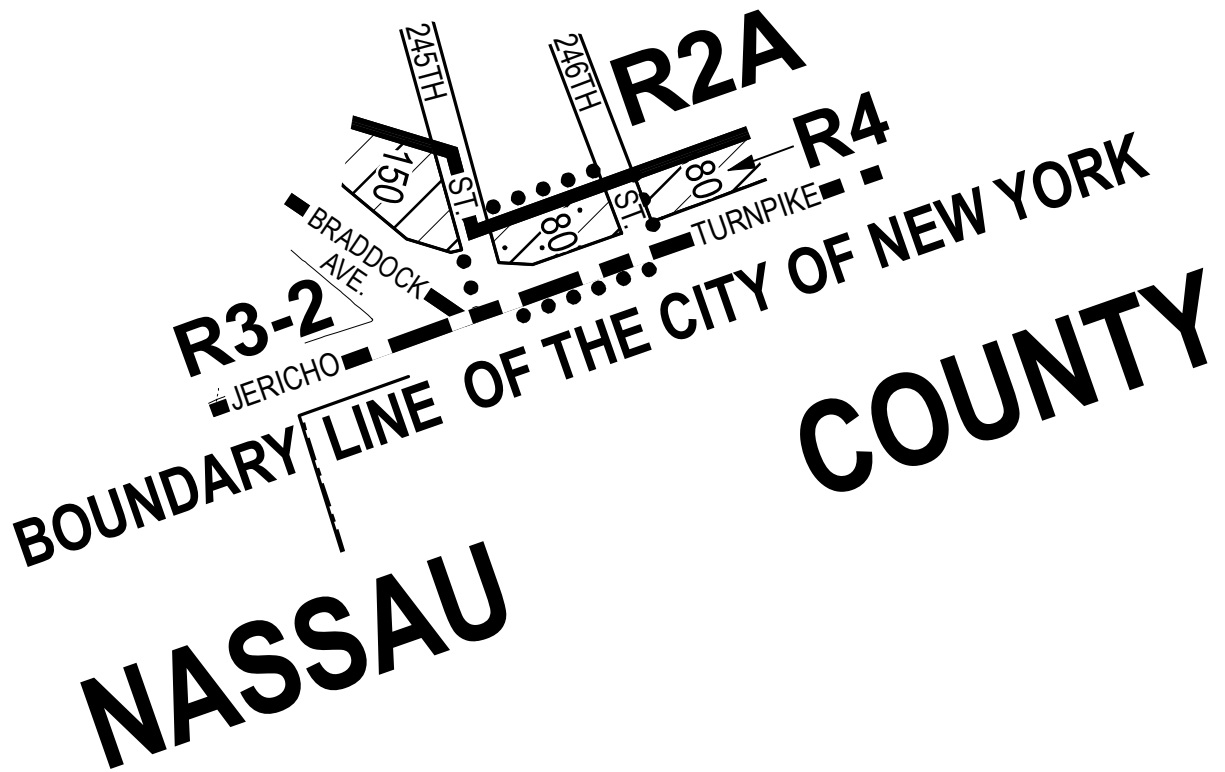

CITY PLANNING COMMISSION  
 CITY OF NEW YORK  
 DIAGRAM SHOWING  
**ZONING CHANGE**  
 ON SECTIONAL MAP  
**15c**  
 BOROUGH OF  
**QUEENS**



EFFECTIVE DATE  
**March 18, 2021**  
 C. C. RESO.#1575

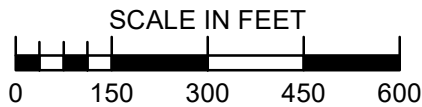

**NOTE:**

- Indicates Zoning District Boundary
- The area enclosed by the dotted line is rezoned by changing from an existing C1-3 District to a C2-3 District.

Indicates a C1-3 District

Indicates a C2-3 District



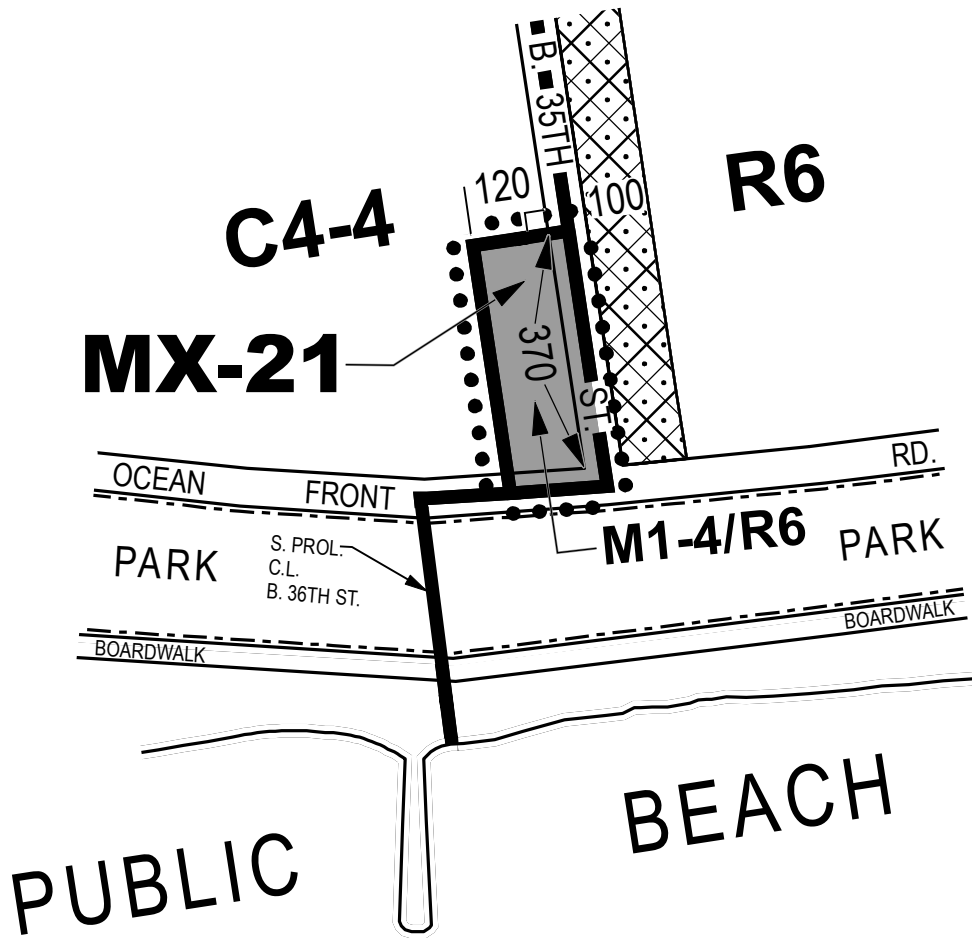

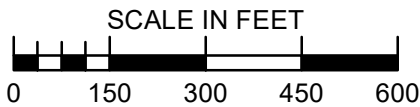

CITY PLANNING COMMISSION  
 CITY OF NEW YORK  
 DIAGRAM SHOWING  
**ZONING CHANGE**  
 ON SECTIONAL MAP  
**31a**  
 BOROUGH OF  
**QUEENS**

EFFECTIVE DATE  
**March 25, 2021**  
 C. C. RESO.#1586

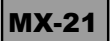

**NOTE:**

-  Indicates Zoning District Boundary
-  The area enclosed by the dotted line is rezoned by changing an existing C4-4 District to an M1-4/R6 District and by establishing a Special Mixed Use District (MX-21).
-  Indicates a C2-4 District
-  Indicates a Special Mixed Use District (**MX-21**)

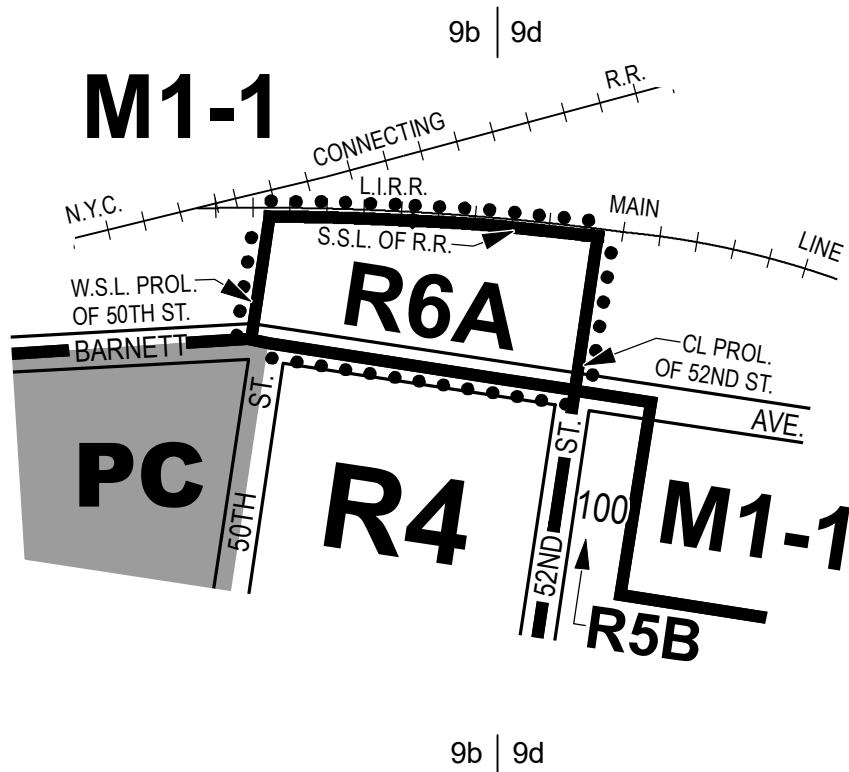

CITY PLANNING COMMISSION  
 CITY OF NEW YORK  
 DIAGRAM SHOWING  
**ZONING CHANGE**  
 ON SECTIONAL MAP  
**9b & 9d**  
 BOROUGH OF  
**QUEENS**

EFFECTIVE DATE  
**March 25, 2021**  
 C. C. RESO.#1594

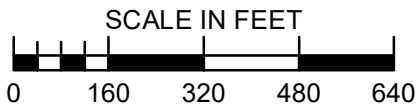

**NOTE:**

- Indicates Zoning District Boundary
- The area enclosed by the dotted line is rezoned by changing from an M1-1 District to an R6A District.
- Indicates a Special Planned Community Preservation District

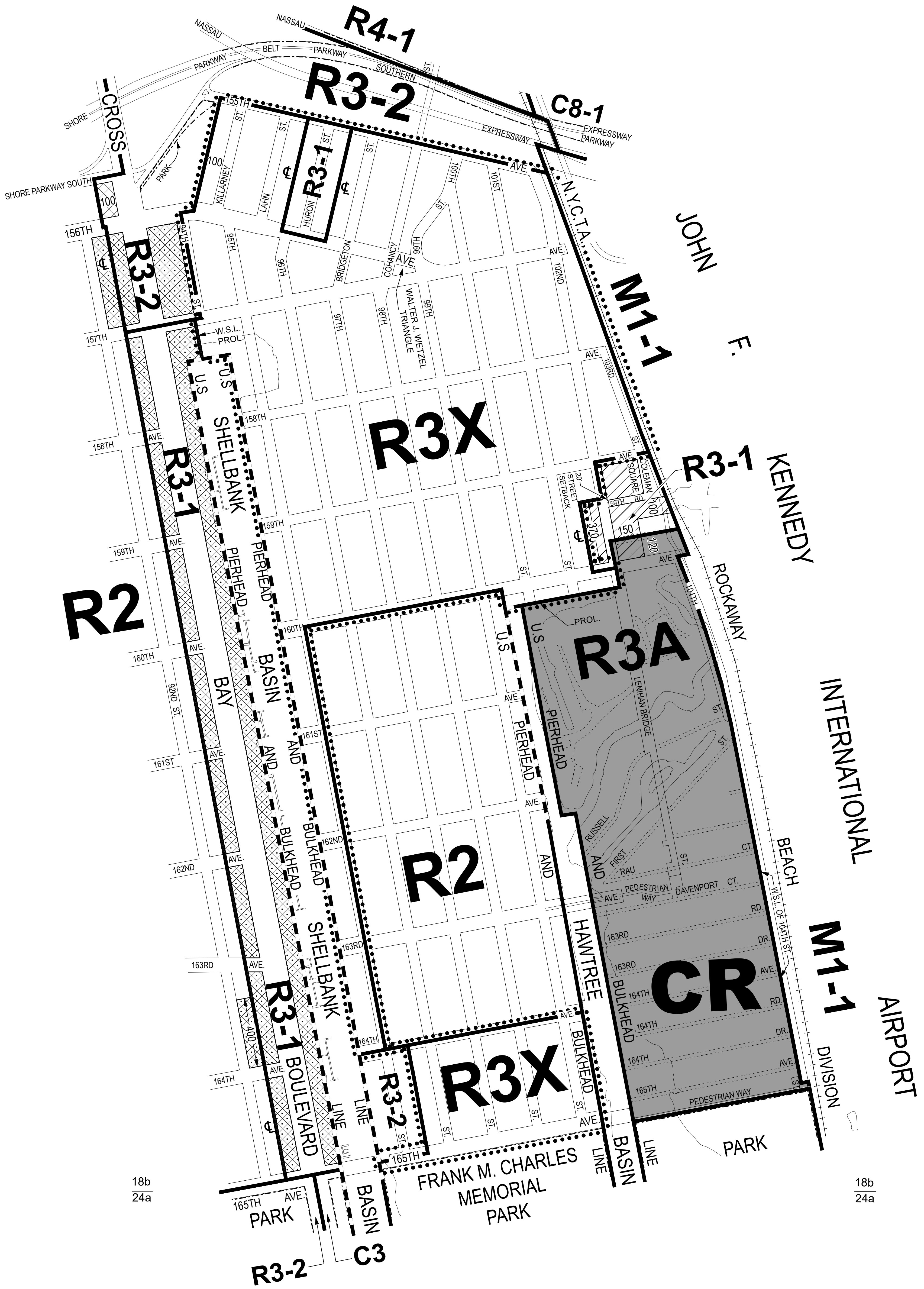

18b  
24a

18b  
24a

CITY PLANNING COMMISSION  
 CITY OF NEW YORK  
 DIAGRAM SHOWING  
**ZONING CHANGE**  
 ON SECTIONAL MAP  
**18b**  
 BOROUGH OF  
**QUEENS**

EFFECTIVE DATE  
**May 12, 2021**  
 C. C. RESO. # 1627

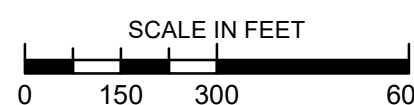

- NOTE:**
- Indicates Zoning District Boundary
  - ..... The area enclosed by the dotted line is rezoned by changing R3-1 and R3-2 Districts to an R3X District, and by changing an R3-2 District to an R3-1 District.
  - ▨ Indicates a C1-2 District
  - ▧ Indicates a C1-3 District
  - ▩ Indicates a C2-2 District
  - CR** Indicates a Special Coastal Risk District (CR).

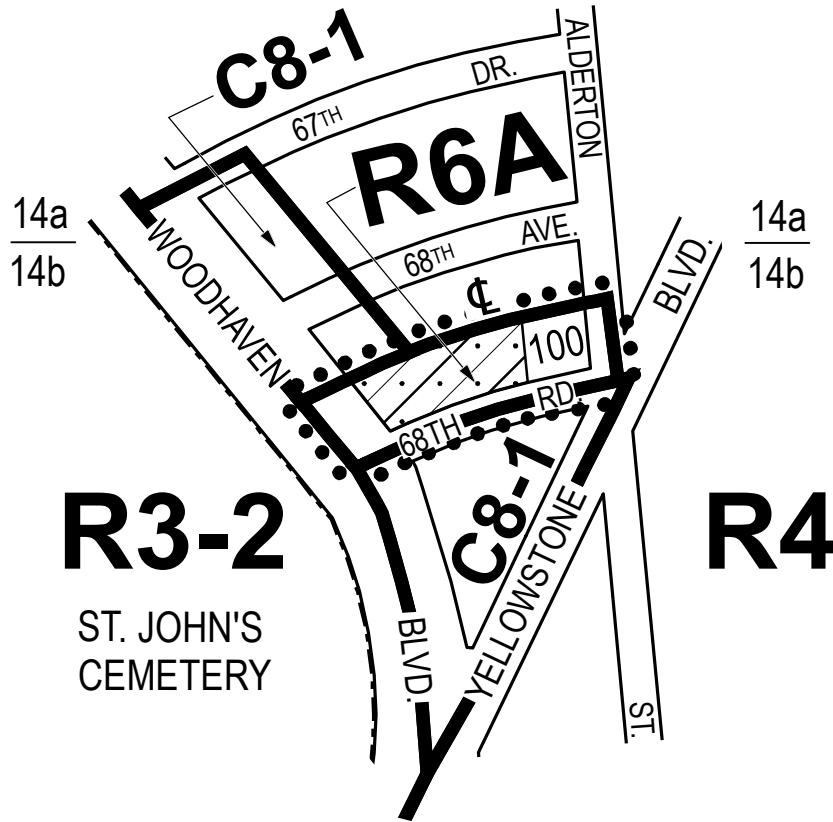

CITY PLANNING COMMISSION  
 CITY OF NEW YORK  
 DIAGRAM SHOWING  
**ZONING CHANGE**  
 ON SECTIONAL MAP  
**14b**  
 BOROUGH OF  
**QUEENS**

EFFECTIVE DATE <b>May 12, 2021</b> C. C. RESO.#1638
---

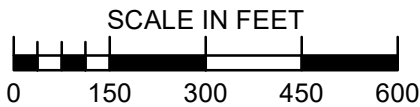

**NOTE:**

- Indicates Zoning District Boundary
- The area enclosed by the dotted line is rezoned by changing existing R4 and C8-1 Districts to an R6A District, and by establishing a C2-3 District within the proposed R6A District.
- Indicates a C2-3 District

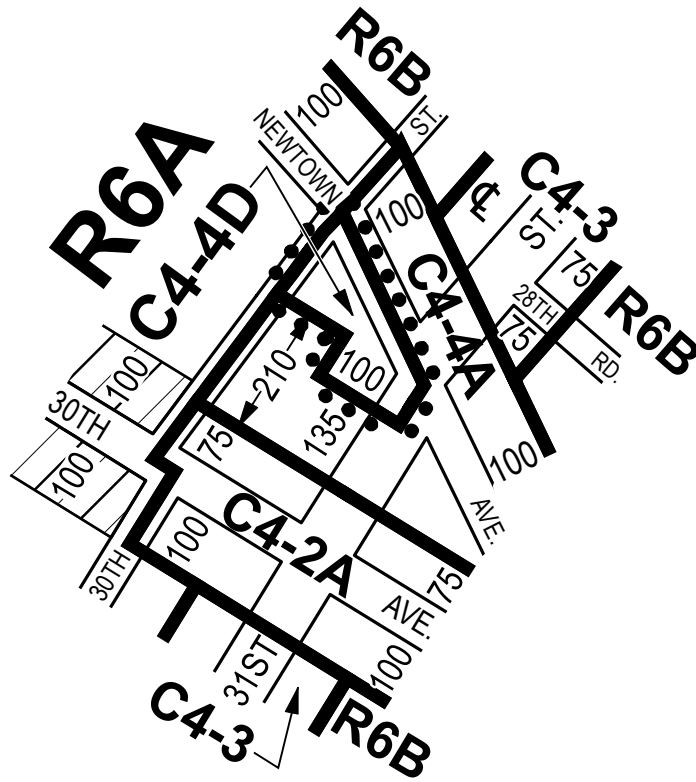

CITY PLANNING COMMISSION  
 CITY OF NEW YORK  
 DIAGRAM SHOWING  
**ZONING CHANGE**  
 ON SECTIONAL MAP

**9a**  
 BOROUGH OF  
**QUEENS**

EFFECTIVE DATE  
**June 17, 2021**  
 C. C. RESO.#1689

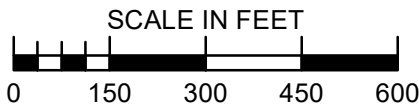

**NOTE:**

- Indicates Zoning District Boundary
- The area enclosed by the dotted line is rezoned by changing an existing C4-4A District to a C4-4D District.
- Indicates a C1-3 District

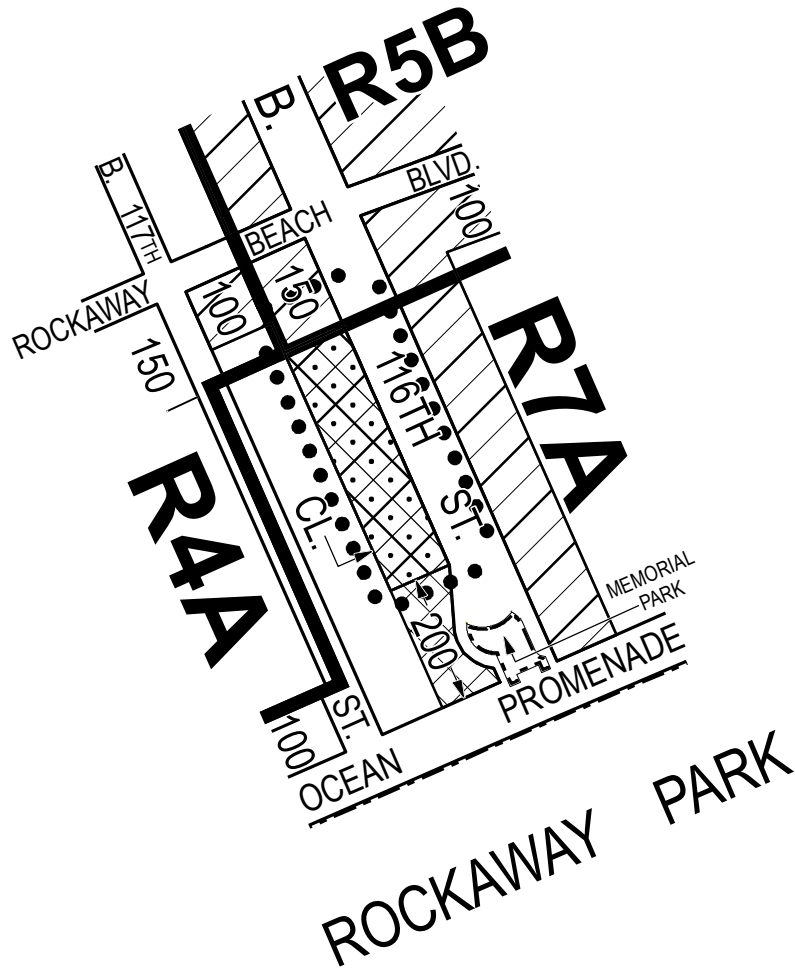



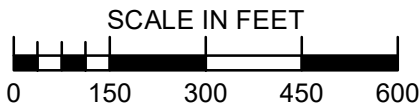

CITY PLANNING COMMISSION  
 CITY OF NEW YORK  
 DIAGRAM SHOWING  
**ZONING CHANGE**  
 ON SECTIONAL MAP  
**30b**  
 BOROUGH OF  
**QUEENS**

EFFECTIVE DATE  
**August 26, 2021**  
 C. C. RESO.#1734



**NOTE:**

-  Indicates Zoning District Boundary
-  The area enclosed by the dotted line is rezoned by eliminating a C1-3 District from within an existing R7A District and by establishing a C2-4 District within the existing R7A District.
-  Indicates a C1-2 District
-  Indicates a C1-3 District
-  Indicates a C2-4 District

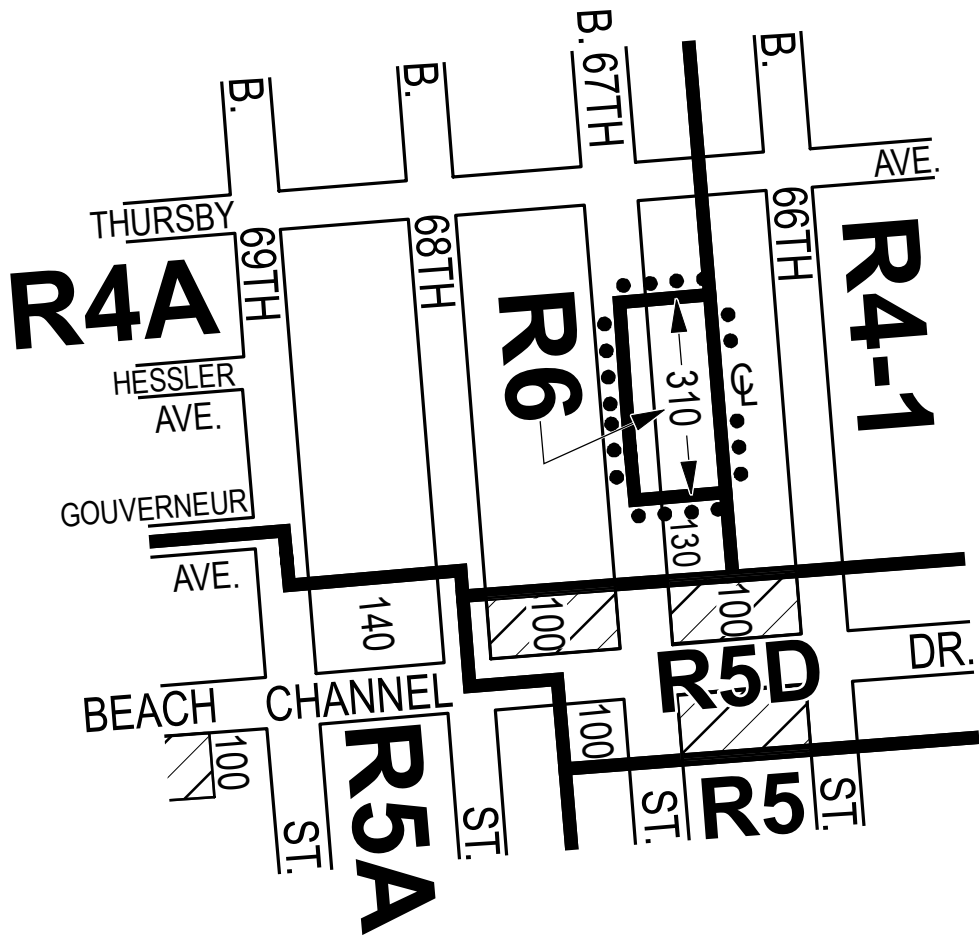

CITY PLANNING COMMISSION  
 CITY OF NEW YORK  
 DIAGRAM SHOWING  
**ZONING CHANGE**  
 ON SECTIONAL MAP  
**30c**  
 BOROUGH OF  
**QUEENS**



EFFECTIVE DATE  
**August 26, 2021**  
 C. C. RESO.#1735

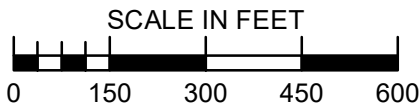

- NOTE:**
- Indicates Zoning District Boundary
  - The area enclosed by the dotted line is rezoned by changing an R4A District to an R6 District.
  - Indicates a C1-3 District

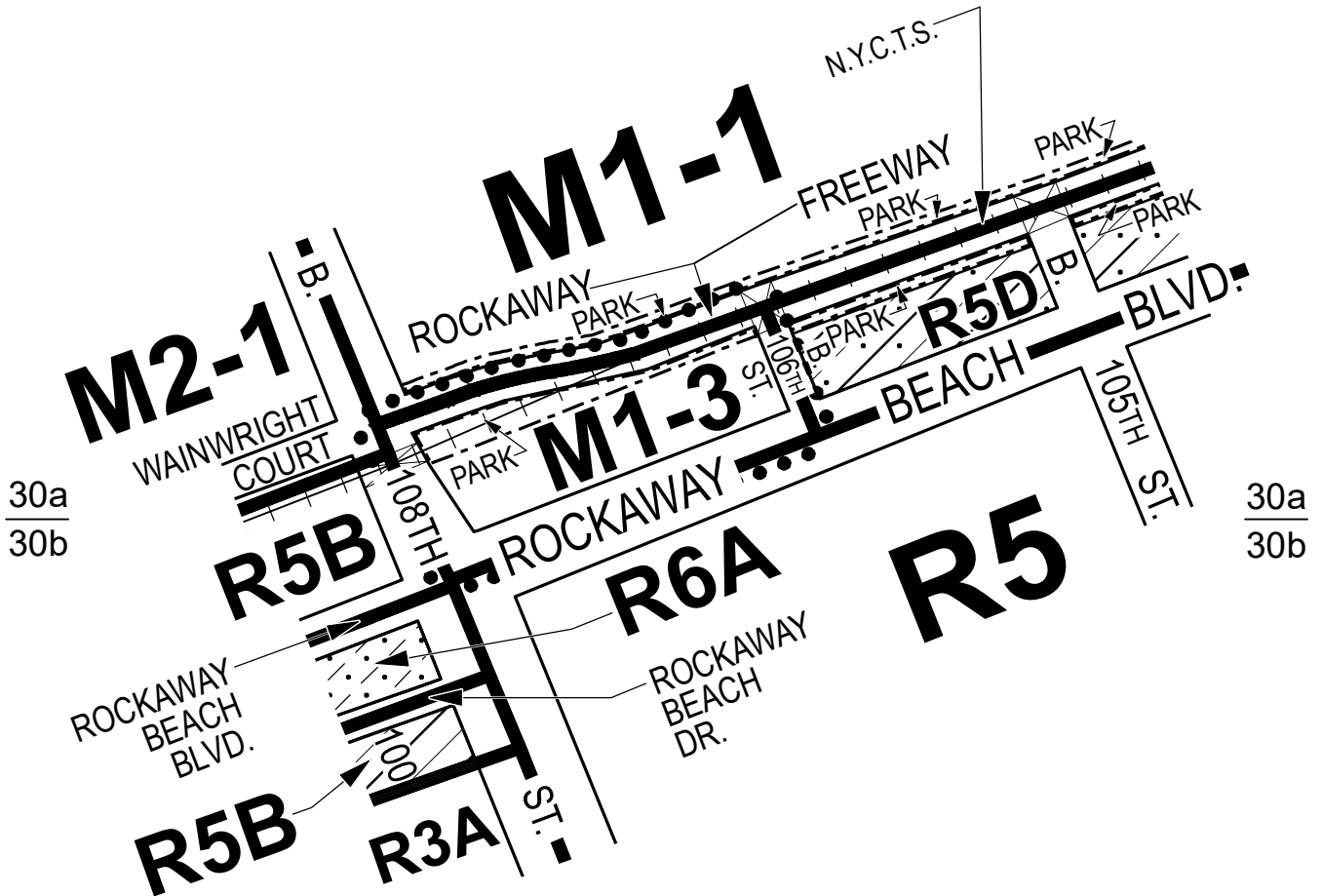





CITY PLANNING COMMISSION  
 CITY OF NEW YORK  
 DIAGRAM SHOWING  
**ZONING CHANGE**  
 ON SECTIONAL MAP  
**30a & 30b**  
 BOROUGH OF  
**QUEENS**

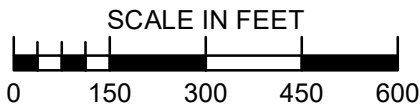

EFFECTIVE DATE  
**October 7, 2021**  
 C. C. RESO.#1757

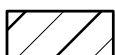

**NOTE:**

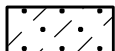
-  Indicates Zoning District Boundary
-  The area enclosed by the dotted line is rezoned by eliminating an existing C2-3 District from an existing R5D District and by changing an R5D District to an M1-3 District.
-  Indicates a C1-3 District
-  Indicates a C2-3 District
-  Indicates a C2-5 District



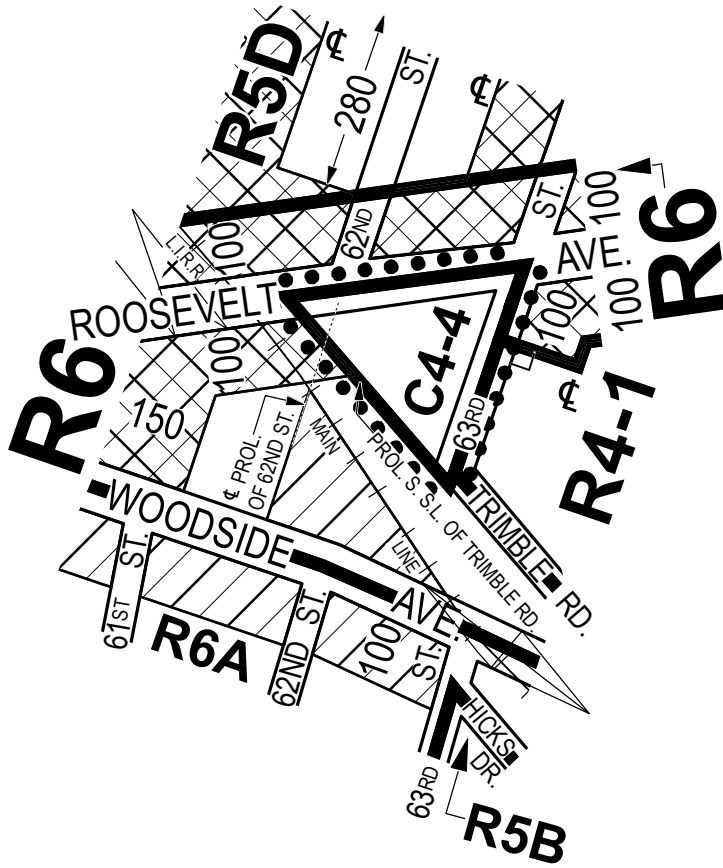

CITY PLANNING COMMISSION  
 CITY OF NEW YORK  
 DIAGRAM SHOWING  
**ZONING CHANGE**  
 ON SECTIONAL MAP  
**9d**  
 BOROUGH OF  
**QUEENS**



EFFECTIVE DATE  
**October 21, 2021**  
 C. C. RESO.#1768

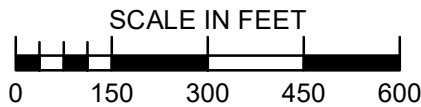

**NOTE:**

- Indicates Zoning District Boundary
- The area enclosed by the dotted line is rezoned by eliminating from within an existing R6 District a C1-4 District and by changing from an R6 District to a C4-4 District.
- Indicates a C1-3 District
- Indicates a C1-4 District

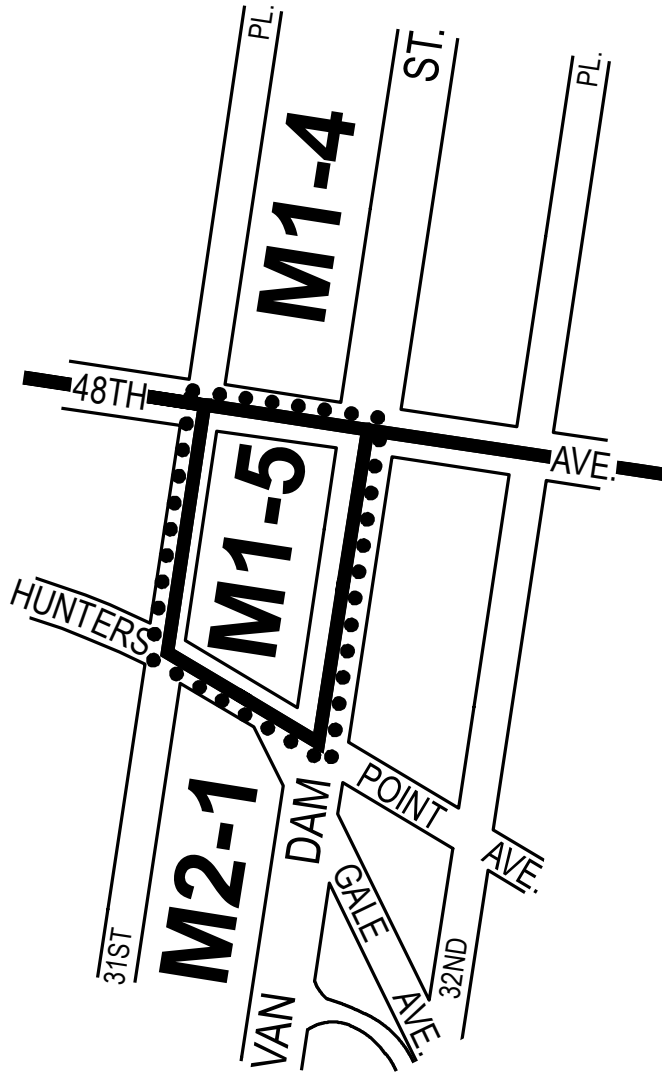

CITY PLANNING COMMISSION  
 CITY OF NEW YORK  
 DIAGRAM SHOWING  
**ZONING CHANGE**  
 ON SECTIONAL MAP  
**9b**  
 BOROUGH OF  
**QUEENS**

EFFECTIVE DATE
<b>October 21, 2021</b>
C. C. RESO. # 1775

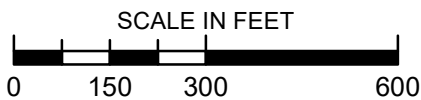

- NOTE:**
- Indicates Zoning District Boundary
  - The area enclosed by the dotted line is rezoned by changing an M2-1 District to an M1-5 District.

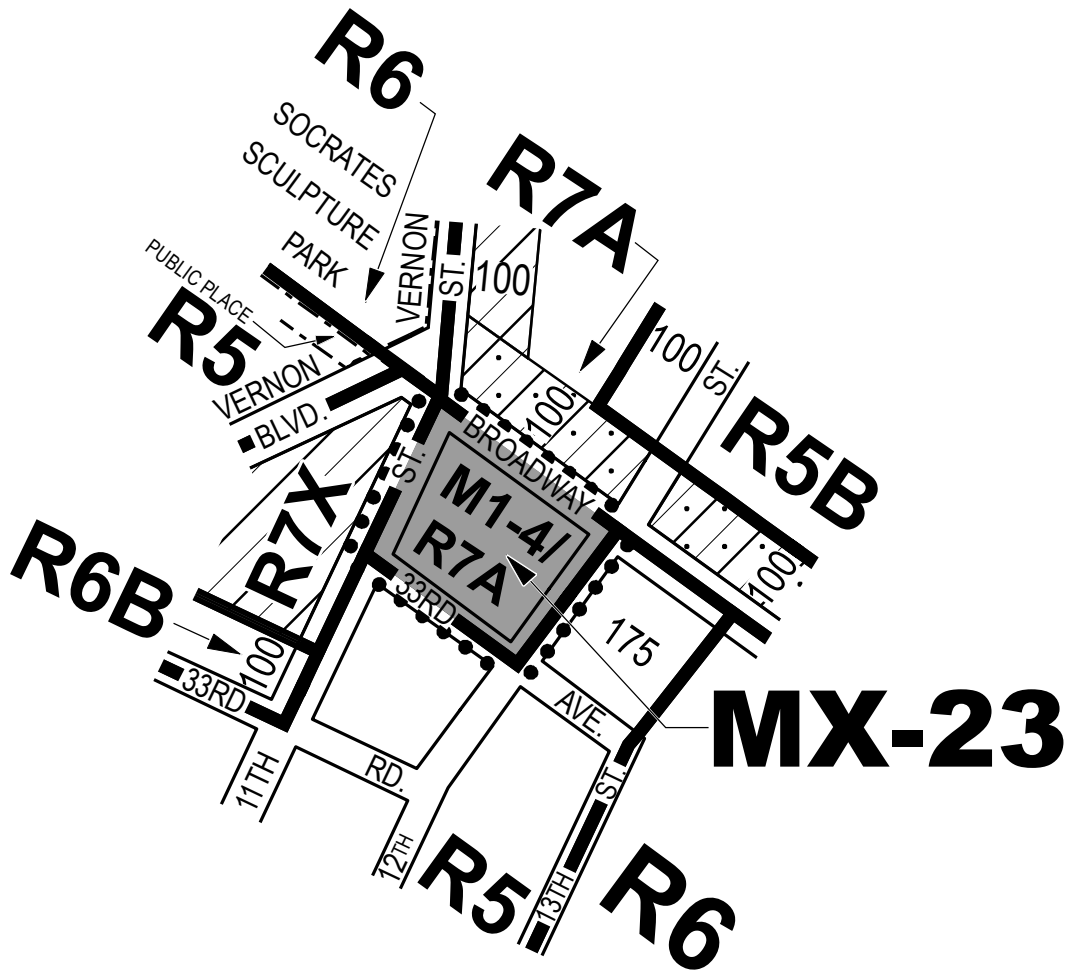



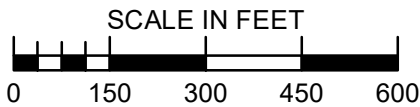

CITY PLANNING COMMISSION  
 CITY OF NEW YORK  
 DIAGRAM SHOWING  
**ZONING CHANGE**  
 ON SECTIONAL MAP

**9a**  
 BOROUGH OF  
**QUEENS**

EFFECTIVE DATE  
**October 21, 2021**  
 C. C. RESO.#1780

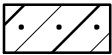

**NOTE:**

-  Indicates Zoning District Boundary
-  The area enclosed by the dotted line is rezoned by changing an existing R5 District to an M1-4/R7A District, and by establishing a Special Mixed Used District (MX-23).
-  Indicates a C1-3 District
-  Indicates a C2-3 District
-  Indicates a Special Mixed Use District (MX-23)

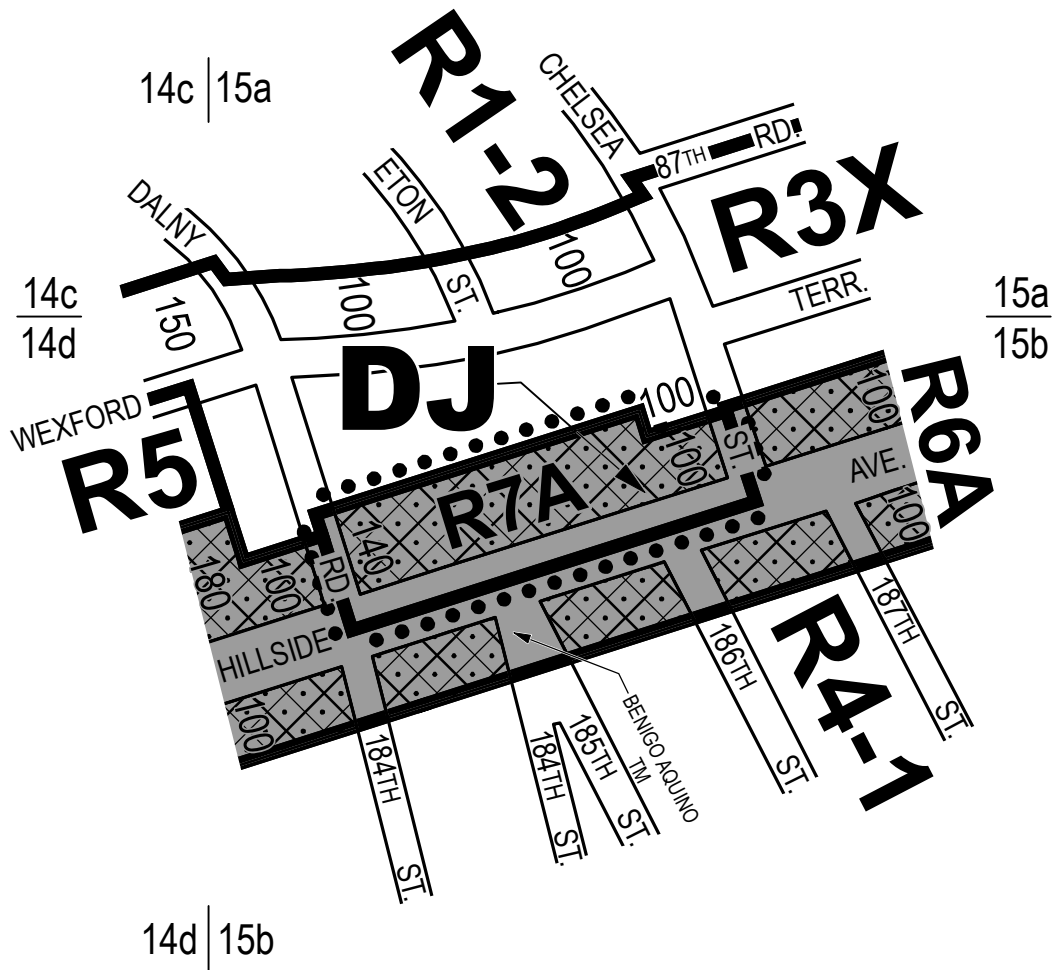

CITY PLANNING COMMISSION  
 CITY OF NEW YORK  
 DIAGRAM SHOWING  
**ZONING CHANGE**  
 ON SECTIONAL MAP  
**15b**  
 BOROUGH OF  
**QUEENS**

EFFECTIVE DATE
<b>November 23, 2021</b>
C. C. RESO.#1826

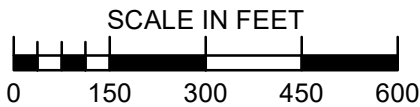

**NOTE:**

- Indicates Zoning District Boundary
- The area enclosed by the dotted line is rezoned by changing from existing R3X and R6A Districts to an R7A District, by establishing a C2-4 District within a proposed R7A District, and by establishing a Special Downtown Jamaica District (DJ).

Indicates a C2-4 District

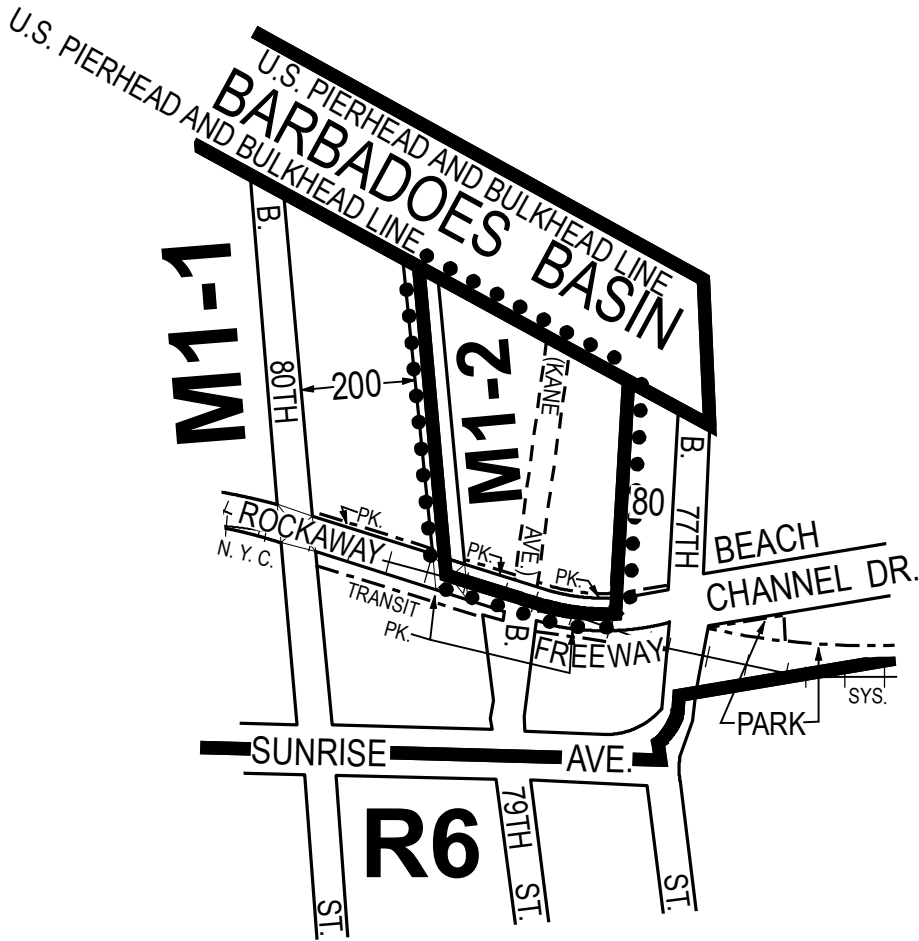

CITY PLANNING COMMISSION  
 CITY OF NEW YORK  
 DIAGRAM SHOWING  
**ZONING CHANGE**  
 ON SECTIONAL MAP  
**30c**  
 BOROUGH OF  
**QUEENS**

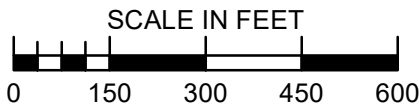

EFFECTIVE DATE
<b>December 09, 2021</b>
C. C. RESO.#1849

**NOTE:**

- Indicates Zoning District Boundary
- The area enclosed by the dotted line is rezoned by changing from an M1-1 District to an M1-2 District.

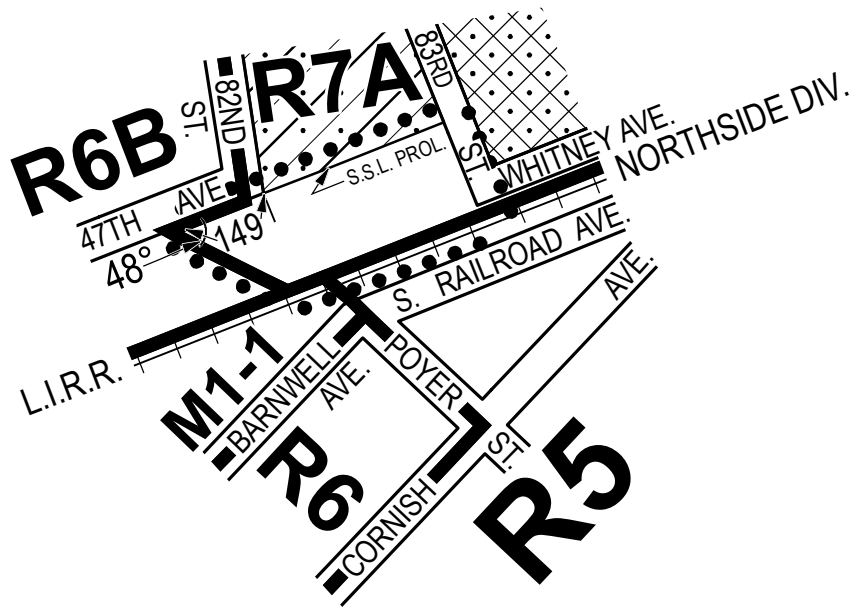



CITY PLANNING COMMISSION  
 CITY OF NEW YORK  
 DIAGRAM SHOWING  
**ZONING CHANGE**  
 ON SECTIONAL MAP  
**9d**  
 BOROUGH OF  
**QUEENS**

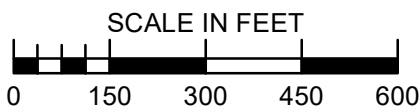

EFFECTIVE DATE  
**December 09, 2021**  
 C. C. RESO.#1858



**NOTE:**

-  Indicates Zoning District Boundary
-  The area enclosed by the dotted line is rezoned by changing from an M1-1 District to an R7A District.

 Indicates a C2-2 District

 Indicates a C2-3 District

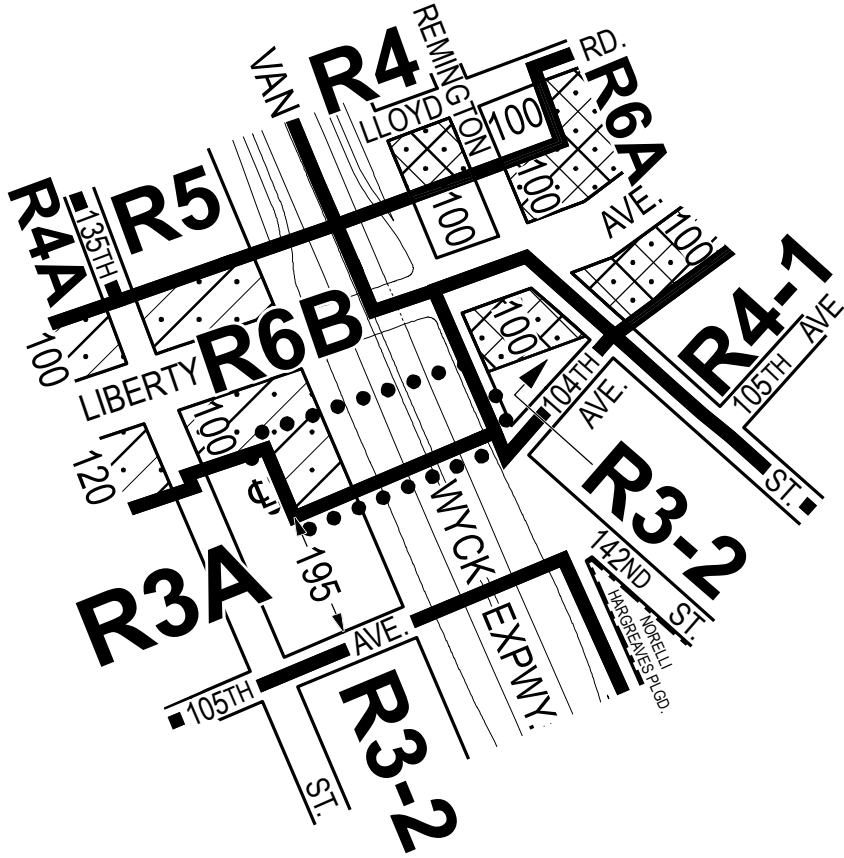





CITY PLANNING COMMISSION  
 CITY OF NEW YORK  
 DIAGRAM SHOWING  
**ZONING CHANGE**  
 ON SECTIONAL MAP  
**18c**  
 BOROUGH OF  
**QUEENS**

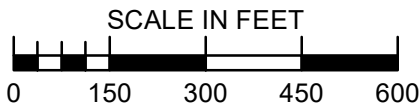

EFFECTIVE DATE  
**December 15, 2021**  
 C. C. RESO.#1892



**NOTE:**

-  Indicates Zoning District Boundary
-  The area enclosed by the dotted line is rezoned by changing an existing R3A District to an R6B District and by establishing a C2-3 District within the proposed R6B District.
-  Indicates a C2-3 District
-  Indicates a C2-4 District

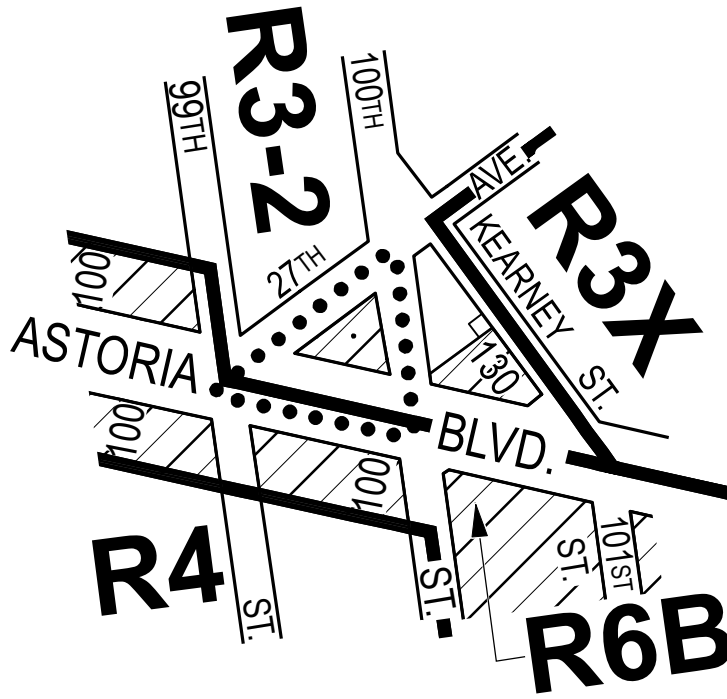

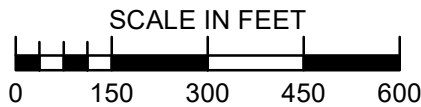

CITY PLANNING COMMISSION  
 CITY OF NEW YORK  
 DIAGRAM SHOWING  
**ZONING CHANGE**  
 ON SECTIONAL MAP  
**9c**  
 BOROUGH OF  
**QUEENS**

EFFECTIVE DATE
<b>February 24, 2022</b>
C. C. RESO.# <b>44</b>



**NOTE:**

-  Indicates Zoning District Boundary
-  The area enclosed by the dotted line is rezoned by establishing a C2-3 District within an existing R3-2 District.

 Indicates a C1-3 District

 Indicates a C2-3 District



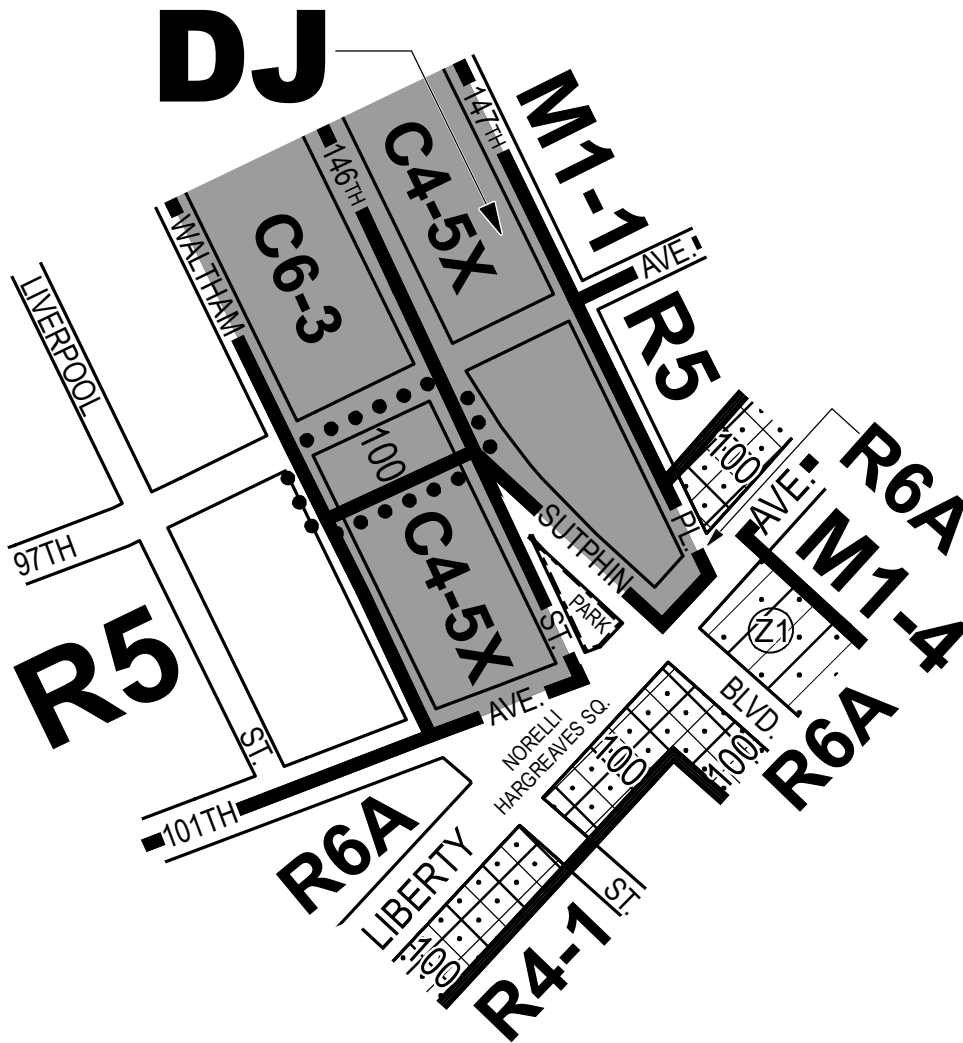



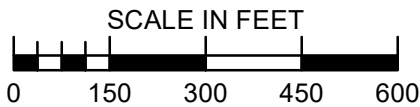

CITY PLANNING COMMISSION  
 CITY OF NEW YORK  
 DIAGRAM SHOWING  
**ZONING CHANGE**  
 ON SECTIONAL MAP  
**14d**  
 BOROUGH OF  
**QUEENS**

EFFECTIVE DATE  
**April 7, 2022**  
 C. C. RESO.#

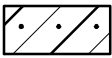
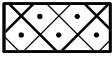

**NOTE:**

-  Indicates Zoning District Boundary
-  The area enclosed by the dotted line is rezoned by changing from an existing C4-5X District to an C6-3 District.
-  Indicates a C2-3 District
-  Indicates a C2-4 District
-  Indicates a Special Downtown Jamaica District

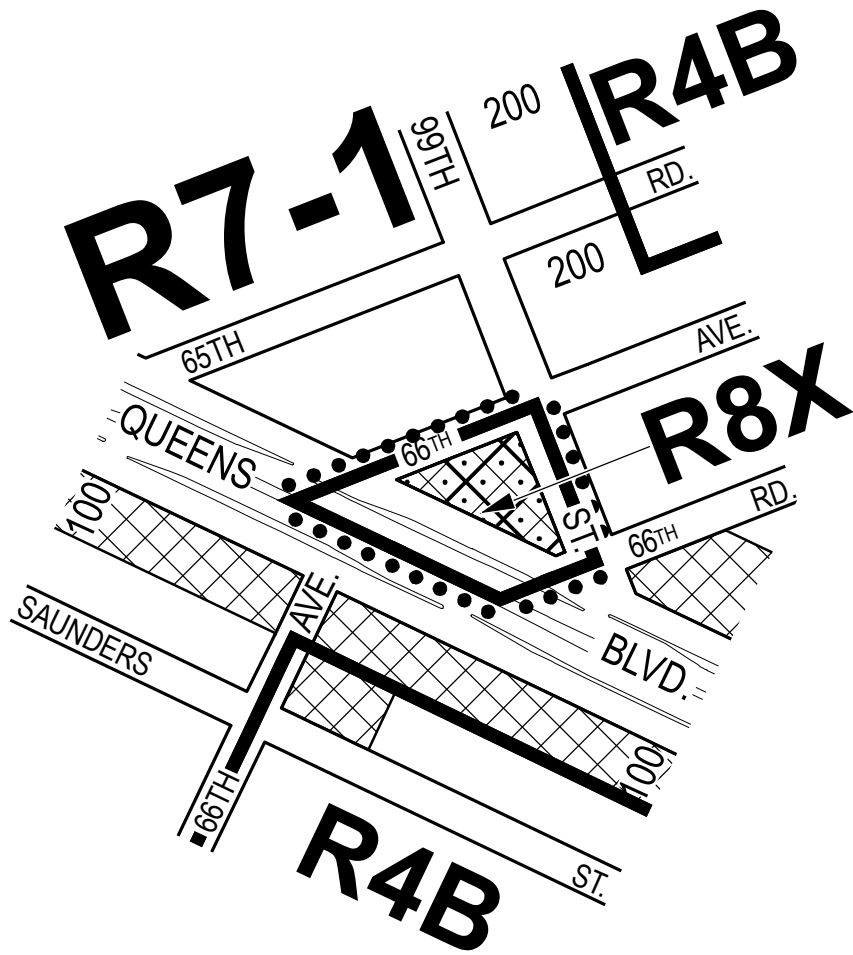



CITY PLANNING COMMISSION  
 CITY OF NEW YORK  
 DIAGRAM SHOWING  
**ZONING CHANGE**  
 ON SECTIONAL MAP

**14a**  
 BOROUGH OF  
**QUEENS**

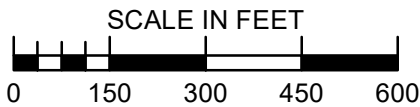
EFFECTIVE DATE  
**April 14, 2022**  
 C. C. RESO.#



**NOTE:**

-  Indicates Zoning District Boundary
-  The area enclosed by the dotted line is rezoned by eliminating a C1-2 District from within an existing R7-1 District, by changing an existing R7-1 District to an R8X District, and by establishing a C2-4 District within the proposed R8X District.

 Indicates a C1-2 District

 Indicates a C2-4 District

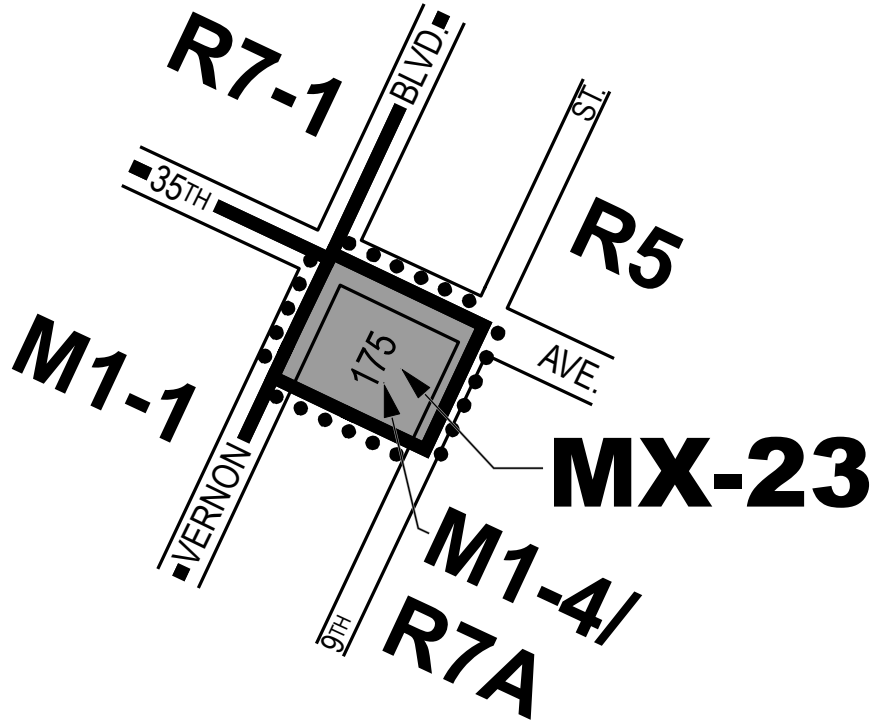

CITY PLANNING COMMISSION  
 CITY OF NEW YORK  
 DIAGRAM SHOWING  
**ZONING CHANGE**  
 ON SECTIONAL MAP



**9a**  
 BOROUGH OF  
**QUEENS**

EFFECTIVE DATE <b>May 19, 2022</b> C. C. RESO.# 181
---

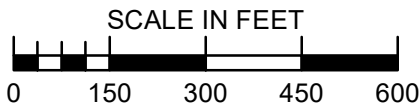

**NOTE:**

- Indicates Zoning District Boundary
- The area enclosed by the dotted line is rezoned by changing from an existing R5 to an M1-4/R7A District and by establishing a Special Mixed Use District **MX-23**.

Special Mixed Use District (**MX-23**)

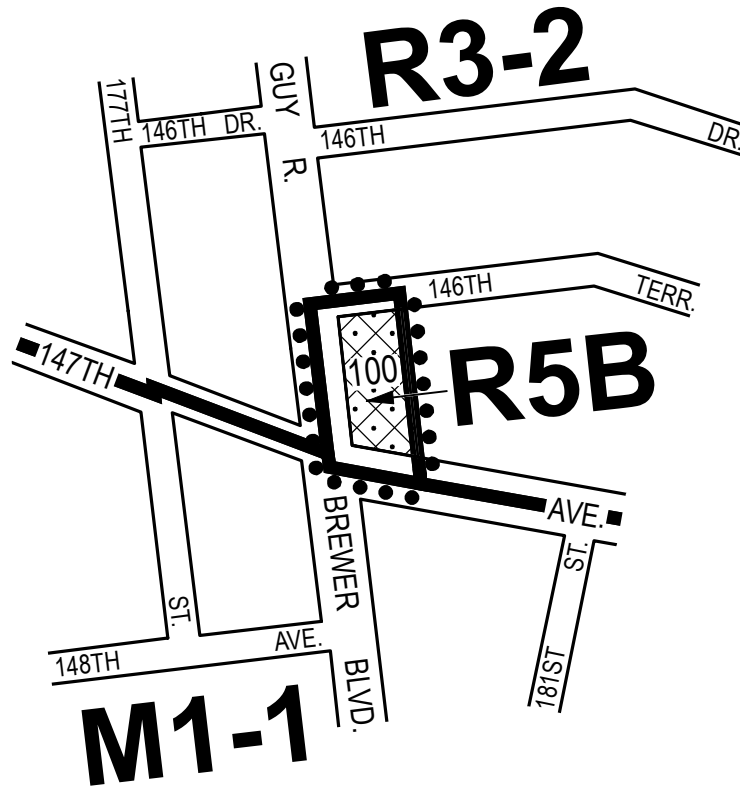

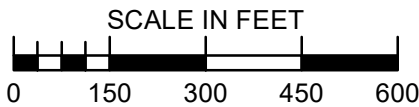

CITY PLANNING COMMISSION  
 CITY OF NEW YORK  
 DIAGRAM SHOWING  
**ZONING CHANGE**  
 ON SECTIONAL MAP  
**19b**  
 BOROUGH OF  
**QUEENS**

EFFECTIVE DATE  
**June 02, 2022**  
 C. C. RESO.# **218**



**NOTE:**

-  Indicates Zoning District Boundary
-  The area enclosed by the dotted line is rezoned by changing an existing R3-2 District to an R5B District and by establishing a C2-2 District within the proposed R5B District.
-  Indicates a C2-2 District

CITY PLANNING COMMISSION  
 CITY OF NEW YORK  
 DIAGRAM SHOWING  
**ZONING CHANGE**  
 ON SECTIONAL MAP  
**30c & 31a**  
 BOROUGH OF  
**QUEENS**

EFFECTIVE DATE  
**July 14, 2022**  
 C. C. RESO.# 272

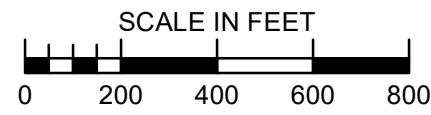

**NOTE:**

- Indicates Zoning District Boundary
- The area enclosed by the dotted line is rezoned by eliminating C1-2, C2-2 Districts from within existing R4 and R5 Districts, by changing R4, R4-1, R5, C3 and C8-1 Districts to R3A, R4-1, R6A and C3A Districts, by establishing C2-4 Districts within existing R4 and proposed R6A Districts, and by establishing a Special Coastal Risk District (CR).

- Indicates a C1-2 District
- Indicates a C2-2 District
- Indicates a C2-4 District
- MX-21** Special Mixed Use District (MX-21)
- CR** Indicates a Special Coastal Risk District

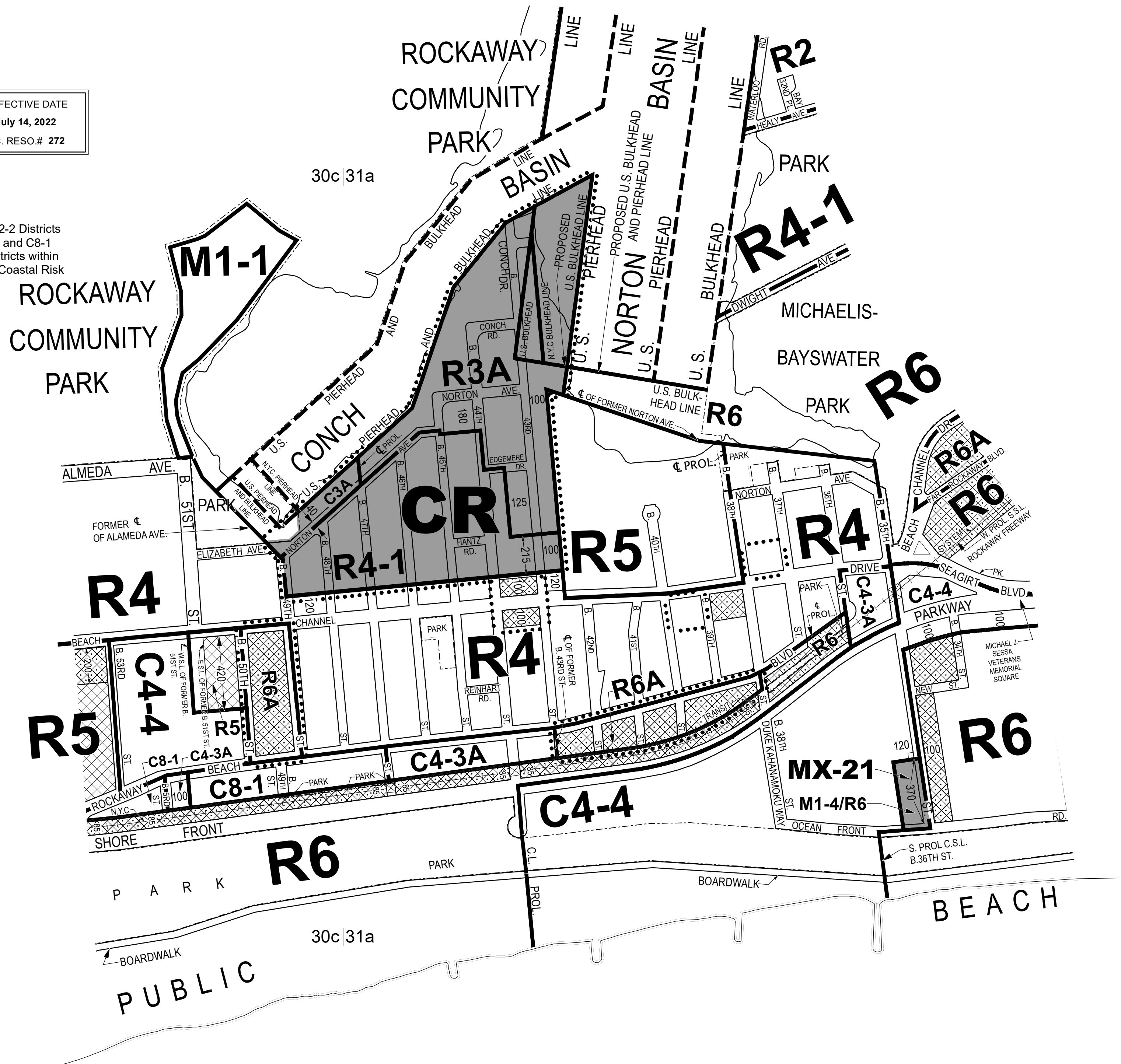

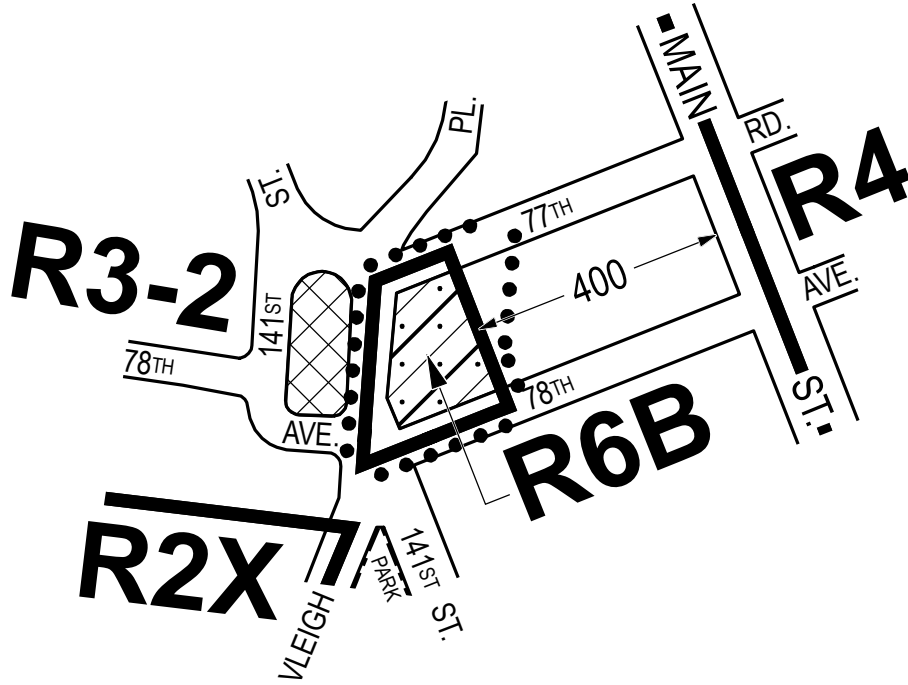



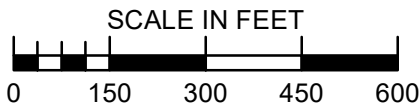

CITY PLANNING COMMISSION  
 CITY OF NEW YORK  
 DIAGRAM SHOWING  
**ZONING CHANGE**  
 ON SECTIONAL MAP  
**14c**  
 BOROUGH OF  
**QUEENS**

EFFECTIVE DATE  
**July 14, 2022**  
 C. C. RESO.# 277



**NOTE:**

-  Indicates Zoning District Boundary
-  The area enclosed by the dotted line is rezoned by eliminating a C1-2 District from within an existing R3-2 District, by changing an R3-2 District to an R6B District, and by establishing a C2-3 District within the proposed R6B District.
-  Indicates a C1-2 District
-  Indicates a C2-3 District

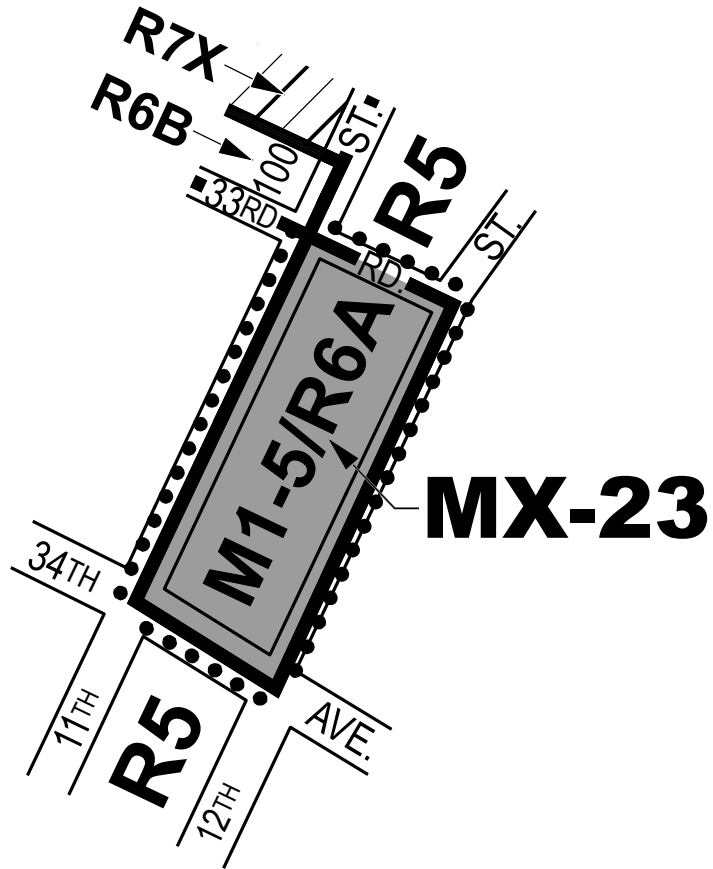

CITY PLANNING COMMISSION  
 CITY OF NEW YORK  
 DIAGRAM SHOWING  
**ZONING CHANGE**  
 ON SECTIONAL MAP

9a





BOROUGH OF  
**BROOKLYN**

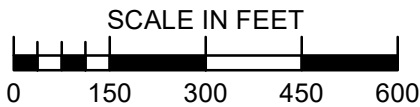

EFFECTIVE DATE
<b>July 14, 2022</b>
C. C. RESO.# 279

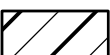

**NOTE:**

-  Indicates Zoning District Boundary
-  The area enclosed by the dotted line is rezoned by changing an R5 District to an M1-5/R6A District and by establishing a Special Mixed Use District (MX-23).
-  Indicates a C1-3 District
-  Indicates a Special Mixed Use District (**MX-23**)

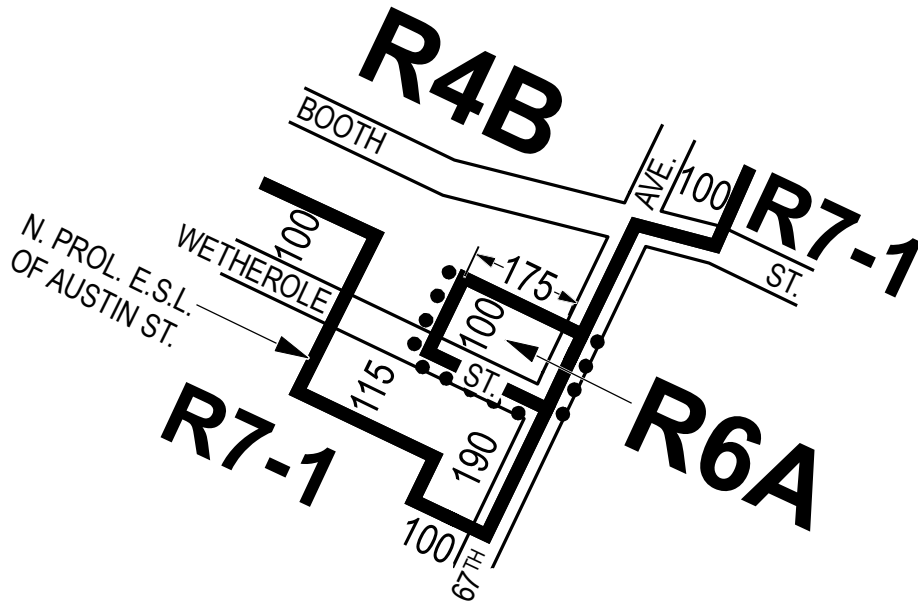

CITY PLANNING COMMISSION  
 CITY OF NEW YORK  
 DIAGRAM SHOWING  
**ZONING CHANGE**  
 ON SECTIONAL MAP  
**14a**  
 BOROUGH OF  
**QUEENS**

EFFECTIVE DATE
<b>July 14, 2022</b>
C. C. RESO.# 281

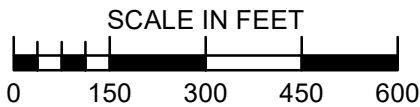

- NOTE:**
- Indicates Zoning District Boundary
  - The area enclosed by the dotted line is rezoned by changing from an R4B District to an R6A District.



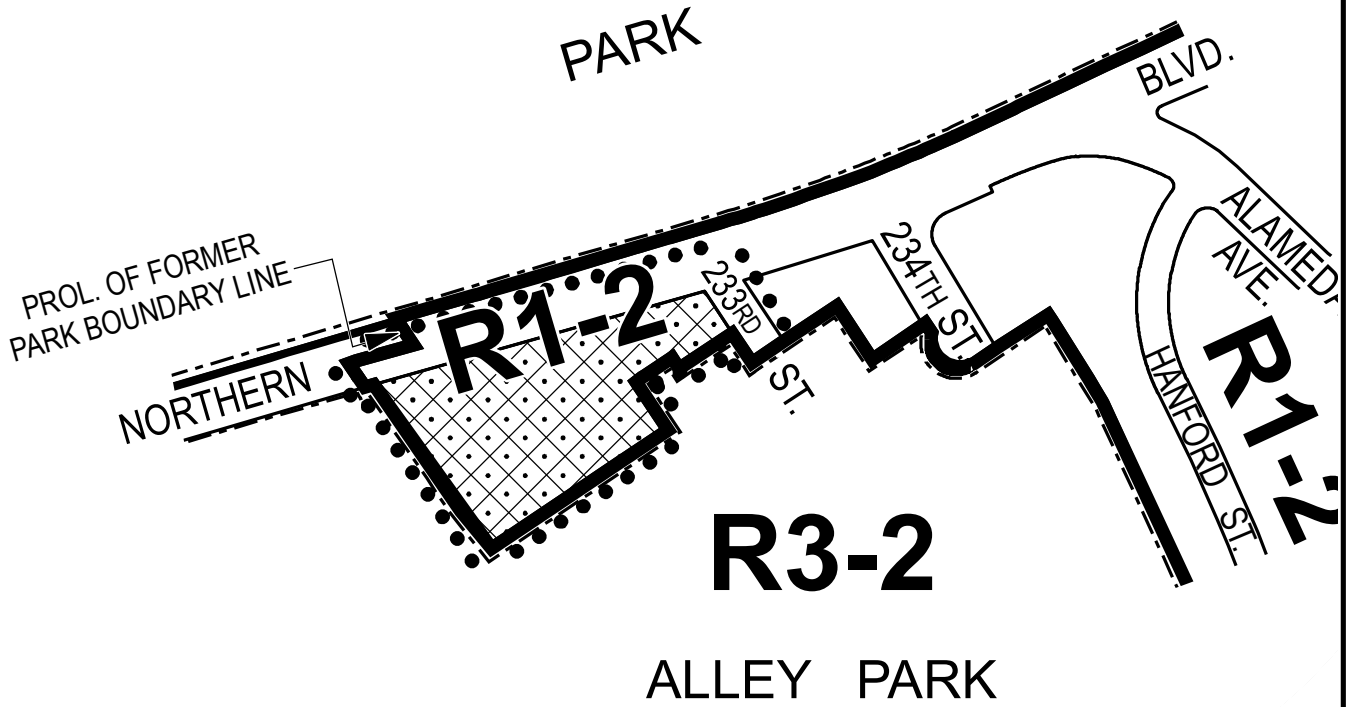

CITY PLANNING COMMISSION  
 CITY OF NEW YORK  
 DIAGRAM SHOWING  
**ZONING CHANGE**  
 ON SECTIONAL MAP  
**11a**  
 BOROUGH OF  
**QUEENS**



EFFECTIVE DATE
<b>September 29, 2022</b>
C. C. RESO.# 335

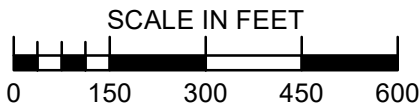

**NOTE:**

- Indicates Zoning District Boundary
- The area enclosed by the dotted line is rezoned by establishing a C2-2 District within an existing R1-2 District.
- Indicates a C2-2 District

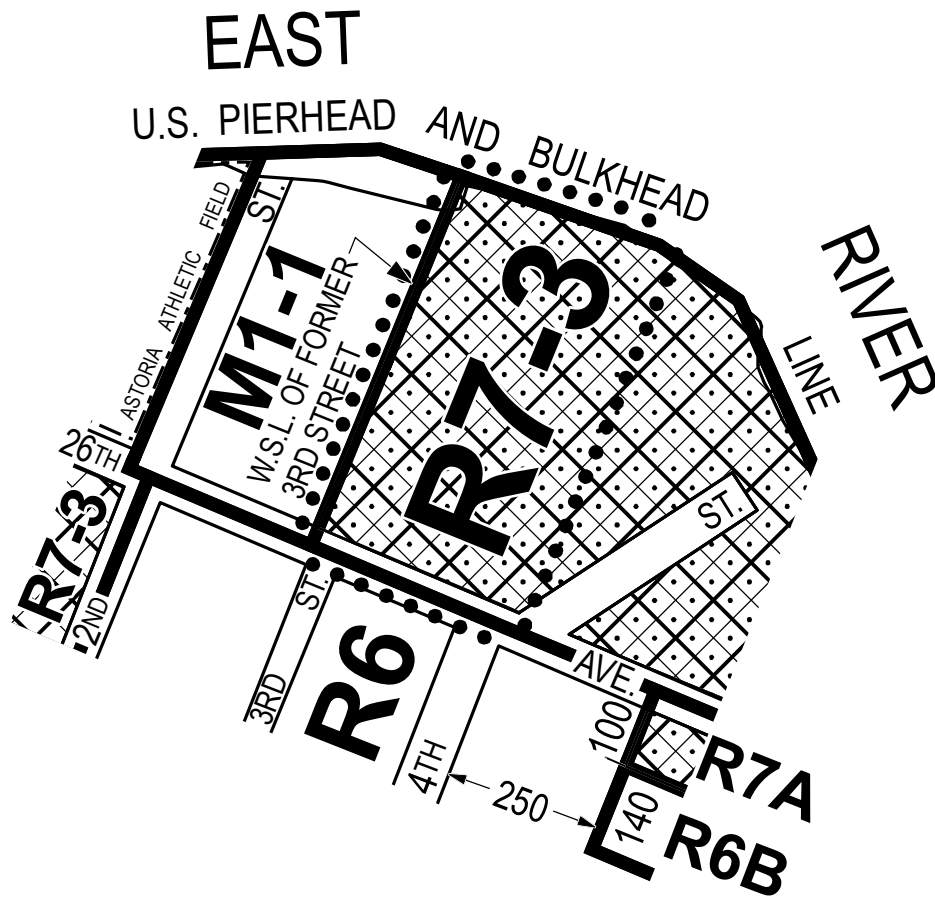



CITY PLANNING COMMISSION  
 CITY OF NEW YORK  
 DIAGRAM SHOWING  
**ZONING CHANGE**  
 ON SECTIONAL MAP

**9a**  
 BOROUGH OF  
**QUEENS**

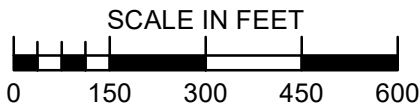
EFFECTIVE DATE  
**September 29, 2022**  
 C. C. RESO.# 336



**NOTE:**

-  Indicates Zoning District Boundary
-  The area enclosed by the dotted line is rezoned by changing an existing M1-1 District to an R7-3 District and by establishing a C2-4 within the proposed R7-3 District.



Indicates a C1-4 District



Indicates a C2-4 District

THIS DIAGRAM REFLECTS PROPOSED CHANGES IN THE CITY MAP  
 PURSUANT TO RELATED MAPPING APPLICATION C 220206 MMQ

NOTE: THIS DIAGRAM IS FOR ILLUSTRATIVE PURPOSES ONLY.

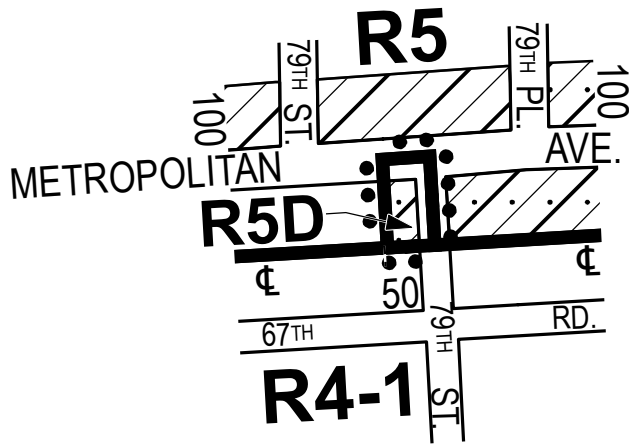



CITY PLANNING COMMISSION  
 CITY OF NEW YORK  
 DIAGRAM SHOWING  
**ZONING CHANGE**  
 ON SECTIONAL MAP  
**13d**  
 BOROUGH OF  
**QUEENS**

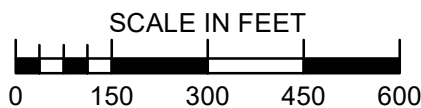

EFFECTIVE DATE
<b>October 12, 2022</b>
C. C. RESO.# 355



**NOTE:**

-  Indicates Zoning District Boundary
-  The area enclosed by the dotted line is rezoned by changing an existing R5 District to an R5D District and by establishing a C2-3 District within the proposed R5D District.

 Indicates a C1-3 District

 Indicates a C2-3 District

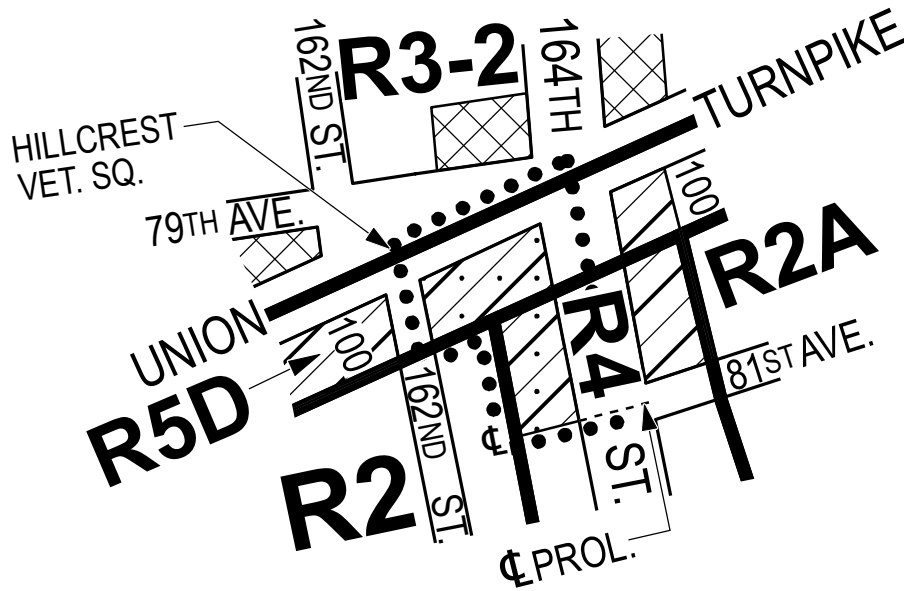





CITY PLANNING COMMISSION  
 CITY OF NEW YORK  
 DIAGRAM SHOWING  
**ZONING CHANGE**  
 ON SECTIONAL MAP  
**14c**  
 BOROUGH OF  
**QUEENS**

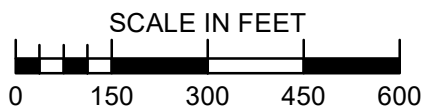

EFFECTIVE DATE
<b>October 12, 2022</b>
C. C. RESO.# <b>356</b>

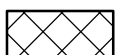

**NOTE:**

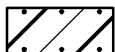
-  Indicates Zoning District Boundary
-  The area enclosed by the dotted line is rezoned by eliminating a C1-3 District from within existing R4 and R5D Districts, and by establishing a C2-3 District within the existing R4 and R5D Districts.
-  Indicates a C1-2 District
-  Indicates a C1-3 District
-  Indicates a C2-3 District

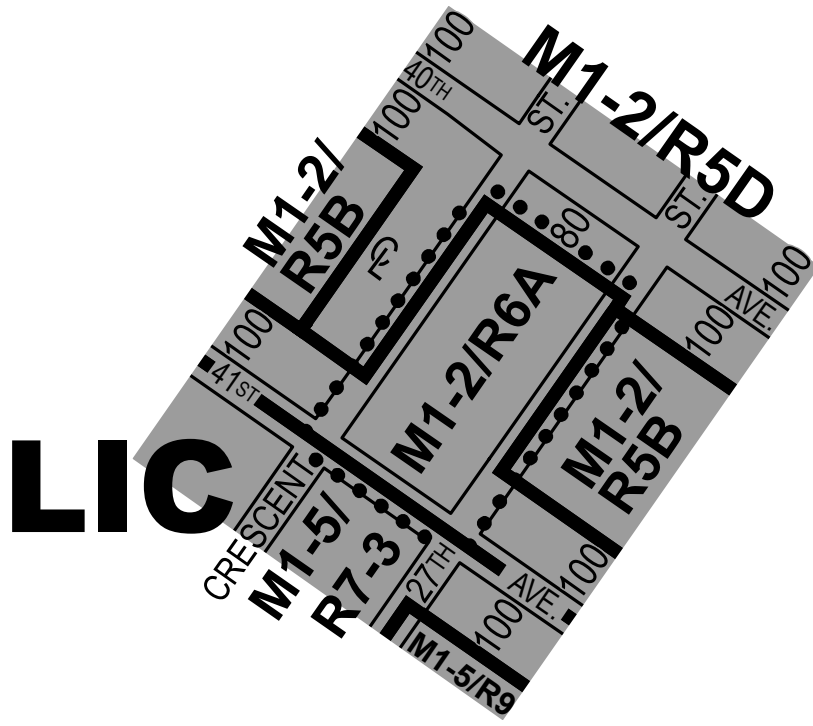

CITY PLANNING COMMISSION  
 CITY OF NEW YORK  
 DIAGRAM SHOWING  
**ZONING CHANGE**  
 ON SECTIONAL MAP

**9b**  
 BOROUGH OF  
**QUEENS**

EFFECTIVE DATE <b>October 12, 2022</b> C. C. RESO.# 359
---

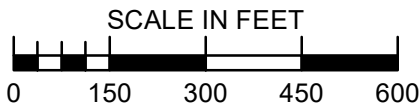

**NOTE:**

- Indicates Zoning District Boundary
- The area enclosed by the dotted line is rezoned by changing M1-2/R5B and M1-2/R5D Districts to an M1-2/R6A District.

Indicates a Special Long Island City Mixed Use District (**LIC**).

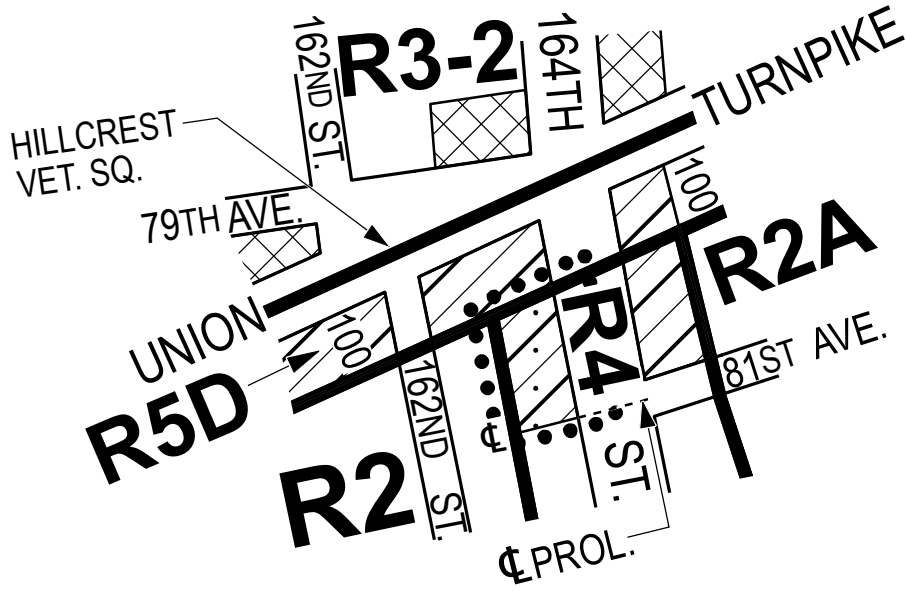

CITY PLANNING COMMISSION  
 CITY OF NEW YORK  
 DIAGRAM SHOWING  
**ZONING CHANGE**  
 ON SECTIONAL MAP  
**14c**  
 BOROUGH OF  
**QUEENS**



EFFECTIVE DATE  
**November 22, 2022**  
 C. C. RESO.# **356**

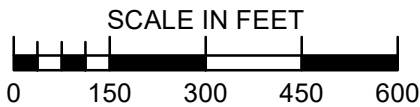

**NOTE:**

- Indicates Zoning District Boundary
- The area enclosed by the dotted line is rezoned by eliminating a C1-3 District from within an existing R4 District, and by establishing a C2-3 District within the existing R4 District.
- Indicates a C1-2 District
- Indicates a C1-3 District
- Indicates a C2-3 District

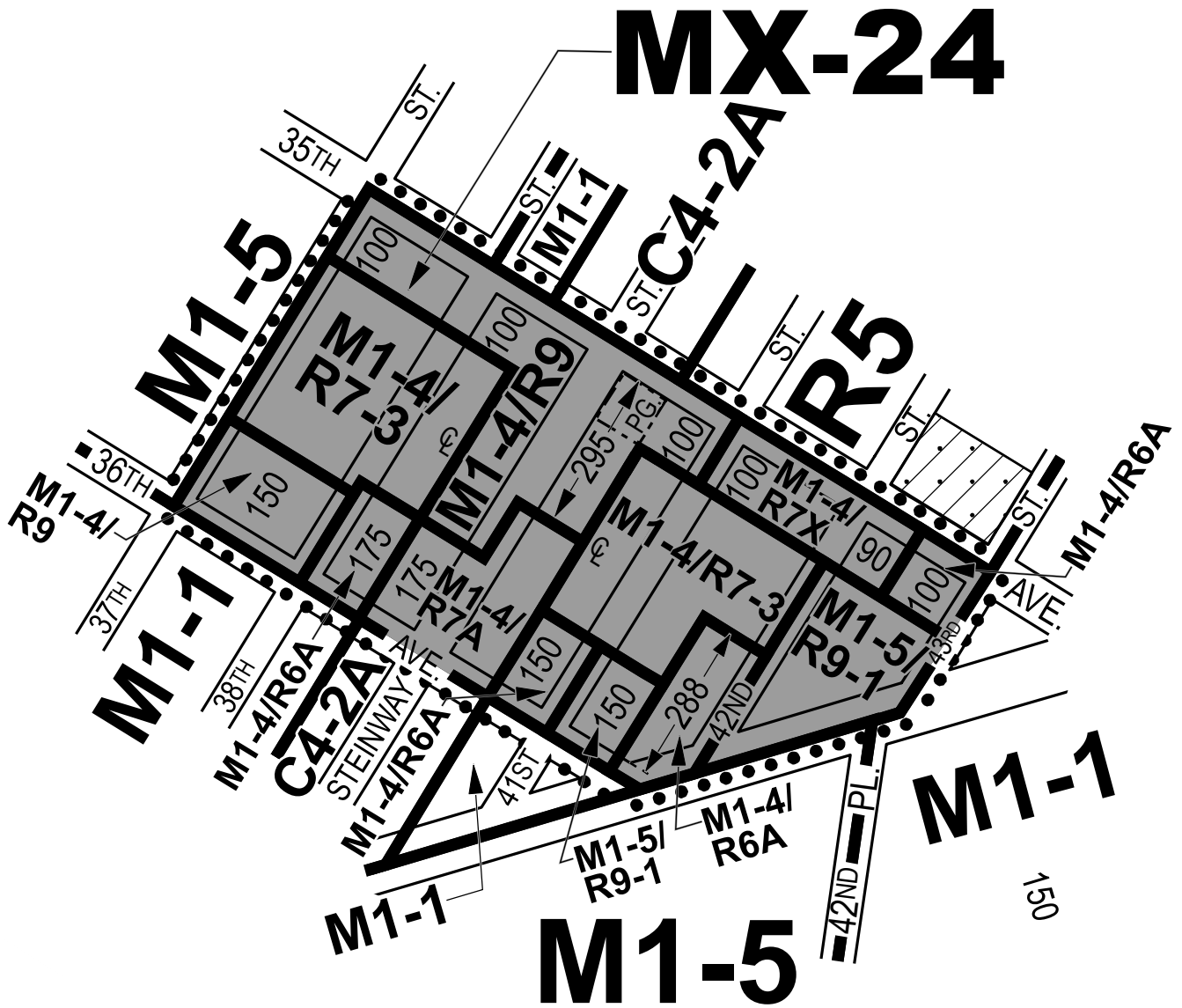

CITY PLANNING COMMISSION  
 CITY OF NEW YORK  
 DIAGRAM SHOWING  
**ZONING CHANGE**  
 ON SECTIONAL MAP

9b



BOROUGH OF  
QUEENS

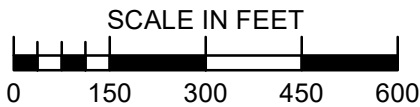

EFFECTIVE DATE
November 22, 2022
C. C. RESO.# 406

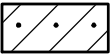
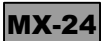

NOTE:

-  Indicates Zoning District Boundary
-  The area enclosed by the dotted line is rezoned by changing C4-2A and M1-1 Districts to M1-4/R6A, M1-4/R7A, M1-4/R7-3, M1-4/R7X, M1-4/R9, M1-5/R9-1, and by establishing a Special Mixed Use District (MX-24).
-  Indicates a C2-1 District
-  Indicates a Mixed Use District (MX-24)

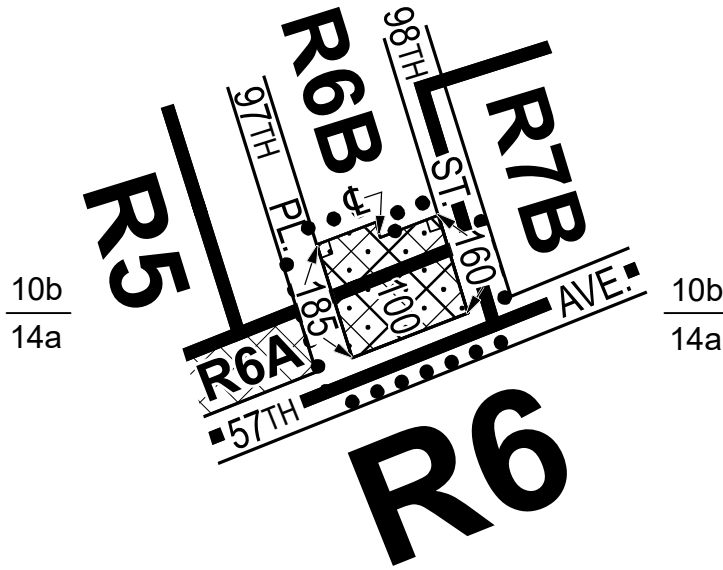

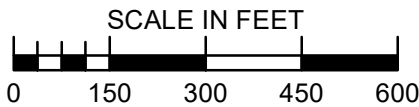

CITY PLANNING COMMISSION  
 CITY OF NEW YORK  
 DIAGRAM SHOWING  
**ZONING CHANGE**  
 ON SECTIONAL MAP  
**10b & 14a**  
 BOROUGH OF  
**BROOKLYN**

EFFECTIVE DATE  
**January 19, 2023**  
 C. C. RESO.# 467



**NOTE:**

-  Indicates Zoning District Boundary
-  The area enclosed by the dotted line is rezoned by eliminating a C1-2 District from within an existing R6A District and by establishing C2-4 Districts within existing R6A and R6B Districts.

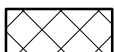
 Indicates a C1-2 District

 Indicates a C2-4 District



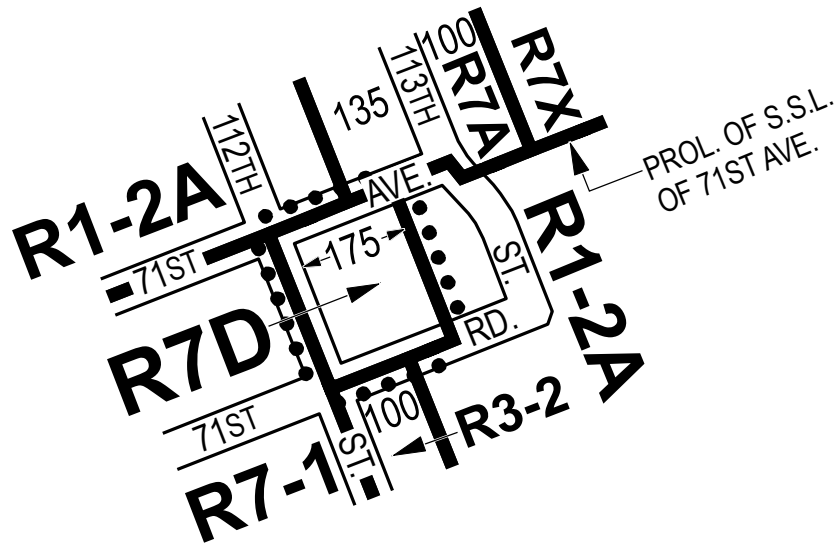

CITY PLANNING COMMISSION  
 CITY OF NEW YORK  
 DIAGRAM SHOWING  
**ZONING CHANGE**  
 ON SECTIONAL MAP  
**14a**  
 BOROUGH OF  
**QUEENS**



EFFECTIVE DATE
<b>February 02, 2023</b>
C. C. RESO.# <b>497</b>

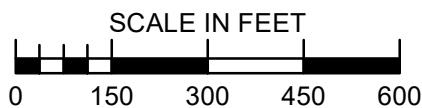

**NOTE:**

- Indicates Zoning District Boundary
- The area enclosed by the dotted line is rezoned by changing from an existing R1-2A District to an R7D District.

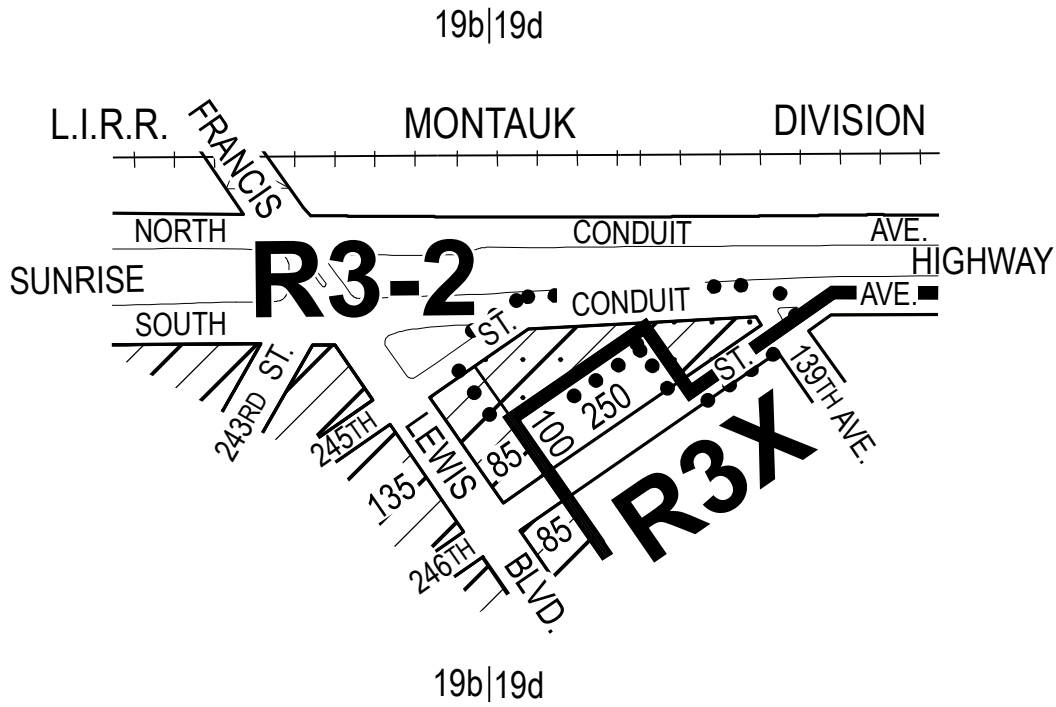





CITY PLANNING COMMISSION  
 CITY OF NEW YORK  
 DIAGRAM SHOWING  
**ZONING CHANGE**  
 ON SECTIONAL MAP  
**19b & 19d**  
 BOROUGH OF  
**QUEENS**

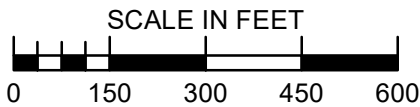

EFFECTIVE DATE
<b>April 27, 2023</b>
C. C. RESO.# <b>602</b>

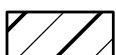

**NOTE:**

-  Indicates Zoning District Boundary
-  The area enclosed by the dotted line is rezoned by eliminating a C1-3 District from within an existing R3-2 District and by establishing a C2-3 District within the R3-2 District.
-  Indicates a C1-3 District
-  Indicates a C2-3 District

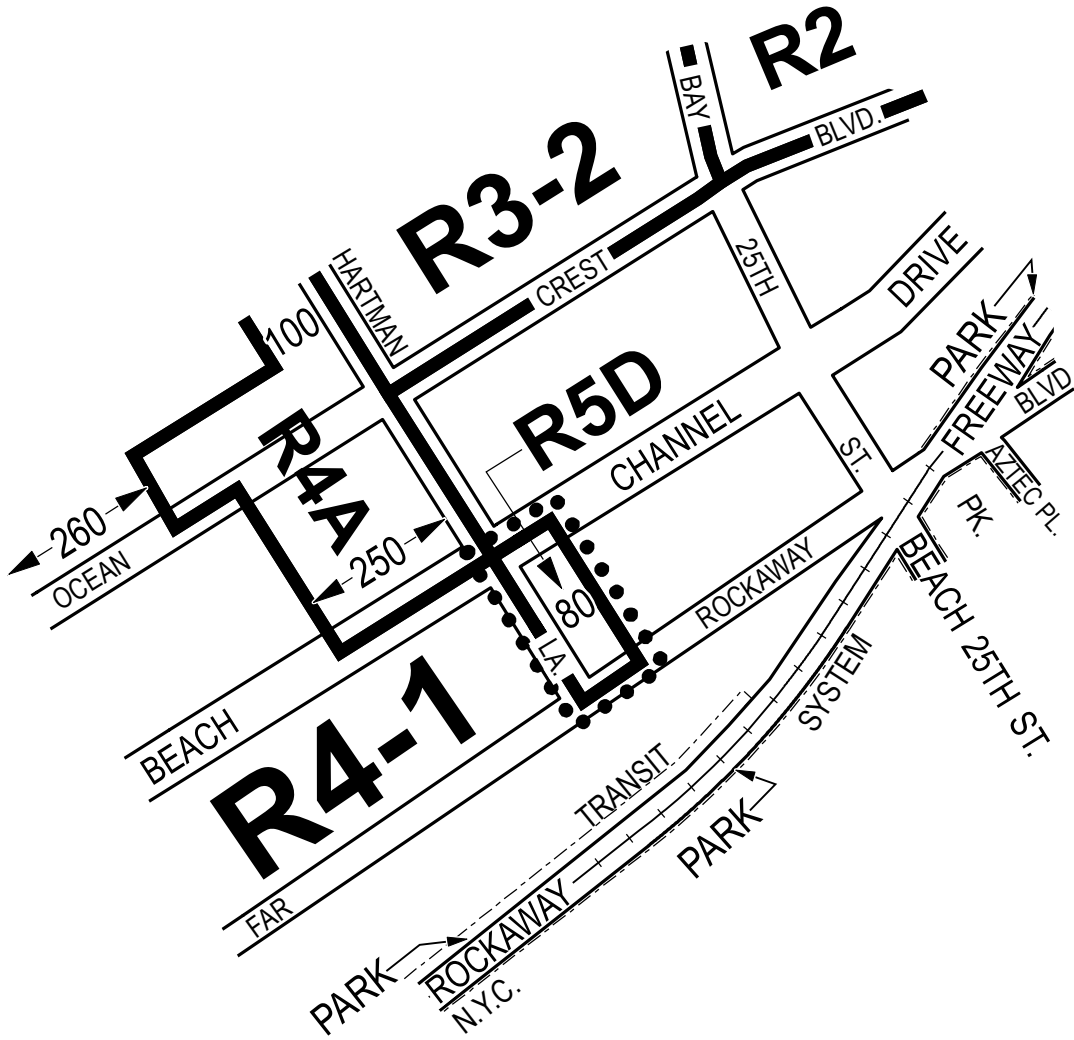

CITY PLANNING COMMISSION  
 CITY OF NEW YORK  
 DIAGRAM SHOWING  
**ZONING CHANGE**  
 ON SECTIONAL MAP  
**31a**  
 BOROUGH OF  
**QUEENS**



EFFECTIVE DATE
<b>April 27, 2023</b>
C. C. RESO. # 603

- NOTE:**
- Indicates Zoning District Boundary
  - The area enclosed by the dotted line is rezoned by changing an R4-1 District to an R5D District.

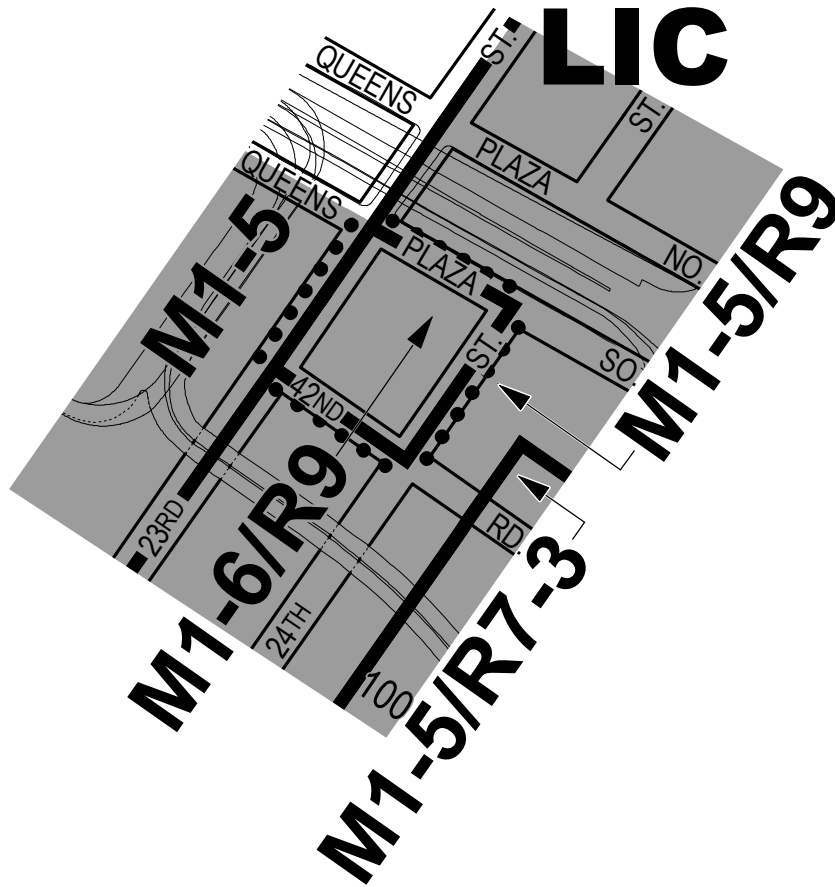

CITY PLANNING COMMISSION  
 CITY OF NEW YORK  
 DIAGRAM SHOWING  
**ZONING CHANGE**  
 ON SECTIONAL MAP  
**9b**  
 BOROUGH OF  
**QUEENS**

EFFECTIVE DATE
<b>May 11, 2023</b>
C. C. RESO.# <b>634</b>

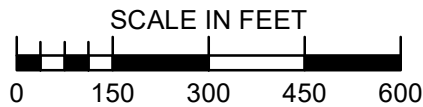

**NOTE:**

- Indicates Zoning District Boundary
- The area enclosed by the dotted line is rezoned by changing from an existing M1-5/R9 District to an M1-6/R9 District.
- Indicates a Special Long Island City Mixed Use District

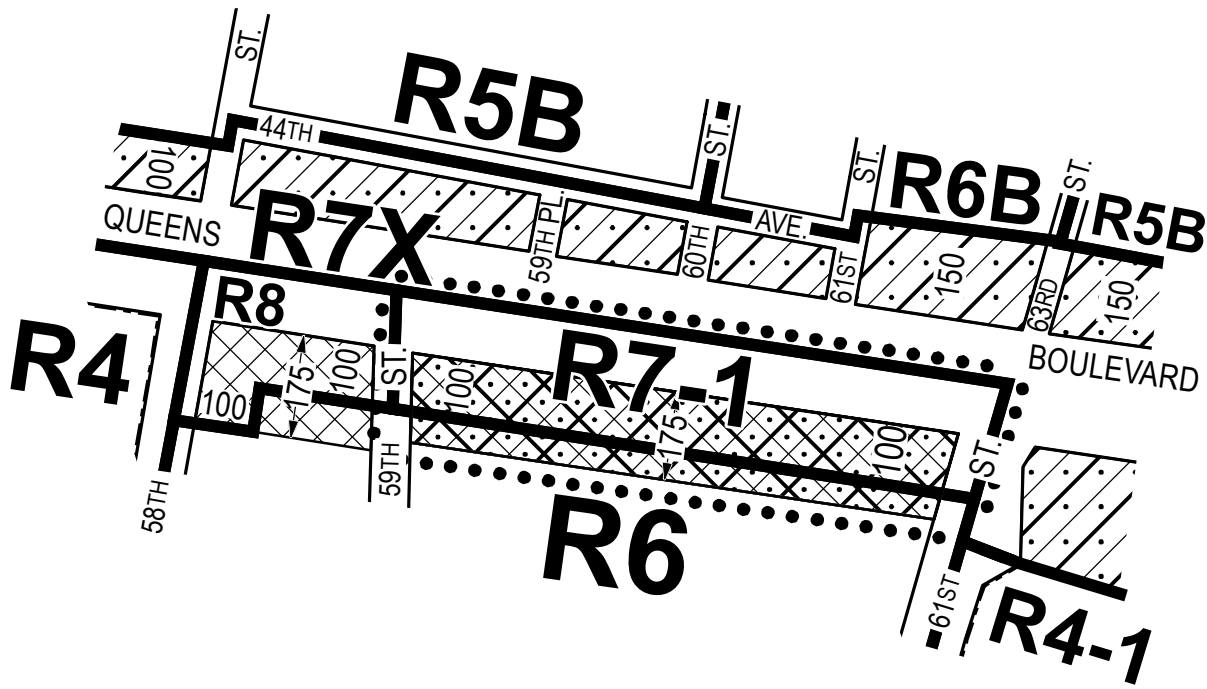





CITY PLANNING COMMISSION  
 CITY OF NEW YORK  
 DIAGRAM SHOWING  
**ZONING CHANGE**  
 ON SECTIONAL MAP  
**9d**  
 BOROUGH OF  
**QUEENS**

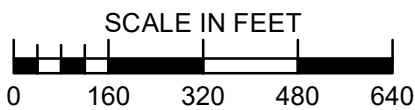

EFFECTIVE DATE  
**May 25, 2023**  
 C. C. RESO.# 650

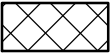
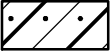

**NOTE:**

-  Indicates Zoning District Boundary
-  The area enclosed by the dotted line is rezoned by eliminating C1-2 Districts from within existing R6 and R7-1 Districts, and establishing a C2-4 District within the existing R6 and R7-1 Districts.
-  Indicates a C1-2 District
-  Indicates a C2-3 District
-  Indicates a C2-4 District

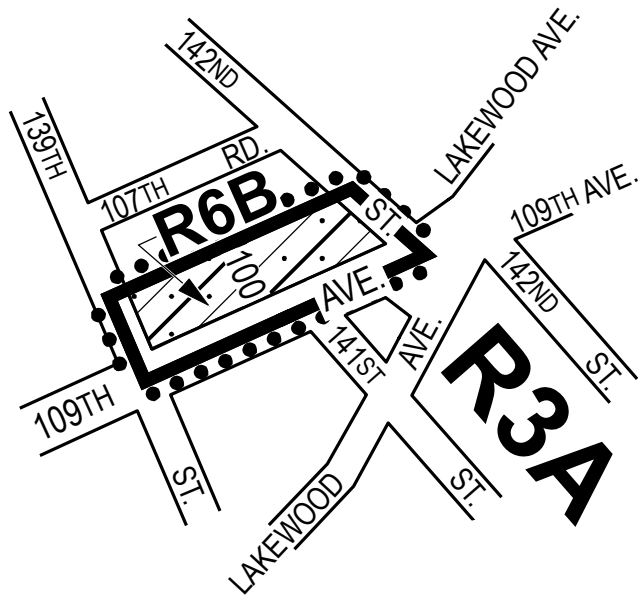

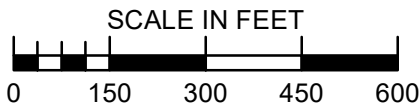

CITY PLANNING COMMISSION  
 CITY OF NEW YORK  
 DIAGRAM SHOWING  
**ZONING CHANGE**  
 ON SECTIONAL MAP  
**18c**  
 BOROUGH OF  
**QUEENS**

EFFECTIVE DATE  
**May 25, 2023**  
 C. C. RESO.# 659



**NOTE:**

-  Indicates Zoning District Boundary
-  The area enclosed by the dotted line is rezoned by changing an existing R3A District to a R6B District and by establishing a C2-3 District within the proposed R6B District.
-  Indicates a C2-3 District