



# Bureau of Fire Prevention

Entrance Door Fire  
Emergency Markings  
(Effective 3/30/2018)

**NYC**

Bill de Blasio  
Mayor

**FDNY**

Daniel A. Nigro  
Commissioner



# R-1 and R-2 Occupancies

- Directional signs serve to assist emergency response personnel in locating dwelling units.
- **Required for:**
  - unsprinklered buildings with more than 8 dwellings on a floor.
  - Multi floor dwelling units
  - Stairwell doors\*

\*Excludes buildings fully protected by sprinkler system



# Markings and Symbols

1

5

A

The numbers and letters identify the dwelling unit.



The star identifies the main entrance to the dwelling.



The triangle identifies each secondary entrance.

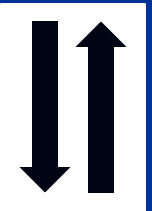

The arrows identify living spaces above or below entrance.



**“Sandwich design.”** The direction of the arrow shows location of living space, the horizontal line identifies no living space on that floor.



# Placement of Markings

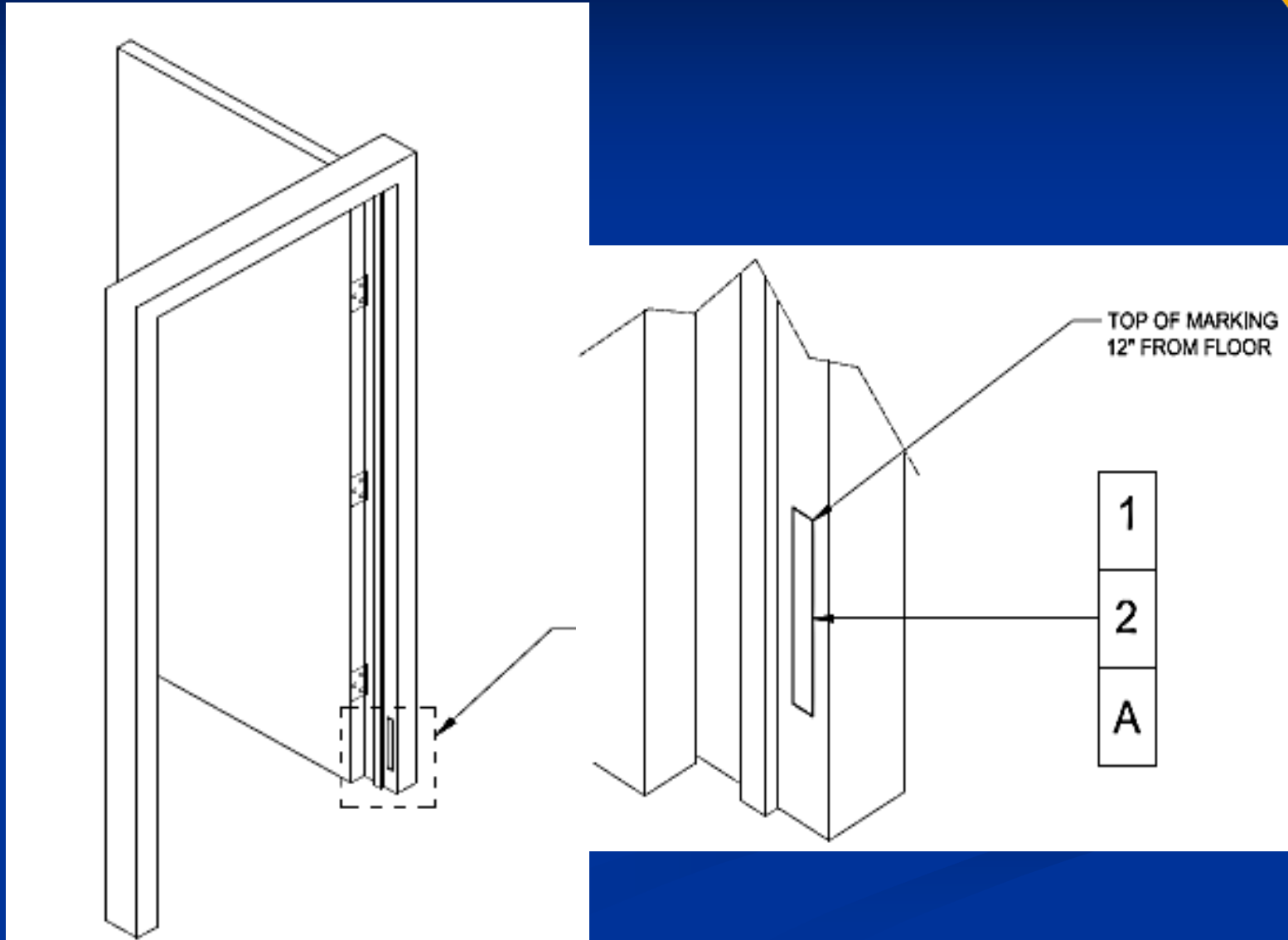

# For Example



Dwelling unit designated as  
10A and has a single entrance

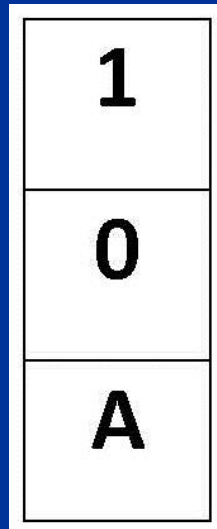

Top of marking 12”  
from the floor

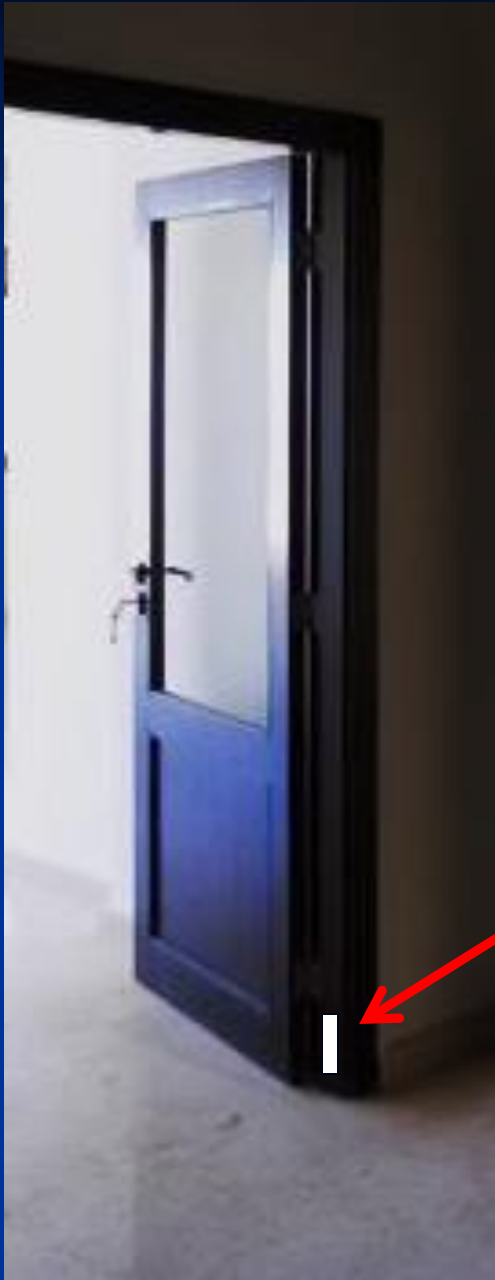



# Dwelling unit:

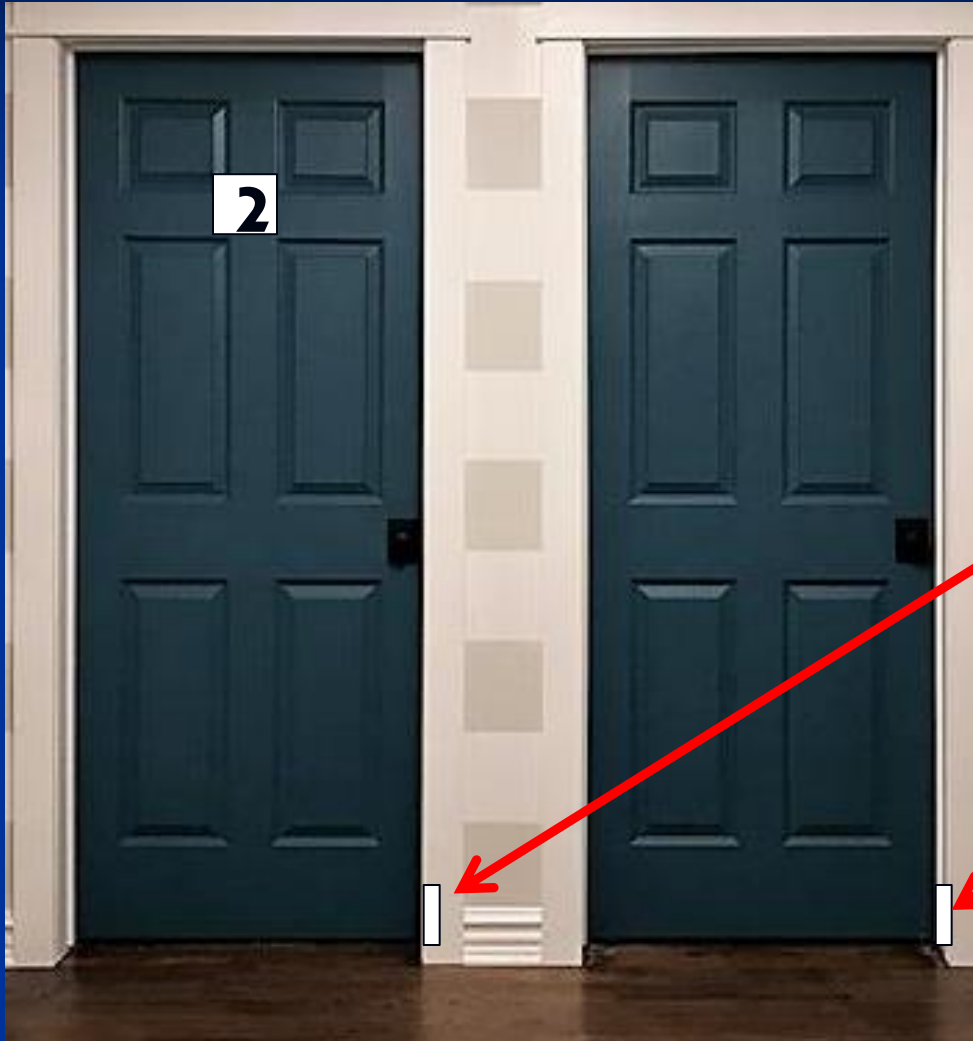

- Unit 2
- multi-entrance dwelling
- ★ main entrance
- ▲ secondary entrance





## Dwelling unit:

- 12A
- A single entrance
- A multi-floor dwelling
- Living space on entry floor and floor above

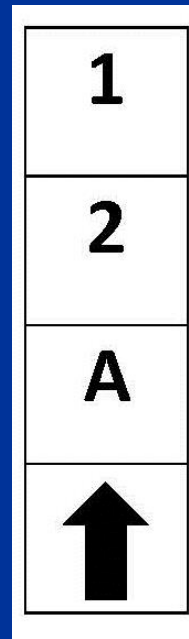



## Dwelling unit:

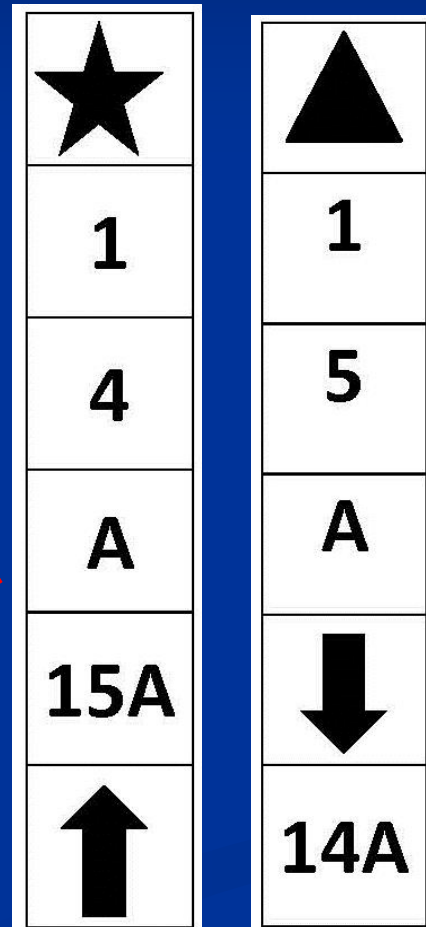

- Two floor dwelling unit
- 14A is main entrance
- 15A is secondary entrance
- Living space on entry floor (14A) and floor above (15A)





# “Sandwich Design”



Each has single entrance on same floor.

• **17A:** No living space on entry floor, living space is floor above.

1
7
A
↑

• **17B:** living space on entry floor

1
7
B

• **17C:** No living space on entry floor, living space is floor below

1
7
C
↓



Existing illuminated EXIT sign

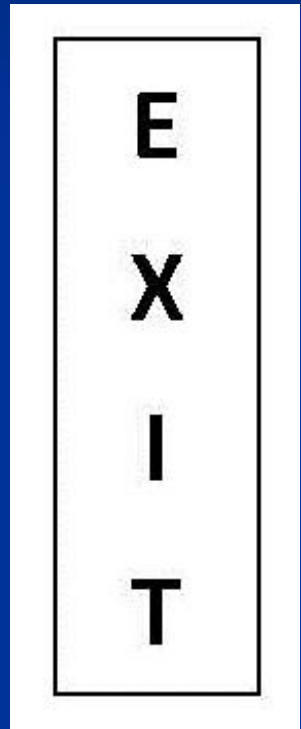

Stairwell letter designation

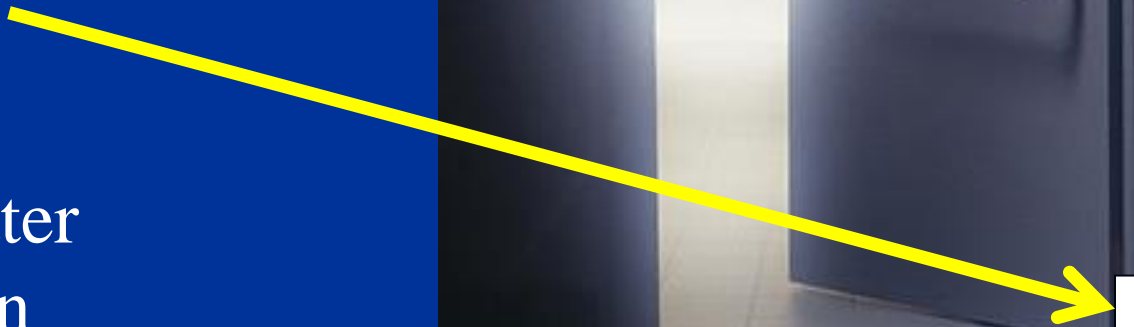



# More Information

- Fire Code: FC 505.3-505.4

<https://www1.nyc.gov/site/fdny/about/resources/code-and-rules/nyc-fire-code.page>

- FDNY Rules: 3 RCNY 505-01 and 505-02

<https://www1.nyc.gov/assets/fdny/downloads/pdf/about/fdny-rules.pdf>

- NYC Fire Code Guide: Chapter 5 (FAQ #40-50)

<http://www1.nyc.gov/assets/fdny/downloads/pdf/business/nyc-fire-code-guide.pdf>