

REGO PARK COMMUNITY LIBRARY QUEENS PUBLIC LIBRARY

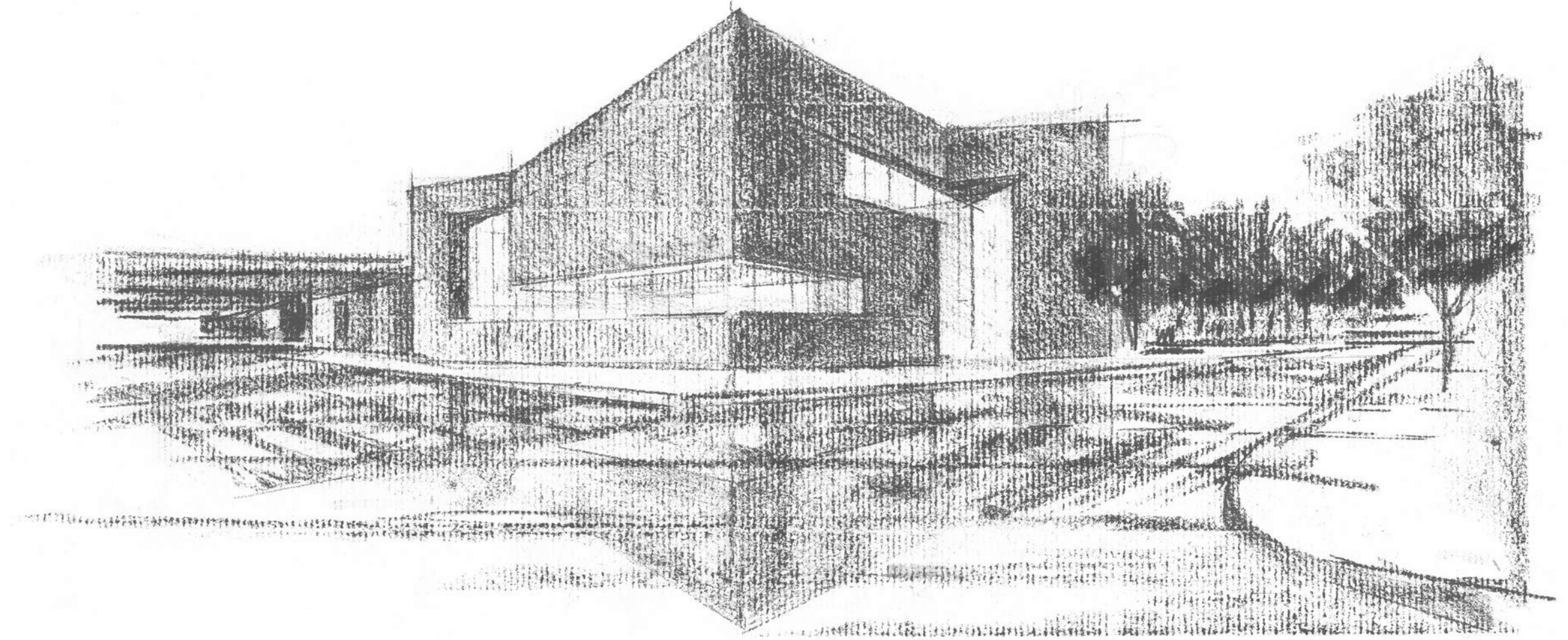

WEISS/MANFREDI
ARCHITECTURE / LANDSCAPE / URBANISM

QUEENS PUBLIC LIBRARY / DDC

COMMUNITY BOARD PRESENTATION
MARCH 28, 2023

CURRENT PROJECT STATUS

The Construction Document package is under revisions by the architect based on DDC review comments. Review of bid documents is ongoing.

Current Phase: Design 90% (Construction Documents)

Projected Design Completion: Summer 2023

Projected Construction Start: Spring 2024

Project Duration: 3 years

Construction Budget: \$32.9M



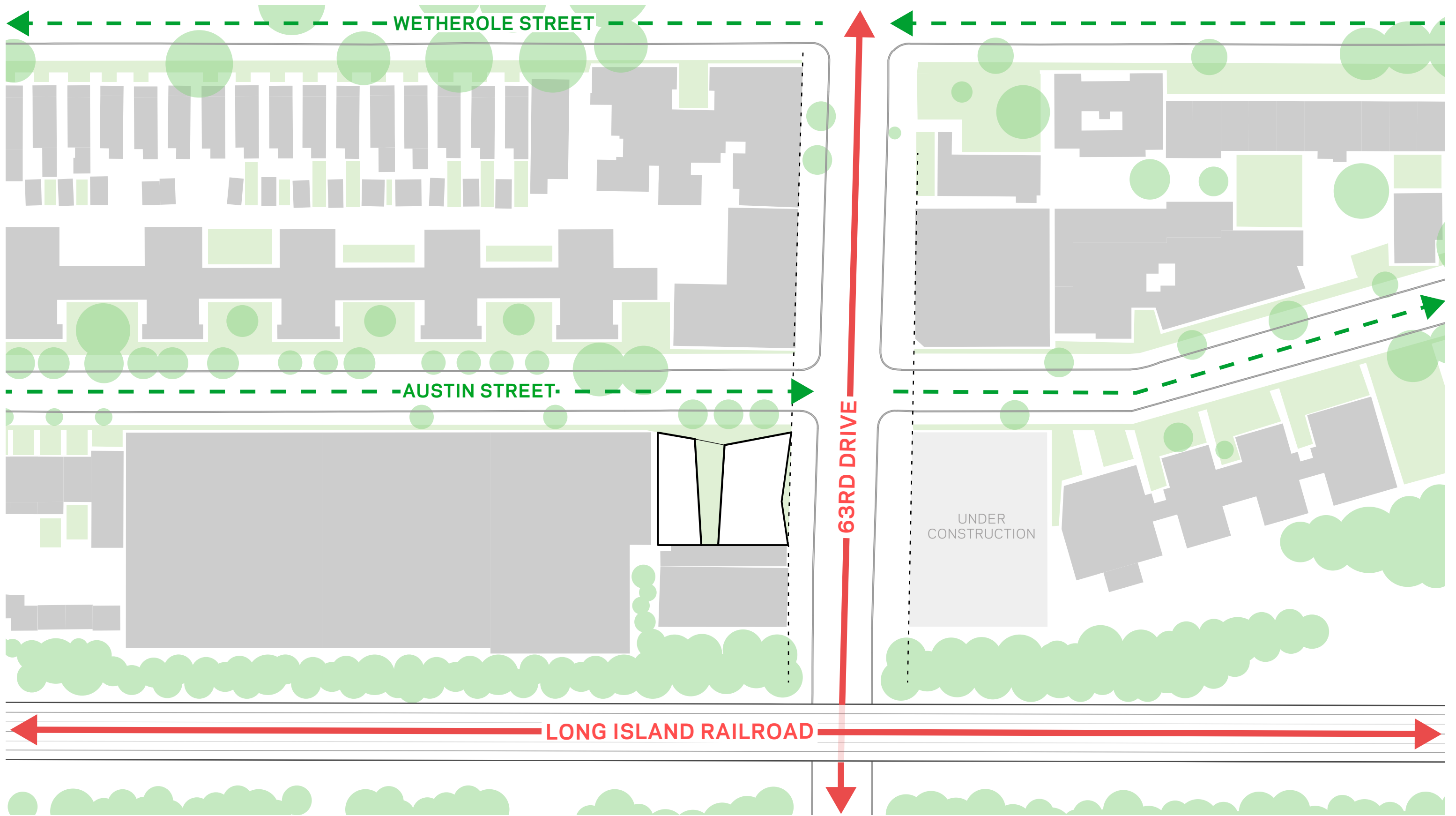



WEISS / MANFREDI
QUEENS PUBLIC LIBRARY / DDC

REGO PARK COMMUNITY LIBRARY
MARCH 28, 2023

PROPOSED RENDERINGS
VIEW OF MAIN ENTRY



WEISS / MANFREDI
QUEENS PUBLIC LIBRARY / DDC

REGO PARK COMMUNITY LIBRARY
MARCH 28, 2023

PROPOSED RENDERINGS
VIEW FROM 63RD DRIVE

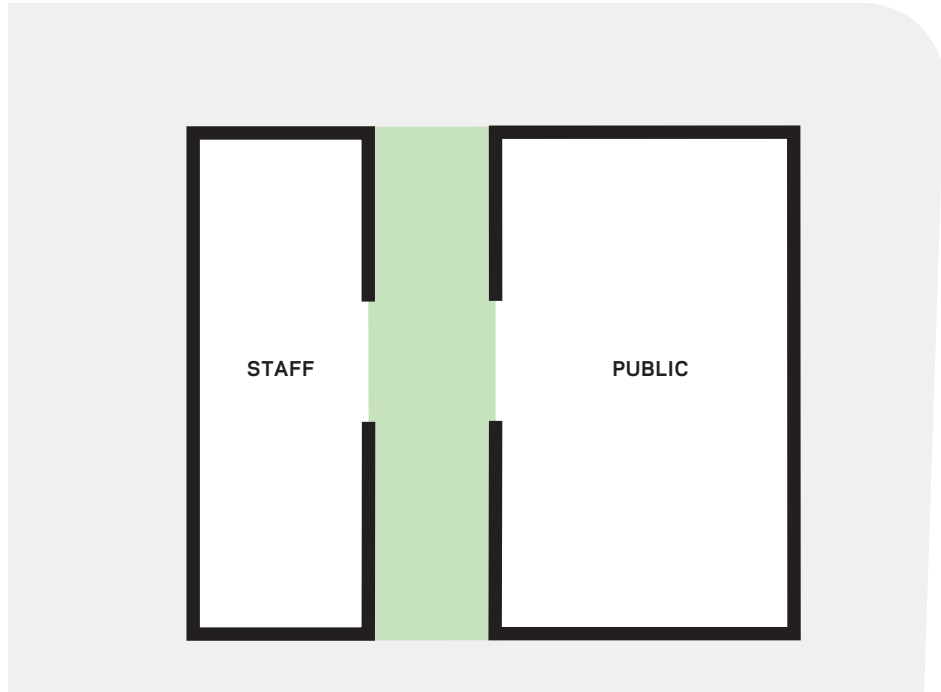

1. SEPARATE PROGRAM TYPES AND LINK WITH A GENEROUS CIRCULATION ZONE

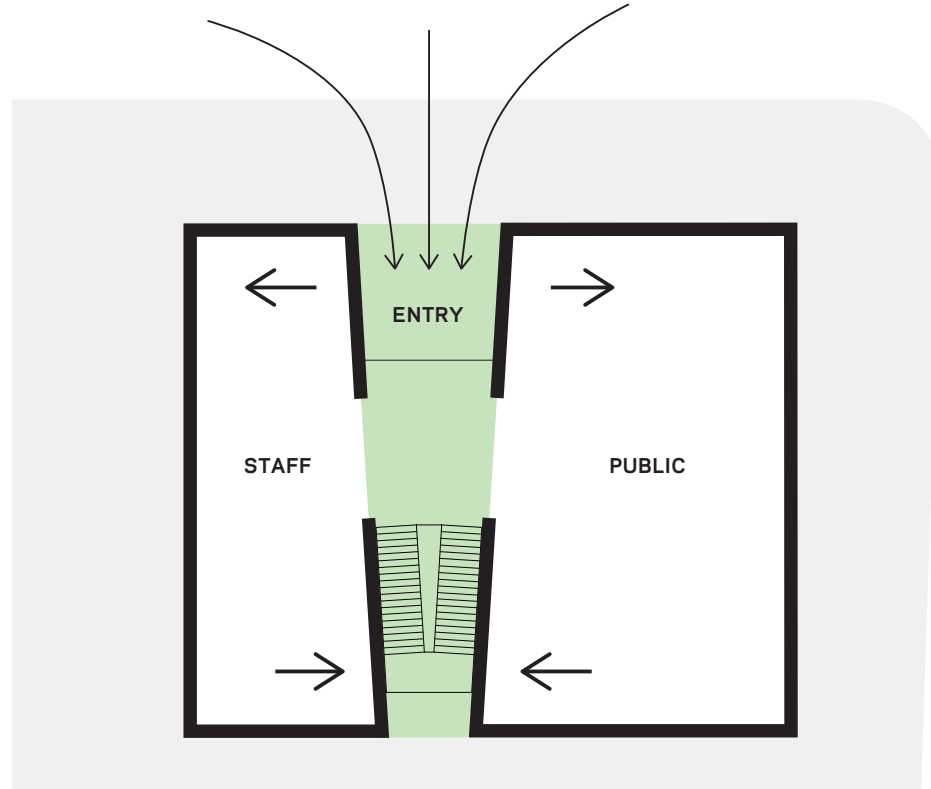

2. ADJUST ANGLES TO ALLOW FOR AN INVITING ENTRY AND A NESTLED STAIR

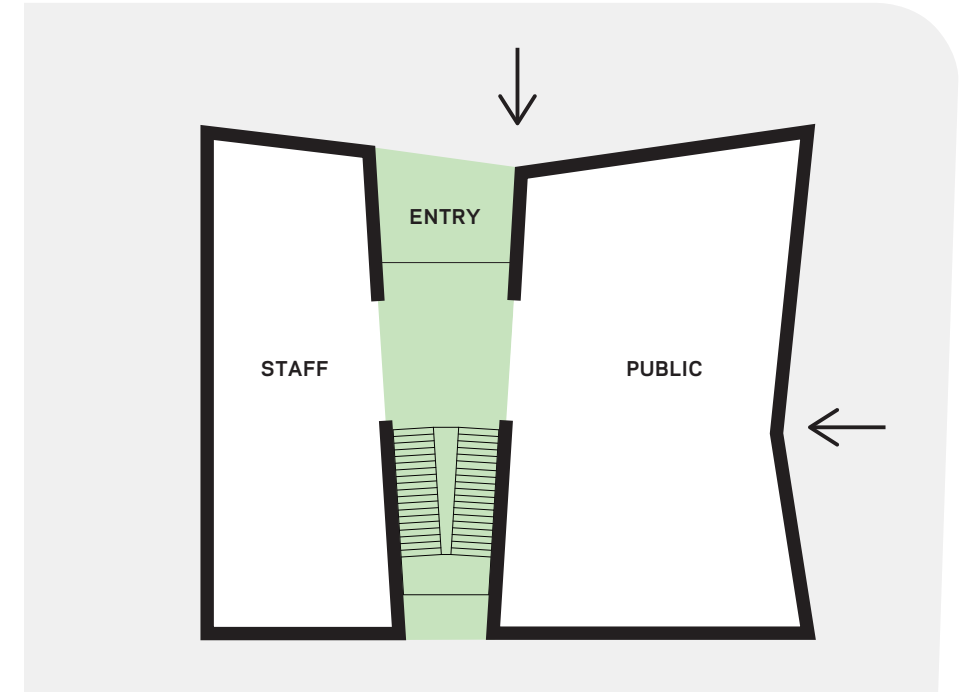

3. PUSH IN ENTRY FACADE FOR OBLIQUE VIEWS ALONG BUSY STREET

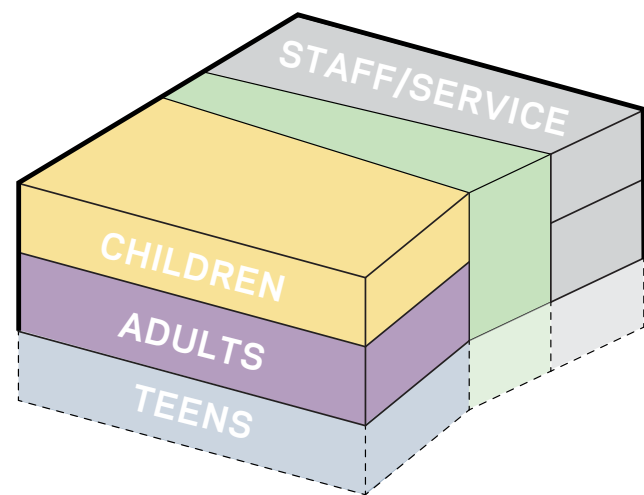

1. ORGANIZE PUBLIC PROGRAM BY FLOOR

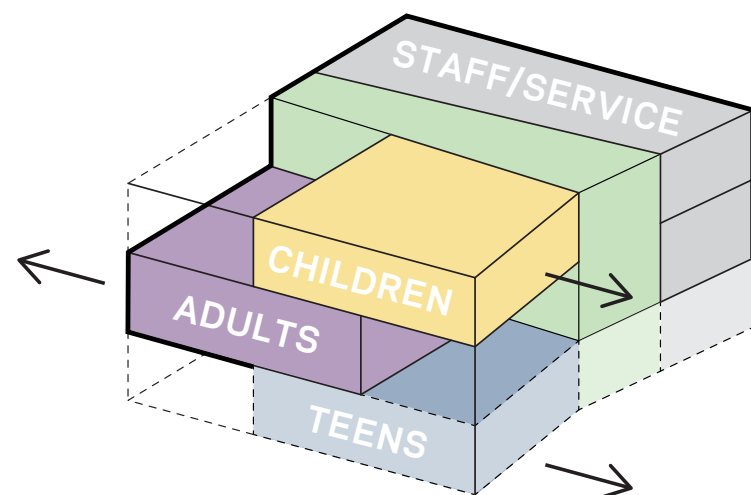

2. PULL APART PROGRAM FOR VISUAL CONNECTION AND DAYLIGHT

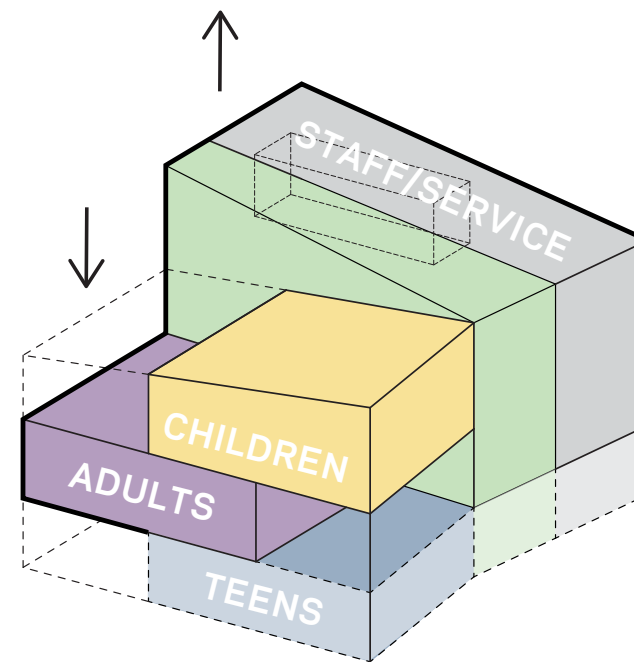

3. SHAPE ROOFLINE TO SCALE SPACES AND INCORPORATE MEP REQUIREMENTS

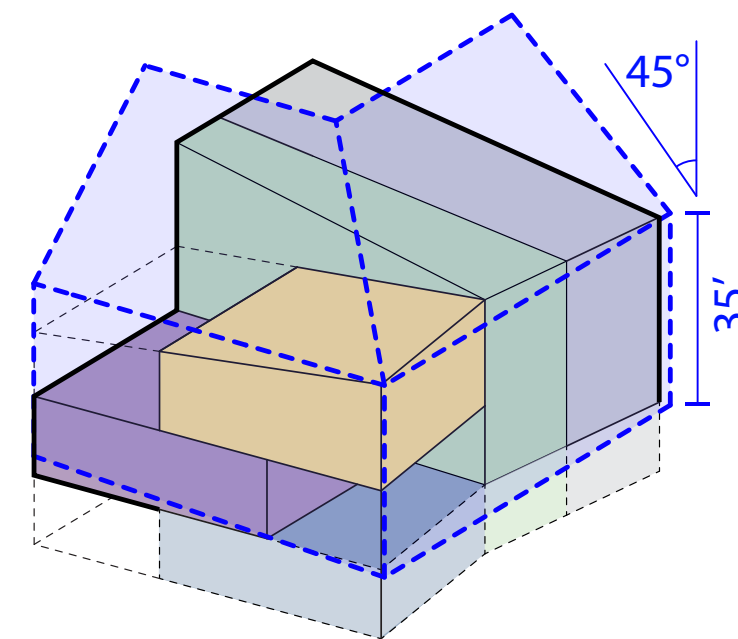

4. CONFORMANCE TO ZONING ENVELOPE

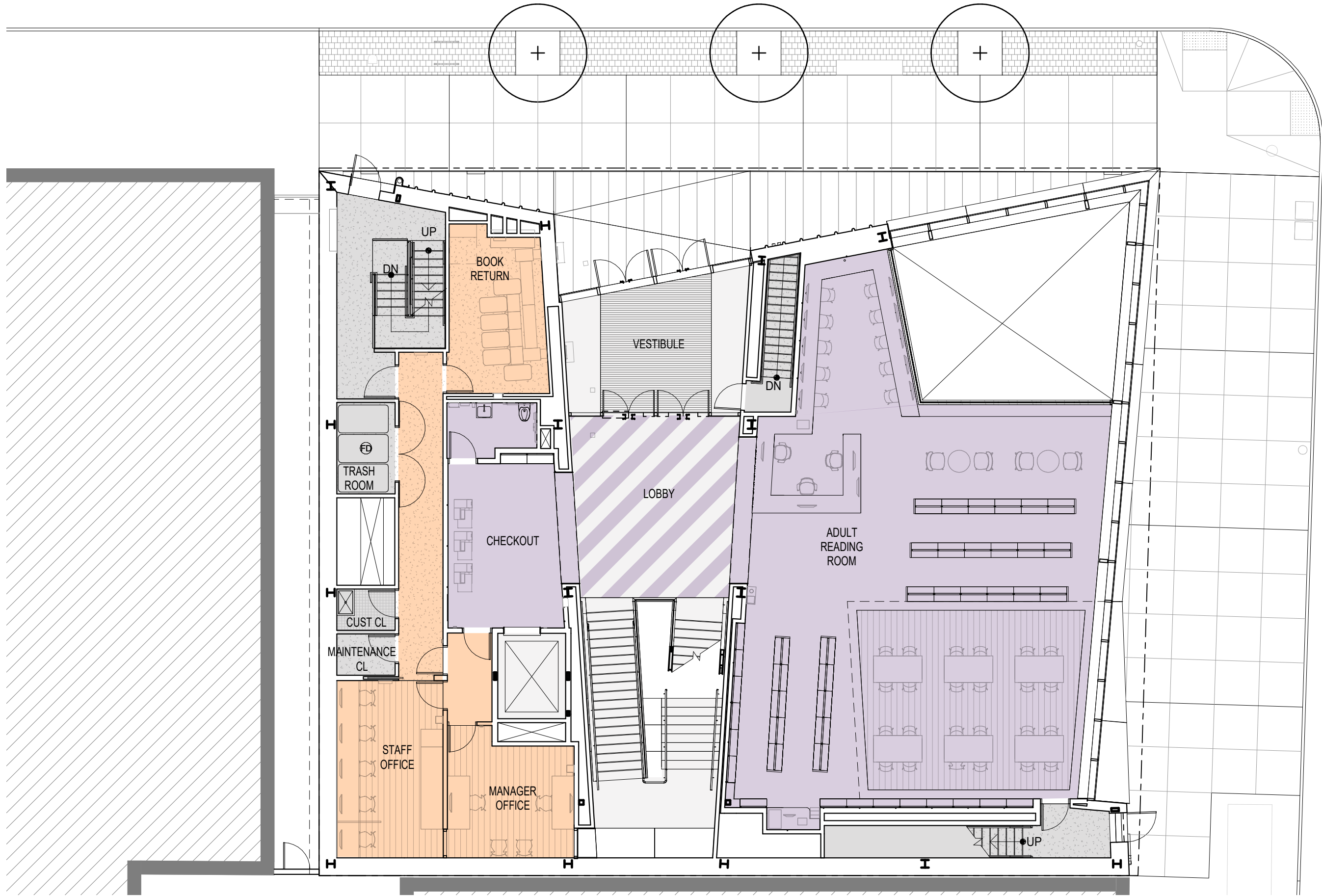

- ADULTS
- CHILDREN
- TEENS
- STAFF
- MULTIPURPOSE
- CIRCULATION
- SERVICES
- PLANTINGS

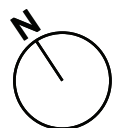

1' 5' 10'



WEISS / MANFREDI
QUEENS PUBLIC LIBRARY / DDC

REGO PARK COMMUNITY LIBRARY
MARCH 28, 2023

PROPOSED RENDERINGS
VIEW OF ADULT READING ROOM

- ADULTS
- CHILDREN
- TEENS
- STAFF
- MULTIPURPOSE
- CIRCULATION
- SERVICES
- PLANTINGS

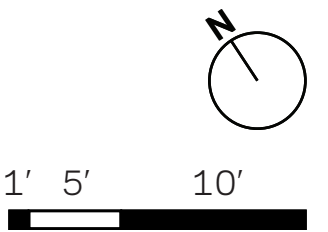
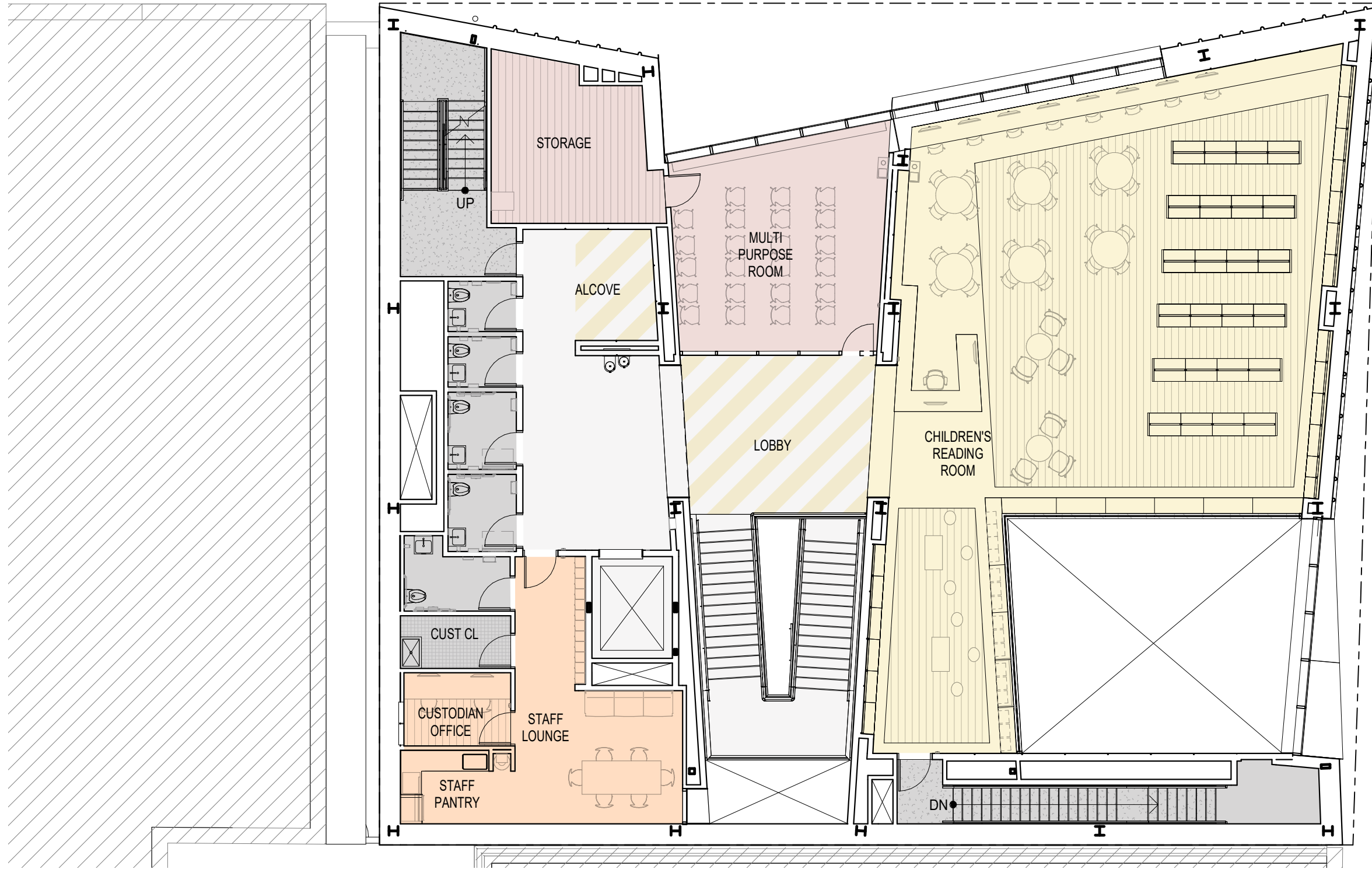



- ADULTS
- CHILDREN
- TEENS
- STAFF
- MULTIPURPOSE
- CIRCULATION
- SERVICES
- PLANTINGS

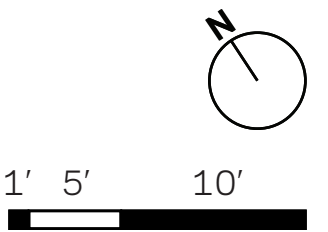
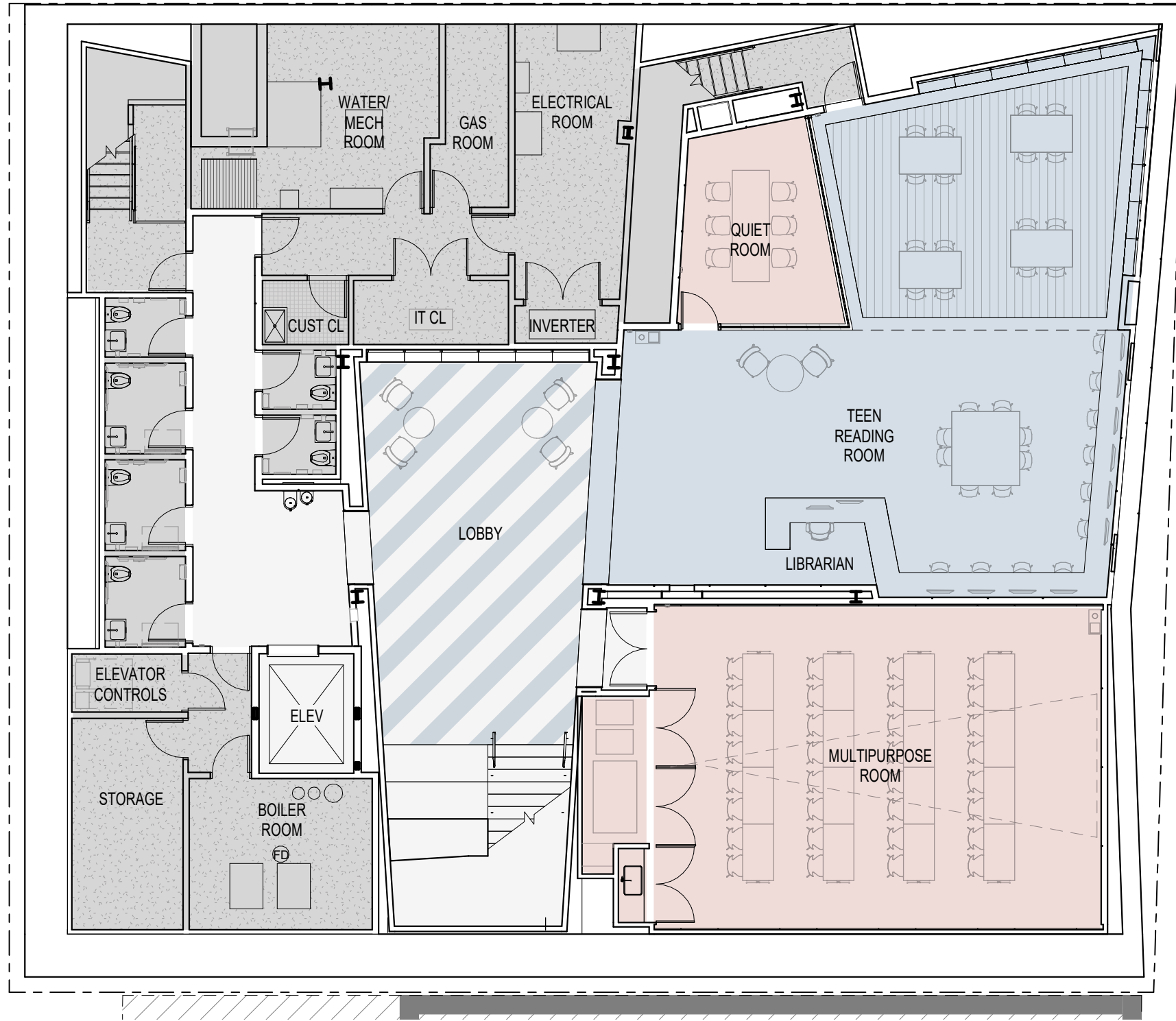
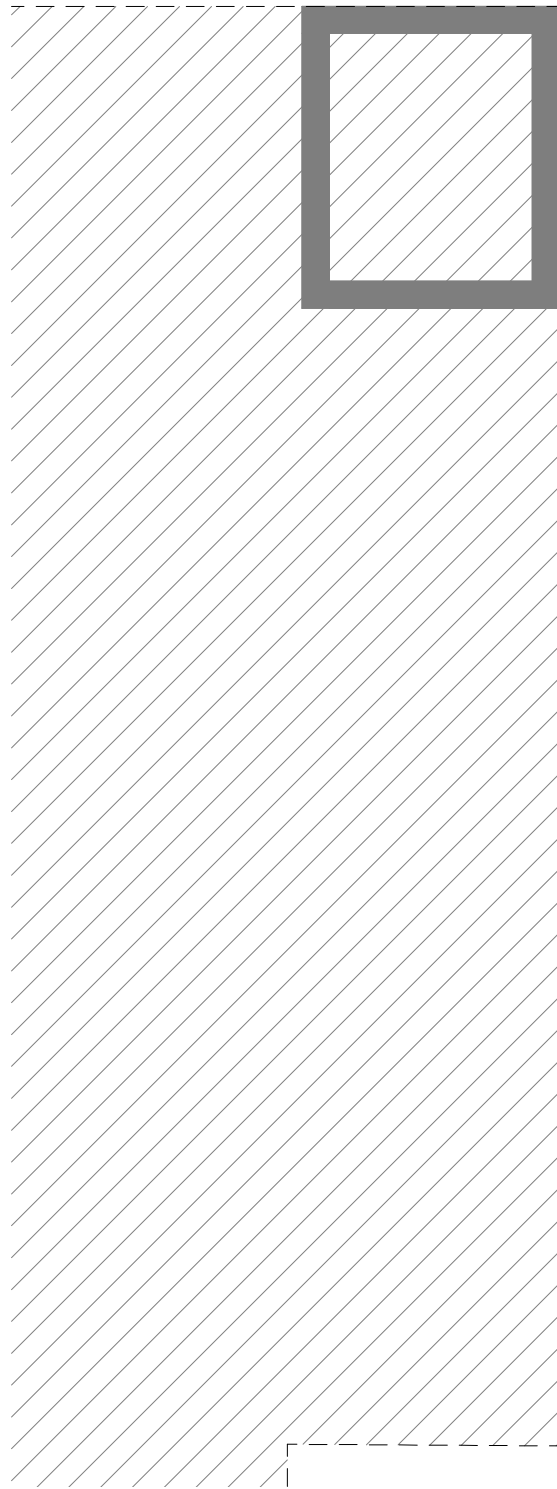





- ADULTS
- CHILDREN
- TEENS
- STAFF
- MULTIPURPOSE
- CIRCULATION
- SERVICES
- PLANTINGS

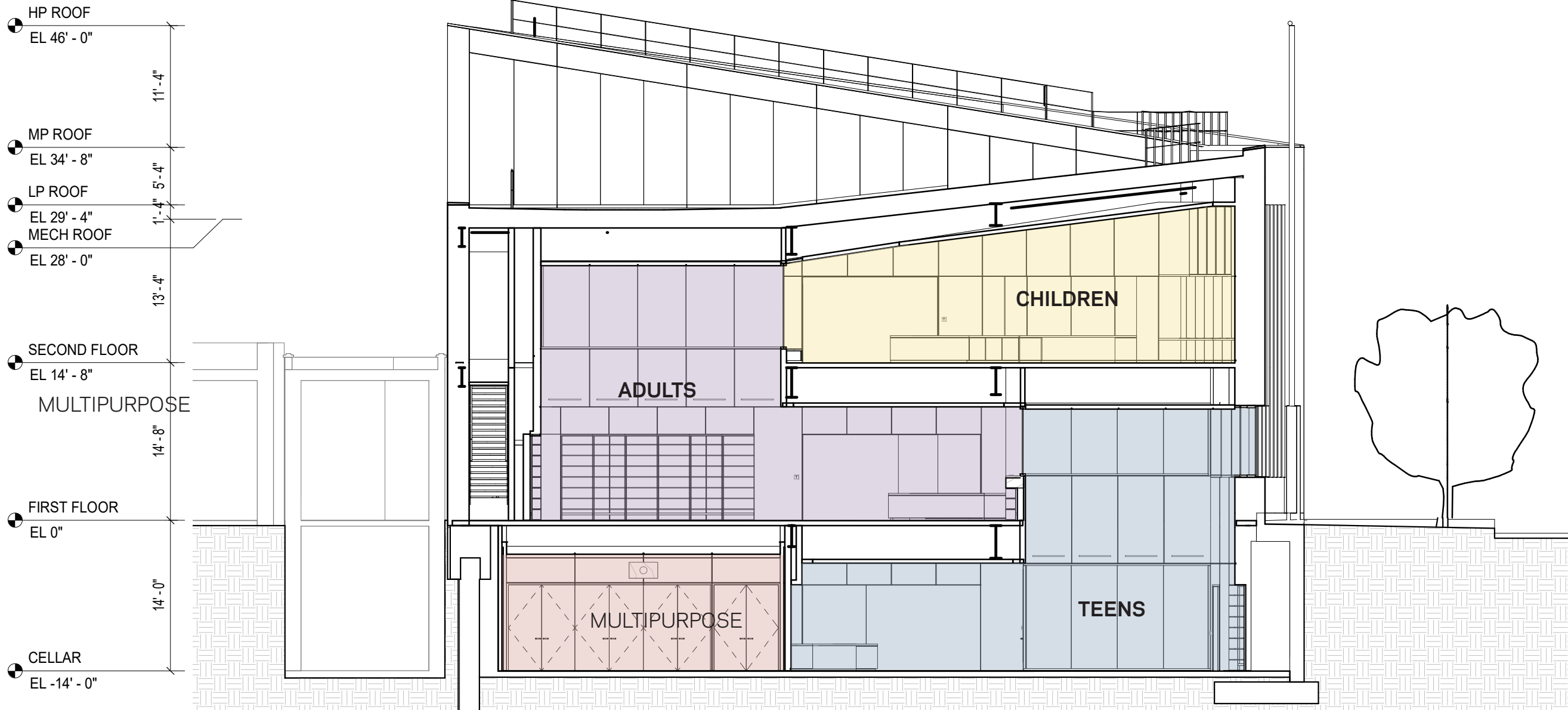

SECTION THROUGH READING ROOMS

- ADULTS
- CHILDREN
- TEENS
- STAFF
- MULTIPURPOSE
- CIRCULATION
- SERVICES
- PLANTINGS

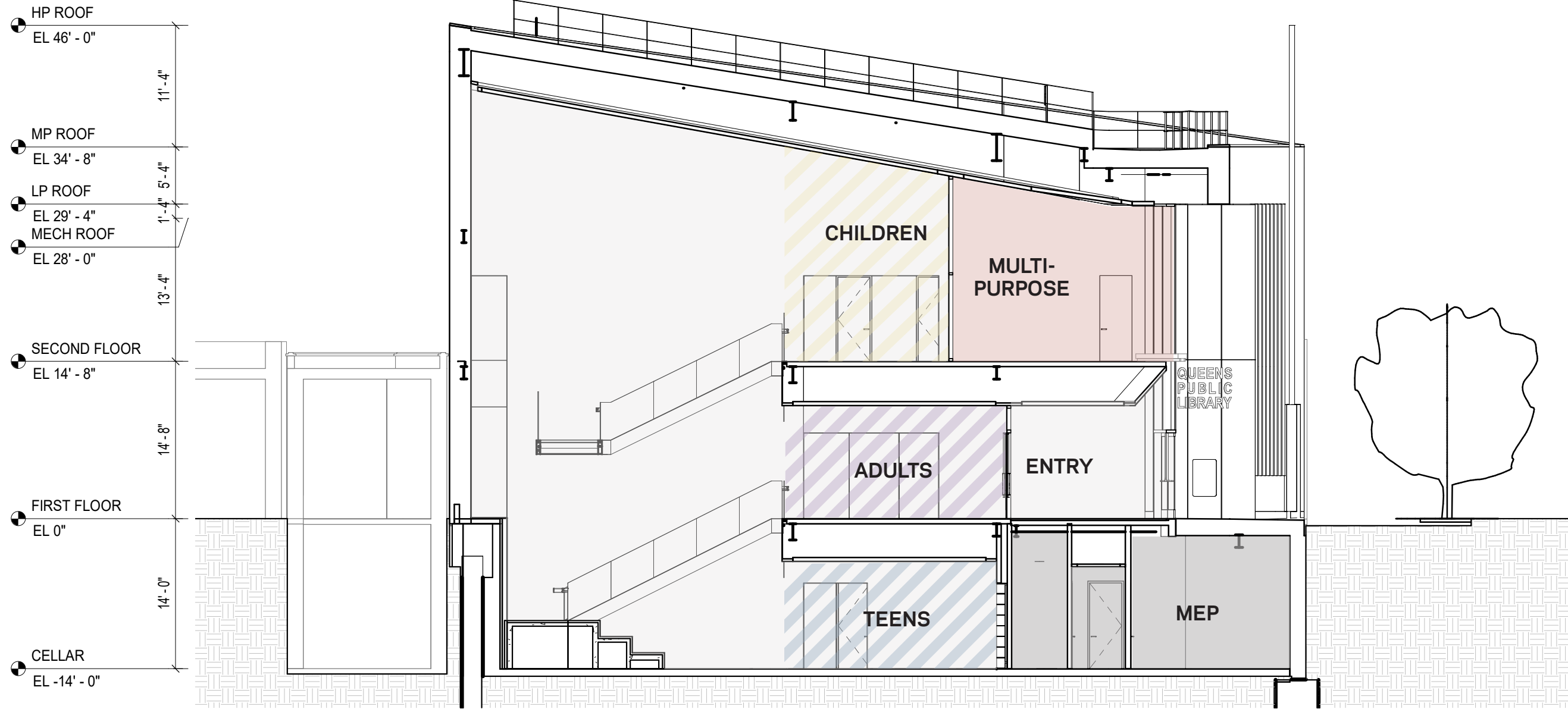

SECTION THROUGH CIRCULATION



WEISS / MANFREDI
QUEENS PUBLIC LIBRARY / DDC

REGO PARK COMMUNITY LIBRARY
MARCH 28, 2023

PROPOSED RENDERINGS
VIEW OF MAIN STAIRCASE AT THE SECOND FLOOR



LOST BATTALION HALL REC CENTER, REGO PARK



HISTORIC DRAKE THEATER, REGO PARK (DEMOLISHED)



RESSURECTION ASCENSION CHURCH, REGO PARK



TUDOR-STYLE HOME + GREEN SLATE ROOF, REGO PARK



TYPICAL COPPER (OXIDIZED) DETAILS, REGO PARK



TYPICAL COPPER (OXIDIZED) DETAILS, REGO PARK





FACADE STUDY - MOTTLED FLAT BRICK

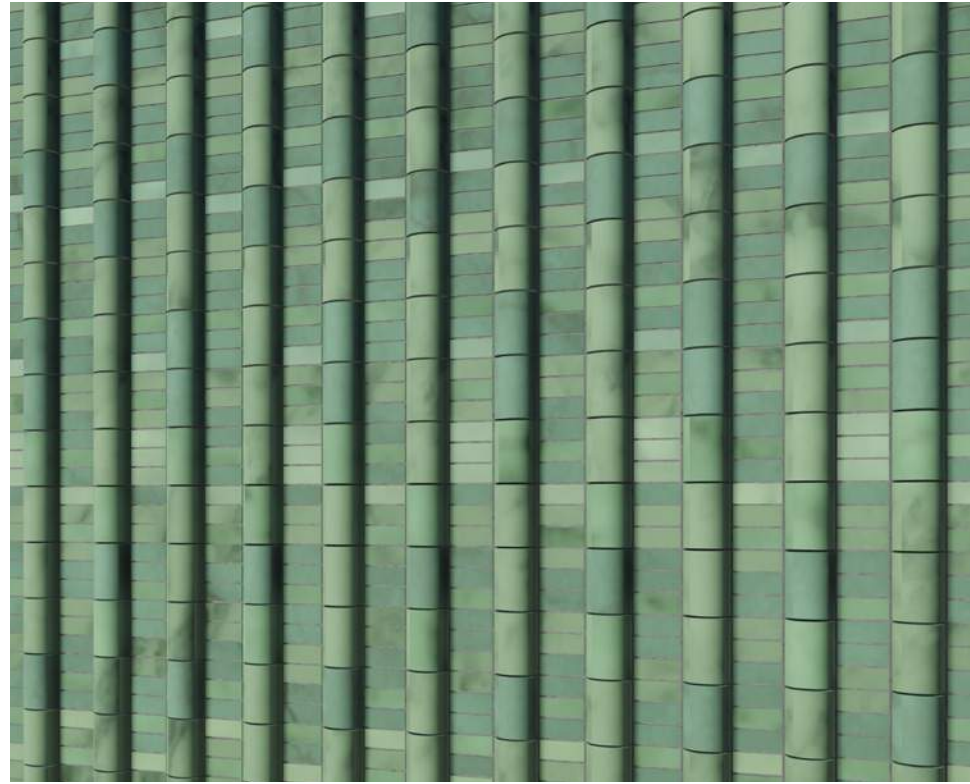

FACADE STUDY - EXTRUDED BRICK

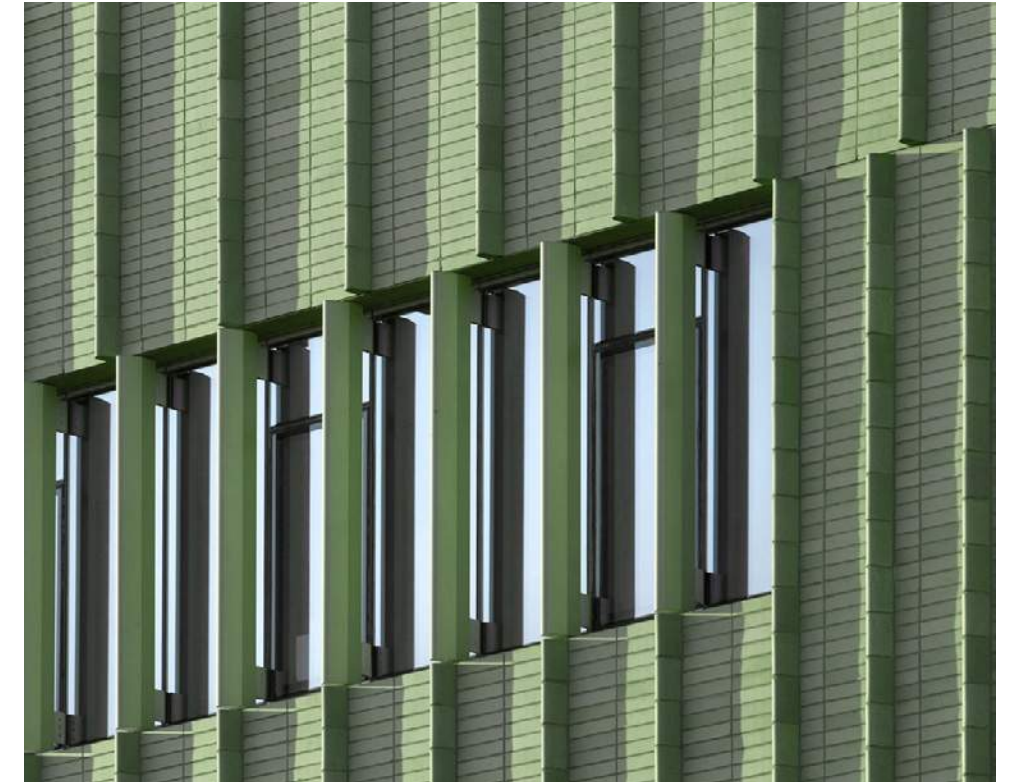

FACADE EXAMPLE - EXTRUDED BRICK



FACADE EXAMPLE - MOTTLED FLAT BRICK

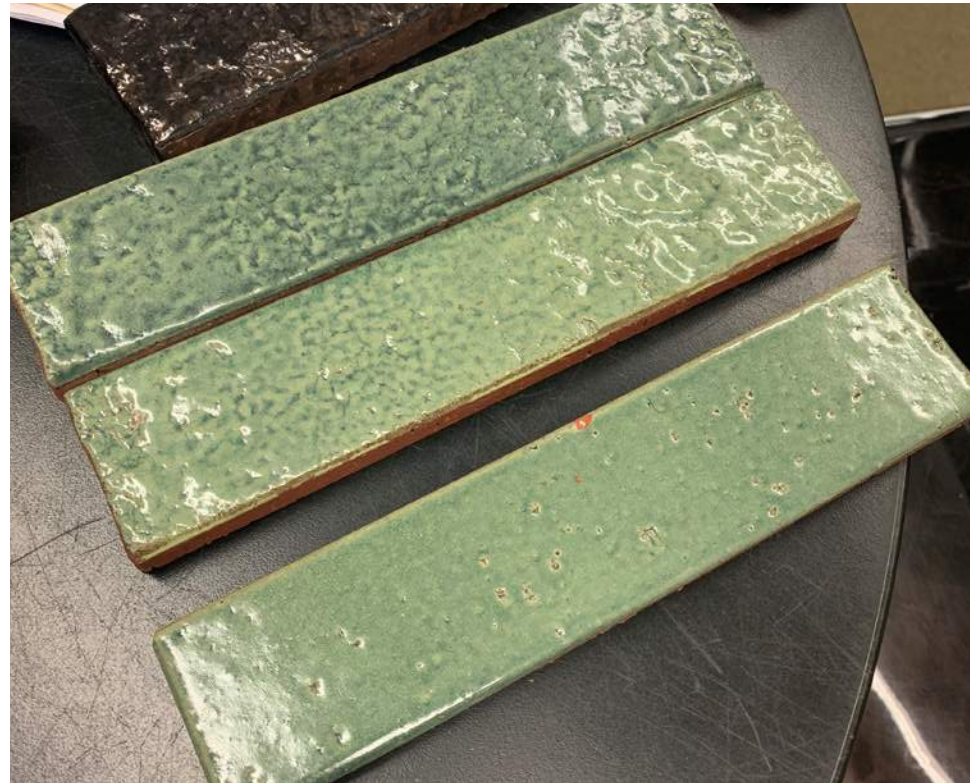

GLAZED BRICK SAMPLES

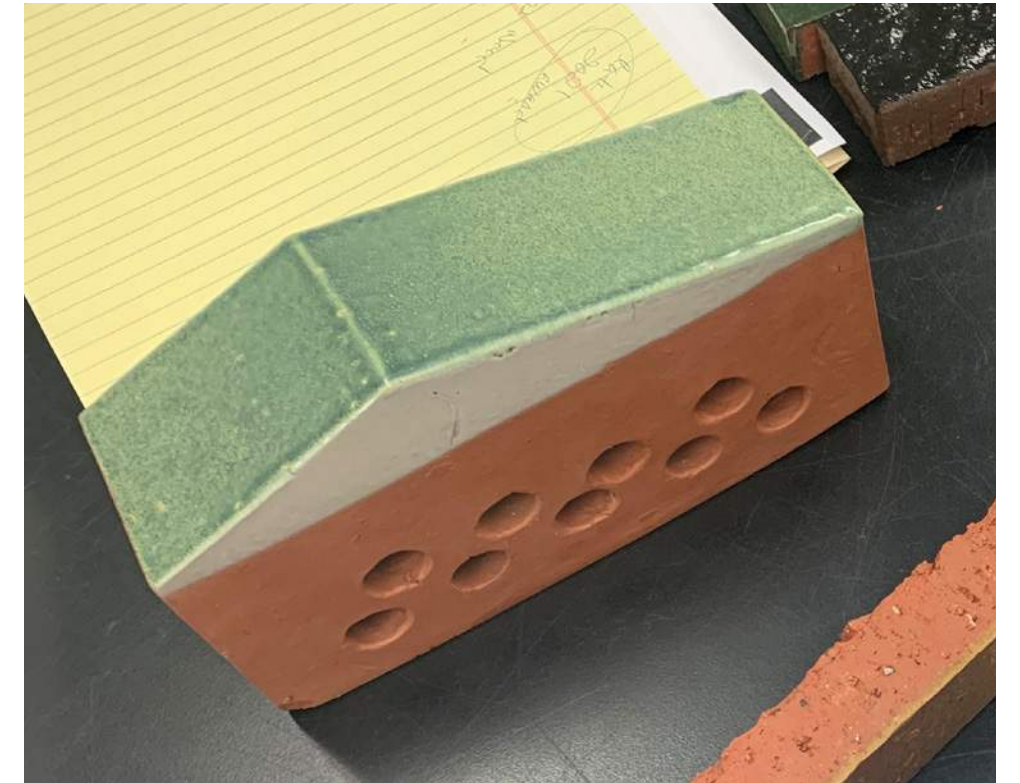

GLAZED BRICK SAMPLES



WEISS / MANFREDI
QUEENS PUBLIC LIBRARY / DDC

REGO PARK COMMUNITY LIBRARY
MARCH 28, 2023

PROPOSED RENDERINGS
VIEW FROM INTERSECTION